

Proportional Valves

Proportional Directional and Throttle Valves – Solenoid Operated

KDG4V-3S and KTG4V-3S standard performance series

K(A)DG4V-3 and K(A)TG4V-3 high performance series

ISO 4401-03 (NFPA D03) – Pressures to 350 bar (5075 psi)



Introduction

KDG and KTG Valves

Vickers KDG and KTG valves are non-feedback type proportional valves.

The KDG is a proportional directional valve with two solenoids (C models). It incorporates control of flow, direction, acceleration, and deceleration in a single control valve.

The KTG is a proportional throttle valve with a single solenoid. B models are spring centered with solenoid A removed. F models are spring offset to port A and respond to an increasing signal by reducing the flow rate. The KTG's spool can be infinitely positioned to achieve throttling (restriction) of the fluid flow.

The primary function of these valves is to direct and meter fluid flow in proportion to current received by the solenoid. This fluid flow controls the velocity, direction, and acceleration or deceleration of a work cylinder or fluid motor.

These valves are designed to fill the performance gap between conventional

solenoid operated directional valves and servo valves or feedback-type proportional valves. They provide control of spool position and metered fluid flow in applications that don't require the high levels of accuracy, repeatability, or response possible with feedback-type proportional valves or servos.

Used with Vickers electronic amplifiers, these valves provide an interface between control system intelligence and hydraulic muscle. This is a very practical way to control actuator direction and speed while eliminating shock caused by rapid acceleration and deceleration of machine loads.

In addition to improving machine performance and life, these proportional valves substantially simplify system design by combining direction and flow control capabilities in one package that mounts to a standard NFPA/ISO subplate or manifold interface.

The valve can also be readily tailored to a vast array of applications by specifying the

specific valve configuration which best meets system requirements.

The valve is controlled by applying current to either solenoid A or solenoid B. This current produces a force at the solenoid push pin which, in turn, causes spool travel. The spool will continue its motion until the solenoid force is balanced by the return spring force. Therefore, spool travel is proportional to the amount of current passing through the solenoid coil.

KADG and KATG Valves

The above description of KDG and KTG valves also applies to KADG and KATG valves, with one exception. "KA" valves have an integral amplifier, whereas KDG and KTG valves do not.

The control amplifier of KA models is housed in a sturdy metal enclosure built directly on, and prewired to, the valve. Factory-set adjustments of gain, balancing deadband and dither ensure high repeatability valve-to-valve. The only electrical inputs required are power supply (24V) and a voltage command signal of $\pm 10V$.

Features and Benefits

These global products, manufactured to world-class quality standards, are sold and serviced throughout the world.

KDG4V and KTG4V valves have a low installed cost due to commonality of parts with Vickers DG4V-3(S) solenoid operated directional valve.

These valves open up expanded application opportunities as a cost-effective alternative to feedback-type proportional and servo valves.

Sustained high machine productivity and uptime result from the proven fatigue life and endurance of reliable KDG4V and KTG4V valves.

Vickers flexible design approach provides optimum performance. A wide variety of matching electronic amplifiers, valve options, and spool ratings allows the system designer flexibility in meeting application requirements.

All valves are NFPA fatigue rated at 350 bar (5075 psi) for improved reliability and performance.

The fully encapsulated solenoid coils are impervious to common industrial fluids. Coils can be removed and replaced quickly and easily without breaking into the hydraulic envelope.

The valves' standard ISO 4401-03 mounting is interchangeable with any NFPA D03 or CETOP 3 interface.

The engineering resin junction box is NEMA 4 rated for resistance to water and all commonly used industrial fluids.

Advantages of KADG and KATG valves with integral amplifier:

Factory-sealed adjustments for increased valve-to-valve accuracy and simplified system set-up. Valve and amplifier selected, ordered, delivered and installed as a performance-tested package.

Installation wiring reduced and simplified.

Simplified valve removal and replacement.

The use of Viton* O-rings throughout provides multi-fluid capability and prevents outside fluids from contacting internal valve parts.

* Viton is a registered trademark of the DuPont Co.

Contents

General Information

Typical Applications, Meter-in and Meter-out, Valve Spool Position, Flow Rates, Recommended Fluids, Pressure Compensation, Accessories, Electrical Signals, Electrical Connectors	4
Cross Section of Typical Valve, Graphical Symbols	5

System Calculations for Valve Selection6

KDG4V-3S and KTG4V-3S Standard Performance Valves –100 bar (1450 psi) tank line rating

Model Code	7
Application Data	
Specifications, Performance, Solenoid Specifications, Step Response Time	
Spool, Spool/Spring, Metering, Amplifiers, Drain	8
Flow Paths	9
Flow Gain Curves	10
Power Capacity Envelopes	13
Frequency Response	14
Installation Dimensions	15
EN-427 Feature	16
Electrical Connections	17

K(A)DG4V-3 and K(A)TG4V-3 High Performance Valves –210 bar (3000 psi) tank line rating

Model Code	18
Application Data	
Specifications, Performance, Solenoid Specifications, Step Input Time, Amplifiers, Drain	19
Flow Paths	21
Flow Gain Curves	22
Power Capacity Envelopes	26
Frequency Response	27
Electrical Block Diagram for KADG4V-3 and KATG4V-3	28
Connection Arrangements for KADG4V-3 and KATG4V-3	29
Installation Dimensions	30

Mounting Requirements32

Fluid Cleanliness33

General Information

Typical Applications

This type of valve is often used in both mobile and industrial “line-of-sight” applications where speed and position are controlled by an operator. Some examples are aerial work platforms, entertainment industry rides, farm combine controls, material handling equipment, and process controls. Any application using a DG4V-3(S) 60-design solenoid operated directional valve is a potential application for the KDG4V-3(S) or KTG4V-3(S)

The standard performance KDG4V-3S or KTG4V-3S should be used on most applications where a tank line pressure rating of 100 bar (1450 psi) is acceptable. The high performance KDG4V-3 or KTG4V-3 should be used on applications where a tank line pressure rating of 210 bar (3000 psi) is required.

Commonly used electrical input devices include joystick controllers, proportional push buttons, potentiometers, power plugs, and amplifier cards. Input devices that operate on the principle of direct voltage rather than current control will require the appropriate coil type (GP or HA).

Meter-in and Meter-out

System requirements must be clearly understood and taken into consideration when selecting a valve spool. Meter-out spools have the metering notches positioned between the actuator port and the tank port, creating a throttle in the hydraulic actuator’s return line. Meter-out is the most common spool configuration and is typically used in applications with over center loads and/or requiring deceleration control.

Meter-in spools have the metering notches positioned between the pressure port and the actuator port, creating a throttle in the hydraulic actuator’s inlet line. Meter-in spools are commonly used with hydrostat modules for pressure compensation in applications that don’t have an overrunning load as well as in load sensing pump circuits.

Spools with both meter-in and meter-out flow characteristics should be specified in applications where load changes (resistive to overrunning or vice versa) will occur. They should also be selected when uncertain system dynamics prevent the selection of specific meter-in or meter-out spool types.

Valve Spool Position

Spring centered and spring offset valves will be spring positioned unless the solenoid is energized continuously.

NOTE

Due to silting, any sliding spool valve held shifted under pressure for long periods may stick and not spring return. It is recommended that such valves be cycled periodically to prevent this from occurring.

Flow Rates

The rate of flow through a proportional valve is dependent on spool position and valve pressure differential. This is similar to flow through a needle valve. Like a needle valve, as a proportional valve is opened, the rate of flow increases, and if the pressure differential across the valve changes (because of load pressure changes, for example), the flow will vary. Because of this phenomenon, “rated flow” is an arbitrary term, dependent on the above parameters.

Unlike a needle valve, however, proportional valves exhibit an inherent degree of load compensation whereby increasing valve pressure drop has progressively less effect on flow rate (see Power Capacity Envelopes on pages 13 and 26). To eliminate the effects of pressure changes, a hydrostat module can be installed under the proportional valve to achieve pressure compensation.

Recommended Fluids

Petroleum oils are recommended for use with the KDG4V and KTG4V. Fluorocarbon seals are standard and are suitable for use with phosphate ester type fluids or blends, water glycol, water-in-oil emulsion fluids, and petroleum oils. Refer to publication 694 for fluid and temperature recommendations. HWBF (95% water) is not recommended.

Pressure Compensation

For information on using a SystemStak reducing valve to achieve pressure compensation control, please contact your Vickers Representative.

Accessories

See page 32 for information on mounting surface, subplate, and bolt kits.

Electrical Signals

It is important to note that solenoid force and valve flow are proportional to current—not voltage. Therefore, for optimum performance, a constant current electrical signal should be used. This type of signal will help compensate for the drift that would otherwise occur when current flow causes solenoid temperature and resistance to increase.

Flow is metered directly in proportion to the command signal applied to the amplifier. Metering performance is enhanced by machined metering notches on the valve spool. As the spool travels from its centered position, these metering notches create an increasingly greater orifice area, allowing more fluid to pass.

Electrical Connectors

KDG4V-3S and KTG4V-3S

On FT (flying lead) models, electrical connections to the valve are made in the wiring housing, and a ground terminal is provided. SP1 and SP2 models have spade type terminals on each solenoid. DIN 43650 connectors are also available by specifying the U coil type. When U1 is specified, DIN 443650 mating plugs are included.

KDG4V-3 and KTG4V-3

DIN 43650 connectors are standard. Mating plugs must be ordered separately.

Cross Section of Typical Valve (KTG4V-3S)

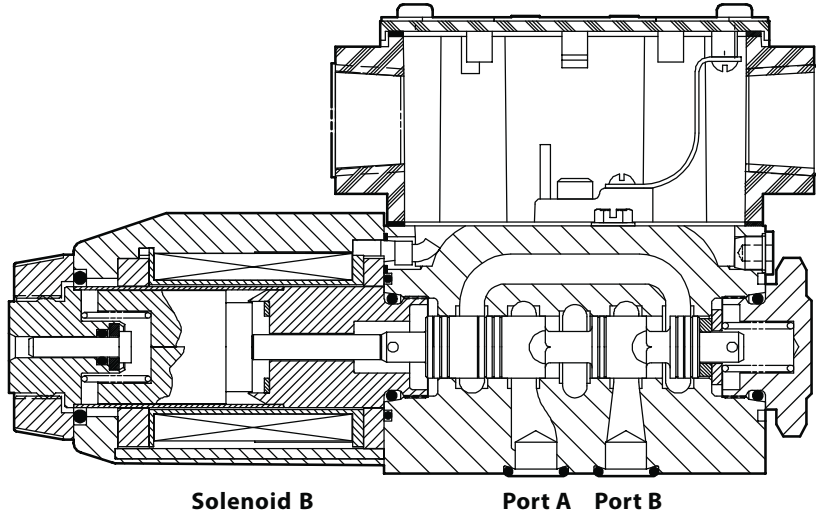

Graphical Symbols

KTG4V

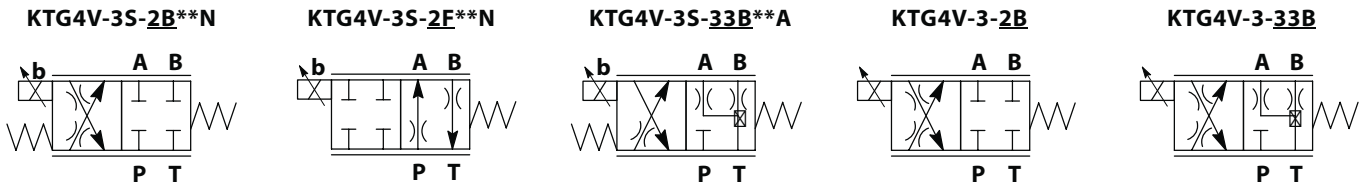

KDG4V

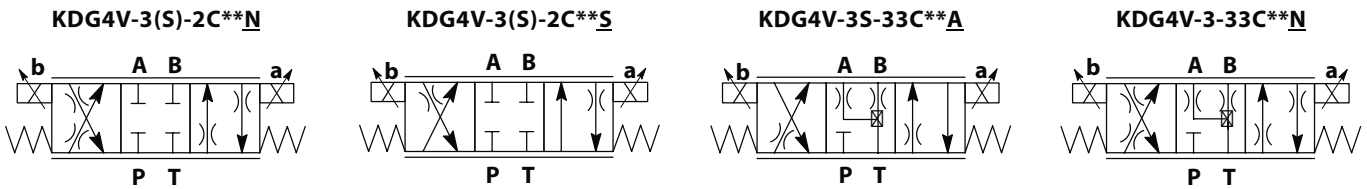

Note: on all models, when solenoid "a" is energized, flow is always "P" to "A". When solenoid "b" is energized, flow is always "P" to "B". This is in accordance with the ANSI-B93.9 standard. Solenoid designations "a" and "b" are identified on the diagram plate on the side of the valve.

System Calculations for Valve Selection

The "rated flow" values for this range of proportional valves are determined with a looped flow path pressure drop (e.g. P→A→B→T) of 10 bar (145 psi) when the valve is fully open. As explained on page 4, however, "rated flow" is an arbitrary term dependent upon external factors.

It is important to properly size a proportional valve to achieve good resolution. A common mistake in specifying proportional valves is selecting too high a rated flow. The result may be poor control of the actuator, particularly with respect to velocity and resolution. The ideal valve size is usually one that provides just enough maximum flow to achieve the required actuator velocity.

The following steps can be used to determine the proper size for a proportional valve. This procedure applies to a conventional four-way valve controlling an equal area piston driving a load in an application in which velocity is the critical parameter. For differential area cylinders, base the calculations on the maximum cylinder flow rate.

Constants

- A = Actuator piston area, cm² (in²)
- F_M = Maximum force required, N (lbf)
- F_D = Force required to accelerate and maintain velocity, N (lbf)
- P_S = Supply pressure less other system pressure drops, bar (psi)
- P_L = Maximum pressure required to drive or accelerate actuator under dynamic conditions, bar (psi)
- P_V = Allowable valve pressure drop, bar (psi)
- V = Desired actuator velocity, m/s (in/s)
- Q = Flow required to drive actuator at desired velocity, L/min (USgpm)

1. Determine required actuator area:

$$A(\text{cm}^2) = \frac{F_M(\text{N})}{10 \times P_S(\text{bar})}$$

$$\left[A(\text{in}^2) = \frac{F_M(\text{lbf})}{P_S(\text{psi})} \right]$$

2. Determine flow required to drive actuator at desired velocity:

$$Q(\text{L/min}) = 6 \times A(\text{cm}^2) \times V(\text{m/s})$$

$$\left[Q(\text{USgpm}) = \frac{A(\text{in}^2) \times V(\text{in/s})}{3.85} \right]$$

3. Determine maximum load pressure drop under dynamic conditions:

$$P_L(\text{bar}) = \frac{F_D(\text{N})}{10 \times A(\text{cm}^2)}$$

$$\left[P_L(\text{psi}) = \frac{F_D(\text{lbf})}{A(\text{in}^2)} \right]$$

4. Determine valve pressure drop:

$$P_V(\text{bar}) = P_S(\text{bar}) - P_L(\text{bar})$$

$$\left[P_V(\text{psi}) = P_S(\text{psi}) - P_L(\text{psi}) \right]$$

5. Refer to Flow Gain Curves starting on page 10 and determine most suitable valve spool based on flow (Q) and pressure drop (P_V).

6. Refer to Power Capacity Envelopes on page 13 and verify that flow (Q) determined in step 2 at the valve pressure drop (P_V) determined in step 4 falls within (to the left of) the power curve for the spool selected in step 5.

Example

A hydraulic system consisting of a pressure compensated pump, proportional valve, and equal area cylinder must develop a maximum force of 6400 N (1440 lbf) and move a 200 N (45 lbf) load at a velocity of 0,25 m/s (9.84 in/s). The force required to maintain this velocity is 1000 N (225 lb), and the pump's compensator is set at 60 bar (870 psi).

1. Determine required actuator area:

$$A = \frac{F_M}{10 \times P_S} = \frac{6400}{10 \times 60} = 10,7 \text{ cm}^2$$

$$\left[A = \frac{F_M}{P_S} = \frac{1440}{870} = 1.66 \text{ in}^2 \right]$$

* 2 inch bore, 1.375 inch rod cylinder has actuator area = 1.66 in²

2. Determine flow required to drive actuator at desired velocity:

$$Q = 6 \times A \times V = 6 \times 10,7 \times 0,25 = 16,1 \text{ L/min}$$

$$\left[Q = \frac{A \times V}{3.85} = \frac{1.66 \times 9.84}{3.85} = 4.24 \text{ USgpm} \right]$$

3. Determine maximum load pressure drop under dynamic conditions:

$$P_L = \frac{F_D}{10 \times A} = \frac{1000}{10 \times 10,7} = 9,4 \text{ bar}$$

$$\left[P_L = \frac{F_D}{A} = \frac{225}{1.66} = 136 \text{ psi} \right]$$

4. Determine valve pressure drop:

$$P_V = P_S - P_L = 60 - 9,4 = 50,6 \text{ bar}$$

$$\left[P_V = P_S - P_L = 800 - 136 = 734 \text{ psi} \right]$$

5. Refer to Flow Gain Curves and determine most suitable valve spool based on flow (Q) and pressure drop (P_V):

Calculated flow (Q) is 16,1 L/min (4.24 USgpm), and valve pressure drop (P_V) is 50,6 bar (734 psi). Reference to the KDG4V-3S "Flow Gain" graphs (see page 10) shows that the 15N spool (meter-in and meter-out) will do the job. A KDG4V-3S-2C15N would be selected.

Model Code –K*G4V-3S Standard Performance Valves

K * G 4 V - 3 S - * * * (L) * * * - (* *) - (V) M * * * * * * * (1) - * * 5 - 60 - (EN * *)

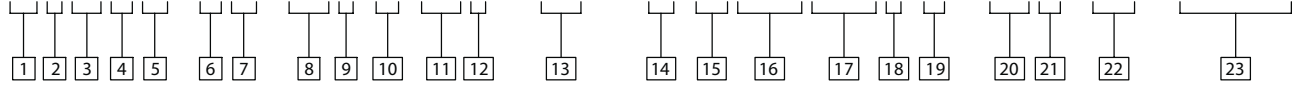

1 Valve type

K – Proportional

2 Valve function

D – Directional valve (Double solenoid, C models. See item 9.)
T – Throttle valve (Single solenoid, B and F models. See item 9.)

3 Mounting

G – Subplate/manifold mounted

4 Operation

4 – Solenoid operated

5 Pressure rating

V – 350 bar (5075 psi) on P, A, and B ports

6 Interface

3 – ISO 4401-03, CETOP 3 (NFPA D03)

7 Performance

S – Standard performance

8 Spool type (center condition)

2 – Closed center (all ports)
33 – P port closed, bleed A and B to T

9 Spool/spring arrangement

B – Spring centered, solenoid A removed
C – Spring centered, dual solenoid
F – Spring offset to A port, shift to center

10 Build

L – Left-hand build (single solenoid only)
Blank – Standard right-hand build

11 Spool flow rating

For looped flow path P→A→B→T or P→B→A→T: Δ p=10 bar (145 psid).
For single flow path P→A or B→T: Δ p= 5 bar (72 psi).

08 – 8 L/min (2 USgpm)
15 – 15 L/min (4 USgpm)
19 – 19 L/min (5 USgpm)
22 – 22 L/min (5.8 USgpm) – available with KDG4V-3S-33C22A only

12 Metering condition

S – Meter out only
A – Meter in only
N – Meter in and meter out

Note: See table on page 8 for available combinations of spools, spool/spring arrangements, and metering conditions.

13 Manual override

P2 – Plain override in both ends of single solenoid models
H – Waterproof override in solenoid ends only
Blank – Plain override in solenoid ends only

14 Solenoid energization identity

V – Solenoid identification determined by position of solenoid (solenoid A on A port end, solenoid B on B port end)
Blank – Standard per ANSI B93.9 (energize solenoid A, flow is (P→A))

15 Flag symbol

M – Electrical options and features

16 Coil type

F – Flying lead and wiring box
U – DIN 43650 connector
SP1 – Single 6,3 mm spade IEC-760 (direct DC only)
SP2 – Dual 6,3 mm spade IEC-760

17 Electrical connections

T – Wiring terminal block
PA3 – 3-pin conduit connector
PA5 – 5-pin conduit connector

18 Wiring housing thread

W – 1/2" NPT
J – 20 mm

19 Electrical options

1 – ISO 4400 with DIN 43650 plug supplied (U coil type models only)

20 Coil voltage rating

G – 12V DC*
H – 24V DC*
GP – Direct 12V DC or EM-VP/VT amplifier
HA – Direct 24V DC or EM-VP/VT amplifier

* Amplified models, current controlled

21 Tank pressure rating

5 – 100 bar (1450 psi) for

22 Design number

Subject to change.

23 Special modifications

EN-427 – Applies to KTG4V only. One spool designation only and preset adjuster; see page 16.

Note: This valve is recommended for use with Vickers Valvistor control valve.

KDG4V-3S and KTG4V-3S Application Data

Specifications

Maximum operating pressure (A, B and P ports)

350 bar (5000 psi)
(See "Flow Gain Curves")

Maximum tank line pressure (T port)

K*G4V-3S:100 bar (1450 psi)

Maximum recommended pressure drop (four-way models at max. flow)

210 bar (3000psi)*

*At pressure drops above 10 bar (145 psid) dither amplitudes in the electronic controller may need to be set at or near minimum to eliminate potential high frequency circuit noise.

Mounting pattern

ISO-4401-AB-03-4-A, NFPA D03, CETOP 3

Operating temp . . . 20 to 82C
(-4 to 180F)

Fluid viscosity . . . 16 – 54 cSt (75–250 SUS)

Weights (approximate)

KDG4V-3S-*–60 . . .2,3 kg (5.06 lbs.)
KTG4V-3S-*–60 . . .1,75 kg (3.85 lbs.)

Performance

Frequency Response

18Hz @ -3db
(10Hz @ 45 degree phase lag)
For an amplitude of 25% max stroke (center to offset) about the 50% position and ΔP (P-A-B-T) = 10 bar (145 psid). See graph on page 14.

Hysteresis

With pulse width modulation: 4%
With direct DC voltage (GP & HA): 8%

Repeatability: 1%

Deadband : 15–35%
of full solenoid input. Vickers electronic controllers have a deadband eliminator to reduce this value to near zero.

Solenoid Specifications

Maximum current @ 50C (122F) ambient

G 3.2A
H 1.6A

Power Consumption @ 20C (68F)

G 18 Watts
H 18 Watts
GP 30 Watts
HA 30 Watts

Coil Resistance @ 20C (68F)

G 1.8 Ohms
H 7.3 Ohms
GP 4.9 Ohms
HA 19.6 Ohms

Coil Inductance @ 1000 Hz

G 7.5mH
H 29mH
GP 16mH
HA 67 mH

Step Response Time

The following response times were measured from the point of energization/de-energization to the point of first indication of inlet pressure change.

Response up to full system pressure is dependent on the system's compressed volume and can vary with each application.

0–100% (center to full spool travel)
100 msec

100–0% (full spool travel to center – fast drop out)
15 msec

10–90% (10% full flow to 90% full flow)
100 msec

90–10% (90% full flow to 10% full flow)
25 msec

100–100% (100% full flow travel in one direction to 100 % full flow travel in the reverse direction)
80 msec

Spool, Spool/Spring, Metering

Refer to the table below for the available spools, spool/spring arrangements and metering conditions.

For example, if a KD valve with a "33" spool is required, the spool/spring arrangement is "C" and the metering condition available is "A". Refer to "Model Code" for a definition of these codes.

Model	Spool	Spool/Spring Arrangement	Metering Condition
KD	2	C	Nor S
	33	C	A
KT	2	Bor F	N
	33	B	A

Amplifiers

Coil Voltage Identification Letter	Amplifier
H	EEA-PAM -523-A-32
	EEA-PAM -523-B-32
	EEA-PAM -523-C-32
	EEA-PAM -523-D-32
	EEA-PAM -523-E-32
	EEA-PAM -523-F-3 2
H	EEA-PAM -520-A-14 (for use with EN427 models)
GP	EM-VT-12-10 ¹
	EM-VP-12-10 ¹
HA	EM-VT-24-10 ¹
	EM-VP-24-10 ¹
Plug Amplifier	
G	EHH-AMP-712-D/G-20
H	EHH-AMP-702-C-20
	EHH-AMP-702-D-20
	EHH-AMP-702-E-20
	EHH-AMP-702-F-20

¹ Refer to drawing I-521575 for information.

Drain

On 2-way valves, "T" is the drain and must be connected to the tank through a surge-free line, so there will be no back pressure at this port.

KDG4V-3S and KTG4V-3S Flow Paths

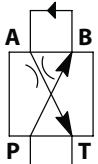
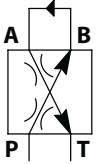
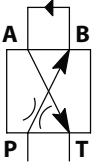
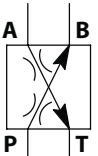
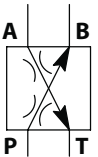
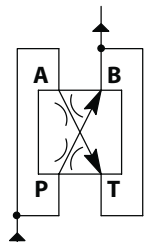
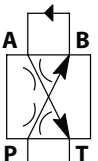
Valve/Flow Path	Spool	Symbol
KDG4V-3S with Looped Flow Path. P→A or B, plus B→A→T	2C08S 2C15S 2C19S	
	2C08N 2C15N 2C19N	
	33C08A 33C15A 33C22A	
KDG4V-3S with Single Flow Path. P→A or B, or A or B→T	2C08N 2C15N 2C19N	
KTG4V-3S with Single Flow Path. P→A or B, or A or B→T	2B08N 2B15N 2B19N	
KTG4V-3S with Parallel Flow Path. P→B and A→T	2B08N 2B15N 2B19N	
KTG4V-3S with Looped Flow Path. P→A or B, plus B→A→T	2B08N 2B15N 2B19N	

KDG4V-3S Flow Gain Curves

At the stated valve pressure drops, the percentage command signals are applicable to whichever solenoid is energized.

Looped Flow Path

USgpm l/min Spool "2C08S" P-A or B plus B or A-T

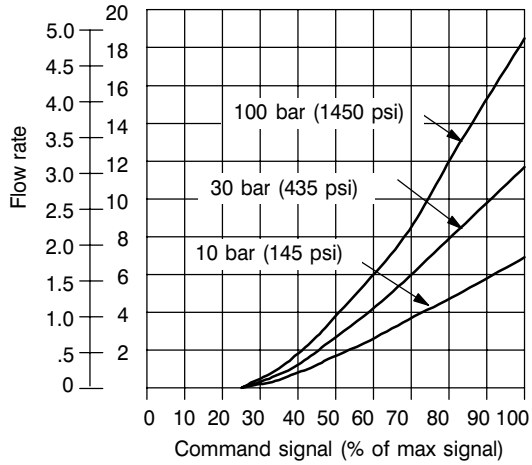

Looped Flow Path

USgpm l/min Spool "2C08N" P-A or B, or A or B-T

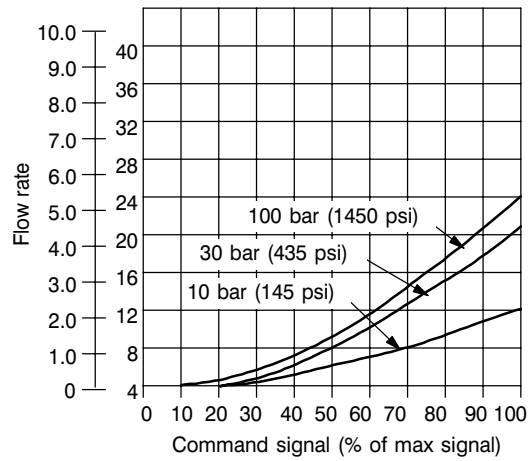

USgpm l/min Spool "2C15S" P-A or B plus B or A-T

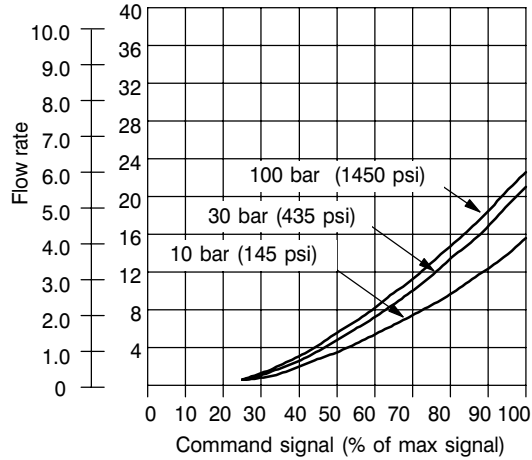

USgpm l/min Spool "2C15N" P-A or B, or A or B-T

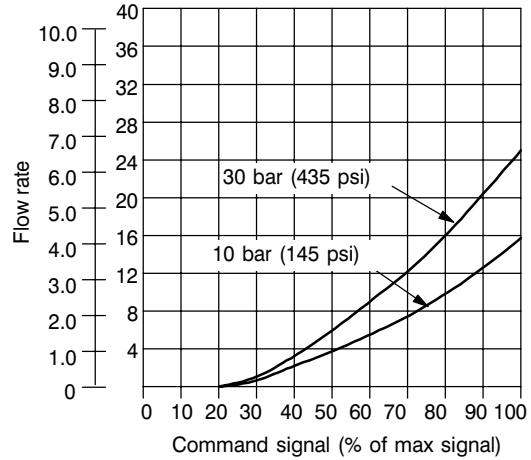

USgpm l/min Spool "2C19S" P-A or B plus B or A-T

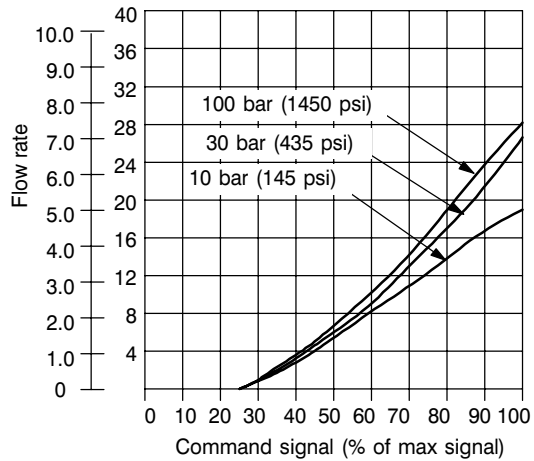

USgpm l/min Spool "2C19N" P-A or B, or A or B-T

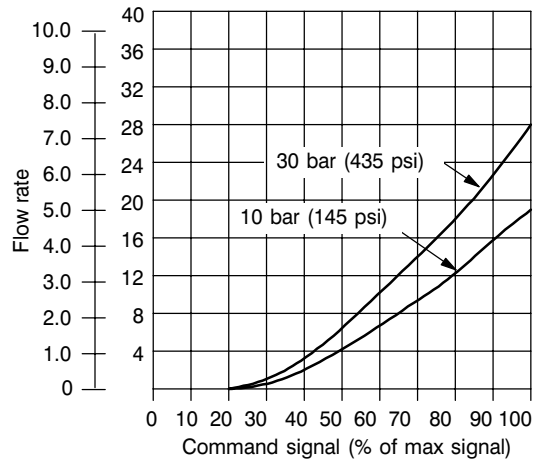

At the stated valve pressure drops, the percentage command signals are applicable to whichever solenoid is energized.

Looped Flow Path

USgpm l/min Spool "33C08A" P-A or B plus B or A-T

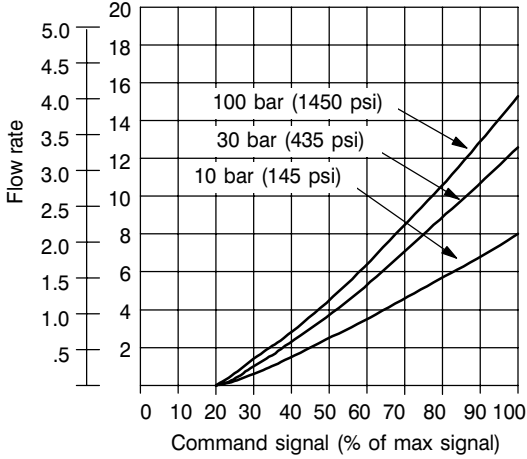

Single Flow Path

USgpm l/min Spool "2C08N" P-B or A-T

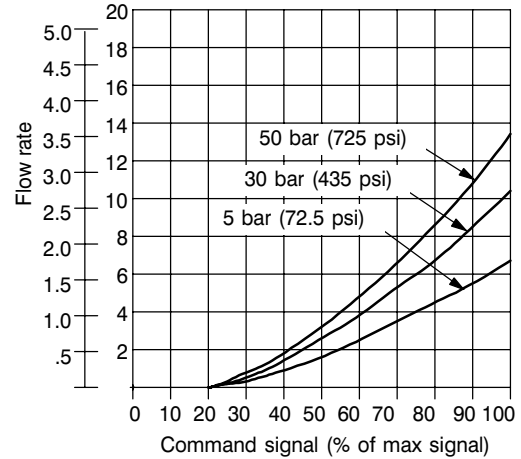

USgpm l/min Spool "33C15A" P-A or B plus B or A-T

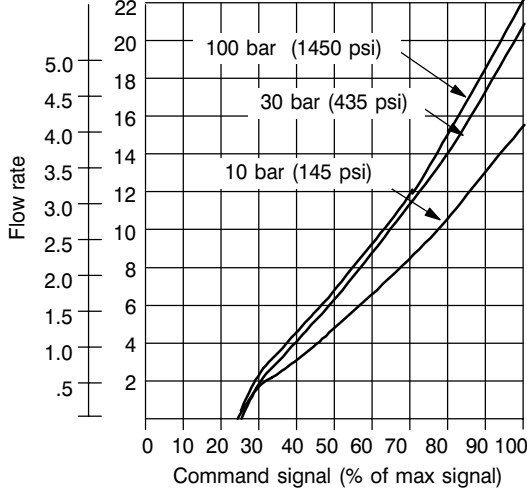

USgpm l/min Spool "2C15N" P-B or A-T

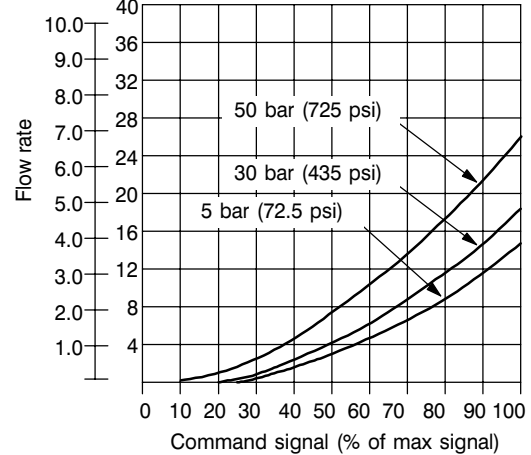

USgpm l/min Spool "33C22A" P-A or B plus B or A-T

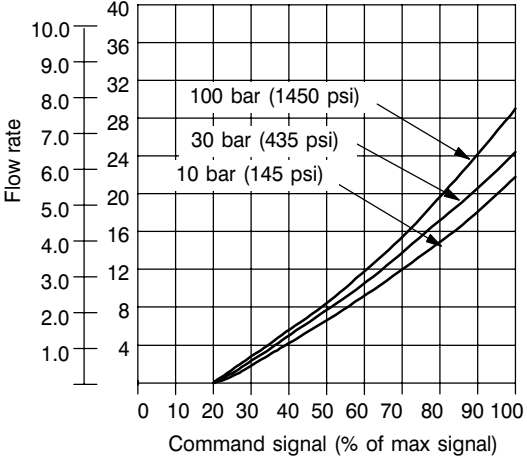

USgpm l/min Spool "2C19N" P-B or A-T

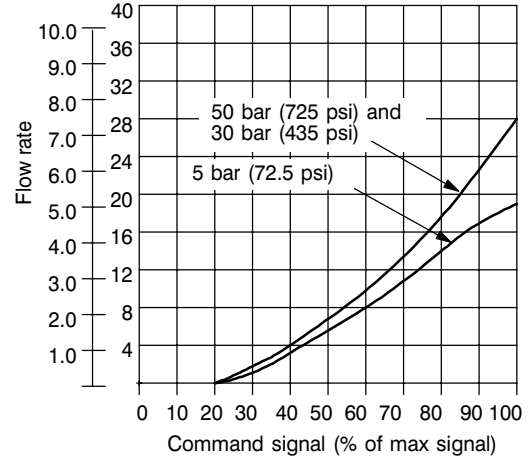

KDG4V-3S Flow Gain Curves

At the stated valve pressure drops, the percentage command signals are applicable to whichever solenoid is energized.

Single Flow Path

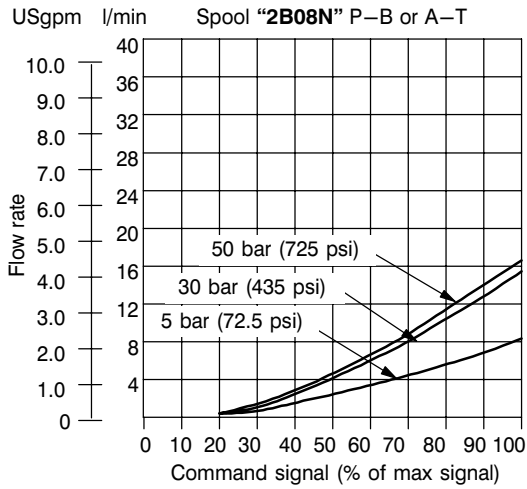

Parallel Flow Path

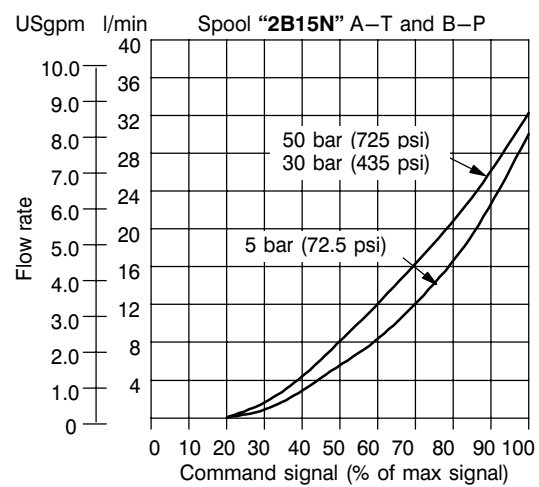
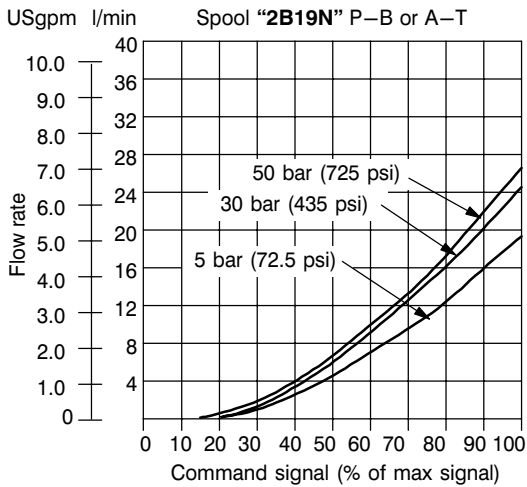
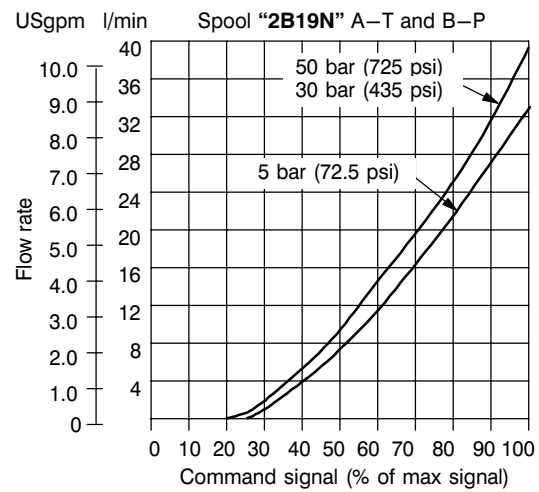
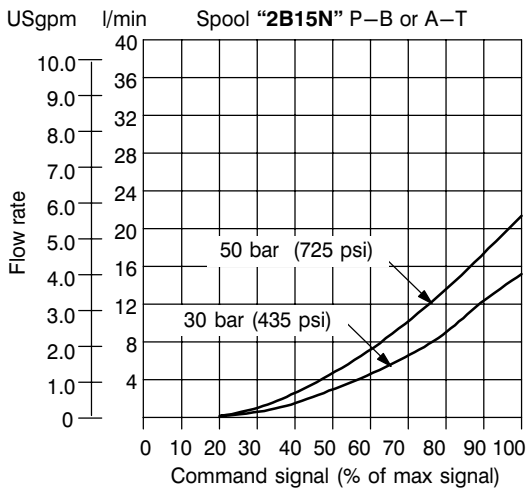
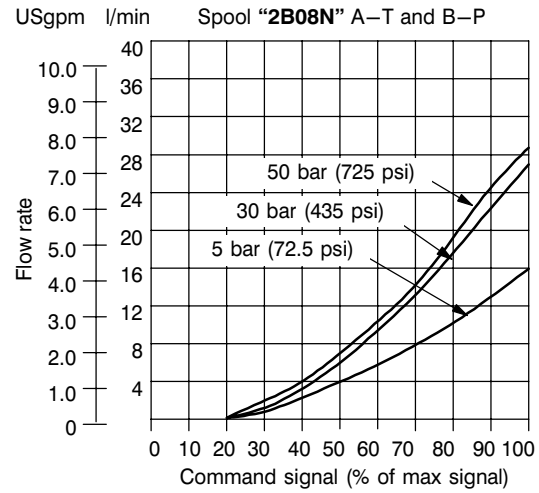

KDG4V-3S and KTG4V-3S Power Capacity Envelopes

KDG4V-3S

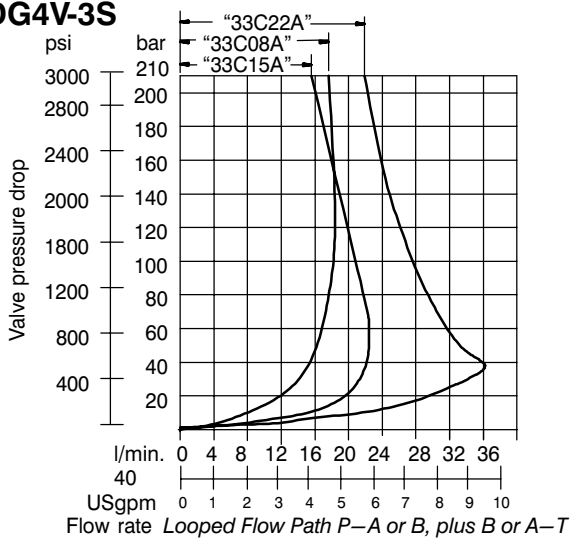

KTG4V-3S

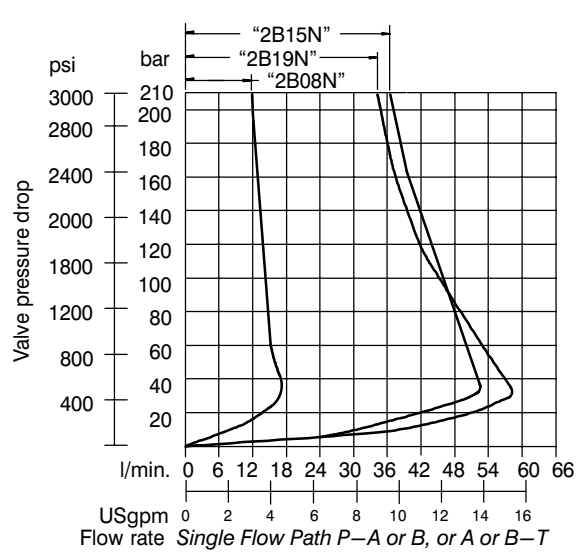
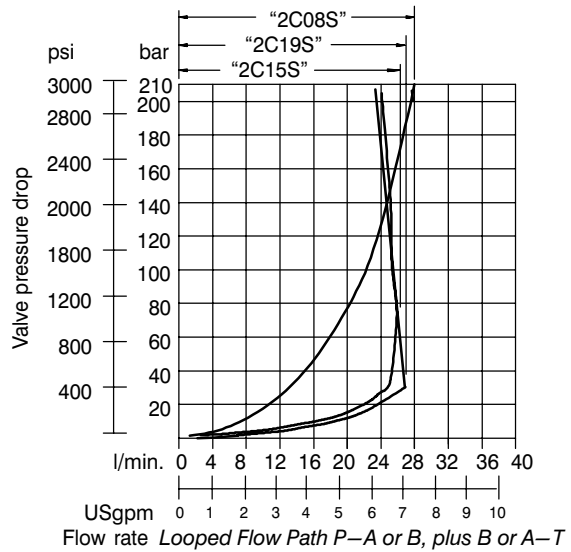
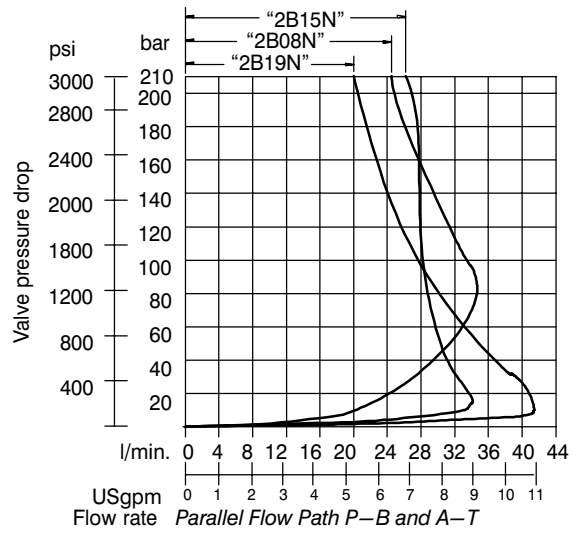
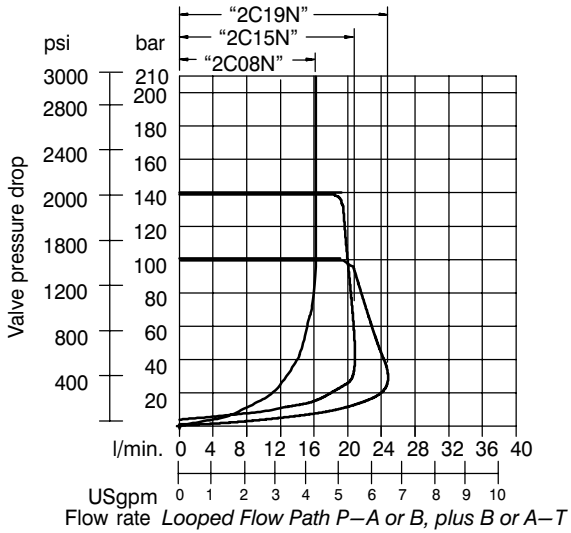
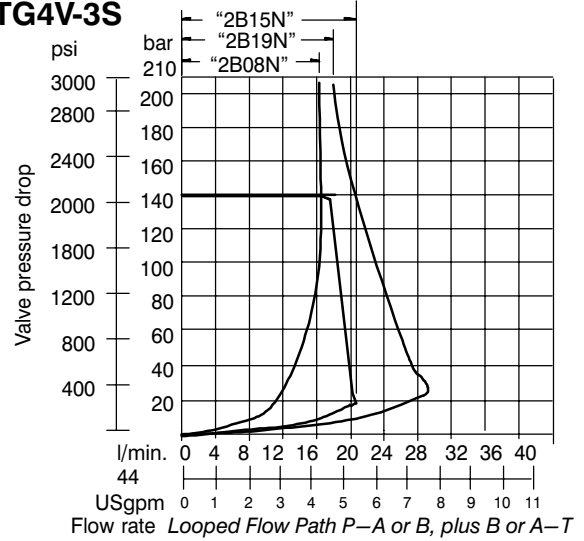

KDG4V-3S and KTG4V-3S Frequency Response

For amplitude of 25% maximum stroke
(center to offset) about 50% position and
 $\Delta p(P \rightarrow A \rightarrow B \rightarrow T) = 10 \text{ bar (145 psi)}$

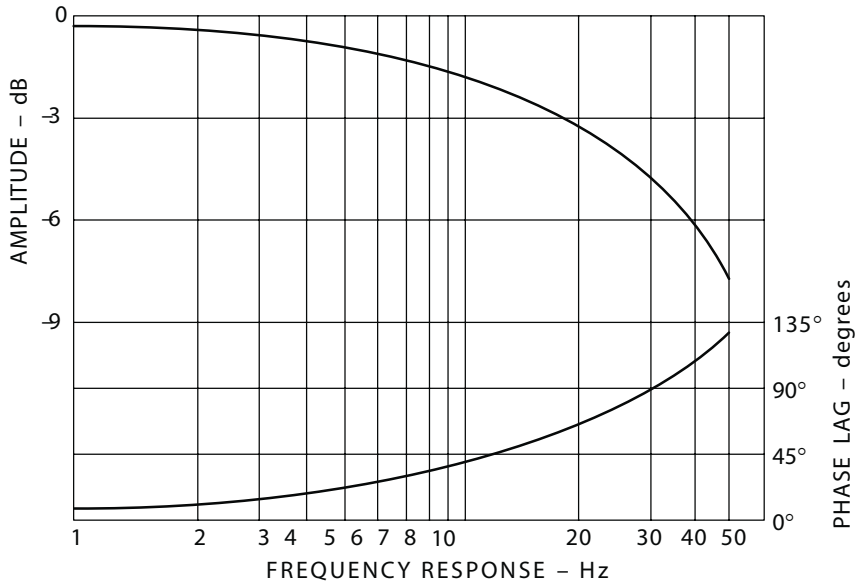

KDG4V-3S and KTG4V-3S Installation Dimensions

KDG4V-3S and KTG4V-3S with Junction Box

Dimensions in mm (inches)

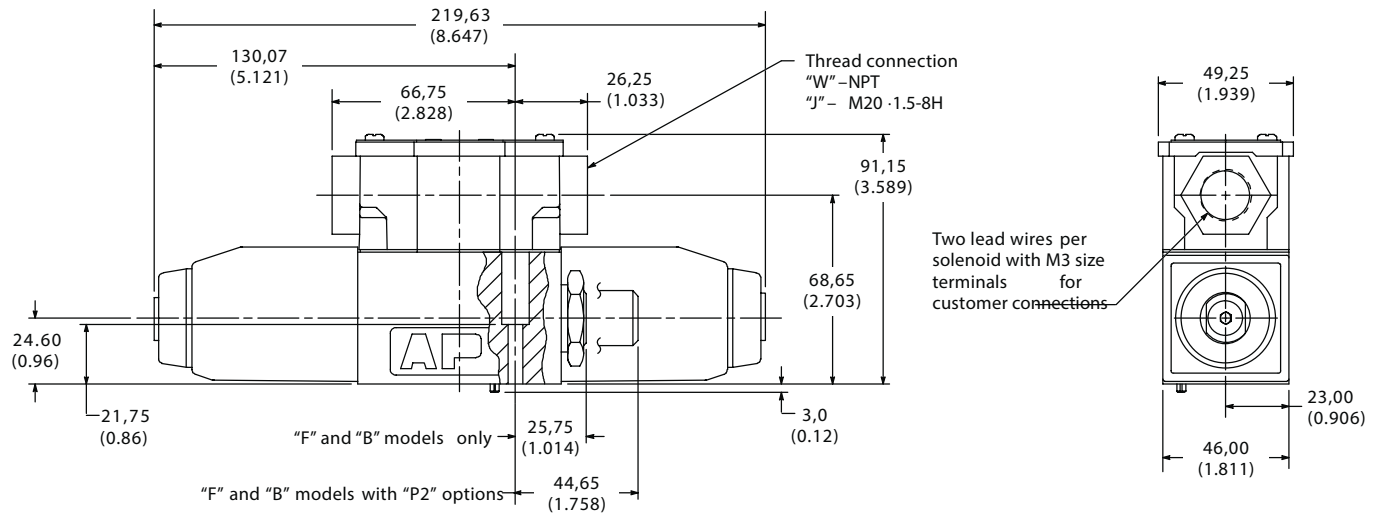

Water-resistant Manual Override on Solenoid

K*G4V-3S-(L)-H-(V)M-**-**-60**

Dimensions in mm (inches)

Use where finger operation is required.
(Standard manual overrides cannot be operated without using small tool.)

This "H" feature is not field-convertible from other models. Please specify with order.

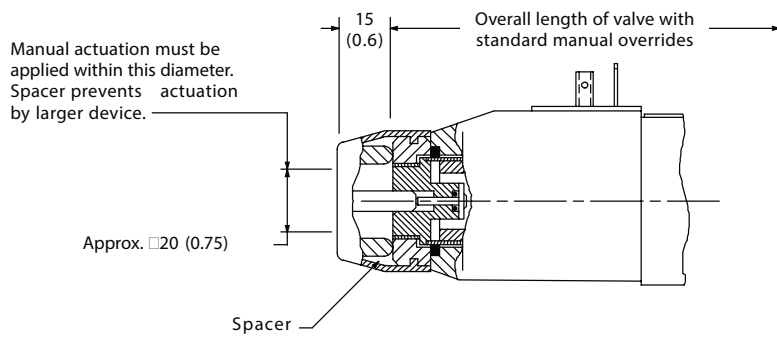

KDG4V-3S (shown) and KTG4V-3S with DIN Connectors

Dimensions in mm (inches).

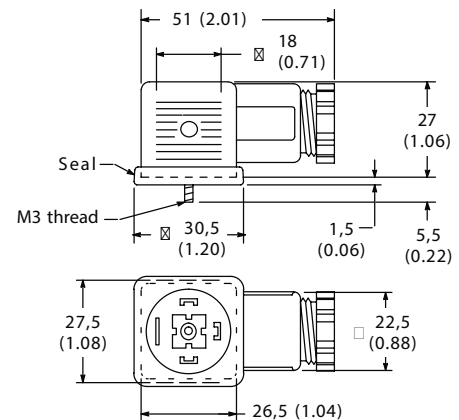
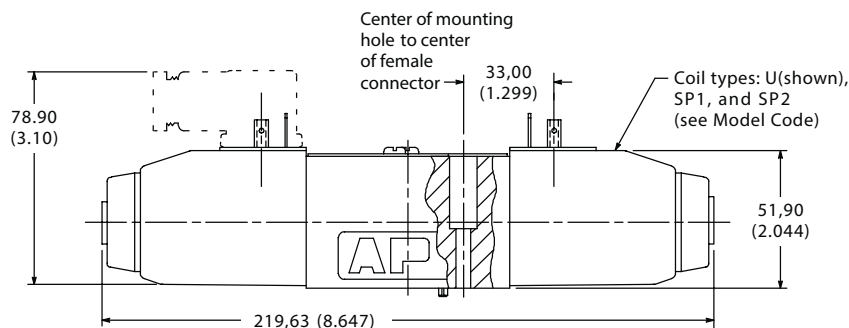

Plug connector can be positioned in 90° increments on valve by removing connector housing and re-assembling contact holder at desired orientation inside housing.

DIN 43650 plug connector can be ordered separately or included with valve by specifying 1 for Model Code item 19.

Means of connection: screw terminals

Conductor cross-sectional area:
0,5 to 1,5 mm² (0.0008 to 0.0023 in²)

Cable diameter:
6 to 10 mm (0.24 to 0.40 in)

KTG4V-3S with EN427 Feature

KTG4V-3S-2B 08N-(V)M-*** ***(1)-H5-60-EN427

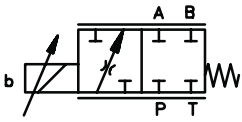

This valve feature is recommended for use as a pilot valve with the Valvistor Slip-in Cartridge Valve.

The spool adjuster is preset at the factory. Do not adjust. Improper operation will result.

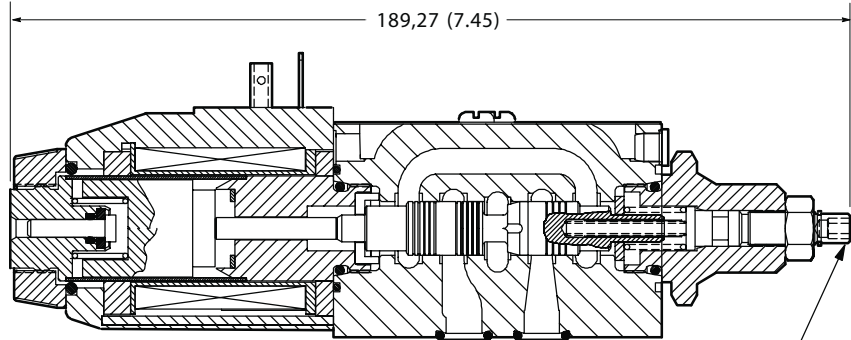

Spool adjuster (Factory set. Do not adjust)

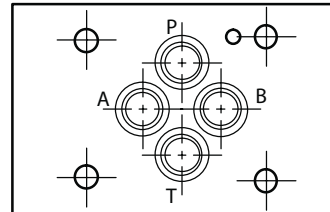

EN427 Performance

Flow Gain Curve

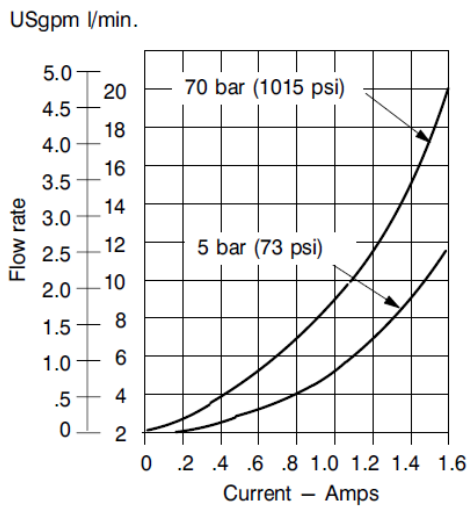

Power Capacity Curve

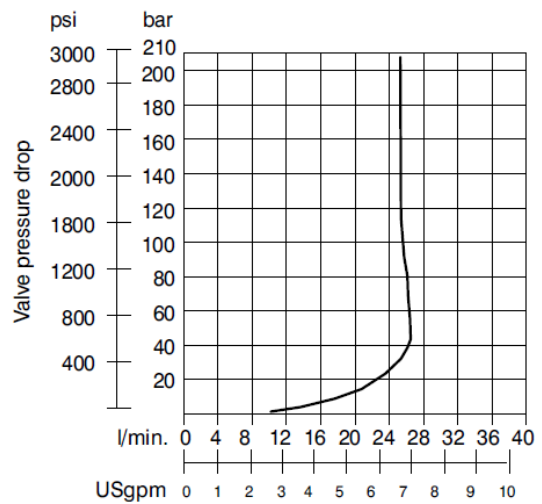

KDG4V-3S and KTG4V-3S Electrical Connections

Terminal Strip for FT (Flying Lead) Models

Dimensions in mm (inches)

* Difference in dimensions helps ensure correct orientation of nameplate to valve.

** For DC coils, positive + lead(s) must be connected to terminal(s) marked +. When using 3-wire incoming leads to double solenoid valves (i.e. common neutral), inner pair of terminals must be interconnected.

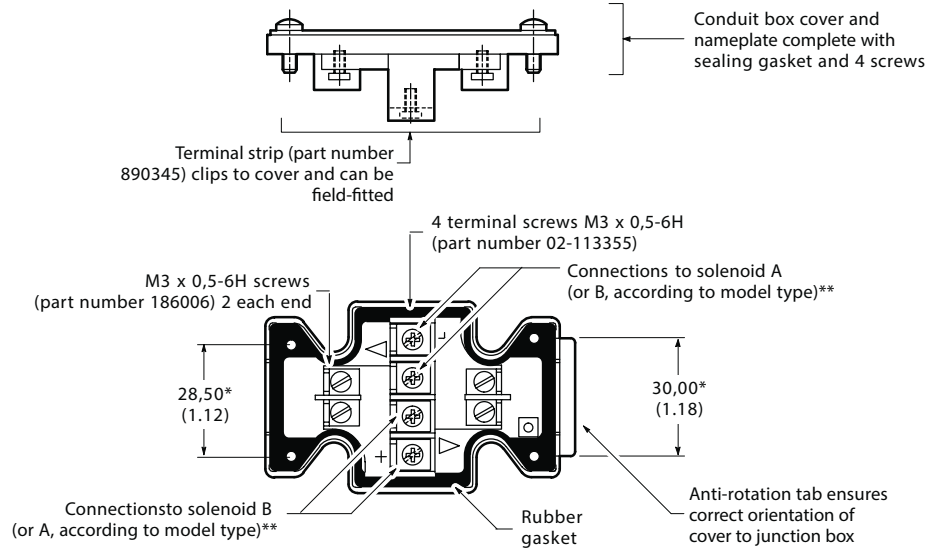

NFPA Connector (Standard T.3.5.29-1980) for FPA3 and FPA5 Models

Dimensions in mm (inches)

The receptacle is a standard three-pole or five-pole electrical connector with shortened leads and terminals added. The five-pole plug has four leads 101,6 (4.0) long and one lead 177,8 (7.0) long. All wires have non-solder insulated eyelet terminals. The green wire is used for the ground connection (No. 8 screw furnished). Valves are supplied pre-wired.

WARNING

Electrical power must be disconnected before removing or replacing this receptacle.

Electrical connection is over solenoid A on single solenoid models and over solenoid B on dual solenoid models. See diagram plate for solenoid B location.

Receptacle is pre-wired to solenoid eyelets. Connection is made with No. 6 screws and nuts insulated with black electrical tape.

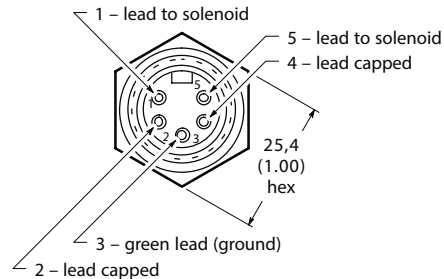
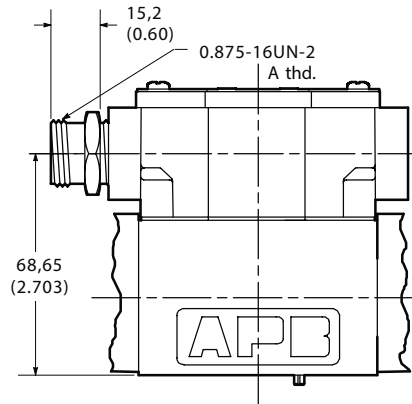

KTG4V-3S--M-FPA5**

B models
F models

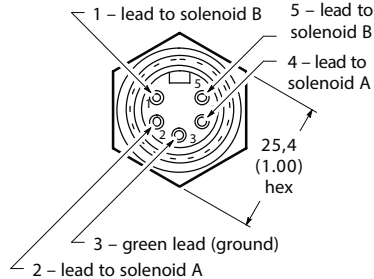

KDG4V-3S-*C-M-FPA5

C models

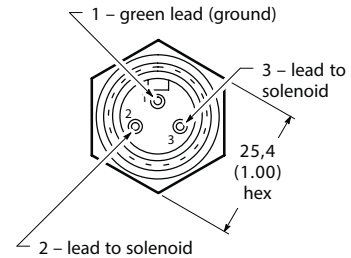

KTG4V-3S--M-FPA3**

B models
F models

Model Code –K(A)*G4V-3 High Performance Valves

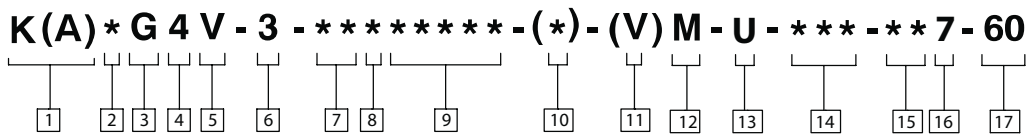

1 Valve type

K – Proportional
KA– Proportional with integral amplifier

2 Valve function

D – Directional valve (Double solenoid, C models. See item 8.)
T – Throttle valve (Single solenoid, B models. See item 8.)

3 Mounting

G – Subplate/manifold mounted

4 Operation

4 – Solenoid operated

5 Pressure rating

V – 350 bar (5075 psi) on P, A, and B ports

6 Interface

3 – ISO 4401-03, CETOP 3 (NFPA D03)

7 Spool type (center condition)

2 – Closed center (all ports)
33 – P port closed, bleed A and B to T

8 Spool/spring arrangement

B – Spring centered, solenoid A removed – KTG4V-3
C – Spring centered, dual solenoid – KDG4V-3

9 Spool flow rating

For looped flow path P→A→B→T or P→B→A→T: $\Delta p = 10$ bar (145 psi).

For single flow path P→A or B→T:
 $\Delta p = 5$ bar (72 psi).

Symmetric Spools

03F – 3 l/min (0.8 USgpm)
07N – 7 l/min (1.8 USgpm)
13N – 13 l/min (3.4 USgpm)
20N – 20 l/min (5.3 USgpm)
28S – 28 l/min (7.4 USgpm) – available with type 2 spool only

Asymmetric Spool – KDG4V Only

First figure (20N) is flow rating P→A or A→T; last figure (N10) is flow rating P→B or B→T.

20N10 – 20 l/min (5.3 USgpm) “A” port flow, and 10 l/min (2.65 USgpm) “B” port flow

10 Manual override(s)

H – Water-resistant
Z – No override(s)
Blank – Plain override(s)

11 Solenoid energization identity

V – Solenoid identification determined by position of solenoid (solenoid A on A port end, solenoid B on B port end)
Blank – Standard per ANSI B93.9 (energize solenoid A, flow is (P→A))

12 Flag symbol

M – Electrical options and features

13 Coil type

U – DIN 43650 connector. Order solenoid plug separately; see page 30.
F – Flying lead solenoids (KA type valves only)

14 Electrical connection (KA valves only)

PD7 – 7-pin connector with plastic plug. See warning note below.

15 Coil voltage rating

G – 12V DC
H – 24V DC¹
GP – Direct 12V DC or EM-VP/VT amplifier
HA – Direct 24V DC or EM-VP/VT amplifier
¹KA type valves must have H type coils.

16 Tank pressure rating

7 – 210 bar (3000 psi)

17 Design number

Subject to change.



Warning: To conform to the EC Electromagnetic Compatibility directive (EMC), this KADG4V or KATG4V valve must be fitted with a metal 7-pin plug. The screen of the cable must be securely connected to the shell of the metal connector. A suitable IP67 rated connector is available from Danfoss, part no. 934939. Alternatively, a non IP67 rated connector is available from ITT-Cannon, part no. CA 02 COM-E 14S A7 P.

Additionally, the cable must be fitted with a ferrite EMC suppression core not more than 4cm from the connector referred to above. Suitable types include Farnell 535-898 or Farnell 535-904 which snap-fit over the cable. The plastic plug, part no. 694534, is only suitable for use in a sealed electromagnetic environment or outside of the European Community

K(A)DG4V-3 and K(A)TG4V-3 Application Data

Specifications

Maximum operating pressure (A, B and P ports)

350 bar (5000 psi)
(See "Flow Gain Curves")

Maximum tank line pressure (T port)

210 bar (3000 psi)

Maximum recommended pressure drop (four-way models at max. flow)

210 bar (3000 psi)*

*At pressure drops above 10 bar (145 psid) dither amplitudes in the electronic controller may need to be set at or near minimum to eliminate potential high frequency circuit noise.

Minimum recommended flow rates for K(A)DG4V-3

Spool Code	l/min	in ³ /min
**C03F	0,2	12
**C07F	0,4	24
**C13F	0,6	36
**C20F	1,0	60
**C28S	1,4	85

Mounting pattern

ISO-4401-AB-03-4-A, NFPA D03, CETOP 3

Operating temp . . . 20 to 82C
(-4 to 180F)

Fluid viscosity . . . 16 – 54 cSt
(75–250 SUS)

Weights (approximate)

KDG4V-3-* -60 . . .2,4 kg (5.30 lbs.)
KTG4V-3-* -60 . . .1,7 kg (3.75 lbs.)
KADG4V-3-* -60 . . .2,8 kg (6.20 lbs.)
KATG4V-3-* -60 . . .2,1 kg (4.65 lbs.)

Performance

Frequency Response

See graph on page 14.

Hysteresis

At $\Delta p = 5$ bar (72 psi) < 8% at rated flow

Reproducibility, valve-to-valve

Optimized by adjustment of deadband compensation, gain and ramp potentiometers on associated Vickers amplifier.

Solenoid Specifications

Maximum current @ 50C (122F) ambient

G	3.5A
H	1.6A
GP	3.0A
HA	0.94A

Coil Resistance @ 20C (68F)

G	1.55 Ohms
H	7.3 Ohms
GP	2.0 Ohms
HA	22.1 Ohms

Coil Inductance @ 1000 Hz

G	4 mH
H	20 mH
GP	6 mH
HA	55 mH

Relative duty factor

Continuous rating ED = 100%

Type of protection, with electrical plugs fitted correctly

IEC 144 Class IP65

Step Input Response

At $\Delta p = 5$ bar (72 psi) per metering path.

Required step: Time to reach 90% of req'd step:

0 to 100%	25 ms
100% to 0	30 ms
+90 to -90%	35 ms

Amplifiers

Coil Voltage Identification Letter	Amplifier
H	EEA-PAM -523-A-30
	EEA-PAM -523-B-30
	EEA-PAM -523-C-30
	EEA-PAM -523-D-30
	EEA-PAM -523-E-30
GP	EM-VT-12-10 ☒
	EM-VP-12-10 ☒
HA	EM-VT-24-10 ☒
	EM-VP-24-10 ☒
Plug Amplifier	
G	EHH-AMP-712-D/G-20
H	EHH-AMP-702-C-10
	EHH-AMP-702-D-10
	EHH-AMP-702-E-10
	EHH-AMP-702-F-10

☒ Refer to drawing I-521575 for information.

Drain

On 2-way valves, "T" is the drain and must be connected to the tank through a surge-free line, so there will be no back pressure at this port.

KADG4V-3 and KATG4V-3 Application Data

KAD/TG4V-3 Valves with Integral Amplifiers

Power supply	24V DC (21V to 36V including 10% peak-to-peak max. ripple) max. current 3A
Command signal Input impedance	0 to +10V DC, or 0 to -10V DC, or -10V to +10V DC 47 k Ω
7-pin plug connector Pin connections: A B C D E F G	Power supply +ve Power 0V Signal 0V +ve voltage command signal -ve voltage command signal Monitor output Protective ground
Electro-magnetic compatibility (EMC): Emission (10 v/m) Immunity (10 v/m) See notes regarding EMC, below and on pages 18 and 29.	EN 50081-2 EN 50082-2
Gain adjustment	25 to 125%
Factory set adjustments	Deadband, gain, dither and offset
Monitor point signal Output impedance	0,5V per amp solenoid current 10 k Ω
Power stage PWM frequency	2 kHz nominal
Repeatability, valve-to-valve (at factory settings): Flow gain at 100% command signal	5%
Protection: Electrical Mechanical	Reverse polarity protected IEC 144, Class IP65
Relative humidity	65 to 85% at 20 to 70C (68 to 158F)

Supporting products:

Auxiliary electronic modules (DIN-rail mounting):

EHA-CON-201-A-2* signal converter EHD-

DSG-201-A-1* command signal generator EHA-

RMP-201-A-2* ramp generator EHA-PID-201-A-2* PID controller

Subplates, size 03 Mounting bolts

Note: If not using Vickers recommended bolt kits, bolts must be to ISO 898 grade 12.9 or stronger.



This product has been designed and tested to meet specific standards outlined in the European Electromagnetic Compatibility Directive (EMC) 89/336/EEC, amended by 91/263/EEC, 92/31/EEC and 93/68/EEC, article 5. For instructions on installation requirements to achieve effective protection levels, see this leaflet, the Installation Wiring Practices for Vickers Electronic Products leaflet 2468, and leaflet 02-123931A which is packed with every KA valve. Wiring practices relevant to this Directive are indicated by Electromagnetic Compatibility (EMC).

K(A)DG4V-3 and K(A)TG4V-3 Flow Paths

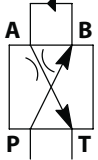
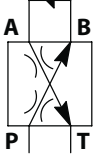
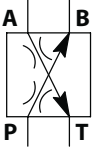
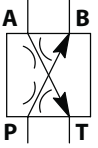
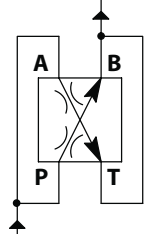
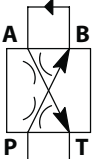
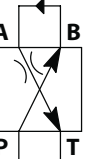
Valve/Flow Path	Spool	Symbol
K(A)DG4V-3 with Looped Flow Path. P→A or B, plus B or A→T	**C28S	
	**C03F **C07N **C13N **C20N	
K(A)DG4V-3 with Single Flow Path. P→A or B, or A or B→T	**C03F **C07N **C13N **C20N	
K(A)TG4V-3 with Single Flow Path. P→A or B, or A or B→T	**B03F **B07N **B13N **B20N	
K(A)TG4V-3 with Parallel Flow Path. P→B and A→T	**B13N **B20N	
K(A)TG4V-3 with Looped Flow Path. P→A or B, plus B or A→T	**B03N **B07N **B13N	
K(A)TG4V-3 with Looped Flow Path. P→A or B, plus B or A→T	**B28S	

K(A)DG4V-3 Flow Gain Curves

At the stated valve pressure drops, the percentage command signals are applicable to whichever solenoid is energized.

Looped Flow Path

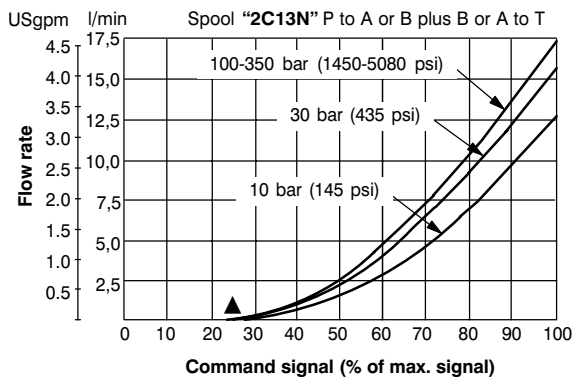
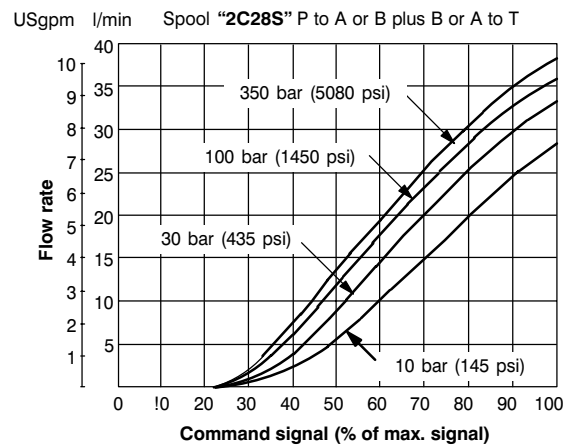
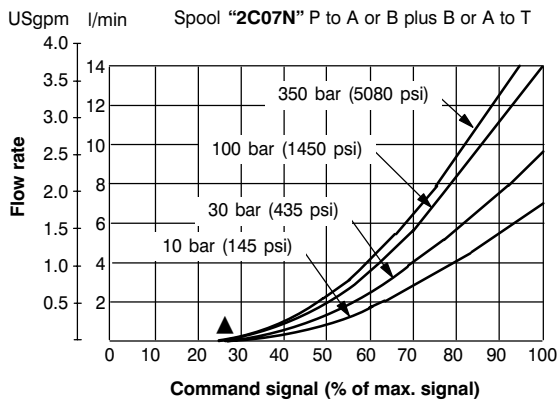
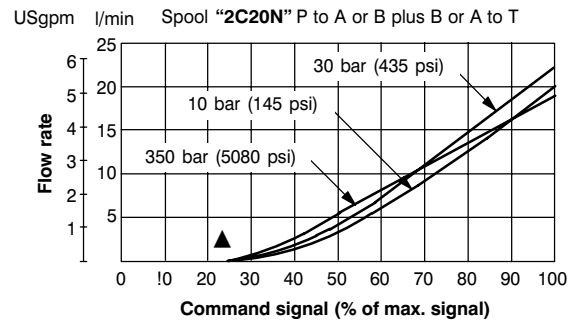
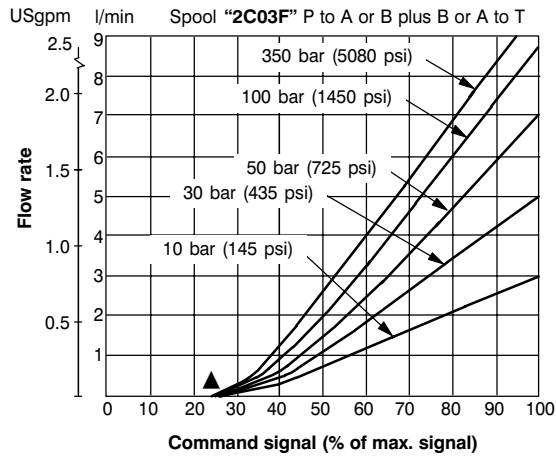

▲Curves shown are for spool types "2". These points will vary from valve to valve, but can be adjusted using the deadband-compensation feature of the drive amplifier. For spool types "33", the curves are similar, but flow starts at slightly higher command signals.

At the stated valve pressure drops, the percentage command signals are applicable to whichever solenoid is energized.

Single Flow Path

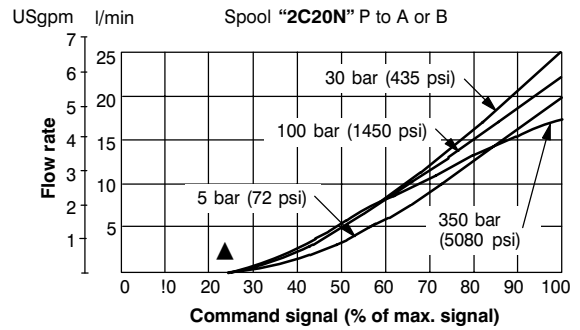
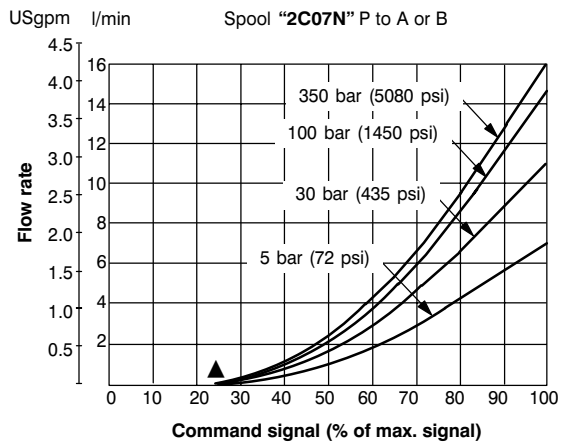
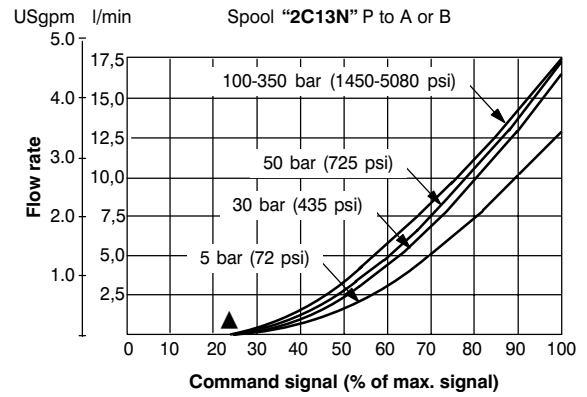
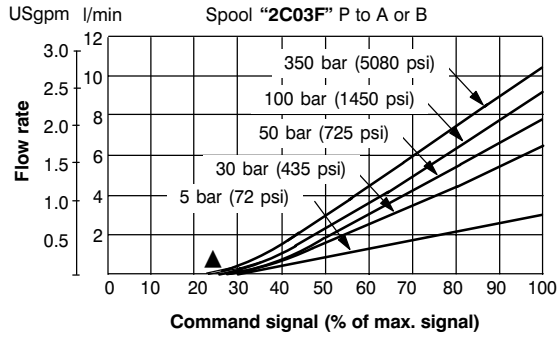

▲Curves shown are for spool types "2". These points will vary from valve to valve, but can be adjusted using the deadband-compensation feature of the drive amplifier. For spool types "33", the curves are similar, but flow starts at slightly higher command signals.

K(A)TG4V-3 Flow Gain Curves

At the stated valve pressure drops, the percentage command signals are applicable to whichever solenoid is energized.

Single Flow Path

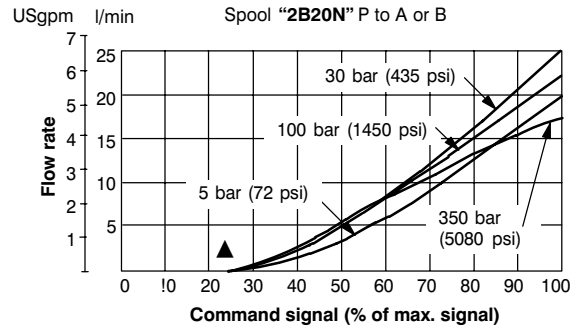
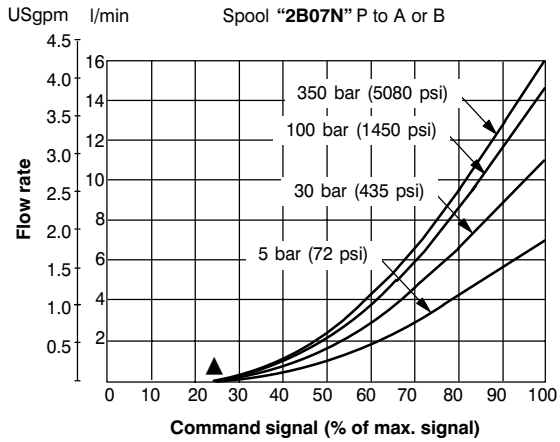
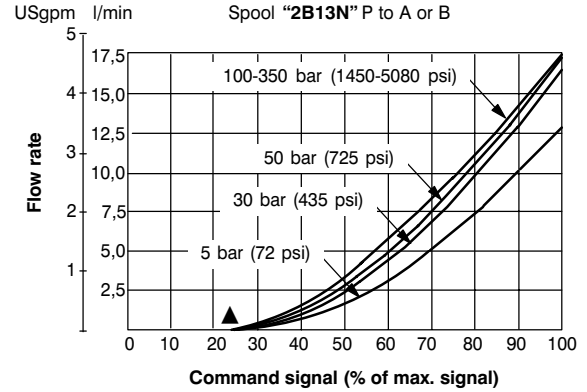
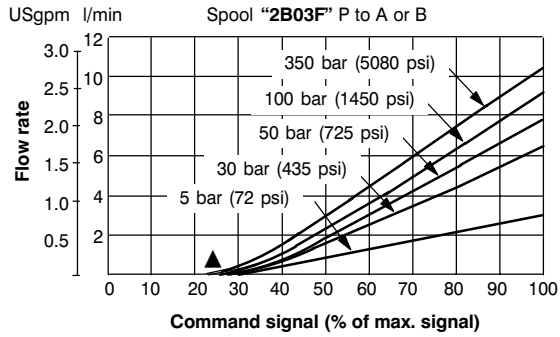

▲Curves shown are for spool types "2". These points will vary from valve to valve, but can be adjusted using the deadband-compensation feature of the drive amplifier. For spool types "33", the curves are similar, but flow starts at slightly higher command signals.

At the stated valve pressure drops, the percentage command signals are applicable to whichever solenoid is energized.

Parallel Flow Path

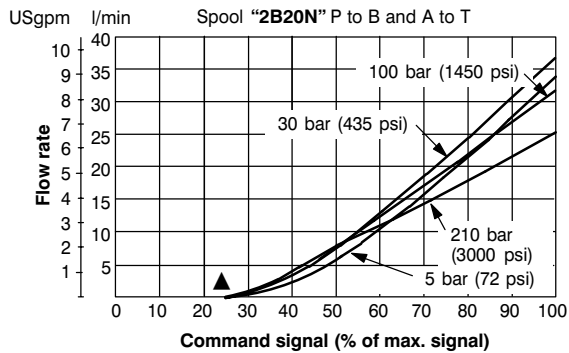
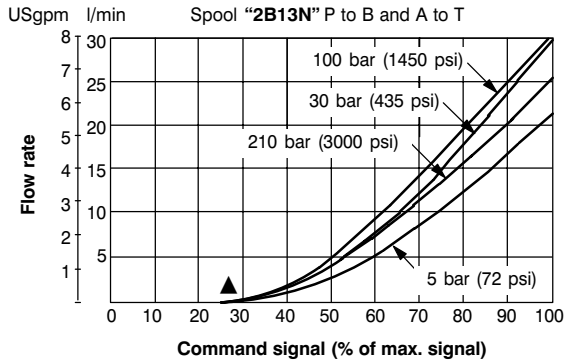

▲Curves shown are for spool types "2". These points will vary from valve to valve, but can be adjusted using the deadband-compensation feature of the drive amplifier. For spool types "33", the curves are similar, but flow starts at slightly higher command signals.

Power Capacity Envelopes

K(A)DG4V-3 and K(A)TG4V-3 Looped Flow Path

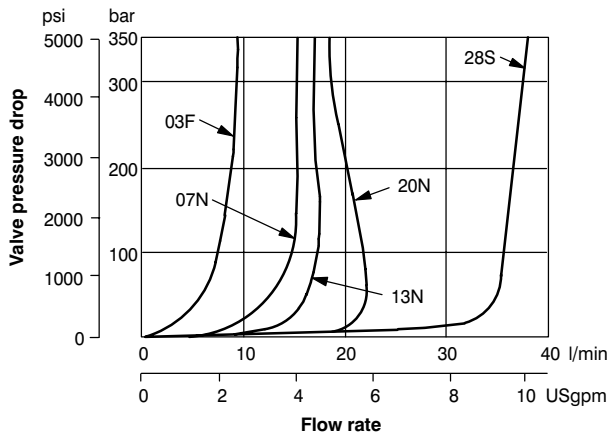

K(A)TG4V-3 Single Flow Path

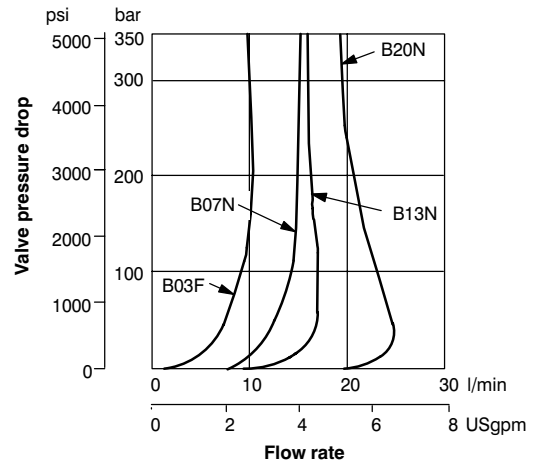

K(A)DG4V-3 Single Flow Path

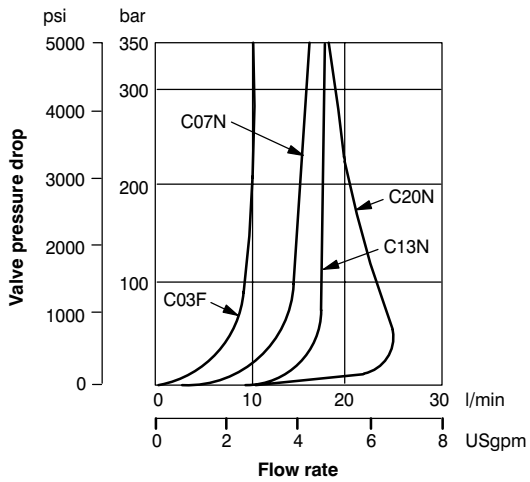

K(A)TG4V-3 Parallel Flow Path

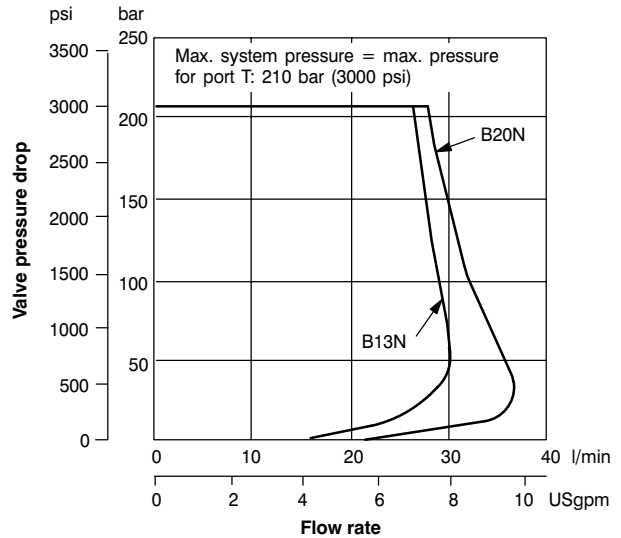

K(A)DG4V-3 and K(A)TG4V-3 Frequency Response

For amplitude of 25% maximum stroke about the 50% position, at $\Delta p (P \rightarrow B) = 5 \text{ bar (72 psi)}$.

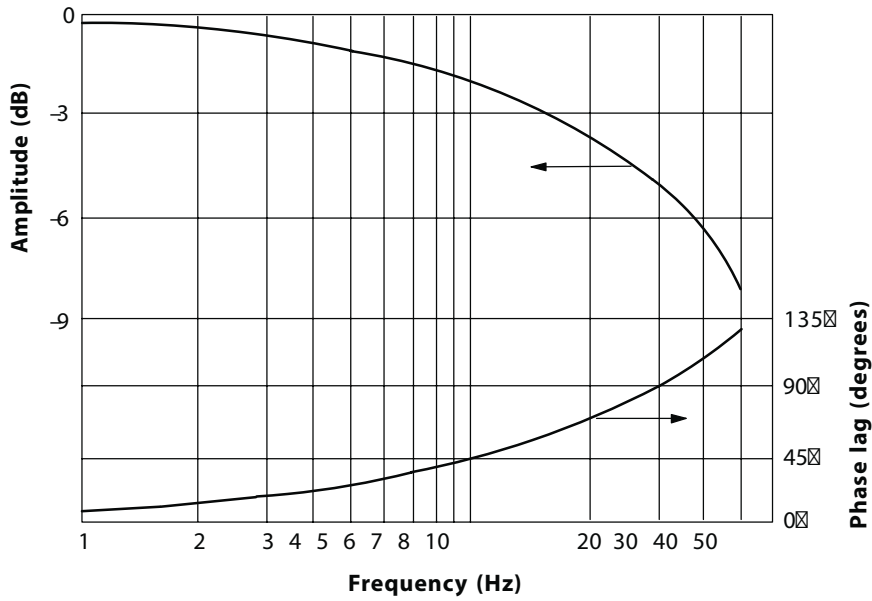

KADG4V-3 & KATG4V-3 Electrical Block Diagram

Command Signals and Outputs

7-pin plug		Flow direction
Pin D	Pin E	
Positive	0V	P to A
0V	Negative	
U _D -U _E = Positive		P to A
Negative	0V	
0V	Positive	P to A
U _D -U _E = Negative		

Wiring

Connections must be made via the 7-pin plug mounted on the amplifier.
Recommended cable sizes are:

Power cables:

For 24V supply

0,75 mm² (18 AWG) up to 20m (65 ft)

1,00 mm² (17 AWG) up to 40m (130 ft)

Signal cables:

0,50 mm² (20 AWG)

Screen:

A suitable cable would have 7 cores, a separate screen for the signal wires, and an overall screen. See wiring connection diagram on page 29.

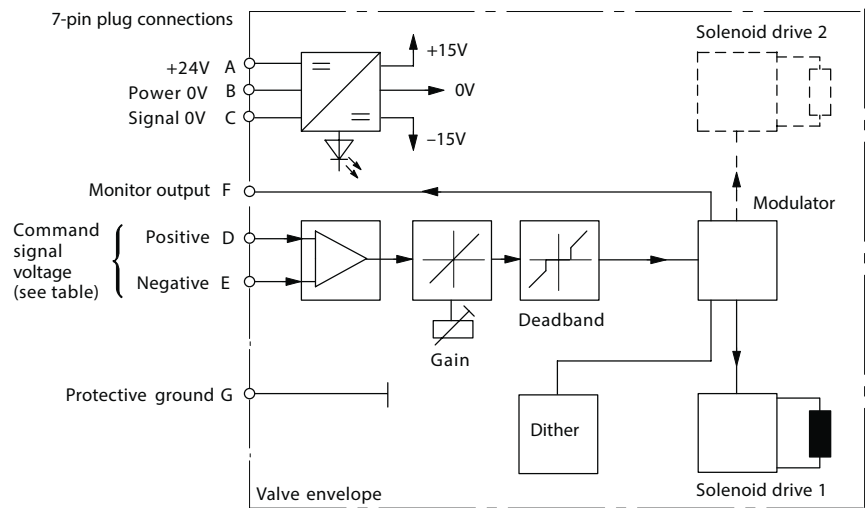

Warning

All power must be switched off before connecting or disconnecting any plugs.

KADG4V-3 & KATG4V-3 Typical Connection Arrangements

Wiring Connections for Valves with integral Amplifier

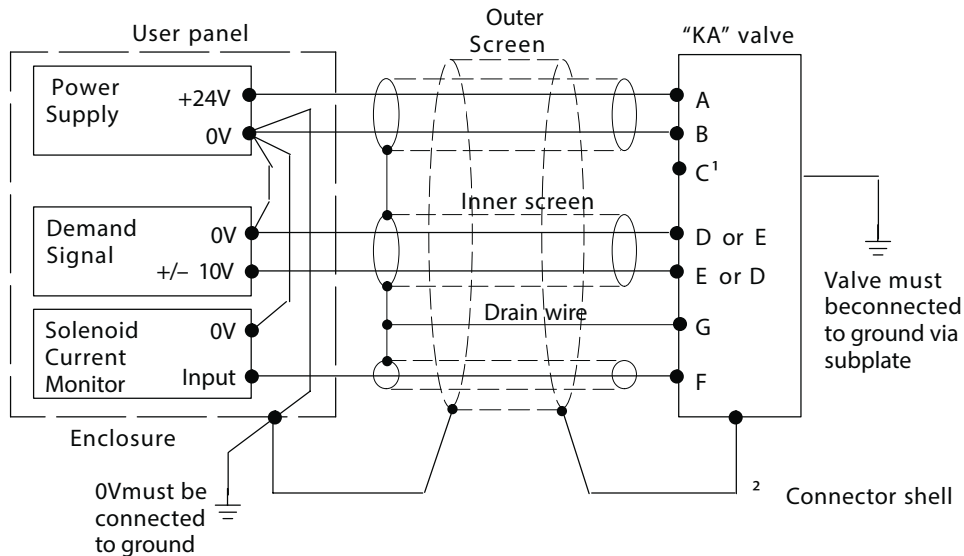

¹Solenoid current monitor voltage (pin F) will be referenced to the KA valve local ground. A "local ground" (pin C) is provided for optional use by differential input customer supplied electronics.

²Note: In applications where the valve must conform to European RFI/EMC regulations, the outer screen (shield) must be connected to the outer shell of the 7-pin connector and the valve body must be fastened to the earth ground. Proper earth grounding practices must be observed in this case, as any differences in command source and valve ground potentials will result in a screen (shield) ground loop.



Warning

Do not ground pin C. If the local ground (pin C) is not used for differential monitor electronics, do not use. Read monitor pin F with respect to ground.



Warning

Electromagnetic Compatibility (EMC)

It is necessary to ensure that the valve is wired-up as above. For effective protection, the user electrical cabinet, the valve subplate or manifold, and the cable screens should be connected to efficient ground points. The metal 7-point connector, part no. 934939, should be used for the integral amplifier.

In all cases, both valve and cable should be kept as far as possible from any sources of electromagnetic radiation such as cables carrying heavy current, relays and certain kinds of portable radio transmitters, etc. Difficult environments could mean that extra screening may be necessary to avoid the interference.

It is important to connect the 0V lines as shown above. The multi-core cable should have at least two screens to separate the demand signal and monitor output from the power lines.

KDG4V-3 and KTG4V-3 Installation Dimensions

KDG4V-3

Dimensions in mm (inches)

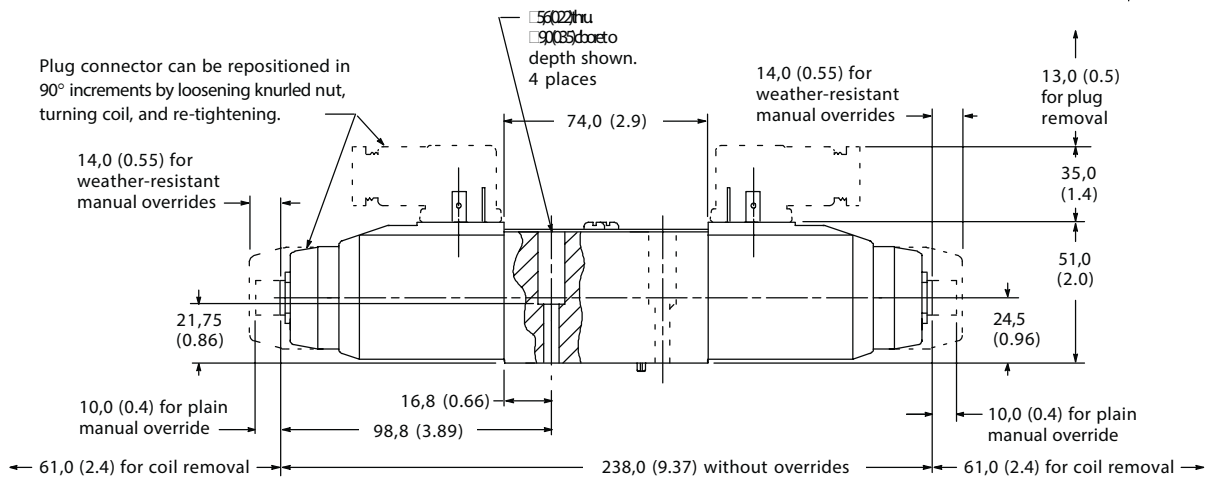

KTG4V-3

Dimensions in mm (inches)

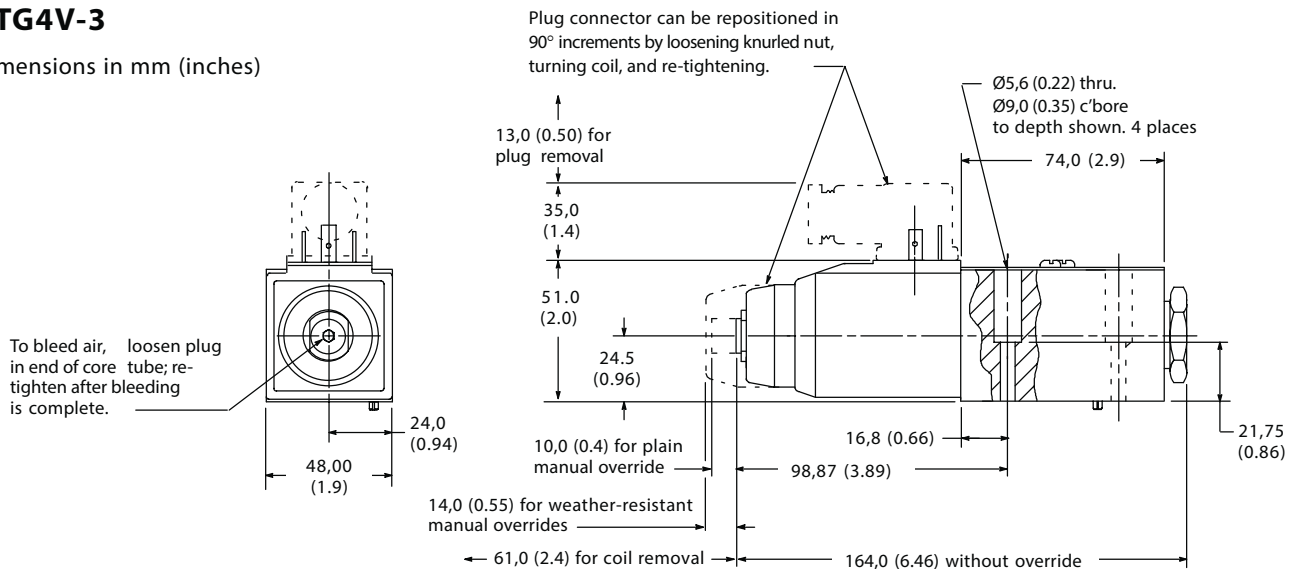

Solenoid Plug Connectors

Dimensions in mm (inches)

DIN 43650 plug connector is not included with valve and must be ordered separately. For black plug marked B, order part 710775. For gray plug marked A, order part 710776.

Conductor cross-sectional area:
0,5 to 1,5 mm² (0.0008 to 0.0023 in²)

Cable diameter range:
6 to 10 mm (0.24 to 0.40 in)

Means of connection: screw terminals

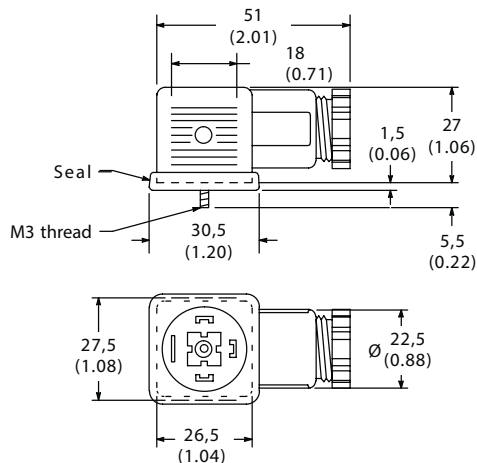

KADG4V-3 and KATG4V-3 Installation Dimensions

KADG4V-3

Dimensions in mm (inches)



Metal plug 934939

Cable outside diameter 8,0 to 10,5 (0.31 to 0.41)
Must be used for full EMC protection. See also
warning note on page 18.

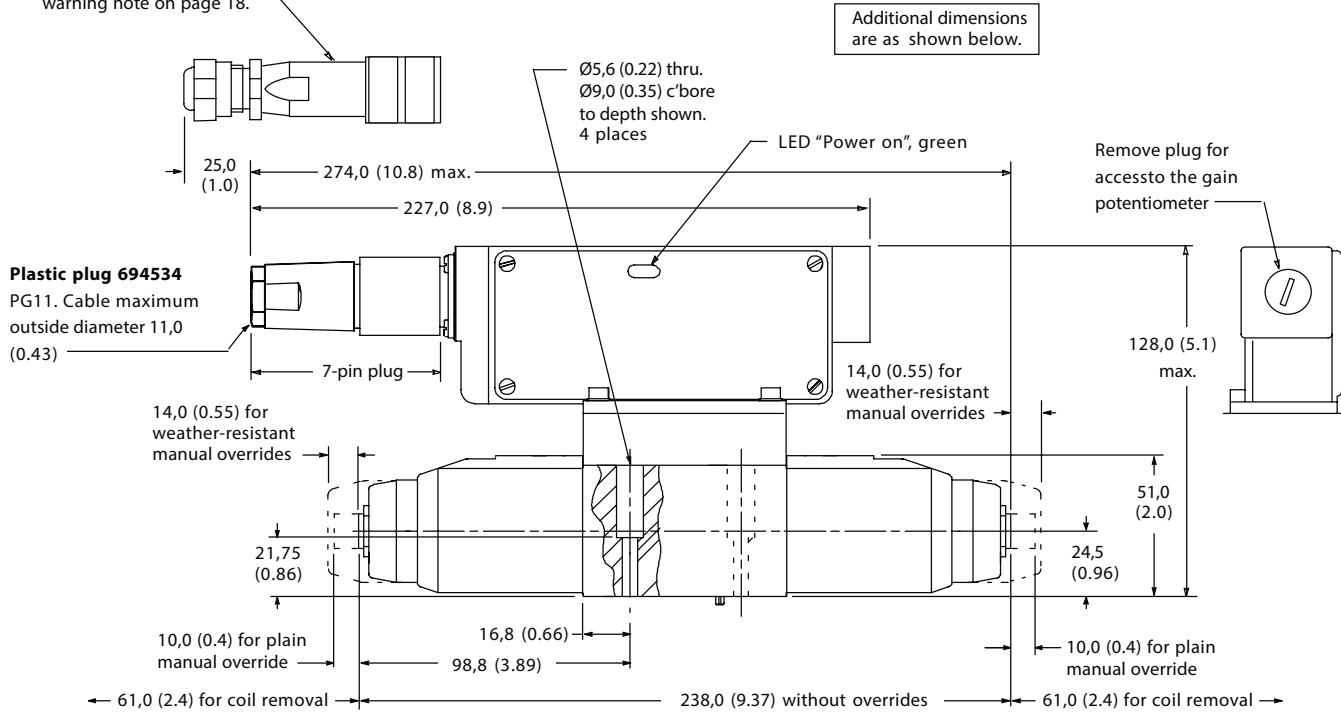

KATG4V-3

Dimensions in mm (inches)

7-pin plugs for integral amplifiers

Metal 934939
Plastic 694534 (Metal
plug must be used
for full EMC protection.)

Do not remove
these plugs.

To bleed air, loosen plug
in end of core tube; re-
tighten after bleeding
is complete.

PG 11 cable gland. Max.
cable diameter 11,0 (0.43),
on 7-pin plug supplied with
valve. Replacement part
numbers shown at left.

Additional dimensions
are as shown above.

Remove plug for
access to the gain
potentiometer

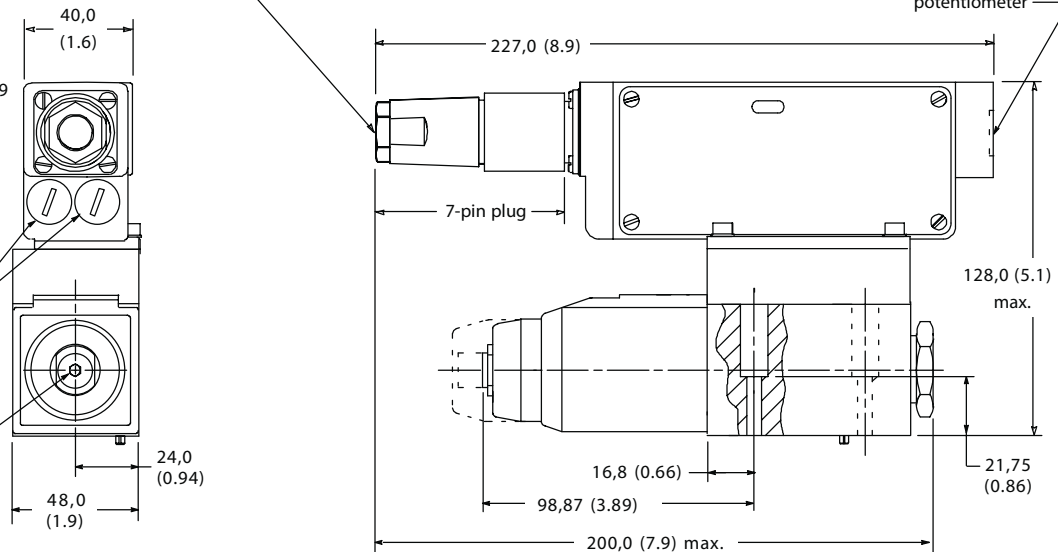

Mounting Requirements

Mounting Surface

Mounting surface must be flat within 0,013 mm (0.0005 inch) and smooth within 1,1 micrometer (45 microinch). Mounting bolts should be grade 12.9 (SAE grade 7) or better.

* Minimum thread depth is $1\frac{1}{2} \cdot$ bolt diameter (D). Recommended full thread depth is $2 \cdot D + 6$ mm. This aids in interchangeability of valves and reduces number of fixing bolt lengths. Recommended engagement of fixing bolt thread for ferrous mountings is $1\frac{1}{4} \cdot D$.

** Dimensions specifying area within dotted lines are minimum dimensions for mounting surface. Corners of rectangle may be radiused as shown.

***Dimension is minimum spacing distance between valve and adjacent obstructions such as wall or other valve. Dimension is also minimum distance from centerline to centerline of two similar mounting surfaces placed on manifold block. Fixing holes are at equal distances to dimension.

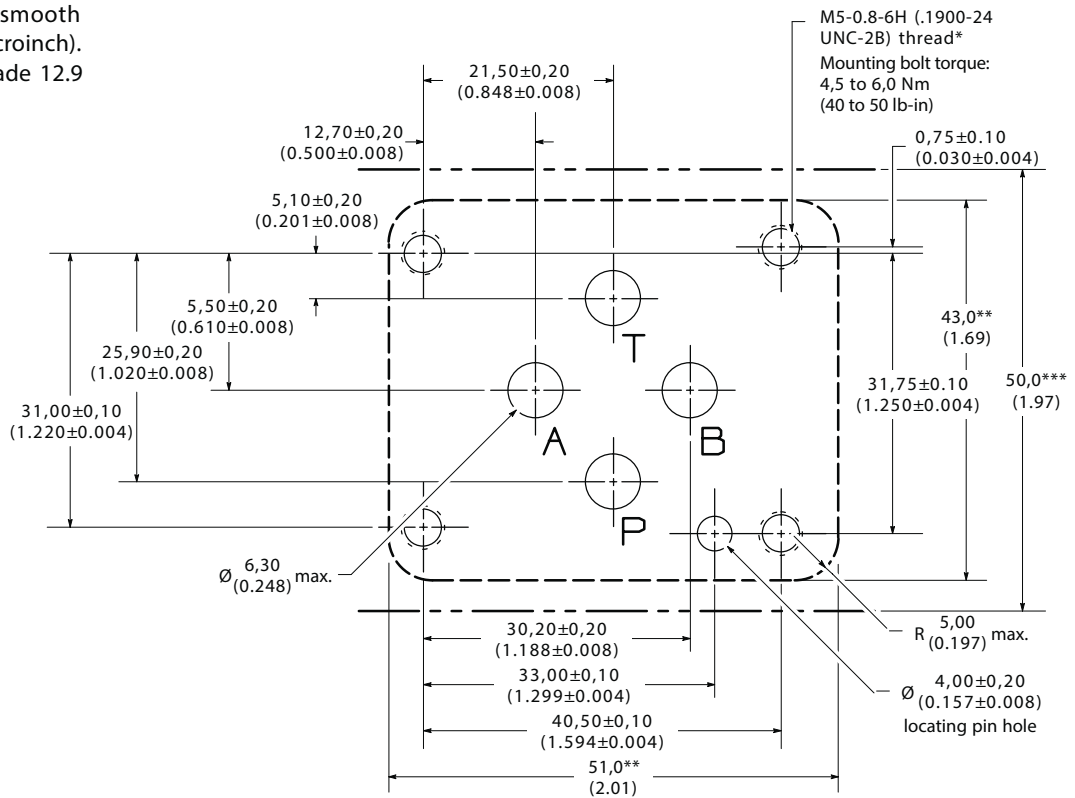

Subplate and Bolt Kits

Valve subplates and mounting bolts are available and must be ordered separately.

Example:

- (1) KDG4V-3S-2C08S-M-FW-G5-60 valve
- (1) KDG4V-3S-2C08S-MU1-H5-60 valve
- (1) DGVM-3-10-S subplate
- (1) BK590716 inch mounting bolt kit
- (1) BK616452M metric mounting bolt kit

Fluid Cleanliness

Proper fluid condition is essential for long and satisfactory life of hydraulic components and systems. Hydraulic fluid must have the correct balance of cleanliness, materials, and additives for protection against wear of components, elevated viscosity and inclusion of air.

Recommended cleanliness levels, using petroleum oil under common conditions, are based on the highest fluid pressure levels in the system and are coded in the chart below. Fluids other than petroleum, severe service cycles, or temperature extremes are cause for adjustment of these cleanliness codes.

Vickers by Danfoss products, as any components, will operate with apparent satisfaction in fluids with higher cleanliness codes than those described. Other manufacturers will often recommend levels above those specified. Experience has shown, however, that life of any hydraulic component is shortened in fluids with higher cleanliness codes than those listed below. These codes have been proven to provide a long, trouble-free service life for the products shown, regardless of the manufacturer.

Product	System Pressure Level bar (psi)		
	<138 (<2000)	138–207 (2000–3000)	207+ (3000+)
Vane pumps, fixed	20/18/15	19/17/14	18/16/13
Vane pumps, variable	18/16/14	17/15/13	
Piston pumps, fixed	19/17/15	18/16/14	17/15/13
Piston pumps, variable	18/16/14	17/15/13	16/14/12
Directional valves	20/18/15	20/18/15	19/17/14
Proportional valves	18/16/13	18/16/13	17/15/12
Servo valves	16/14/11	16/14/11	15/13/10
Pressure/Flow controls	19/17/14	19/17/14	19/17/14
Cylinders	20/18/15	20/18/15	20/18/15
Vane motors	20/18/15	19/17/14	18/16/13
Axial piston motors	19/17/14	18/16/13	17/15/12
Radial piston motors	20/18/14	19/17/13	18/16/13

Products we offer:

- Cartridge valves
- DCV directional control valves
- Electric converters
- Electric machines
- Electric motors
- Gear motors
- Gear pumps
- Hydraulic integrated circuits (HICs)
- Hydrostatic motors
- Hydrostatic pumps
- Orbital motors
- PLUS+1[®] controllers
- PLUS+1[®] displays
- PLUS+1[®] joysticks and pedals
- PLUS+1[®] operator interfaces
- PLUS+1[®] sensors
- PLUS+1[®] software
- PLUS+1[®] software services, support and training
- Position controls and sensors
- PVG proportional valves
- Steering components and systems
- Telematics

Danfoss Power Solutions is a global manufacturer and supplier of high-quality hydraulic and electric components. We specialize in providing state-of-the-art technology and solutions that excel in the harsh operating conditions of the mobile off-highway market as well as the marine sector. Building on our extensive applications expertise, we work closely with you to ensure exceptional performance for a broad range of applications. We help you and other customers around the world speed up system development, reduce costs and bring vehicles and vessels to market faster.

Danfoss Power Solutions – your strongest partner in mobile hydraulics and mobile electrification.

Go to www.danfoss.com for further product information.

We offer you expert worldwide support for ensuring the best possible solutions for outstanding performance. And with an extensive network of Global Service Partners, we also provide you with comprehensive global service for all of our components.

Local address:

Hydro-Gear

www.hydro-gear.com

Daikin-Sauer-Danfoss

www.daikin-sauer-danfoss.com

**Danfoss
Power Solutions (US) Company**
2800 East 13th Street
Ames, IA 50010, USA
Phone: +1 515 239 6000

**Danfoss
Power Solutions GmbH & Co. OHG**
Krokamp 35
D-24539 Neumünster, Germany
Phone: +49 4321 871 0

**Danfoss
Power Solutions ApS**
Nordborgvej 81
DK-6430 Nordborg, Denmark
Phone: +45 7488 2222

**Danfoss
Power Solutions Trading
(Shanghai) Co., Ltd.**
Building #22, No. 1000 Jin Hai Rd
Jin Qiao, Pudong New District
Shanghai, China 201206
Phone: +86 21 2080 6201