

Capabilities Brochure

# Vickers® by Danfoss Proportional Valves

Enabling creative solutions

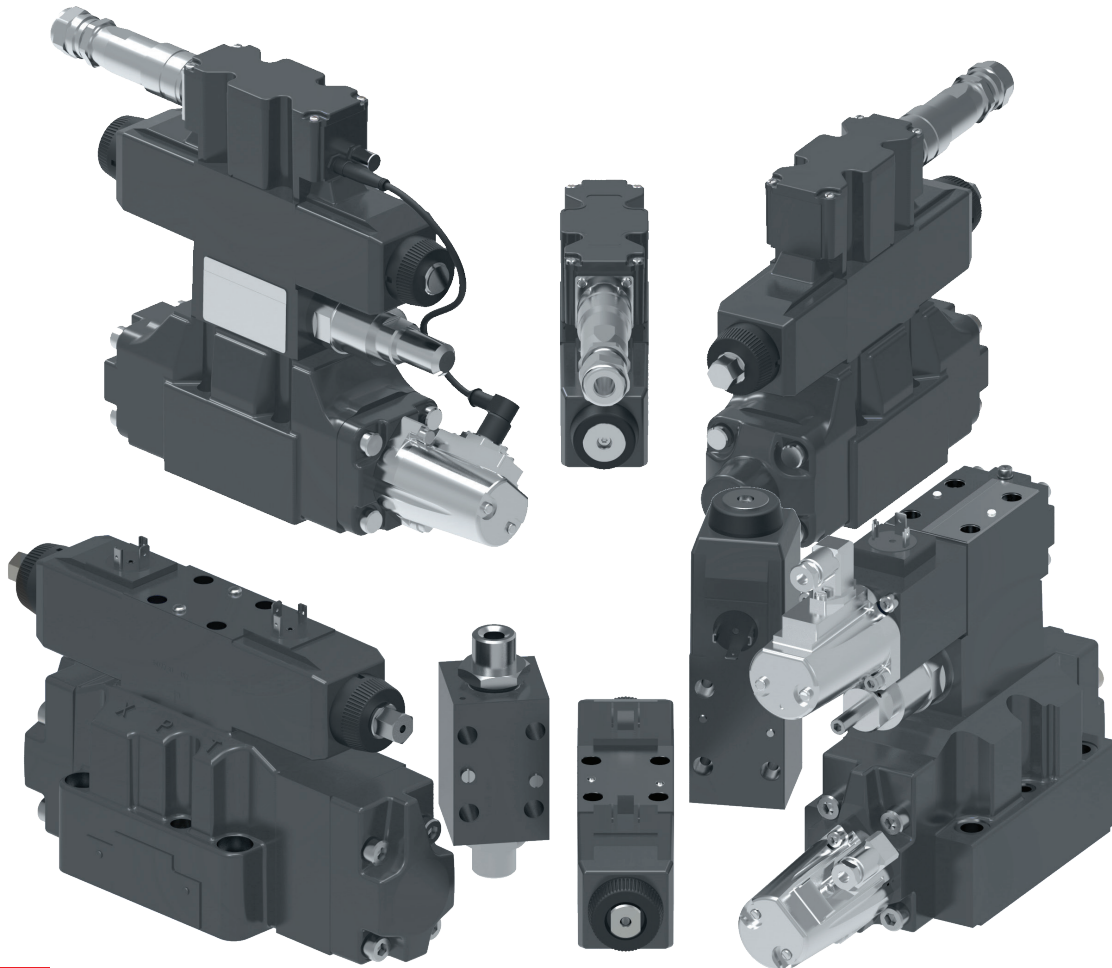

## Demanding applications **call for Vickers by Danfoss**

### **With a wide range of markets serviced, our KB proportional valves are enabling truly creative solutions.**

As technology continues to improve, so does the engineering Danfoss builds into its proportional valves. Vickers KB proportional valves are manufactured, sold, and supported throughout the world with the high quality you expect from Danfoss.

1. **Control function** - direction, flow, and pressure
2. **Performance levels** - standard high, and servo
3. **Onboard electronics** – with (KB model) and without (K model)
4. **Complete size range** – D03-D10 (NG6-NG32)
5. **Wide variety of supporting electronics**

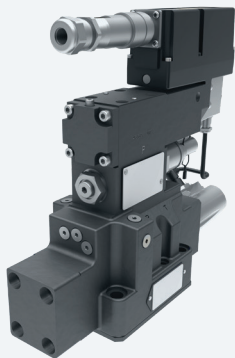

### **Integrated amplifiers mean “plug and play”**

Integrated amplifiers are factory preset and eliminate any adjustment of gain, dead-band compensation, or dither required for separate card and valve combinations. Plus they eliminate the need for field adjustments and separately wired and mounted. Replacement valves can be fitted without adjusting or changing the control signals.

### **New design means new applications**

With Vickers by Danfoss, KB proportional valves design engineers now have a new generation of integrated valves that redefine and expand industrial application design capabilities. Vickers proportional valves are much easier to install than previous models using separate drive amplifiers. The only electrical inputs required are a power supply and a command signal.

### **Built to last**

For durability, you cannot beat a KB proportional valve. The amplifier is housed in a durable metal enclosure, sealed against environmental contaminants such as cutting fluid spray, water, and fluid wash down. Seven-pin electrical mating connectors are supplied as standard. They are reliable, rugged, and provide easy access for test equipment.

Consistency of quality is assured with the KB proportional valve. Each valve/ amplifier combination is tested and calibrated as a total assembly with a variation of less than 5% from valve to valve. You can trust Vickers KB proportional valves to do the job as specified and perform consistently and reliably for years.



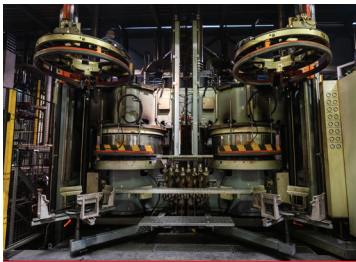

**Rubber press**



**Entertainment**



**Primary metal**

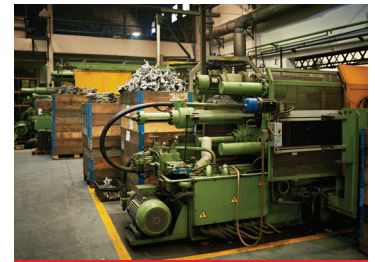

**Die casting**

PRIMARY MARKETS	SUBMARKETS	FORCE CONTROL	SPEED CONTROL	POSITION CONTROL
Machine Tool	Metal Cutting	X	X	X
	Material handling	X	X	X
Molding	Plastics and Rubber	X	X	X
	Die Casting	X	X	X
	Foundry	X	X	X
	Ceramic and Glass	X	X	X
Metal Forming	Press	X	X	X
	Baler	X	X	X
	Shear and Cutting	X	X	X
	Bending Machine	X	X	X
	Punching Machine	X	X	X
Primary Metal	Ferrous	X	X	X
	Non-Ferrous	X	X	X
	Wood Product	X	X	X
	Pulp and Paper	X	X	X
	Concrete and Aggregate	X	X	X
	Food	X	X	X

PRIMARY MARKETS	SUBMARKETS	FORCE CONTROL	SPEED CONTROL	POSITION CONTROL
Power Generation	Water Turbine	X		X
	Steam Turbine	X		X
	Wind Turbine	X		X
	Solar	X		X
Test and Stimulation		X	X	X
Mobile	Construction	X	X	X
	Mining	X	X	
	Agriculture	X	X	X
Oil and Gas		X	X	X
Marine		X	X	X
Civil Engineering		X	X	X

**Proportional valve application matrix**

The matrix to the right provides guidance for many industrial applications. Locate an application similar to yours, then read the recommended Valve Performance Level (Standard, High, or Servo Performance) at the top and the ISO Valve Size (Size 3, 5, 7, 8, or 10) on the right side.

The matrix uses "Frequency Response" as the primary determinant for valve performance. This is not the only parameter of importance in all applications, but it does serve as a good first reference.

**For example:**  
Sawmill Networks applications generally require Servo Performance type valves. The valve size could be either a Size 5 or a Size 7 depending upon the flow requirements of the application.

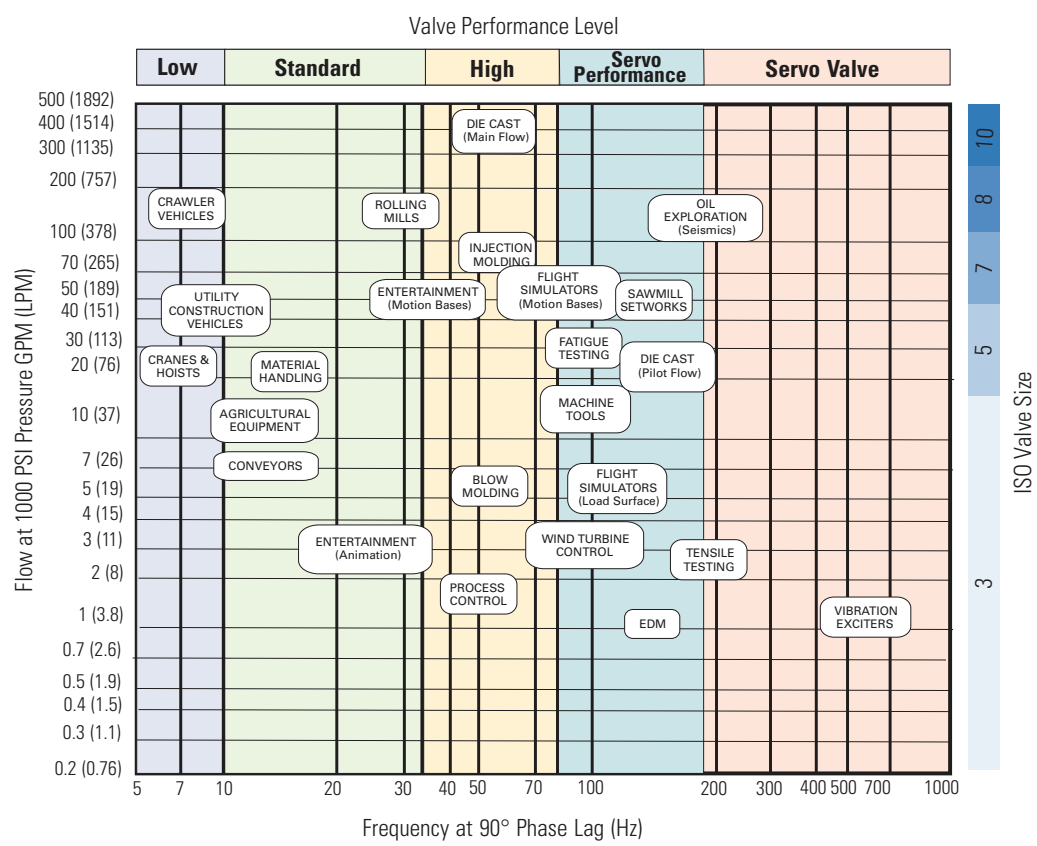



Press



Paper machine



Machine tool



Ceramic press

### Specifications, features, and benefits of KB prop valves

SPECIFICATION / FEATURES	BENEFITS
IP65 and 67 (best in class)	Superior moisture resistant
Valve enable	Easy to achieve interlock control
Ramp adjustment (digital OBE)	Ability to fine tune on site
Shock and vibration tested	Reliability and durability in harsh environment
Digital OBE (KBDG, KBFDG5V, KBCG, and KBXG)	Simpler setup with limited user adjustments
EMC CE marked	Passport selling to EU
±10 VDC & 4-20 mA command input options	Flexibility to match customer controller
Output monitor	Easy setup and diagnosis
Integrated onboard electronics (OBE)	Less wiring & more reliability
Factory preset gain and dead band	Plug and Play
Factory Calibration	No setup needed for replacement
Industry standard 7-pin connector	Interchangeability & ease of customer wiring
SMD techniques used in OBE	More compact design
24VDC with wide tolerance (21V to 36V)	Less demanding for power supply

Red fonts mean Danfoss' product superiority over competitors.

### OBE proportional valve comparison

SPECIFICATIONS/FEATURE	DANFOSS	BR	PARKER	ATOS
Environmental protection	IP65 and 67	IP65	IP54**	IP65
Ramp adjustment	Yes*	Not across board	No	Not across board
Valve enable	Yes	Not across board	Not across board	Not across board
OBE position	Pilot stage	Mostly on main stage	Main stage	Pilot stage
EMC qualification	CE marked	CE marked	CE marked	CE marked
Output monitor	Yes	Yes	Yes	Yes

\* Digital OBE valve: KBD(T)G4V, KBDG5V, KBFDG5V, KBX(C)G, KBCG, \*\*IP65 on limited number of families



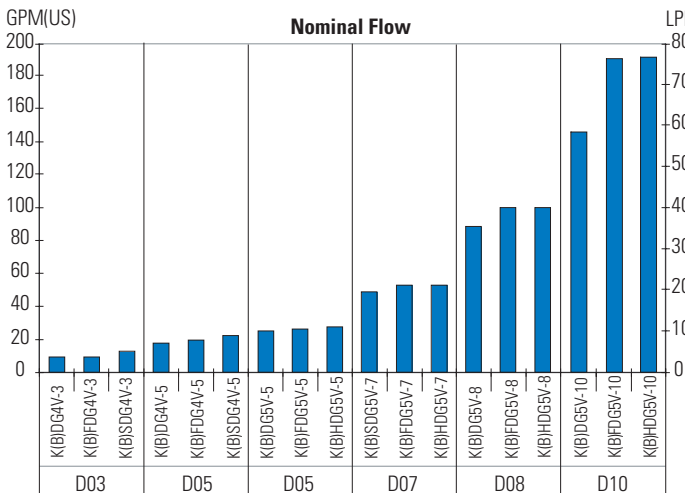



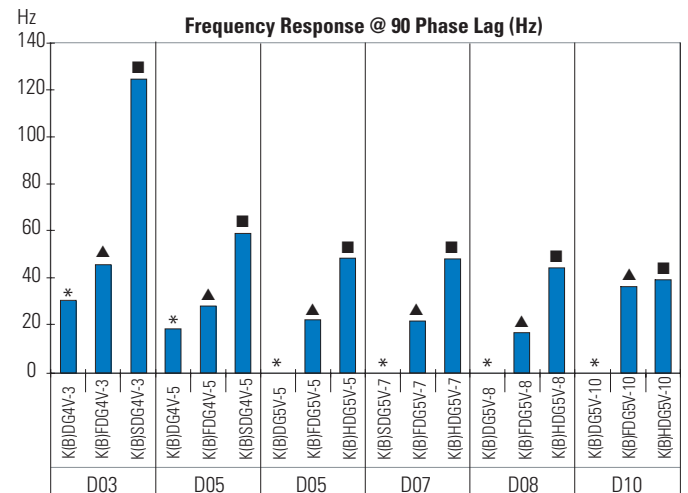





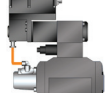

### Flow capability

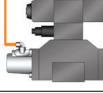
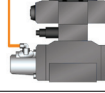
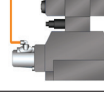







### Frequency response

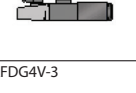
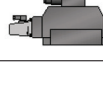
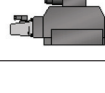
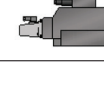
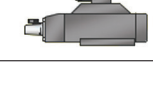
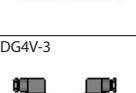

### Proportional directional valve with on-board-electronics (OBE)

	Single Stage D03/NG6	D05/NG10	Two Stage D05/NG16	D07/NG16	D08/NG25	D10/NG32
Servo Performance Valve with Dual Spool Feedback	KBSDG4V-3 		KBHDG5V-5 	KBHDG5V-7 	KBHDG5V-8 	KBHDG5V-10 
High Performance Valve with Single Spool Feedback	KBFDG4V-3 	KBFDG4V-5 	KBFDG5V-5 	KBFDG5V-7 	KBFDG5V-8 	KBFDG5V-10 
Standard Performance Valve without Spool Feedback	KBDG4V-3 	KBDG4V-5 	KBDG5V-5 	KBDG5V-7 	KBDG5V-8 	KBDG5V-10 

### Proportional directional valve without on-board-electronics (Non-OBE)

	Single Stage D03/NG6	D05/NG10	Two Stage D05/NG16	D07/NG16	D08/NG25	D10/NG32
Servo Performance Valve with Dual Spool Feedback	KSDG4V-3 		KHDG5V-5 	KHDG5V-7 	KHDG5V-8 	KHDG5V-10 
High Performance Valve with Single Spool Feedback	KFDG4V-3 					
Standard Performance Valve without Spool Feedback	KDG4V-3 	KDG4V-5 	KDG5V-5 	KDG5V-7 	KDG5V-8 	KDG5V-10 

### Amplifier (Euro card mounting)

Model Code	Proportional Valves
EEA-PAM-513-A/B/D-33	KCG-3, KCG-6/8, KX(C)G-6/8, H coil
EEA-PAM-523-A/B/C/D/E/F-33	KD/TG4V-3, KDG5V-5/7/8/10, H coil
EEA-PAM-525-A/B/C/D/E/F-33	KDG4V-5, H coil
EEA-PAM-533-A/B/C/D/E/F-33	KFD/TG4V-3
EEA-PAM-535-A/B/C/D/E/F-33	KFD/TG4V-5
EEA-PAM-541-A/D/E-33	KHDG5V-5/7/8/10, zero lap spool
EEA-PAM-553-A/D/E-33	KSDG4V-3
EEA-PAM-561-A/B/C/D/E/F-33	KFDG5V-5/7
EEA-PAM-568-A/B/C/D/E/F-33	KFDG5V-8
EEA-PAM-571-A/B/D-33	CVU-**-EFP1
EEA-PAM-581-A/B/D/E/F-33	KHDG5V-5/7/8/10

### Amplifier (Din-plug mounting)

Model Code	Description
EHH-AMP-702-D/J/K-30	Power Plugs for Proportional Valves, 24VDC
EHH-AMP-712-D/G-30	Power Plugs for Proportional Valves, 12VDC

### Functional module (Din-rail mounting)

Model Code	Description
EHD-DSG-201-A-10	Demand signal generator
EHA-PID-201-A-20	Electronic PID controller

### Others

Model Code	Description
EHA-TEQ-470-A 10	Portabe test box for KB and Axispro Valves

#### Notes:

A - with 2 ramps

B - A plus on-board command inputs



C - B plus additional 2 ramps

D - C plus PID module

E - A plus strip guidance module

F - A plus CNC adaptation module

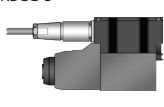
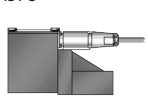
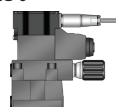

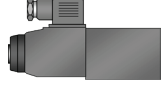
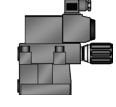
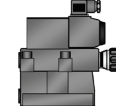

### Proportional pressure relief valve family

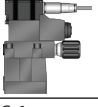
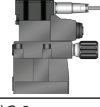
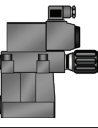
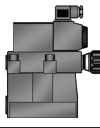
	Single Stage		Two Stage	
<b>OBE</b>	KBCG-3 	EHST-3 	KBCG-6 	KBCG-8 
<b>Non-OBE</b>	KCG-3 		KCG-6 	KCG-8 













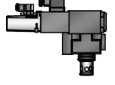
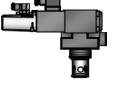
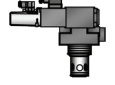
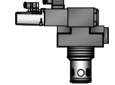
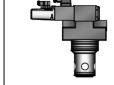
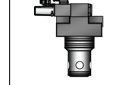
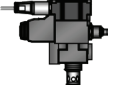

### Proportional pressure reducing valve family

	Single Stage		Two Stage	
<b>OBE</b>			KBX(C)G-6 	KBX(C)G-8 
<b>Non-OBE</b>			KX(C)G-6 	KX(C)G-8 

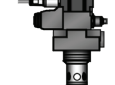
### Proportional throttle slip-in valve family – with main stage LVDT feedback

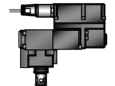
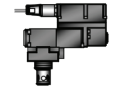
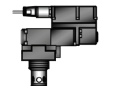
	NG16	NG25	NG32	NG40
<b>Non-OBE</b>	CVU-EFP1-16 	CVU-EFP1-25 	CVU-EFP1-32 	CVU-EFP1-40 

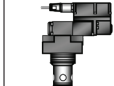
### Valvistor – proportional throttle slip-in cartridge valve family

	NG16	NG25	NG32	NG40	NG50	NG63
Non-OBE Pilot (KTG4V-3) Standard Performance	CVI & CVCS 16*HFV 	CVI & CVCS 25*HFV 	CVI & CVCS 32*HFV 	CVI & CVCS 40*HFV 	CVI & CVCS 50*HFV 	CVI & CVCS 63*HFV 
Non-OBE Pilot (KFTG4V-3) High Performance						
OBE Pilot (KBTG4V-3) Standard Performance						
OBE Pilot (KBFTG4V-3) High Performance						

## Primary applications



Press brake

Highly accurate positioning, repeatability of machining cycles, and precise synchronization control of cylinders during the closing movement of the bending tool, are prerequisites of the hydraulic control system.

### Product and system description

By using two K(B)F/SDG4V proportional valves for small tonnage machines, or two K(B) HDG5V valves for large tonnage machines in closed loops, Vickers valves provide the solution to this very demanding application. System control blocks provide full compliance to safety regulations.

### Benefits

High bending speed, with precise control of bending depth, results in greater productivity. The design of the safety system blocks reduces production and maintenance costs.



Injection molding machine

In order to improve productivity and quality, it is critical that the plasticizing process be precisely controlled. It requires accurate, repeatable, and smooth transition from velocity into pressure regulation. It is also imperative to achieve smooth, quick, and precise clamping movement.

### Product and system description

Servo performance proportional valves K(B)S/ HDG and high performance K(B) FDG families with tailored spool design, are the answer for meeting the extremely demanding injection and clamping control requirements. They have an excellent dynamic capability of closed loop control on pressure, position, and velocity.

### Benefits

Reduced cycle time and costs, with improved process control. One valve with a specially designed spool does all five critical controls of plasticizing, injection speed, holding pressure, decompression, worm return, and suck-back pressure. The “valve enable” feature on the KB line can be used to easily achieve interlock function.



Sawmill

Productivity is king. This transforms to the requirements of overall machine reliability and durability, and precise control, and short cycle time. Harsh environment is another challenge for proportional valves mounted on the machines; robustness against shock, vibration, EMC, dirt, and moisture is a must.

### Product and system description

Servo performance proportional valves K(B)S/HDG, with fully encapsulated OBE (EN90 version), provide extremely reliable protection in condition of vibrations and shock. Valves with zero lap spool and grounded spool/sleeve pilot stage are characterized by their highdynamic performance— with low hysteresis and high response sensitivity— to achieve accurate positioning control and speed control.

### Benefits

Onboard Electronics (OBE) valves feature “plug and play” to save wiring hassle and tuning time. IP 65 & 67 environment protection provide “best in industry” protection against moisture to make sure the proportional valves work reliably. When coupled with a Vickers servo cylinder, the proportional valves can be mounted directly onto the cylinder to become a servo actuator package.



Wind power

Wind power turbine control is a very demanding application that requires proportional valves to be extremely reliable and durable due to the nature of continuous production process. At the heart of advanced wind turbines is a hydraulic control system that controls the pitch angle of the turbine blades, hence controlling the speed and power production. Challenges are closed loop positioning control for precise pitch angle, and low and high ambient temperatures in extremely harsh environments.

### Product and system description

Coupled with servo cylinders, Vickers high performance proportional valves KBFDG provide a compact, rugged, and reliable package solution.

### Benefits

Digital Onboard Electronics (OBE) valves feature presetting the parameters with programming, which results better reproducibility and repeatability. Failsafe feature prevents the equipment from being damaged. IP 65 and 67 protection ratings mean Vickers valves provide better resistance to moisture than any competitors.



**Danfoss Power Solutions**, Nordborgvej 81, 6430 Nordborg, Denmark, Tel. +45 74 88 22 22, Fax +45 74 65 25 80  
[www.danfoss.com](http://www.danfoss.com), E-mail: [info@danfoss.com](mailto:info@danfoss.com)

Any information, including, but not limited to information on selection of product, its application or use, product design, weight, dimensions, capacity or any other technical data in product manuals, catalogues descriptions, advertisements, etc. and whether made available in writing, orally, electronically, online or via download, shall be considered informative, and is only binding if and to the extent, explicit reference is made in a quotation or order confirmation. Danfoss cannot accept any responsibility for possible errors in catalogues, brochures, videos and other material. Danfoss reserves the right to alter its products without notice. This also applies to products ordered but not delivered provided that such alterations can be made without changes to form, fit or function of the product. All trademarks in this material are property of Danfoss A/S or Danfoss group companies. Danfoss and the Danfoss logo are trademarks of Danfoss A/S. All rights reserved.