



REFRIGERATION AND
AIR CONDITIONING

INSTRUCTIONS

AK-CC 210 (115 V)



084R8007



R18MC65M

084R8007

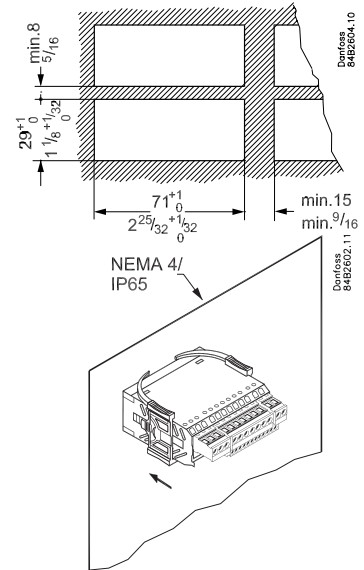
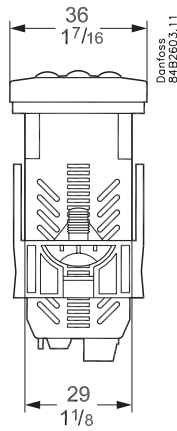
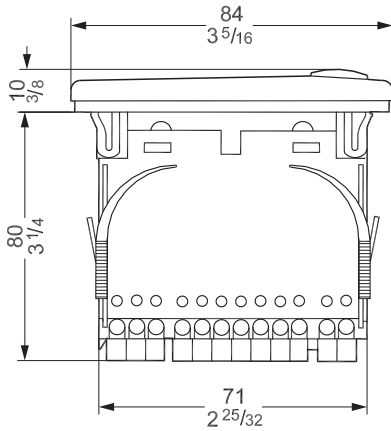

$t_{amb} = 0 - +55^{\circ}\text{C}, 32 - +131^{\circ}\text{F}$

115 V a.c., 50/60 Hz

2.5 VA

10V < U < 256 V

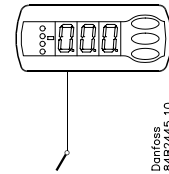
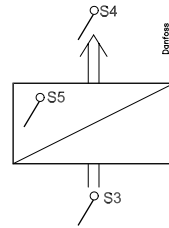
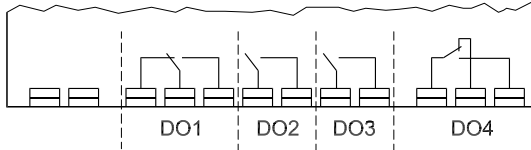

Type: Pt 1000 (1000 Ω / 0 $^{\circ}\text{C}$) /
Ptc 1000 (1000 Ω / 25 $^{\circ}\text{C}$) /
NTC-M2020 (5000 Ω / 25 $^{\circ}\text{C}$)

(o06)

	CE (250 V a.c.)	UL *** (240 V a.c.)
DO1. Refrigeration *	10 (6) A	10 A Resistive 5FLA, 30LRA
DO2. Defrost *	10 (6) A	10 A Resistive 5FLA, 30LRA
DO3. Fan or refrigeration 2 *	6 (3) A	6 A Resistive 3FLA, 18LRA 131 VA Pilot duty
DO4. Alarm, light, rail heat or hotgas defrost *	4 (1) A Min. 100 mA**	4 A Resistive 131 VA Pilot duty

* DO1 and DO2 are 16 A relays. DO3 and DO4 are 8 A relays. Max. load must be kept.
** Gold plating ensures make function with small contact loads
*** UL-approval based on 30000 couplings

Coordinated defrost

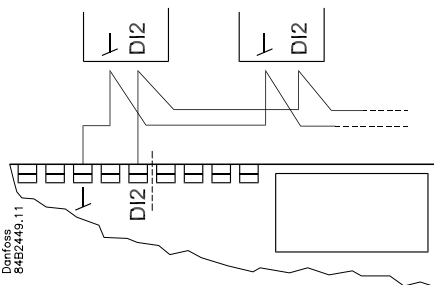

Data communication

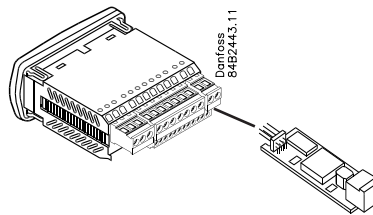

LON RS485

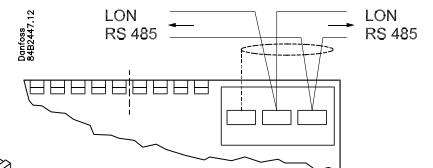

MOD-bus

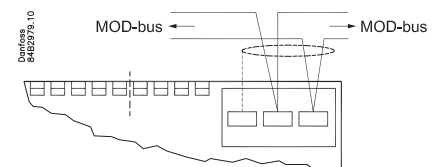

084R8007

o61 — Electrical connections

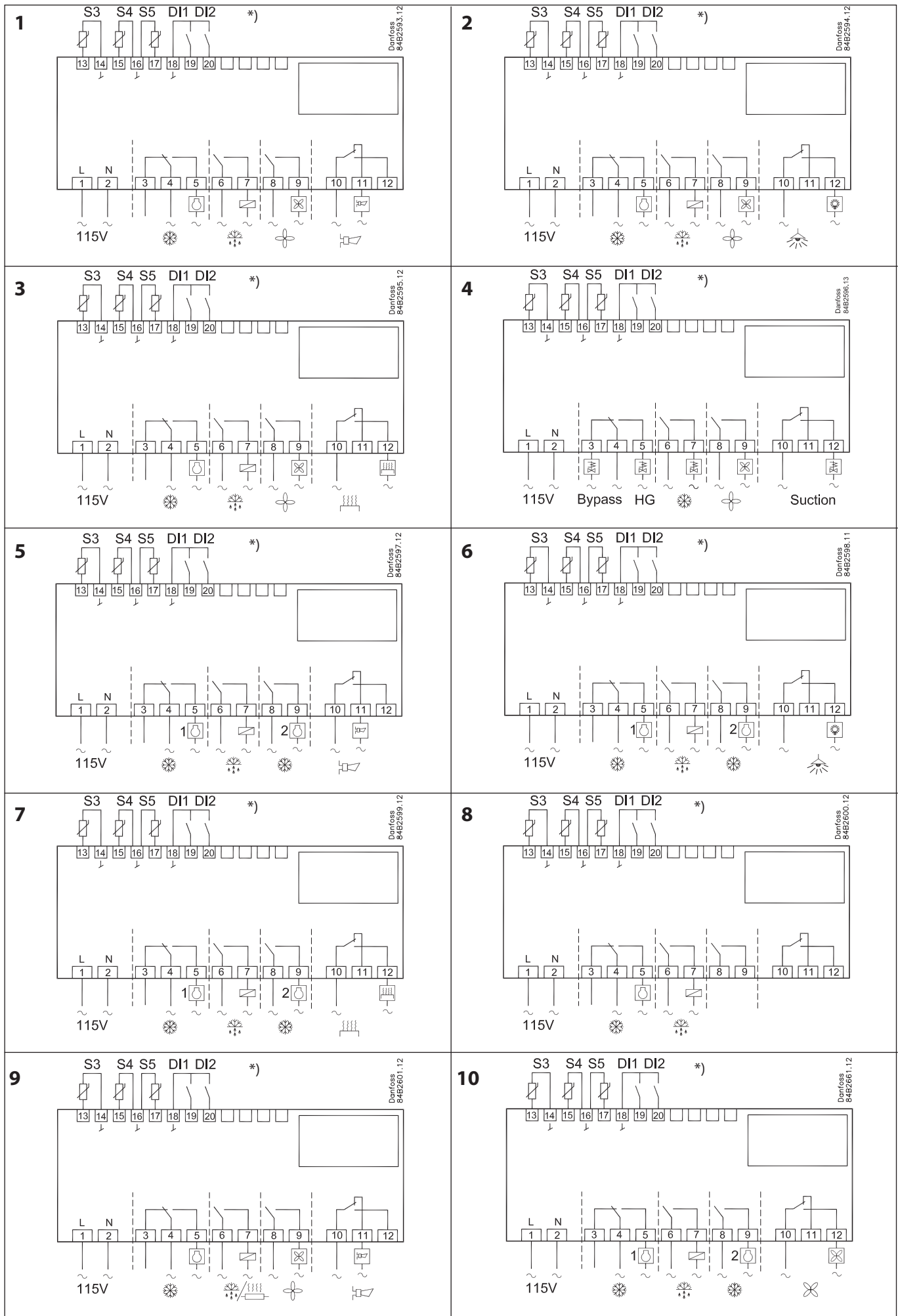

!!! →

***) DI1, DI2: AU: Guld, Gold, Or, Oro ℓ = max. 15 m**

Setting:

- 1 Open parameter r12 and stop the regulation
- 2 Select electric connection based on the drawings on page 2
- 3 Open parameter o61 and set the electric connection number in it
- 4 Now select one of the preset settings from the table on the right-hand side
- 5 Open parameter o62 and set the number for the array of presettings
- 6 Open parameter r12 and start the regulation
- 7 Go through the survey of factory settings. Make any necessary changes in the respective parameters.
- 8 For network. Set the address in o03 and then transmit it to the gateway/system unit with setting o04.

Auxiliary table for settings (quick-setup)	Case			Room		
	Defrost stop on time	Defrost stop on S5		Defrost stop on time	Defrost stop on S5	
Preset settings (o62)	1	2	3	4	5	6
Temperature (SP)	4°C	2°C	-24°C	6°C	3°C	-22°C
Max. temp. setting (r02)	6°C	4°C	-22°C	8°C	5°C	-20°C
Min. temp. setting (r03)	2°C	0°C	-26°C	4°C	1°C	-24°C
Sensor signal for thermostat. S4% (r15)	100%			0%		
Alarm limit high (A13)	10°C	8°C	-15°C	10°C	8°C	-15°C
Alarm limit low (A14)	-5°C	-5°C	-30°C	0°C	0°C	-30°C
Sensor signal for alarm funct.S4% (A36)	100%			0%		
Interval between defrost (d03)	6 h	6h	12h	8h	8h	12h
Defrost sensor: 0=time, 1=S5, 2=S4 (d10)	0	1	1	0	1	1
DI1 config. (o02)	Case cleaning =10			Door function =3		
Sensor signal for display view S4% (O17)	100%			0%		

Array 1-6: The settings in the grey fields will be changed

Function	Parameters	Codes	EL-diagram number (page 2)										Min.-value	Max.-value	Factory setting	Actual setting		
			1	2	3	4	5	6	7	8	9	10						
Normal operation																		
Temperature (set point)		---													-50.0°C	50.0°C	2.0°C	
Thermostat																		
Differential	***	r01													0.0 K	20.0K	2.0 K	
Max. limitation of setpoint setting	***	r02													-49.0°C	50°C	50.0°C	
Min. limitation of setpoint setting	***	r03													-50.0°C	49.0°C	-50.0°C	
Adjustment of temperature indication		r04													-20.0 K	20.0 K	0.0 K	
Temperature unit (°C/°F)		r05													°C	°F	°C	
Correction of the signal from S4		r09													-10.0 K	+10.0 K	0.0 K	
Correction of the signal from S3		r10													-10.0 K	+10.0 K	0.0 K	
Manual service, stop regulation, start regulation (-1, 0, 1)		r12													-1	1	0	
Displacement of reference during night operation		r13													-10.0 K	10.0 K	0.0 K	
Definition and weighting, if applicable, of thermostat sensors - S4% (100%=S4, 0%=S3)		r15													0%	100%	100%	
The heating function is started a number of degrees below the thermostats cutout temperature		r36													-15.0 K	-3.0 K	-15.0 K	
Activation of reference displacement r40		r39													OFF	ON	OFF	
Value of reference displacement (activate via r39 or DI)		r40													-50.0 K	50.0 K	0.0 K	
Alarm																		
Delay for temperature alarm		A03													0 min	240 min	30 min	
Delay for door alarm	***	A04													0 min	240 min	60 min	
Delay for temperature alarm after defrost		A12													0 min	240 min	90 min	
High alarm limit	***	A13													-50.0°C	50.0°C	8.0°C	
Low alarm limit	***	A14													-50.0°C	50.0°C	-30.0°C	
Alarm delay DI1		A27													0 min	240 min	30 min	
Alarm delay DI2		A28													0 min	240 min	30 min	
Signal for alarm thermostat. S4% (100%=S4, 0%=S3)		A36													0%	100%	100%	
Compressor																		
Min. ON-time		c01													0 min	30 min	0 min	
Min. OFF-time		c02													0 min	30 min	0 min	
Time delay for cutin of comp.2		c05													0 sec	999 sec	0 sec	
Compressor relay 1 must cutin and out inversely (NC-function)		c30													0	1	0	
															OFF	ON	OFF	
Defrost																		
Defrost method (none/EL/GAS/BRINE)		d01													no	bri	EL	
Defrost stop temperature		d02													0.0°C	25.0°C	6.0°C	
Interval between defrost starts		d03													0 hours	240 hours	8 hours	
Max. defrost duration		d04													0 min	180 min	45 min	
Displacement of time on cutin of defrost at start-up		d05													0 min	240 min	0 min	
Drip off time		d06													0 min	60 min	0 min	
Delay for fan start after defrost		d07													0 min	60 min	0 min	
Fan start temperature		d08													-15.0°C	0.0°C	-5.0°C	
Fan cutin during defrost		d09													0	2	1	
0: Stopped 1: Running 2: Running during pump down and defrost																		
Defrost sensor (0=time, 1=S5, 2=S4)		d10													0	2	0	
Pump down delay		d16													0 min	60 min	0 min	
Drain delay		d17													0 min	60 min	0 min	
Max. aggregate refrigeration time between two defrosts		d18													0 hours	48 hours	0 hours	
Defrost on demand - S5 temperature's permitted variation during frost build-up. On central plant choose 20 K (=off)		d19													0.0 K	20.0 k	20.0 K	
Delay of hot gas injection		d23													0 min	60 min	0 min	
Fan																		
Fan stop at cutout compressor		F01													no	yes	no	
Delay of fan stop		F02													0 min	30 min	0 min	
Fan stop temperature (S5)		F04													-50.0°C	50.0°C	50.0°C	

		1	2	3	4	5	6	7	8	9	10				
HACCP															
Actual temperature measurement for the HACCP function		h01													
Last registered peak temperature		h10													
Selection of function and sensor for the HACCP function. 0 = no HACCP function. 1 = S4 used (maybe also S3). 2 = S5 used		h11										0	2	0	
Alarm limit for the HACCP function		h12										-50.0°C	50.0°C	8.0°C	
Time delay for the HACCP alarm		h13										0 min.	240 min.	30 min.	
Select signal for the HACCP function. S4% (100% = S4, 0% = S3)		h14										0%	100%	100%	
Real time clock															
Six start times for defrost. Setting of hours. 0=OFF		t01-t06										0 hours	23 hours	0 hours	
Six start times for defrost. Setting of minutes. 0=OFF		t11-t16										0 min	59 min	0 min	
Clock - Setting of hours	***	t07										0 hours	23 hours	0 hours	
Clock - Setting of minute	***	t08										0 min	59 min	0 min	
Clock - Setting of date	***	t45										1	31	1	
Clock - Setting of month	***	t46										1	12	1	
Clock - Setting of year	***	t47										0	99	0	
Miscellaneous															
Delay of output signals after start-up		o01										0 s	600 s	5 s	
Input signal on DI1. Function: 0=not used. 1=status on DI1. 2=door function with alarm when open. 3=door alarm when open. 4=defrost start (pulse-pressure). 5=ext.main switch. 6=night operation 7=change reference (activate r40). 8=alarm function when closed. 9=alarm function when open. 10=case cleaning (pulse pressure). 11=forced cooling at hot gas defrost.		o02										1	11	0	
Network address (0=off)		o03										0	240	0	
On/Off switch (Service Pin message) IMPORTANT! o61 must be set prior to o04		o04										OFF	ON	OFF	
Access code 1 (all settings)		o05										0	100	0	
Used sensor type (Pt /PTC/NTC)		o06										Pt	ntc	Pt	
Display step = 0.5 (normal 0.1 at Pt sensor)		o15										no	yes	no	
Max hold time after coordinated defrost		o16										0 min	60 min	20	
Select signal for display view. S4% (100%=S4, 0%=S3)		o17										0%	100%	100%	
Input signal on DI2. Function: (0=not used. 1=status on DI2. 2=door function with alarm when open. 3=door alarm when open. 4=defrost start (pulse-pressure). 5=ext. main switch 6=night operation 7=change reference (activate r40). 8=alarm function when closed. 9=alarm function when open. 10=case cleaning (pulse pressure). 11=forced cooling at hot gas defrost.). 12=coordinated defrost)		o37										0	12	0	
Configuration of light function (relay 4) 1=ON during day operation. 2=ON / OFF via data communication. 3=ON follows the DI-function, when DI is selected to door function or to door alarm		o38										1	3	1	
Activation of light relay (only if o38=2)		o39										OFF	ON	OFF	
Rail heat On time during day operations		o41										0%	100%	100	
Rail heat On time during night operations		o42										0%	100%	100	
Rail heat period time (On time + Off time)		o43										6 min	60 min	10 min	
Case cleaning. 0=no case cleaning. 1=Fans only. 2=All output Off.	***	o46										0	2	0	
Selection of EL diagram. See overview page 2	*	o61										1	10	1	
Download a set of predetermined settings. See overview previous page.	*	o62										0	6	0	
Access code 2 (partly access)	***	o64										0	100	0	
Save the controllers present settings to the programming key. Select your own number.		o65										0	25	0	
Load a set of settings from the programming key (previously saved via o65 function)		o66										0	25	0	
Replace the controllers factory settings with the present settings		o67										OFF	On	OFF	
Service															
Status codes are shown on page 5		S0-S33													
Temperature measured with S5 sensor	***	u09													
Status on DI1 input. on/1=closed		u10													
Temperature measured with S3 sensor	***	u12													
Status on night operation (on or off) 1=closed	***	u13													
Temperature measured with S4 sensor	***	u16													
Thermostat temperature		u17													
Read the present regulation reference		u28													
Status on DI2 output. on/1=closed		u37													
Temperature shown on display		u56													
Measured temperature for alarm thermostat		u57													
Status on relay for cooling	**	u58													
Status on relay for fan	**	u59													
Status on relay for defrost	**	u60													
Status on relay for railheat	**	u61													
Status on relay for alarm	**	u62													
Status on relay for light	**	u63													
Status on relay for valve in suction line	**	u64													
Status on relay for compressor 2	**	u67													

*) Can only be set when regulation is stopped (r12=0)

**) Can be controlled manually, but only when r12=-1

***) With access code 2 the access to these menus will be limited

SW = 2.3x

Factory settings are indicated for standard units. Other code numbers have customized settings.

The buttons

Set menu

1. Push the upper button until a parameter r01 is shown
2. Push the upper or the lower button and find that parameter you want to change
3. Push the middle button until the parameter value is shown
4. Push the upper or the lower button and select the new value
5. Push the middle button again to enter the value.

Cutout alarm relay / receipt alarm/see alarm code

- Push short the upper button

Set temperature

1. Push the middle button until the temperature value is shown
2. Push the upper or the lower button and select the new value
3. Push the middle button to select the setting.

Reading the temperature at defrost sensor

- Push briefly the lower button

Manuel start or stop of a defrost

- Push the lower button for four seconds.

See HACCP registration

1. Give the middle button a long push until h01 appears
2. Select required h01-h10
3. See value by giving the middle button a short push

LED

Light emitting diode

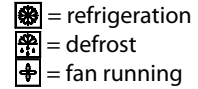

Flashes fast at alarm

HACCP

HACCP function is active

Fault code display		Alarm code display		Status code display	
E 1	Fault in controller	A 1	High temperature alarm	S0	Regulating
E 6	Change battery + check clock	A 2	Low temperature alarm	S 1	Waiting for end of the coordinated defrost
E 25	S3 sensor error	A 4	Door alarm	S 2	ON-time Compressor
E 26	S4 sensor error	A 5	Max. Hold time	S 3	OFF-time Compressor
E 27	S5 sensor error	A 15	DI 1 alarm	S 4	Drip-off time
		A 16	DI 2 alarm	S 10	Refrigeration stopped by main switch
		A 45	Standby mode	S 11	Refrigeration stopped by thermostat
		A 59	Case cleaning	S 14	Defrost sequence. Defrosting
		A 60	HACCP alarm	S 15	Defrost sequence. Fan delay
				S 17	Door open (open DI input)
				S 20	Emergency cooling
				S 25	Manual control of outputs
				S 29	Case cleaning
				S 30	Forced cooling
				S 32	Delay of output at start-up
				S33	Heat function r36 is active
				non	The defrost temperature cannot be displayed. There is stop based on time
				-d-	Defrost in progress
				PS	Password required

Setting:

- 1 Open parameter r12 and stop the regulation
- 2 Select electric connection based on the drawings on page 2
- 3 Open parameter o61 and set the electric connection number in it
- 4 Now select one of the preset settings from the table on the right-hand side
- 5 Open parameter o62 and set the number for the array of presettings
- 6 Open parameter r12 and start the regulation
- 7 Go through the survey of factory settings. Make any necessary changes in the respective parameters.
- 8 For network. Set the address in o03 and then transmit it to the gateway/system unit with setting o04.

Auxiliary table for settings (quick-setup)	Case			Room		
	Defrost stop on time	Defrost stop on S5		Defrost stop on time	Defrost stop on S5	
Preset settings (o62)	1	2	3	4	5	6
Temperature (SP)	39°F	36°F	-11°F	43°F	37°F	-8°F
Max. temp. setting (r02)	43°F	39°F	-8°F	46°F	41°F	-4°F
Min. temp. setting (r03)	36°F	32°F	-15°F	39°F	34°F	-11°F
Sensor signal for thermostat. S4% (r15)	100%			0%		
Alarm limit high (A13)	50°F	46°F	5°F	50°F	46°F	5°F
Alarm limit low (A14)	23°F	23°F	-22°F	32°F	32°F	-22°F
Sensor signal for alarm funct.S4% (A36)	100%			0%		
Interval between defrost (d03)	6 h	6h	12h	8h	8h	12h
Defrost sensor: 0=time, 1=S5, 2=S4 (d10)	0	1	1	0	1	1
DI1 config. (o02)	Case cleaning =10			Door function =3		
Sensor signal for display view S4% (017)	100%			0%		

Array 1-6: The settings in the grey fields will be changed

Function	Parameters	Codes	EL-diagram number (page 2)										Min.-value	Max.-value	Factory setting	Actual setting	
			1	2	3	4	5	6	7	8	9	10					
Normal operation																	
Temperature (set point)		---												-58.0°F	122.0°F	36.0°F	
Thermostat																	
Differential	***	r01												0°F	36.0°F	36.0°F	
Max. limitation of setpoint setting	***	r02												-56.0°F	122°F	122°F	
Min. limitation of setpoint setting	***	r03												-58.0°F	120°F	-58.0°F	
Adjustment of temperature indication		r04												-4.0°F	68.0°F	32.0°F	
Temperature unit (°C/°F)		r05												°C	°F	°F	
Correction of the signal from S4		r09												-18.0°F	+18.0°F	0.0°F	
Correction of the signal from S3		r10												-18.0°F	+18.0°F	0.0°F	
Manual service, stop regulation, start regulation (-1, 0, 1)		r12												-1	1	0	
Displacement of reference during night operation		r13												-18.0°F	+18.0°F	0.0°F	
Definition and weighting, if applicable, of thermostat sensors - S4% (100%=S4, 0%=S3)		r15												0%	100%	100%	
The heating function is started a number of degrees below the thermostats cutout temperature		r36												-27.0°F	-5.0°F	-22.0°F	
Activation of reference displacement r40		r39												OFF	ON	OFF	
Value of reference displacement (activate via r39 or DI)		r40												-90.0°F	90.0°F	0.0°F	
Alarm																	
Delay for temperature alarm		A03												0 min	240 min	30 min	
Delay for door alarm	***	A04												0 min	240 min	60 min	
Delay for temperature alarm after defrost		A12												0 min	240 min	90 min	
High alarm limit	***	A13												-58.0°F	122.0°F	46.0°F	
Low alarm limit	***	A14												-58.0°F	122.0°F	-22.0°F	
Alarm delay DI1		A27												0 min	240 min	30 min	
Alarm delay DI2		A28												0 min	240 min	30 min	
Signal for alarm thermostat. S4% (100%=S4, 0%=S3)		A36												0%	100%	100%	
Compressor																	
Min. ON-time		c01												0 min	30 min	0 min	
Min. OFF-time		c02												0 min	30 min	0 min	
Time delay for cutin of comp.2		c05												0 sec	999 sec	0 sec	
Compressor relay 1 must cutin and out inversely (NC-function)		c30												0	1	0	
														OFF	ON	OFF	
Defrost																	
Defrost method (none/EL/GAS/BRINE)		d01												no	bri	EL	
Defrost stop temperature		d02												32.0°F	77.0°F	43.0°F	
Interval between defrost starts		d03												0 hours	240 hours	8 hours	
Max. defrost duration		d04												0 min	180 min	45 min	
Displacement of time on cutin of defrost at start-up		d05												0 min	240 min	0 min	
Drip off time		d06												0 min	60 min	0 min	
Delay for fan start after defrost		d07												0 min	60 min	0 min	
Fan start temperature		d08												5.0°F	32.0°F	23.0°F	
Fan cutin during defrost		d09												0	2	1	
0: Stopped																	
1: Running																	
2: Running during pump down and defrost																	
Defrost sensor (0=time, 1=S5, 2=S4)		d10												0	2	0	
Pump down delay		d16												0 min	60 min	0 min	
Drain delay		d17												0 min	60 min	0 min	
Max. aggregate refrigeration time between two defrosts		d18												0 hours	48 hours	0 hours	
Defrost on demand - S5 temperature's permitted variation during frost build-up. On central plant choose 20 K (=off)		d19												0°F	36.0°F	36.0°F	
Delay of hot gas injection		d23												0 min	60 min	0 min	
Fan																	
Fan stop at cutout compressor		F01												no	yes	no	
Delay of fan stop		F02												0 min	30 min	0 min	
Fan stop temperature (S5)		F04												-58.0°F	122.0°F	122.0°F	

		1	2	3	4	5	6	7	8	9	10				
HACCP															
Actual temperature measurement for the HACCP function		h01													
Last registered peak temperature		h10													
Selection of function and sensor for the HACCP function. 0 = no HACCP function. 1 = S4 used (maybe also S3). 2 = S5 used		h11										0	2	0	
Alarm limit for the HACCP function		h12										-58.0°F	122.0°F	46.0°F	
Time delay for the HACCP alarm		h13										0 min.	240 min.	30 min.	
Select signal for the HACCP function. S4% (100% = S4, 0% = S3)		h14										0%	100%	100%	
Real time clock															
Six start times for defrost. Setting of hours. 0=OFF		t01-t06										0 hours	23 hours	0 hours	
Six start times for defrost. Setting of minutes. 0=OFF		t11-t16										0 min	59 min	0 min	
Clock - Setting of hours	***	t07										0 hours	23 hours	0 hours	
Clock - Setting of minute	***	t08										0 min	59 min	0 min	
Clock - Setting of date	***	t45										1	31	1	
Clock - Setting of month	***	t46										1	12	1	
Clock - Setting of year	***	t47										0	99	0	
Miscellaneous															
Delay of output signals after start-up		o01										0 s	600 s	5 s	
Input signal on DI1. Function: 0=not used. 1=status on DI1. 2=door function with alarm when open. 3=door alarm when open. 4=defrost start (pulse-pressure). 5=ext.main switch. 6=night operation 7=change reference (activate r40). 8=alarm function when closed. 9=alarm function when open. 10=case cleaning (pulse pressure). 11=forced cooling at hot gas defrost.		o02										1	11	0	
Network address (0=off)		o03										0	240	0	
On/Off switch (Service Pin message) IMPORTANT! o61 must be set prior to o04		o04										OFF	ON	OFF	
Access code 1 (all settings)		o05										0	100	0	
Used sensor type (Pt /PTC/NTC)		o06										Pt	ntc	Pt	
Display step = 0.5 (normal 0.1 at Pt sensor)		o15										no	yes	no	
Max hold time after coordinated defrost		o16										0 min	60 min	20	
Select signal for display view. S4% (100%=S4, 0%=S3)		o17										0%	100%	100%	
Input signal on DI2. Function: (0=not used. 1=status on DI2. 2=door function with alarm when open. 3=door alarm when open. 4=defrost start (pulse-pressure). 5=ext. main switch 6=night operation 7=change reference (activate r40). 8=alarm function when closed. 9=alarm function when open. 10=case cleaning (pulse pressure). 11=forced cooling at hot gas defrost.). 12=coordinated defrost)		o37										0	12	0	
Configuration of light function (relay 4) 1=ON during night operation. 2=ON / OFF via data communication. 3=ON follows the DI-function, when DI is selected to door function or to door alarm		o38										1	3	1	
Activation of light relay (only if o38=2)		o39										OFF	ON	OFF	
Rail heat On time during day operations		o41										0%	100%	100	
Rail heat On time during night operations		o42										0%	100%	100	
Rail heat period time (On time + Off time)		o43										6 min	60 min	10 min	
Case cleaning. 0=no case cleaning. 1=Fans only. 2=All output Off.	***	o46										0	2	0	
Selection of EL diagram. See overview page 2	*	o61										1	10	1	
Download a set of predetermined settings. See overview previous page.	*	o62										0	6	0	
Access code 2 (partly access)	***	o64										0	100	0	
Save the controllers present settings to the programming key. Select your own number.		o65										0	25	0	
Load a set of settings from the programming key (previously saved via o65 function)		o66										0	25	0	
Replace the controllers factory settings with the present settings		o67										OFF	On	OFF	
Service															
Status codes are shown on page 8		S0-S33													
Temperature measured with S5 sensor	***	u09													
Status on DI1 input. on/1=closed		u10													
Temperature measured with S3 sensor	***	u12													
Status on night operation (on or off) 1=closed	***	u13													
Temperature measured with S4 sensor	***	u16													
Thermostat temperature		u17													
Read the present regulation reference		u28													
Status on DI2 output. on/1=closed		u37													
Temperature shown on display		u56													
Measured temperature for alarm thermostat		u57													
Status on relay for cooling	**	u58													
Status on relay for fan	**	u59													
Status on relay for defrost	**	u60													
Status on relay for railheat	**	u61													
Status on relay for alarm	**	u62													
Status on relay for light	**	u63													
Status on relay for valve in suction line	**	u64													
Status on relay for compressor 2	**	u67													

*) Can only be set when regulation is stopped (r12=0)

**) Can be controlled manually, but only when r12=-1

***) With access code 2 the access to these menus will be limited

SW = 2.3x

Factory settings are indicated for standard units. Other code numbers have customized settings.

The buttons

Set menu

1. Push the upper button until a parameter r01 is shown
2. Push the upper or the lower button and find that parameter you want to change
3. Push the middle button until the parameter value is shown
4. Push the upper or the lower button and select the new value
5. Push the middle button again to enter the value.

Cutout alarm relay / receipt alarm/see alarm code

- Push short the upper button

Set temperature

1. Push the middle button until the temperature value is shown
2. Push the upper or the lower button and select the new value
3. Push the middle button to select the setting.

Reading the temperature at defrost sensor

- Push briefly the lower button

Manuel start or stop of a defrost

- Push the lower button for four seconds.

See HACCP registration

1. Give the middle button a long push until h01 appears
2. Select required h01-h10
3. See value by giving the middle button a short push

LED

Light emitting diode

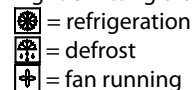

☐ = refrigeration

☐ = defrost

☐ = fan running

Flashes fast at alarm

HACCP

HACCP function is active

Fault code display		Alarm code display		Status code display	
E 1	Fault in controller	A 1	High temperature alarm	S0	Regulating
E 6	Change battery + check clock	A 2	Low temperature alarm	S 1	Waiting for end of the coordinated defrost
E 25	S3 sensor error	A 4	Door alarm	S 2	ON-time Compressor
E 26	S4 sensor error	A 5	Max. Hold time	S 3	OFF-time Compressor
E 27	S5 sensor error	A 15	DI 1 alarm	S 4	Drip-off time
		A 16	DI 2 alarm	S 10	Refrigeration stopped by main switch
		A 45	Standby mode	S 11	Refrigeration stopped by thermostat
		A 59	Case cleaning	S 14	Defrost sequence. Defrosting
		A 60	HACCP alarm	S 15	Defrost sequence. Fan delay
				S 17	Door open (open DI input)
				S 20	Emergency cooling
				S 25	Manual control of outputs
				S 29	Case cleaning
				S 30	Forced cooling
				S 32	Delay of output at start-up
				S33	Heat function r36 is active
				non	The defrost temperature cannot be displayed. There is stop based on time
				-d-	Defrost in progress
				PS	Password required

Español

Puesta en marcha rápida:

- 1 Entrar en el parámetro r12 para parar el equipo: r12 = 0.
- 2 Elegir la aplicación deseada a partir de los modelos de la página 2
- 3 Programar la aplicación elegida en o61.
- 4 Elegir una de las pre-programaciones básicas a partir de las opciones.
- 5 Programar la pre-programación deseada en o62.
- 6 Entrar nuevamente en el parámetro r12 para arrancar el equipo: r12 = 1.
- 7 Repasar los ajustes de fábrica por si hubiese que retocar alguno.
- 8 Si el equipo está conectado a un bus de comunicaciones, programar la dirección asignada en o03 y transmitirla a la gateway con o04.

Tabla de ajustes preprogramados (Puesta en marcha rápida)	Mueble			Cámara		
	Desescarche por tiempo	Desescarche por S5		Desescarche por tiempo	Desescarche por S5	
Preprogramación básica (o62)	1	2	3	4	5	6
Temperatura (SP)	4°C	2°C	-24°C	6°C	3°C	-22°C
Lím. máx. al ajustar temp. de corte (r02)	6°C	4°C	-22°C	8°C	5°C	-20°C
Lím. mín. al ajustar temp. de corte (r03)	2°C	0°C	-26°C	4°C	1°C	-24°C
Definición de la sonda del termostato % de S4(r15)	100%			0%		
Límite de alarma por alta temp. (A13)	10°C	8°C	-15°C	10°C	8°C	-15°C
Límite de alarma por baja temp. (A14)	-5°C	-5°C	-30°C	0°C	0°C	-30°C
Definición de la sonda de alarma % de S4 (A36)	100%			0%		
Intervalo entre desescarches (d03)	6 h	6h	12h	8h	8h	12h
Sonda de fin de desescarche 0=no, 1=S5, 2=S4 (d10)	0	1	1	0	1	1
Función entrada digital DI1 (o02)	Limpieza del mueble =10			Función de puerta =3		
Definición de la sonda en el display % de S4 (017)	100%			0%		

Conjunto 1-6: Los ajustes de las casillas en gris, serán modificados.

Función	Parámetros	Código	Número de esquema eléctrico										Valor mínimo	Valor máximo	Ajuste fábrica	Ajuste actual			
			1	2	3	4	5	6	7	8	9	10							
Funcionamiento normal																			
Temperatura de corte (set point)		---														-50.0°C	50.0°C	2.0°C	
Termostato																			
Diferencial del termostato		r01														0.1 K	20.0 K	2.0 K	
Límite máximo al ajustar la temperatura de corte		r02														-49.0°C	50.0°C	50.0°C	
Límite mínimo al ajustar la temperatura de corte		r03														-50.0°C	49.0°C	-50.0°C	
Corrección de la temperatura del display		r04														-20.0 K	20.0 K	0.0 K	
Unidades de temperatura (°C/°F)		r05														°C	°F	°C	
Calibración de la sonda S4		r09														-10.0 K	+10.0 K	0.0 K	
Calibración de la sonda S3		r10														-10.0 K	+10.0 K	0.0 K	
Marcha /paro interno: -1=modo manual, 0=OFF, 1=en marcha		r12														-1	1	0	
Desplazamiento de la temp. de corte durante la noche		r13														-10.0 K	10.0 K	0.0 K	
Definición de la sonda del termostato, % de S4 (100%=S4, 0%=S3)		r15														0%	100%	100%	
Decremento respecto a Tª de corte para empezar a calentar		r36														-15.0 K	-3.0 K	-15.0 K	
Activar el incremento de la temperatura de corte r40		r39														OFF	ON	OFF	
Incremento de la temperatura de corte (grados) (activación por r39 o DI)		r40														-50.0 K	50.0 K	0.0 K	
Alarma																			
Retardo de alarma de temperatura (estándar)		A03														0 min	240 min	30 min	
Retardo de alarma de puerta		A04														0 min	240 min	60 min	
Retardo de alarma de temp. (después del desescarche y al arrancar)		A12														0 min	240 min	90 min	
Límite de alarma por alta temperatura		A13														-50.0°C	50.0°C	8.0°C	
Límite de alarma por baja temperatura		A14														-50.0°C	50.0°C	-30.0°C	
Retardo de alarma asociada a DI1		A27														0 min	240 min	30 min	
Retardo de alarma asociada a DI2		A28														0 min	240 min	30 min	
Definición sonda de alarma % de S4 (100%=S4, 0%=S3)		A36														0%	100%	100%	
Compresor																			
Mínimo tiempo de compresor en marcha (minutos)		c01														0 min	30 min	0 min	
Mínimo tiempo entre dos arranques consecutivos (minutos)		c02														0 min	30 min	0 min	
Retraso en arrancar el 2º compresor		c05														0 sec	999 sec	0 sec	
Invertir el funcionamiento de la salida DO1 (compresor)		c30														0	1	0	
																OFF	ON	OFF	
Desescarche																			
Tipo de desescarche (none/EL/GAS/BRINE=salmuera)		d01														no	bri	EL	
Temperatura de fin de desescarche		d02														0.0°C	25.0°C	6.0°C	
Intervalo de tiempo entre desescarches		d03														0 hours	240 hours	8 hours	
Duración máxima del desescarche		d04														0 min	180 min	45 min	
Desplaz. del 1º desescarche tras dar tensión al equipo		d05														0 min	240 min	0 min	
Tiempo de goteo		d06														0 min	60 min	0 min	
Retardo del ventilador tras el desescarche		d07														0 min	60 min	0 min	
Temperatura arranque ventilador		d08														-15.0°C	0.0°C	-5.0°C	
Ventilador en marcha durante desescarche (no/yes)		d09														0	2	1	
0: parado																			
1: en marcha																			
2: en marcha durante el vaciado y el desescarche																			
Sonda de fin de desescarche (0=no, 1=S5, 2=S4)		d10														0	2	0	
Tiempo de vaciado del evaporador (antes del inicio desescarche)		d16														0 min	60 min	0 min	
Tiempo de drenaje con válvula by-pass (sólo gas caliente)		d17														0 min	60 min	0 min	
Desescarche bajo demanda: tiempo acumulado refrigerando		d18														0 hours	48 hours	0 hours	
Desescarche bajo demanda: variación permitida a S5		d19														0.0 K	20.0 k	20.0 K	
Retardo de desescarche por gas caliente		d23														0 min	60 min	0 min	
Ventiladores																			
Parar ventilador al parar compresor		F01														no	yes	no	

Retardo de parada del ventilador	F02																	0 min	30 min	0 min		
Temperatura de paro del ventilador (medida con S5)	F04																	-50.0°C	50.0°C	50.0°C		
			1	2	3	4	5	6	7	8	9	10										
HACCP																						
Medida de temp. actual para la función HACCP	h01																					
Última temperatura pico registrada	h10																					
Selección de función y sonda para la función HACCP. 0=sin función HACCP, 1= 4 y/o S3 (ver h14) 2=S5 usado.	h11																	0	2	0		
Límite de alarma para la función HACCP.	h12																	-50.0°C	50.0°C	8.0°C		
Retraso de tiempo para la alarma HACCP	h13																	0 min.	240 min.	30 min.		
Seleccionar sonda para la función HACCP. S4 y/o S3 (100%= S4, 0%= S3)	h14																	0	100%	100%		
Reloj de tiempo real																						
Hasta seis horas (hh) de inicio de desescarche (0=OFF)	t01-t06																	0 hours	23 hours	0 hours		
Los minutos (mm) de cada una de las 6 horas (0=OFF)	t11-t16																	0 min	59 min	0 min		
Ajuste de reloj: hora	t07																	0 hours	23 hours	0 hours		
Ajuste de reloj: minutos	t08																	0 min	59 min	0 min		
Ajuste de reloj: día	t45																	1	31	1		
Ajuste de reloj: mes	t46																	1	12	1		
Ajuste de reloj: año	t47																	0	99	0		
Varios																						
Retardo de activación de salidas al dar tensión al equipo	o01																	0 s	600 s	5 s		
Función de la entrada digital DI1: 0=no utilizada, 1=co- munica el estado de la DI, 2=puerta abierta y alarma, 3=sólo la alarma de puerta 4=pulso para iniciar un des- escarche 5=interruptor principal 6=operación nocturna 7=desplazamiento temperatura de corte (activación r40). 8=alarma al cerrar el contacto 9=alarma al abrir el contacto 10=limpieza del mueble (pulso) 11=forzar frío (gas caliente)	o02																	1	11	0		
Dirección del AK (0=OFF)	o03																	0	200	0		
Enviar la dirección del AK a la gateway IMPORTANTE: se debe ajustar o61 antes que o04	o04																	OFF	ON	OFF		
Código de acceso nivel 1 (0=código desactivado)	o05																	0	100	0		
Tipo de sonda utilizada (Pt /PTC/NTC)	o06																	Pt	ntc	Pt		
Precisión del valor de display: YES=0.5, no =0.1	o15																	no	yes	no		
Máx. tiempo de espera tras un desescarche coordinado	o16																	0 min	60 min	20		
Definición de la sonda en display, %S4 (100%=S4, 0%=S3)	o17																	0%	100%	100%		
Función de la entrada digital DI2: 0=no utilizada. 1=co- munica el estado de la DI. 2=puerta abierta y alarma 3=sólo la alarma de puerta. 4=pulso para iniciar un des- escarche. 5=interruptor principal 6=operación nocturna 7=desplazamiento temperatura de corte (activación r40). 8=alarma al cerrar el contacto. 9=alarma al abrir el contacto. 10=limpieza del mueble (pulso). 11=forzar frío (gas caliente). 12=desescarche coordinado.	o37																	0	12	0		
Función de luz (relé 4 en aplicaciones 2 y 6) 1=ON durante operación día. 2=ON / OFF vía bus de comunicaciones. 3=ON a la vez que la DI cuando esa DI es para la función de puerta ó alarma de puerta.	o38																	1	3	1		
Activación del relé de luz vía bus de comunicaciones (sólo si o38=2)	o39																	OFF	ON	OFF		
Funcionamiento de antivaho durante el día (% sobre o43)	o41																	0%	100%	100		
Funcionamiento de antivaho durante la noche (% sobre o43)	o42																	0%	100%	100		
Periodo total de funcionamiento de antivaho (ciclo)	o43																	6 min	60 min	10 min		
Limpieza del mueble: 0 = no activo, 1 = sólo el ventila- dor en ON, 2 = todas las salidas en OFF	o46																	0	2	0		
Tipo de aplicación (ver opciones en el manual, página 2)	o61*																	1	10	1		
Tipo de pre-programación básica (ver opciones en el manual, página 9)	o62*																	0	6	0		
Código de acceso nivel 2 (0=desactivar código)	o64																	0	100	0		
Salvar la programación de un AK en una "copy-key"	o65																	0	25	0		
Volcar la programación desde una "copy-key" a un AK	o66																	0	25	0		
Sustituir los "ajustes de fábrica" por la programación actual	o67																	OFF	On	OFF		
Parámetros informativos (servicio)																						
Los códigos de estado se muestran en la página 11	S0-S33																					
Temperatura medida con la sonda S5	u09																					
Estado de la entrada DI1 (OFF=contacto abierto/ ON=contacto cerrado)	u10																					
Temperatura medida con la sonda S3	u12																					
Operación nocturna (OFF=no activa/ON=activa)	u13																					
Temperatura medida con la sonda S4	u16																					
Temperatura medida con la "sonda de corte" (S4%)	u17																					
Temperatura de corte (set point)	u28																					
Estado de la entrada DI2 (OFF=contacto abierto/ ON=contacto cerrado)	u37																					
Temperatura medida con la "sonda de display" (S4%)	u56																					
Temperatura medida con la "sonda de alarma" (S4%)	u57																					
** Estado del relé de frío	u58																					
** Estado del relé de ventilador	u59																					
** Estado del relé de desescarche	u60																					
** Estado del relé de antivaho	u61																					
** Estado del relé de alarma	u62																					
** Estado del relé de luz	u63																					
** Estado del relé de válvula de aspiración	u64																					
** Estado del relé para compresor 2	u67																					

Los botones

Ajustar parámetros

1. Pulsar el botón superior hasta que aparece el parámetro r01.
2. Pulsar los botones alto y bajo hasta encontrar el parámetro deseado.
3. Pulsar el botón central para ver el valor actual.
4. Pulsar los botones alto y bajo para modificar el valor.
5. Pulsar el botón central para confirmar el nuevo valor..

Rearmar el relé de alarma/ver el código de alarma

- Pulsar y soltar el botón alto
- Si hay varios códigos de alarmas activos, se verán cíclicamente pulsando sucesivamente el botón alto ó bajo.

Ajustar la temperatura de corte

1. Pulsar el botón central para ver el valor actual.
2. Pulsar los botones alto y bajo para modificar el valor.
3. Pulsar el botón central para confirmar el nuevo valor.

Leer la temperatura de la sonda de desescarche

- Pulsar y soltar el botón bajo

Iniciar/para un desescarche manualmente

- Pulsar y mantener el botón bajo 4s.

Ver registro HACCP

1. Pulsar el botón central continuamente hasta que aparezca h01.
2. Pulsar los botones alto y bajo para seleccionar el parámetro deseado h01-h10.
3. Pulsar el botón central para leer el valor del parámetro

LED's en el Display

LED's lunimosos

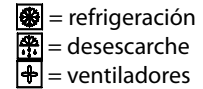

Parpadean cuando hay alarma

HACCP

La función HACCP está activada

Códigos para informar de fallos		Códigos para informar de alarmas		Códigos de estado	
E 1	Fallo del controlador	A 1	Alarma por alta temperatura	S0	Enfriando
E 6	Fallo del reloj (comprobar pila y "resetear" reloj)	A 2	Alarma por baja temperatura	S 1	esperando el final del desescarche coordinado
E 25	Error sonda S3	A 4	Alarma de puerta	S 2	Compresor dentro del mín. tiempo en marcha.
E 26	Error sonda S4	A 5	El tiempo de espera tras desescarche coordinado (o16) ha expirado	S 3	Compresor mín. tiempo entre arranques consecutivos.
E 27	Error sonda S5	A 15	Alarma asociada a DI 1	S 4	Tiempo de goteo en curso.
		A 16	Alarma asociada a DI 2	S 10	Equipo parado (desde r12 ó desde DI)
		A 45	AK parado (ya sea por "r12" ó por una DI)	S 11	Refrigeración parada. (Se ha alcanzado la temperatura de corte).
		A 59	Limpieza de mueble	S 14	Desescarchando
		A 60	Alarma por alta temperatura para la función HACCP	S 15	Retraso del ventilador tras desescarche.
				S 17	Puerta abierta
				S 20	Refrigeración en emergencia.
				S 25	Control manual, forzado, activo.
				S 29	Limpieza del mueble
				S 30	Frío forzado
				S 32	Retraso inicial al dar tensión al equipo
				S33	Calentando (r36 activo)
				non	No se puede mostrar la temperatura de desescarche. No hay sonda
				-d-	Se está realizando un desescarche
				PS	PS: introduzca contraseña (Código de acceso)

SW = 2.3x

*) Sólo pueden ajustarse si el AK está parado (r12=0)

**) Pueden operarse manualmente si r12=-1

***) Con código de acceso 2, el acceso a estos menús será limitado.

