

Installation guide – Spare parts and accessories

Repair kit | Code number 148B6065  
SVA-S/L, SVA-ST/LT, SVA-HS, SCA/X size 80

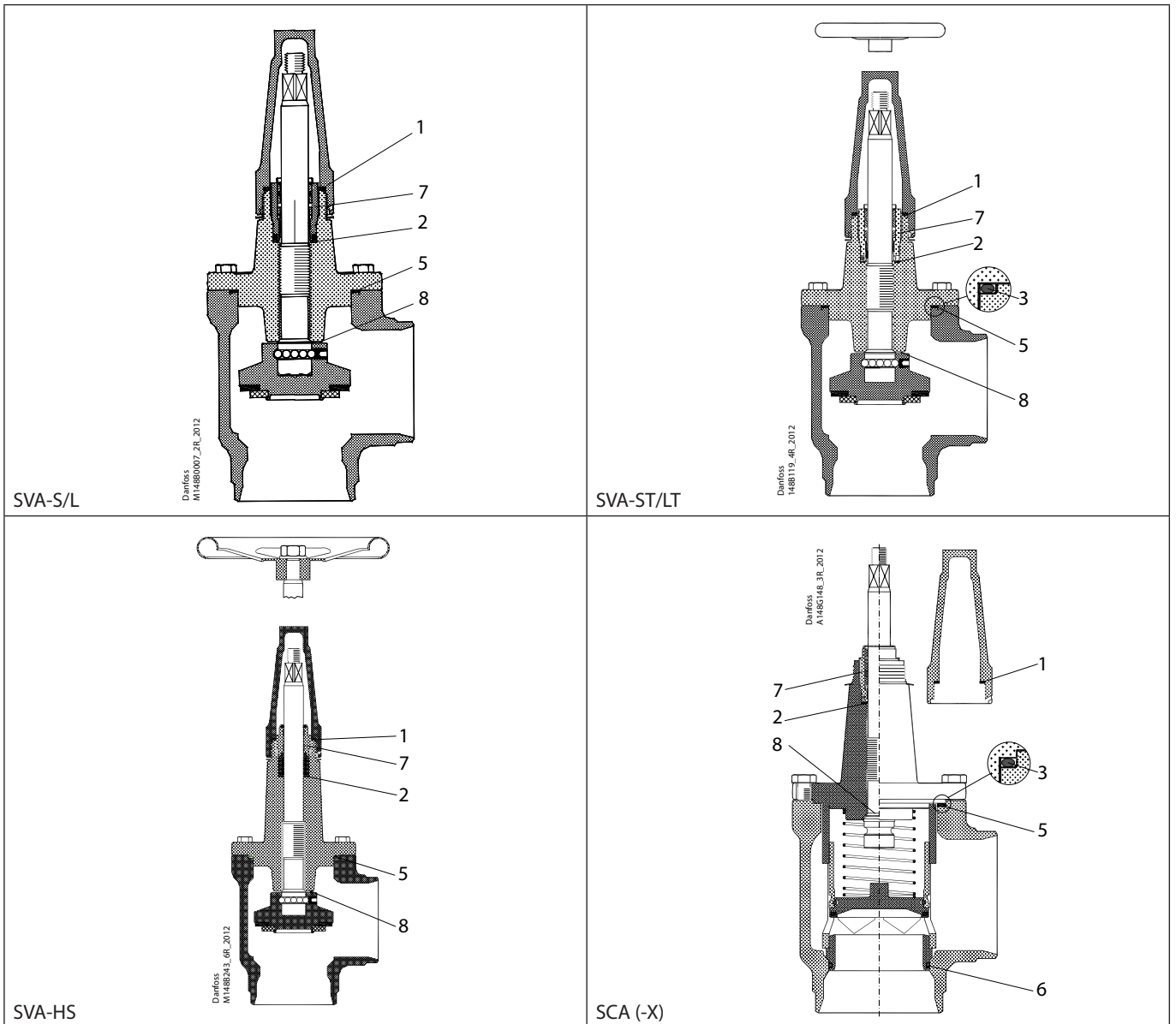

<p><b>1</b></p> <p> = Nylon</p> <p>Total no. = 1</p>	<p><b>2</b></p> <p> = Alu.</p> <p>Total no. = 1</p>	<p><b>3</b></p> <p>Total no. = 1</p>	<p><b>5</b></p> <p> = Fibre</p> <p>Total no. = 1</p>	<p><b>6</b></p> <p>Total no. = 1</p>
<p><b>7</b></p> <p>Total no. = 1</p>	<p><b>8</b></p> <p> = PTFE</p> <p>Total no. = 1</p>			

**NOTE:** When replacing the packing gland (pos. 7) in SVA-ST, SVA-S/L, SVA-HS, SCA-X and SCA the aluminium gasket (pos. 2) is needed.