

Data Sheet

Electric expansion valve Type **ETS 5M**

For liquid injection into evaporators

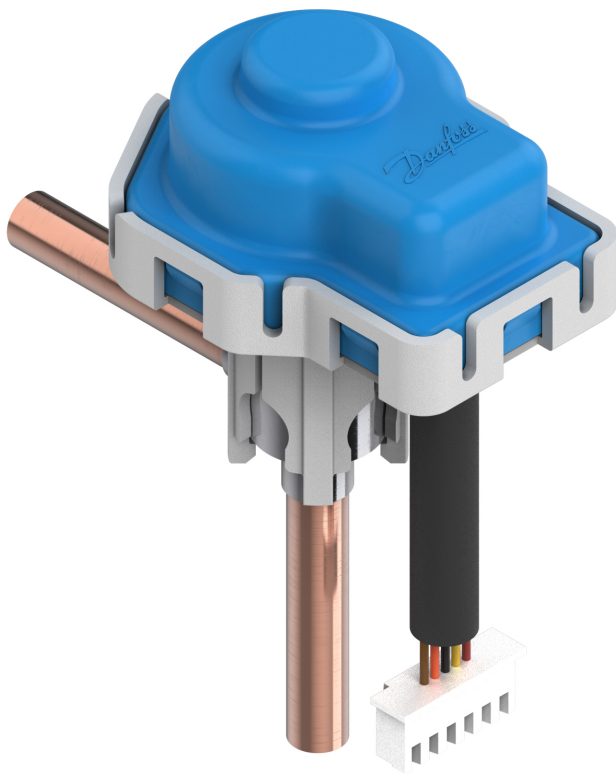

ETS 5M is a compact and lightweight stepper motor driven electric expansion valve with a high level of reliability, and it provides a precise solution for expansion and flow control in a wide range of refrigeration and air conditioning systems.

The portfolio is available with a wide capacity range and is designed for use with fluorinated refrigerants.

ETS 5M can be applied for applications i.e VRF, IT cooling, Heatpump, Mini Chiller, Bus / Transport application in single/biflow operation.

Valve operation is by means of a uni-polar motor, and as such it is compatible with a number of electronic controllers from Danfoss or third-party vendors. With an EKE1 series superheat controllers and AKS sensor, a superheat accuracy better than ± 0.5 K can be obtained.

Features

- Low flow noise and operation noise.
- Optimized valve flow characteristic.
- Accurate valve control, also at low opening degrees.
- Bi-flow, with full performance in both flow directions.
- Higher degree of freedom of installation orientation.
- Future-proof regarding refrigerants.
- Compatible with existing valve drivers.
- Largest nominal capacity, R410A : 41.0 kW, 11.6 TR.

Portfolio overview

ETS 5M is a system product whose function is controlled through a Danfoss electronic controller, or a third party vendor electronic controller that is compatible with the ETS 5M as to control functionality and connections.

Danfoss recommends the use of the EKE1 series superheat controller together with ETS 5M. With EKE1 series or similar Danfoss electronic controllers, a superheat accuracy better than 0.5 K can be obtained.

The electronic controller requires precise temperature input from a temperature sensor (refrigerant temperature) and precise pressure inputs (evaporator pressure) from a pressure transmitter.



System product

Figure 1: EKE 1 series superheat controllers (EKE 1B is shown)



EKE superheat controllers are for DIN rail mounting, and comes in three versions with different combinations of inputs and output relays and different functionality.

Table 1: Sensors and other products for ETS 5M

Pressure transmitter (DST P110 shown)	EKF 1A/2A Stepper Valve Driver	EKE 2U Backup power module
		
<p>DST P110 is a digital ratiometric pressure transmitter. Depending on controller type, other ratiometric pressure transmitters can be used as well (e.g. AKS 32R).</p>	<p>EKF series is an economical stepper valve driver that translates analog signal provided by master controller to valve driving sequence .</p>	<p>EKE 2U Backup power module ensures sufficient power in case of power failures to the controller to ensure closure of the electronic valves.</p>

Applications

Figure 2: Typical application of ETS 5M

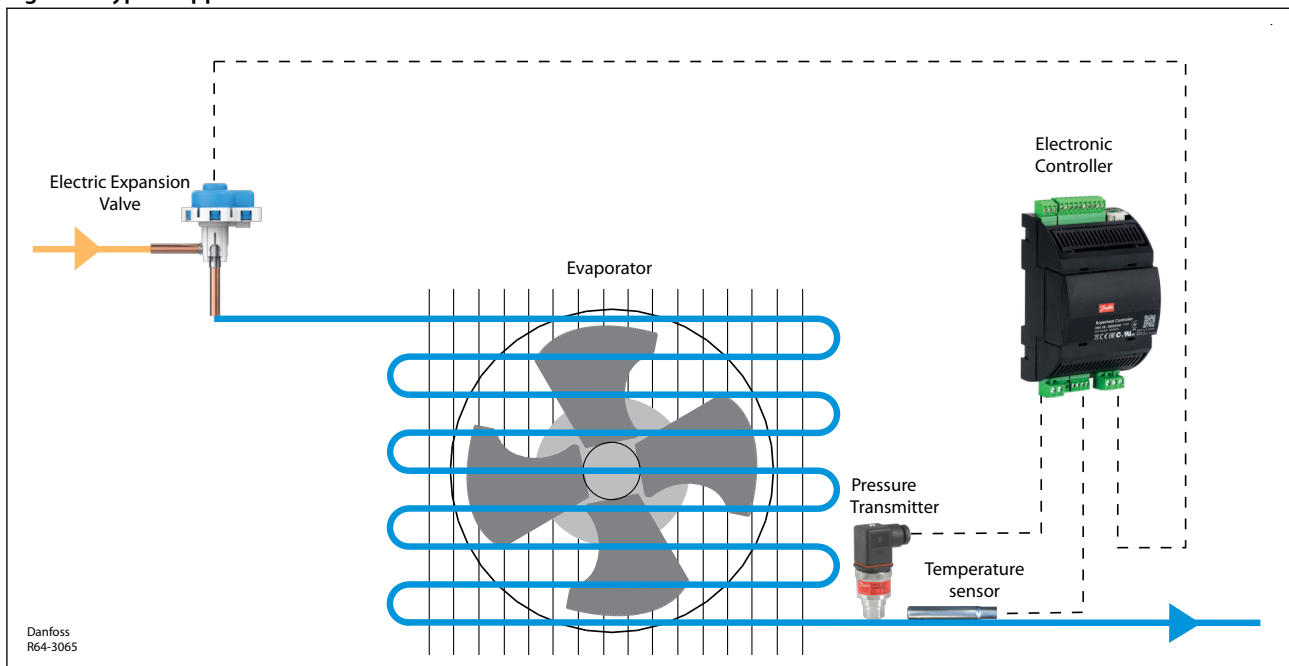

i NOTE:

ETS 5M 13-24 can be used in oil-free system but with limited MOPD 27 bar.

Media

ETS 5M is designed for use with fluorinated refrigerants with suitable lubricants.

Table 2: ETS 5M media data

Media data	Value
Refrigerants	R410A, R32, R290, R22, R454C, R515B, R1234ze, R452B, R1234yf, R452A, R454B, R454A, R455A, R449A, R407C, R134a, R407H, R513A, R449B, R404A, R448A, R463A
Refrigerants oil	POE, PVE, PAG, MO

NOTE:

For flammable refrigerants (R454C, R454A, R1234ze, R290, R32, R452B, R454B, R455A, R1234yf):

- This product is validated in accordance to ATEX, EN 378, ISO 5149, ASHRAE 15, IEC 60335-2-x or equivalent standards.
- Ignition risk is evaluated in accordance to ISO 5149 and IEC 60335.
- See safety note below.

NOTE:

- The product can be applied on systems with R454C, R454A, R1234ze, R290, R32, R452B, R454B, R455A, R1234yf as the working fluid.
- For countries where safety standards are not an indispensable part of the safety system Danfoss recommend the installer to get a third party approval of the system containing flammable refrigerant.
- Note, please follow specific selection criteria stated in the datasheet for these particular refrigerants.
- The valve must only be used in closed circuit refrigeration system, where no oxygen is present acc. EN 378, ISO 5149 ASHRAE 15 or IEC 60335-2-x or equivalent standards.

Product specification

Design

The ETS 5M Electric expansion valves open and close to regulate refrigerant flow by means of a screw, whose rotating motion is transformed into linear motion. This occurs by the rotation of a magnetneedle valve assembly which moves when electrical signals are applied to the surrounding coil. Within the coil structure, there are different winding configurations, and the polarities are changed by the electrical signals applied.

By application of the appropriate combination of signals, in the form of pulses, the coil forces the rotor of the valve to move in a stepwise fashion. Application of multiple pulses will make the valve mechanism move through a series of steps in the chosen direction, in order to set the valve with the required opening degree.

Pressure and temperature data

Table 3: Pressure and temperature data in SI and Imperial units

Data		Value [SI units]	Value [IMP. units]
Max working pressure (MWP)		49 barg	770 psig
Burst pressure		5 x MWP	5 x MWP
Maximum operating pressure differential (MOPD) ⁽¹⁾	ETS 5M 13 - 24	A->B 35 barg B->A 35 barg	A->B 508 Psig B->A 508 Psig
	ETS 5M 25 - 40	A->B 42 barg B->A 42 barg	A->B 609 Psig B->A 609 Psig
Ambient temperature		-30 - 70 °C	-22 - 158 °F
Ambient relative humidity		Max. 95 % RH	Max. 95 % RH
Fluid temperature range		-30 - 70 °C	-22 - 158 °F

⁽¹⁾ A = Valve inlet
B = Valve outlet

Environmental conditions

Table 4: Environmental conditions

Environmental conditions		Value
Max. Internal leakage @10 bar, A-> B and B->A ⁽¹⁾	ETS 5M 13 - 24	< 150 cm ³ /min
	ETS 5M 25 - 40	< 500 cm ³ /min
Mechanical noise		< 60 dB(A)
Enclosure rating IP (Valve and coil combined)		IP 65
Insulation class		B
Insulation resistance		>100 MΩ
Storage temperature range [°C]		-30 - 70 °C / -22 - 158 °F
Relative humidity		Max. 95 % RH

⁽¹⁾ A = Valve inlet
B = Valve outlet

Flow characteristics

Air flow characteristics are provided for ETS 5M with normal and reverse flows.

Electric expansion valve, Type ETS 5M

Figure 3: Normal flow A -> B

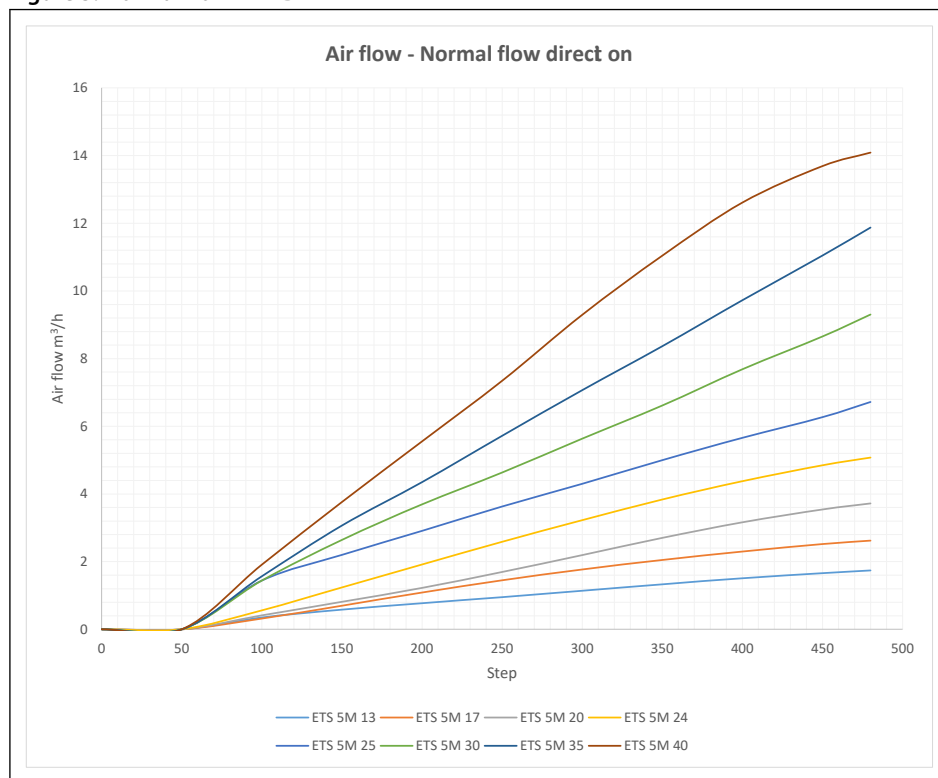
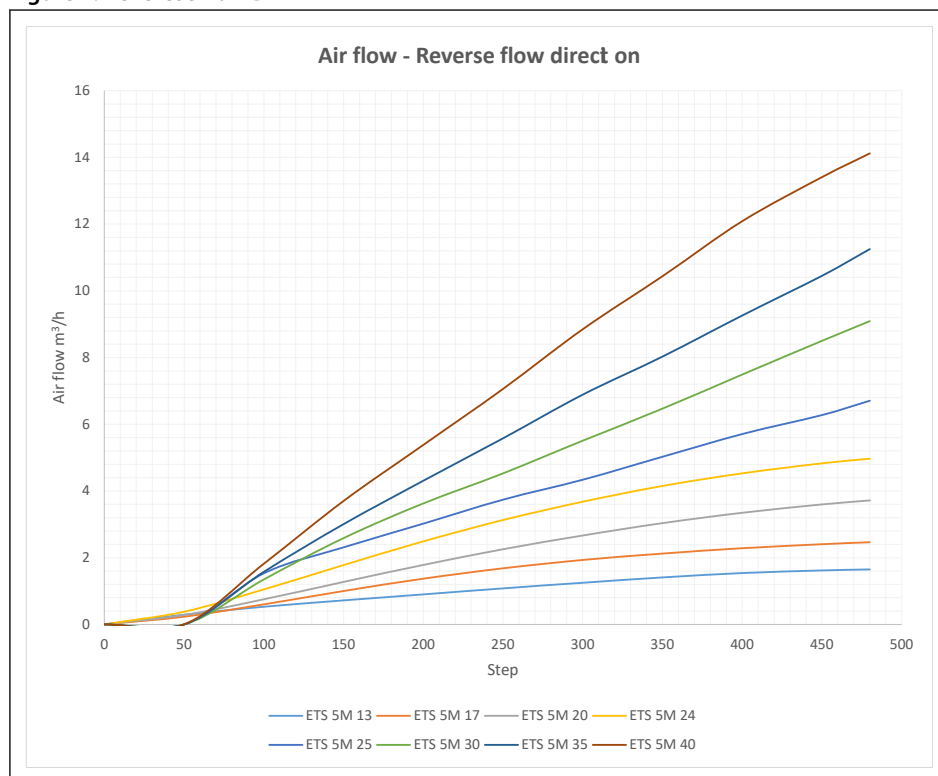

Figure 4: Reverse flow B -> A



Flow characteristics

- Measured at 1 barg differential pressure.
- Air flow provided in m³/hour (Y axis).
- Valve position provided by pulses in half steps (X axis).

Mechanical configuration options

ETS 5M is an angleway valve designed with a valve body in steel and ODM or ODF solder connections in stainless steel with copper plating, with inlet and outlet sizes 1/4 in, 5/16 in or 1/2 in.

Figure 5: ETS SM inlet and outlet configuration

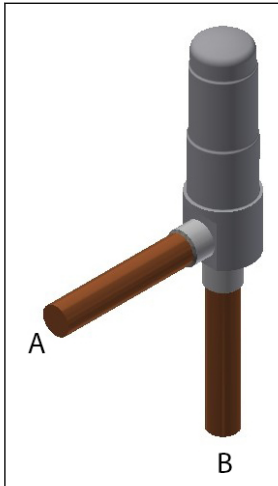

A	Inlet
B	Outlet

The copper connections are highly configurable and can be produced with the following shapes.

Table 5: Connection configuration

Shape L		Shape h		Shape h		Shape u	
1/4 in	5/16 in	1/2 in	1/4 in	5/16 in	1/4 in		
ODM	ODM	ODM	ODM	ODM	ODF		

NOTE:

Not all combinations of sizes and configurations are available. The table shows currently available configurations

Table 6: Mechanical configuration options

L Shape	ODF with straight connectors
L Shape	ODM with straight connectors
h Shape	ODF with elbow inlet and straight outlet
h Shape	ODM with elbow inlet and straight outlet
u Shape	ODF with straight inlet and elbow outlet
u Shape	ODM with straight inlet and elbow outlet

Electrical connection

Electrical connection is via a fixed cable in a number of lengths from the coil to the controller. Cables up to 2.7 m length are available with a JST XHP-5 / JST-XHP6 connector. See ETS 5M coil [Ordering](#) for details.

Electrical and motor specifications

Valve operation is by means of a uni-polar motor, designed as a separate coil that clicks onto the valve body.

Electric expansion valve, Type ETS 5M

Table 7: Electrical and motor specifications

Electrical and motor specifications	Value
Motor type	Uni-polar coil
Nominal voltage	12 V +10% / -15%
Coil resistance@ 20 °C	50 Ohm ± 10%
Rated current	0.24 A
Power consumption	4.1 W
Holding current after each sequence of steps	Min. 30 ms, max. 1 s
Permanent holding current	Not allowed
Recommended excitation method	1- 2
Possible, but not recommended excitation method	2- 2
Number of pulses	480 half-step pulse
Nominal pulse rate	31 pulses per second (PPS)
Maximum duty cycle (30s)	50 %
Insulation resistance	> 100 MΩ
Dielectric strength	< 5 mA

Stepper motor switch sequence

The stepper motor opens and closes as outlined in the table, opening moving down the table, closing moving the opposite direction.

Table 8: Stepper motor open and close sequence

	Yellow (A1)	Orange (A2)	Brown (B1)	Black (B2)	Red (Com)	
Valve opening ↓ ↓	ON	OFF	OFF	OFF	0	Valve closing ↑ ↑
	ON	OFF	ON	OFF	0	
	OFF	OFF	ON	OFF	0	
	OFF	ON	ON	OFF	0	
	OFF	ON	OFF	OFF	0	
	OFF	ON	OFF	ON	0	
	OFF	OFF	OFF	ON	0	
	ON	OFF	OFF	ON	0	

Dimensions (in mm)

Table 9: 1/4 inch male

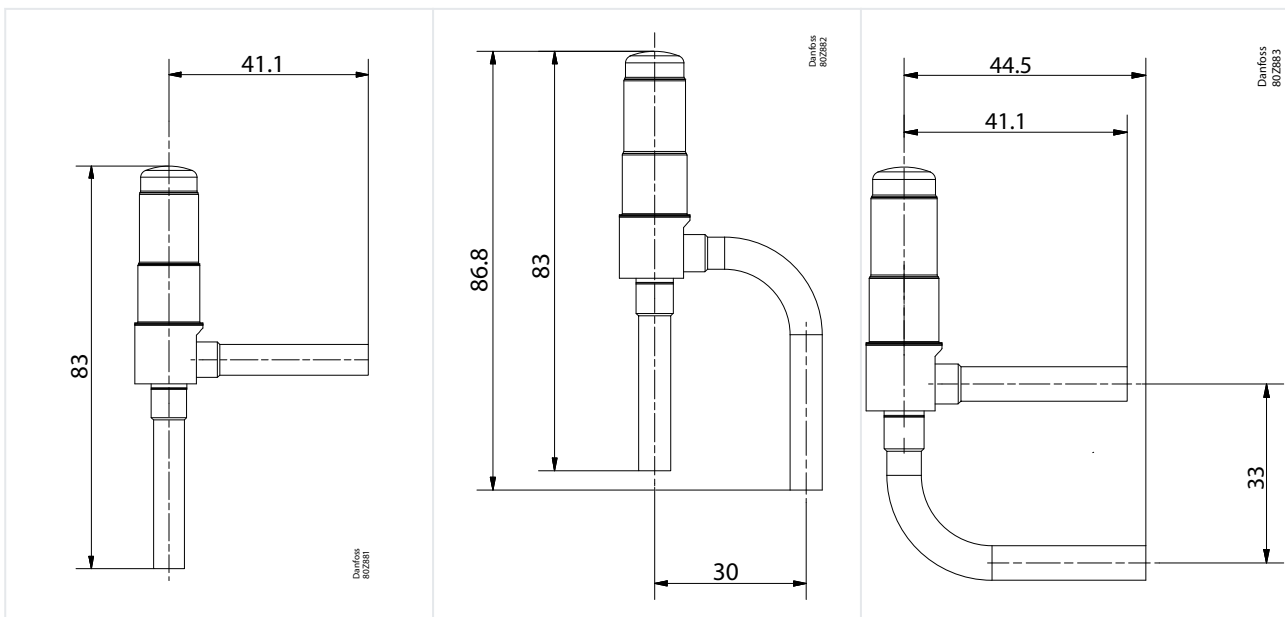

Electric expansion valve, Type ETS 5M

Table 10: 1/4 inch female

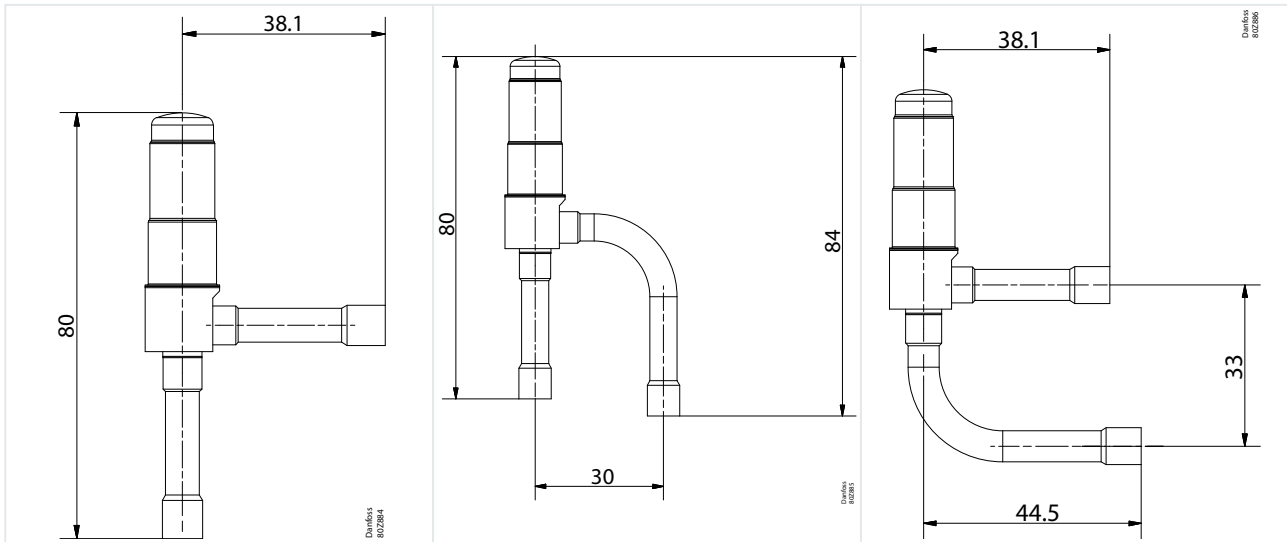

Table 11: 5/16 inch male

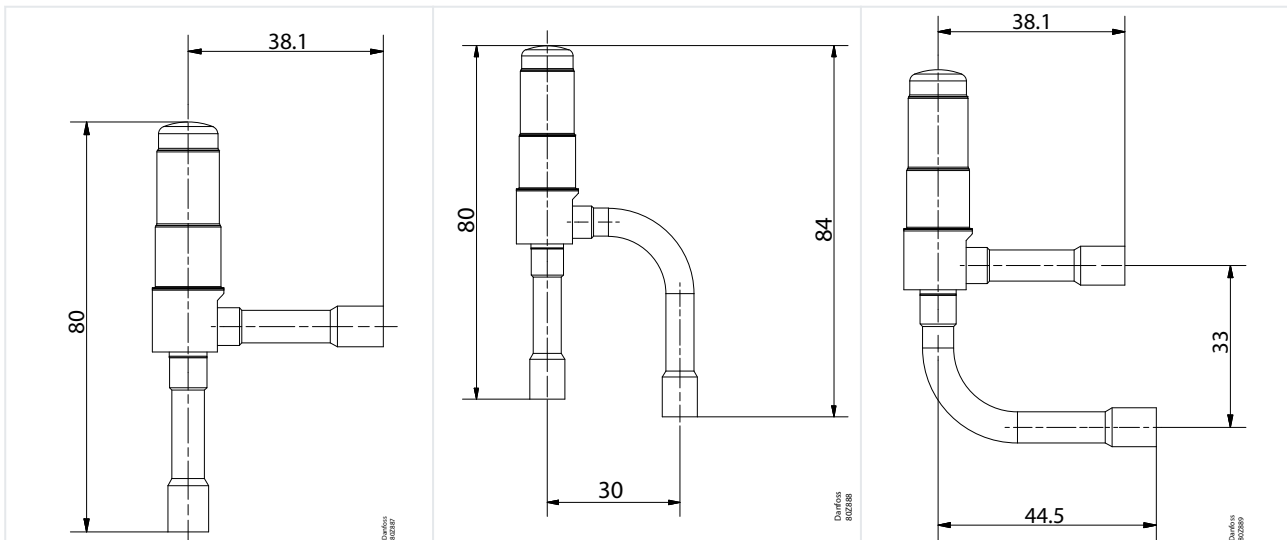

Figure 6: ETS 5M 25-40 5/16 inch male

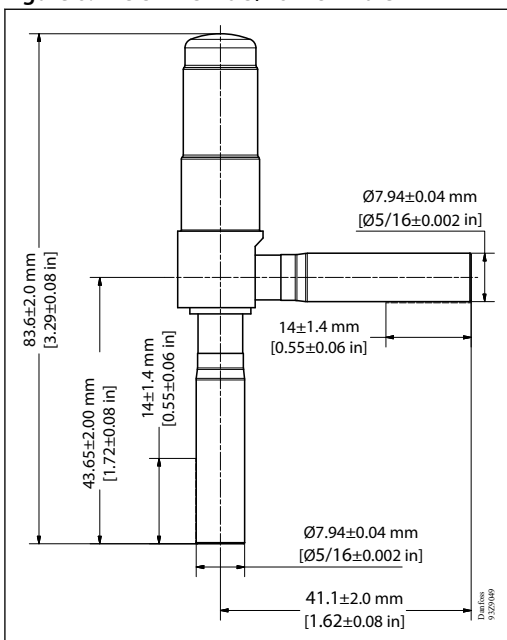
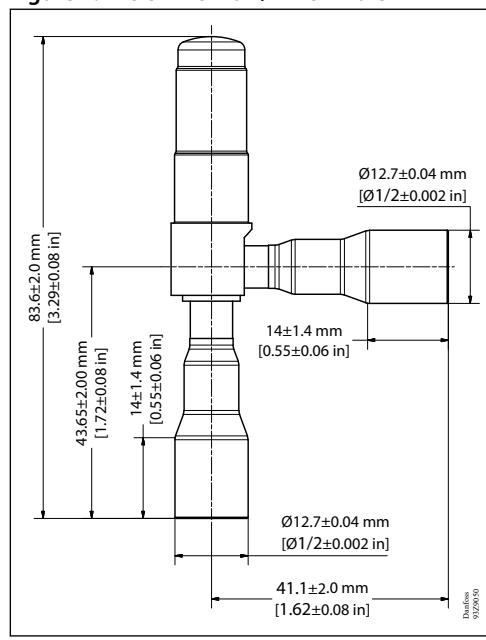
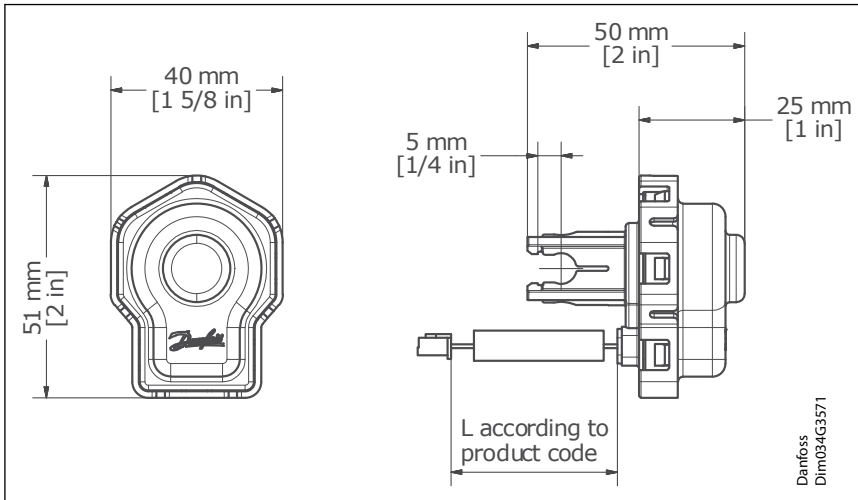

Figure 7: ETS 5M 25-40 1/2 inch male



Electric expansion valve, Type ETS 5M

Figure 8: ETS 5M coil dimensions



Ordering

Being highly configurable, ETS 5M can be delivered with a number of different mechanical connections according to requirements. This includes design configuration shape types L, h and u. See ordering details below.

Parts program

ETS 5M is a parts program consisting of a valve body and a separate uni-polar motor coil (ETS 5M coil). Each component is purchased separately.

Table 12: 5/16 inch male

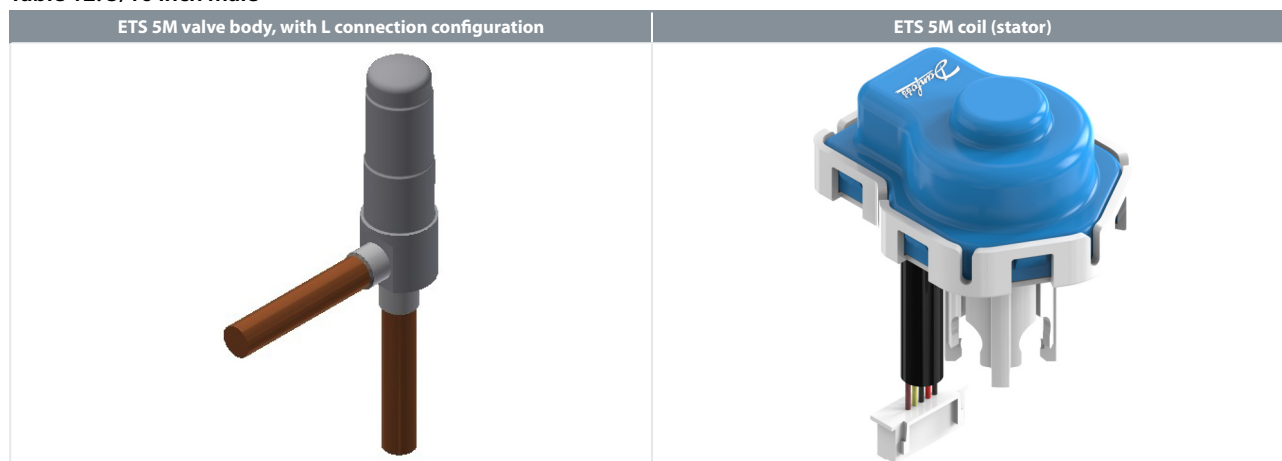

Besides using the ETS SM coil as spare part, ETS 5M valve is hermetic and cannot be taken apart, there are no other spare parts.

Valve body, standard code

Valve body ordering data

Table 13: ETS 5M valve body

Type	Design config. shape	Orifice size	Conn. type	Inlet x Out- let	Rated cap. R410A	Rated cap. R410A	Pack format	Qty/ pack	Code no
		[mm]		[in]	[kW]	[TR]			
ETS 5M13	L	1.3	Solder, ODM	1/4 x 1/4	8.9	2.52	Multi-pack	20 pc	034G6204
ETS 5M17	L	1.65	Solder, ODM	1/4 x 1/4	12.5	3.54	Multi-pack	20 pc	034G6207
ETS 5M20	L	2.0	Solder, ODM	1/4 x 1/4	16.7	4.74	Multi-pack	20 pc	034G6209
ETS 5M20	L	2.0	Solder, ODM	5/16 x 5/16	16.7	4.74	Industrial pack	40 pc	034G6210
ETS 5M20	L	2.0	Solder, ODM	5/16 x 5/16	16.7	4.74	Multi-pack	20 pc	034G6211
ETS 5M24	L	2.4	Solder, ODM	1/4 x 1/4	20.6	5.84	Multi-pack	20 pc	034G6212
ETS 5M13	u	1.3	Solder, ODF	1/4 x 1/4	8.9	2.52	Industrial pack	40 pc	034G6205
ETS 5M13	u	1.3	Solder, ODF	1/4 x 1/4	8.9	2.52	Multi pack	20 pc	034G6206
ETS 5M17	h	1.65	Solder, ODM	1/4 x 1/4	12.5	3.54	Multi pack	20 pc	034G6208
ETS 5M20	h	2.0	Solder, ODM	1/4 x 1/4	16.7	4.74	Multi pack	20 pc	034G6202
ETS 5M24	h	2.4	Solder, ODM	1/4 x 1/4	20.6	5.84	Multi pack	20 pc	034G6203
ETS 5M24	h	2.4	Solder, ODM	5/16 x 5/16	20.6	5.84	Multi pack	20 pc	034G6213
ETS 5M25	L	2.5	Solder, ODM	5/16 x 5/16	23.5	6.68	Multi pack	20 pc	034G6600
ETS 5M25	L	2.5	Solder, ODM	1/2 x 1/2	23.5	6.68	Multi pack	20 pc	034G6601
ETS 5M30	L	3.0	Solder, ODM	5/16 x 5/16	32.5	9.24	Multi pack	20 pc	034G6602
ETS 5M30	L	3.0	Solder, ODM	1/2 x 1/2	32.5	9.24	Multi pack	20 pc	034G6603
ETS 5M35	L	3.5	Solder, ODM	5/16 x 5/16	36.0	10.24	Multi pack	20 pc	034G6604
ETS 5M35	L	3.5	Solder, ODM	1/2 x 1/2	36.0	10.24	Multi pack	20 pc	034G6605
ETS 5M40	L	4.0	Solder, ODM	5/16 x 5/16	41.0	11.66	Multi pack	20 pc	034G6606
ETS 5M40	L	4.0	Solder, ODM	1/2 x 1/2	41.0	11.66	Multi pack	20 pc	034G6607

Electric expansion valve, Type ETS 5M

NOTE:

The rated capacity is based on :

- Refrigerant: R410A
- Evaporating temperature: $T_e = 5\text{ °C}$
- Condensing temperature: $T_c = 38\text{ °C}$
- Refrigerant temperature ahead of valve:
 - $T_{\text{liquid}} = 34\text{ °C}$
 - Subcooling = 4K
 - Superheat = 0K
 - Driving steps = 480steps



Valve sizing using calculation software

It is strongly recommended to use Coolselector®2 to find the correct valve for your application. The software can be downloaded from the Danfoss website. You can download it from [http:// coolselector.danfoss.com](http://coolselector.danfoss.com)

ETS 5M coil

Coils for ETS 5M are dedicated for the product.

Table 14: Coils for ETS 5M

Type	Cable length	Cable length	Electrical connector	Pack format	Qty/pack	Cade no.
	[m]	[in]				
ETS 5M	0.70 m	27.55	JST XHP-5	Industrial pack	40 pc	034G3805
ETS 5M	0.70 m	27.55	JST XHP-5	Multi pack	20 pc	034G3806
ETS 5M	1.00 m	39.37	JST XHP-6	Multi pack	20 pc	034G3804
ETS 5M	1.50 m	59.06	JST XHP-5	Multi pack	20 pc	034G3801
ETS 5M	2.70 m	106.30	JST XHP-5	Multi pack	20 pc	034G3802
ETS 5M	2.70 m	106.30	JST XHP-5	Industrial pack	24 pc	034G3807
ETS 5M	2.70 m	106.30	JST XHP-6	Multi pack	20 pc	034G3808

Accessories

Tools for servicing of ETS 5M

Table 15: Accessories for ETS 5M

Image	Accessory	Description	Code no.
	AST-G service driver	Driver for service of the valve	034G0013

Product identification

Valve body identification

Relevant product data is available on the box label and product label. On the product, information is laser engraved in 4 different fields on the steel valve body (not shown).

Electric expansion valve, Type ETS 5M

Figure 9: Box label, ETS 5M valve body



Table 16: Valve body, ETS 5M

Position	Inscription	Explanation
Box label	Electric exp. valve	Product title
Box label; Valve body	034G6204	Code no.
Box label; Valve body	12345N1219A	Internal production code denoting time of production
Valve body	ETS 5M	Product title
Box label; Valve body	ETS 5M17	Type and size
Box label	(Symbol drawing)	Configuration of code no.

ETS 5M Coil identification

Relevant product data is available on the box label and product label.

Figure 10: Box label



Figure 11: Product label

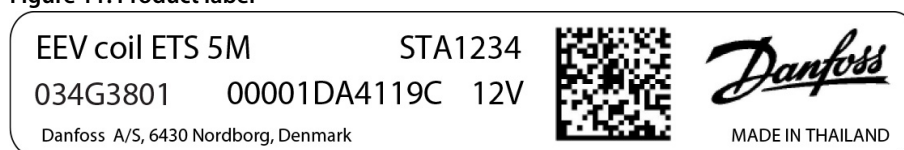

Table 17: Product label, ETS 5M coil

Position	Inscription	Explanation
Product label	EEV coil ETS 5M	Product title and Type
Box label	Coil for elec. exp. valve ETS 5M	Product title and Type
Box label; Product label	STA 1234	Internal production code denoting time of production
Product label	034G6204	Code no.
Product label	00001DA4119C	Serial no.
Product label	12 V	Rated voltage
Box label	Rated voltage: 12 V	Rated voltage
Box label	Cable: 1.5m, JST XHP-5	Cable connection specifications
Product label	(Data matrix symbol)	Machine readable data matrix
Product label	Made in Thailand	Manufacturing site acc. to EN standards
Box label	(Symbol drawing)	Configuration of code no.

Certificates, declarations and approvals

The list contains all certificates, declarations, and approvals for this product type. Individual code number may have some or all of these approvals, and certain local approvals may not appear on the list.

Some approvals may change over time. You can check the most current status at danfoss.com or contact your local Danfoss representative if you have any questions.



Table 18: Certificates, declarations and approvals

File name	Document type	Document topic	Approval Authority
CQC21002287020	Electrical - safety certificates		CQC

Compliance

ETS 5M complies with:

Table 19: Compliance table ETS 5M

	Pressure Equipment Directive
RoHS	Restriction of Hazardous Substances
	Registration, Evaluation, Authorisation and Restriction of Chemicals
	CQC Approved

Online support

Danfoss offers a wide range of support along with our products, including digital product information, software, mobile apps, and expert guidance. See the possibilities below.

The Danfoss Product Store



The Danfoss Product Store is your one-stop shop for everything product related—no matter where you are in the world or what area of the cooling industry you work in. Get quick access to essential information like product specs, code numbers, technical documentation, certifications, accessories, and more.

Start browsing at store.danfoss.com.

Find technical documentation



Find the technical documentation you need to get your project up and running. Get direct access to our official collection of data sheets, certificates and declarations, manuals and guides, 3D models and drawings, case stories, brochures, and much more.

Start searching now at www.danfoss.com/en/service-and-support/documentation.

Danfoss Learning



Danfoss Learning is a free online learning platform. It features courses and materials specifically designed to help engineers, installers, service technicians, and wholesalers better understand the products, applications, industry topics, and trends that will help you do your job better.

Create your Danfoss Learning account for free at www.danfoss.com/en/service-and-support/learning.

Get local information and support



Local Danfoss websites are the main sources for help and information about our company and products. Find product availability, get the latest regional news, or connect with a nearby expert—all in your own language.

Find your local Danfoss website here: www.danfoss.com/en/choose-region.

Spare Parts



Get access to the Danfoss spare parts and service kit catalog right from your smartphone. The app contains a wide range of components for air conditioning and refrigeration applications, such as valves, strainers, pressure switches, and sensors.

Download the Spare Parts app for free at www.danfoss.com/en/service-and-support/downloads.

Danfoss A/S

Climate Solutions • danfoss.com • +45 7488 2222

Any information, including, but not limited to information on selection of product, its application or use, product design, weight, dimensions, capacity or any other technical data in product manuals, catalogues descriptions, advertisements, etc. and whether made available in writing, orally, electronically, online or via download, shall be considered informative, and is only binding if and to the extent, explicit reference is made in a quotation or order confirmation. Danfoss cannot accept any responsibility for possible errors in catalogues, brochures, videos and other material. Danfoss reserves the right to alter its products without notice. This also applies to products ordered but not delivered provided that such alterations can be made without changes to form, fit or function of the product.

All trademarks in this material are property of Danfoss A/S or Danfoss group companies. Danfoss and the Danfoss logo are trademarks of Danfoss A/S. All rights reserved.