

Data Sheet

# Evaporator and room control Type **EKE 400**

For industrial refrigeration applications



The EKE 400 controller is a dedicated controller for evaporators typically used in industrial refrigeration applications. EKE 400 will be able to manage the complete operation in cooling and defrost mode.

### Features

- Approved and qualified by Danfoss for refrigeration applications
- One product covering multiple valve configurations
- HMI includes wizard for easy setup
- Multiple EKE 400 can be interconnected for signal sharing via integrated CANBUS. (defrost coordination<sup>(1)</sup>, temperature sharing etc.)
- Easy to connect to third party equipment like PLC via integrated MODBUS
- EKE 400 can be connected to AK-SM 800 series
- EKE 400 is available without HMI to save cost
- One remote HMI can interface multiple EKE 400
- One EKE 400 cover both 24 V AC and 24 V DC
- One EKE 400 cover wide voltage and frequency range; 85 – 265 V AC, 50/60 Hz
- Flexible Analog input. Cover both Pt-1000/NTC temperature sensor and 4 – 20 mA / 1 – 5 V Pressure transmitter
- 2 Digital output out of 8 Digital output is solid state for PWM<sup>(2)</sup> (puls) valves
- EKE 400 with HMI includes multilanguage support (English, Chinese, Portuguese, Spanish)
- International units supported. Metric and Imperial
- HMI will during setup, filter out irrelevant parameters or conversely, show parameters that are relevant based on earlier selection

**\*CoolConfig configuration software tool supports EKE 400.**

See last page in this document. [CoolConfig](#)

---

<sup>1</sup> See [Appendix A](#)

<sup>2</sup> Pulse Width Modulating valves like Danfoss type AKV or AKVA.

## Application

Figure 1: EKE 400 without/with HMI



For industrial refrigeration applications the Danfoss EKE 400 can control the operation of the valves and the fans for evaporators to achieve optimal cooling mode and defrost sequence for an efficient, safe and trouble-free operation of the evaporators, complying with IIR<sup>(3)</sup> safety recommendations for hot gas defrost.

This means:

- Controls operation of the valves and the fans for each evaporator
- Controlling and optimizing defrost sequence and performance
- Applicable for defrosting flooded evaporators, including Ammonia and CO<sub>2</sub>
- Supports various defrost methods: Hot gas defrost by pressure control or liquid drain, water/brine defrost, and electrical defrost.
- EKE 400 is using industry terminology in both the HMI<sup>(4)</sup> interface and associated literature (wet return line, liquid feed line etc.)

EKE 400 is available both with and without HMI. The HMI contains a graphical display and a six push button to operate and navigate through the menu system. A menu wizard will guide the user through basic configuration questions. Based on parameter selections, irrelevant parameters will be filtered out and minimize time at commissioning the EKE 400

As EKE 400 is a dedicated controller for industrial refrigeration it will have full support of Danfoss industrial refrigeration valves<sup>(5)</sup>:

- ICF valve station
- ICM motorized valve <sup>(6)</sup>
- ICS servo valve with constant pressure control pilots like CVP
- OFV overflow valve
- ICLX 2-step gas powered solenoid valve
- ICSH dual position solenoid valve
- ICFD Defrost module
- Various solenoid valves; EVRA, EVRAT, EVRS, EVRST, ICS with EVM, ICF with ICFE

## Product function features

### Product function features

*Examples of applications supported by EKE 400:*

- Flooded ammonia/CO<sub>2</sub>/HCFC/HFC
- Direct expansion (DX) ammonia/CO<sub>2</sub>/ HCFC/HFC
- Superheat Control by
  - Fixed Superheat reference
  - Load defined reference (LoadAP)
  - Minimum Stable Superheat (MSS)

<sup>3</sup> International Institute of Ammonia Refrigeration

<sup>4</sup> Human Machine Interface (HMI) is the interface between the EKE 400 controller and the user.

<sup>5</sup> Competitors valves may be used with EKE 400.

<sup>6</sup> EKE 400 can support: ETS 6, ETS, KVS, ETS Colibri®, KVS Colibri®, CTR, CCMT valves. See [Appendix B](#)

## Evaporator and room control, type EKE 400

---

- Modulating Thermostat (MTR) or simple ON/OFF
- Media temperature control of suction line valve with motorized valve (Danfoss type ICM/ICAD or similar)
- Media temperature control of suction line valve with servo valve (Danfoss type ICS/CVE/ICAD or similar)
- Pressure control of suction line valve with motorized valve (Danfoss type ICM/ICAD or similar)
- Pressure control of suction line valve with servo valve (Danfoss type ICS/CVE/ICAD or similar)
- Modulating Thermostat (MTR) by modulating the valve (Danfoss type AKV/AKVA) or similar in the liquid line
- Defrost
- Support of Multiple Defrost methods
  - Hot Gas defrost by pressure
  - Hot Gas defrost by liquid drain
  - Defrost by water or brine
  - Individual defrost schedules by single weekdays, Saturdays and Sundays
- Defrost start
  - Defrost start by PLC via MODBUS or Digital Input
  - Defrost start by time interval (time since last defrost start)
  - Defrost start according to accumulated cooling time
  - Defrost start via defrost schedules and Real Time Clock (RTC)
  - Forced manual defrost via HMI or by PLC via MODBUS
- Defrost stop
  - Defrost stop on time duration
  - Defrost stop on temperature
- Separate Drip tray control (separate from main Hot Gas valve)
- Emergency cooling - failsafe operation
- Safe startup after power failure
- Product temperature alarm option

Figure 2: Flowchart

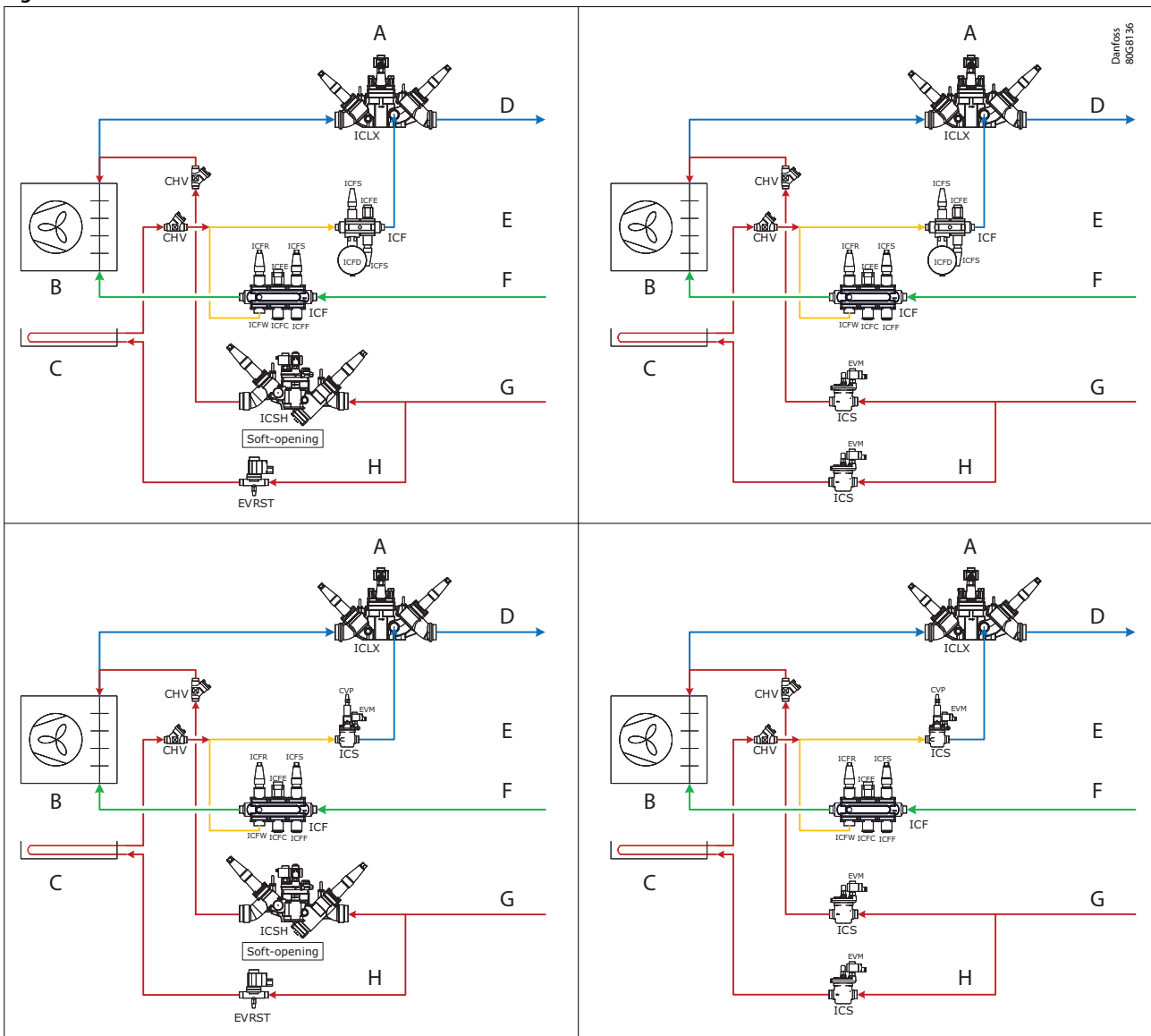

Danfoss  
80CG8136

<b>A</b>	Soft opening	<b>D</b>	Wet return line	<b>G</b>	Hot gas defrost line
<b>B</b>	Evaporator	<b>E</b>	Defrost drain line	<b>H</b>	Drip tray line
<b>C</b>	Drip tray	<b>F</b>	Liquid feed line		

## DX and Hot gas defrost

### DX and Hot gas defrost

EKE 400 offers the possibility to control DX applications and combine with Hot gas defrost across all the possible valves available. E.g. EKE 400 can support DX and CO<sub>2</sub>, combined with Hot gas defrost with ICF valve stations.

Figure 3: Application sketch

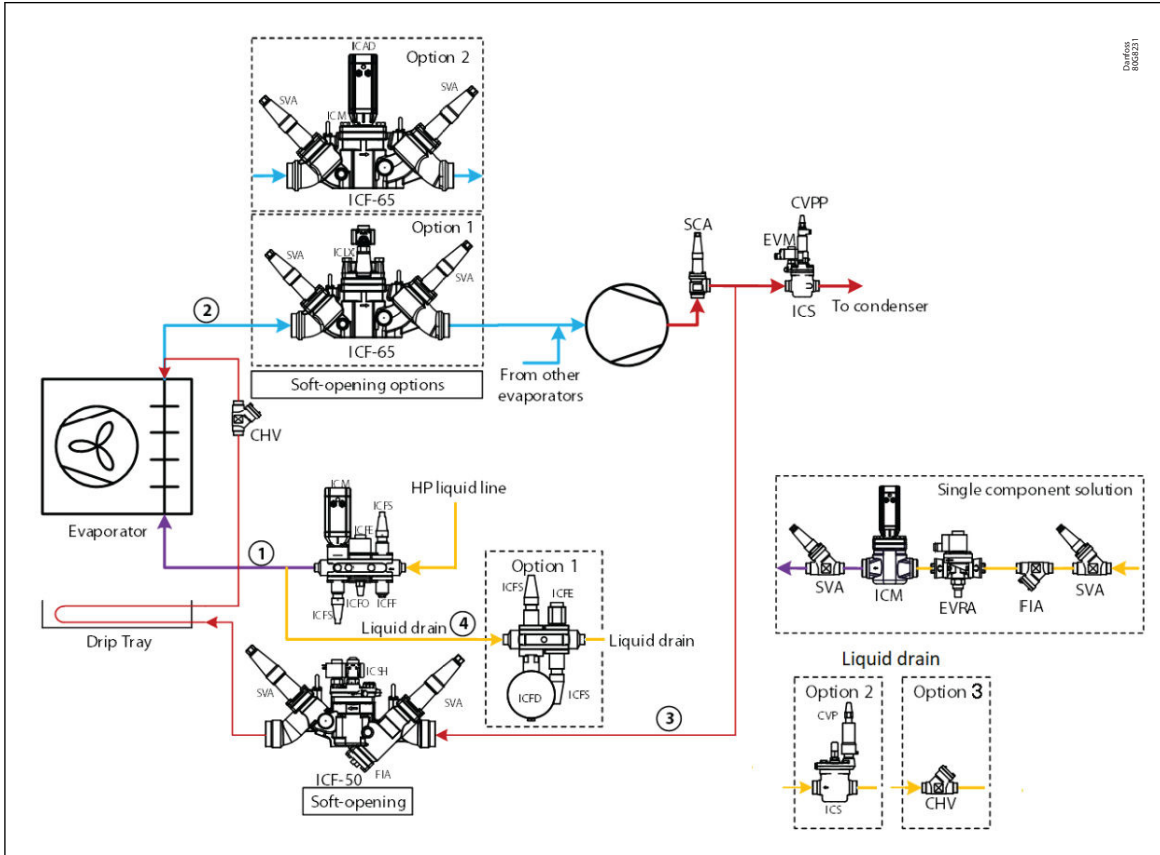

## MTR (Modulating Thermostat) in Liquid Line Flooded systems

### MTR (Modulating Thermostat) in Liquid Line Flooded systems

As for DX systems, EKE 400 has an adapted function of MTR also for flooded systems. Selecting this function, EKE 400 will be able to control the room temperature much more accurate than a traditional ON/OFF temperature control. EKE 400 will also equalize the load on the system to get better operating conditions. MTR requires PWM (Pulse Width Modulating) valves like Danfoss type AKV or AKVA in the liquid line. Typical industrial applications with the refrigerant Ammonia or CO<sub>2</sub> is in scope.

Figure 4: MTR in Liquid line flooded systems

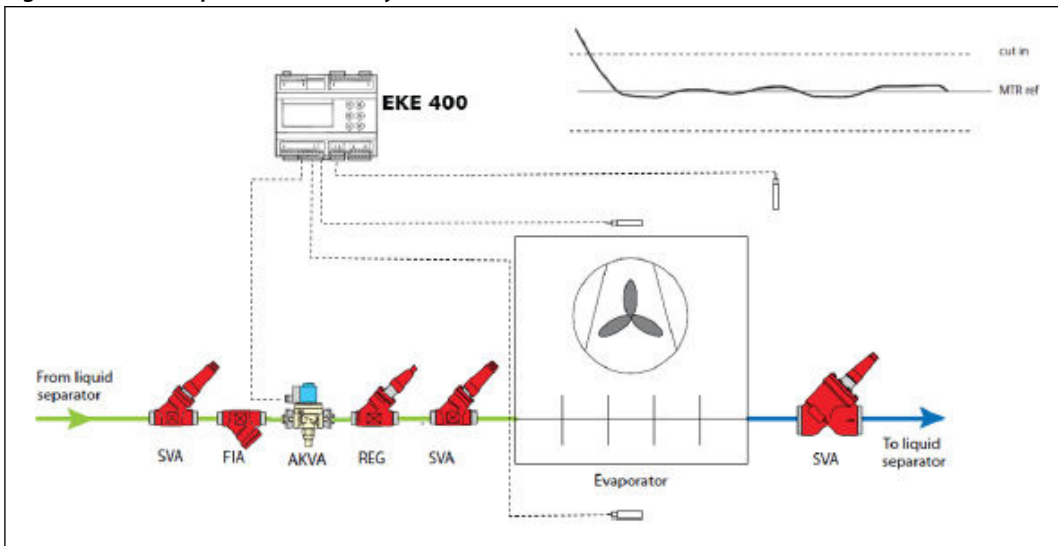

## Media temperature and pressure control - suction line

Media temperature and pressure control - suction line <sup>(7)</sup>

EKE 400 will be able to control valves in the wet suction return line. The control mode can be either temperature or pressure. Support of Danfoss Industrial Refrigeration Valves like ICM with ICAD and ICS/CVE/ICAD can be combined with multiple defrost methods, including Hot Gas.

Figure 5: Media temperature and pressure control - suction line

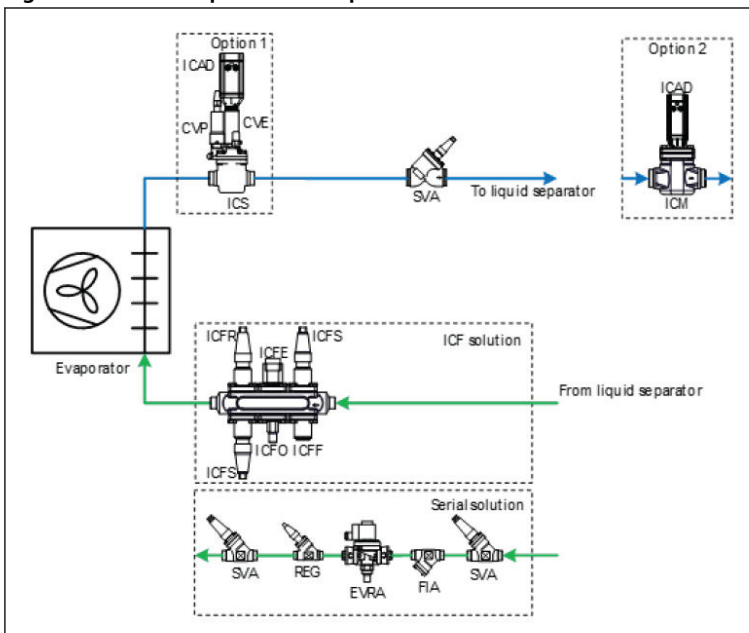

<sup>7</sup> Same basic media temperature functions as in EKC 361, but with updated and optimized algorithm. See [Appendix C](#)

**Product specification**

**Basic operation**

**Basic operation:** Configuration and daily operation of EKE 400 is done via the built-in HMI or via a remote connected HMI. The display supports multiple languages and engineering units.

**Status screens:** Get an overview of how the system is running in the status screens. Use the LEFT / RIGHT buttons to view the status screens.

Figure 6: Status screen

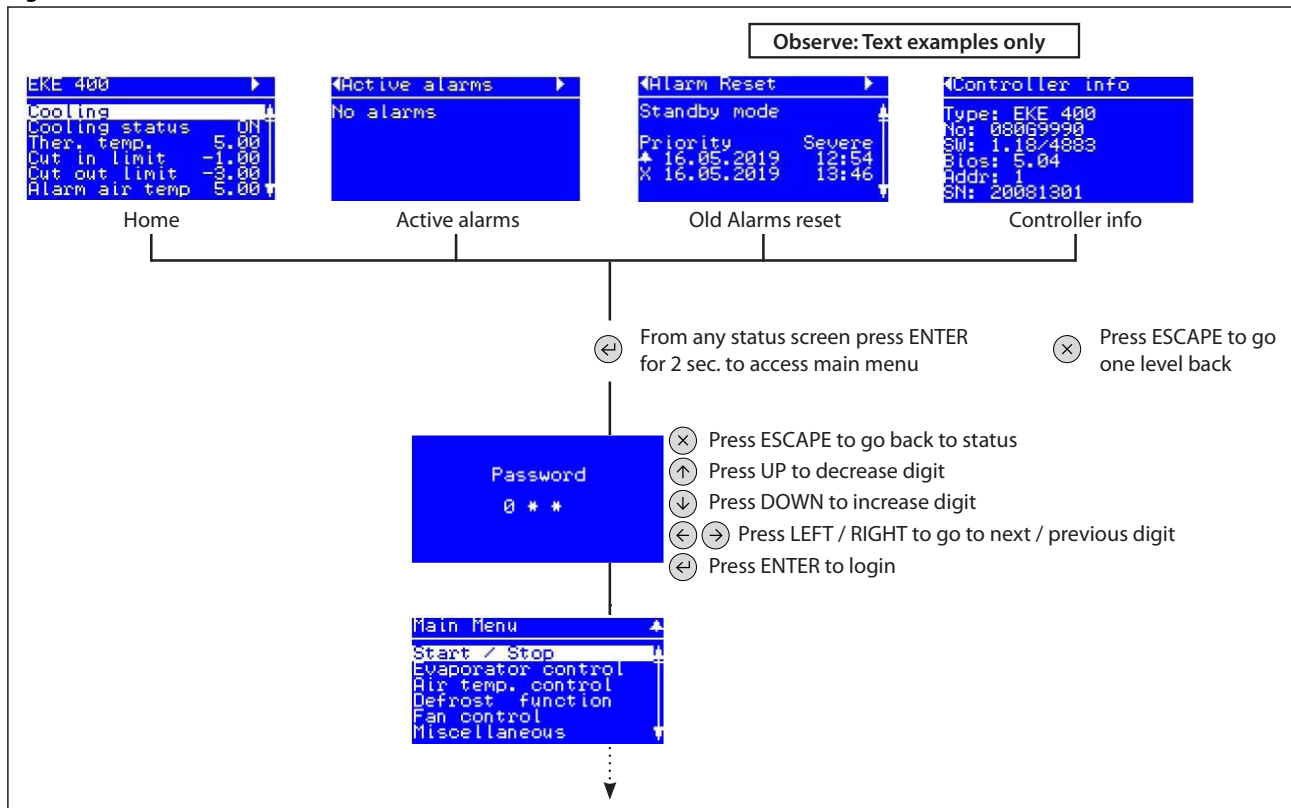

**Password**

See EKE 400 Wizard, Parameterlist, for further details further details on Password levels and user rights

Table 1: Password level

Parameter	Password level	Functions
	Password level 0	Level 0 will only allow to see the screens: "Status screen 1", "Active alarms", "Alarm Reset" and "Controller info"
G07	Password level 1	Level 1 will give access to see all parameters and sub menus, but no settings can be changed.
G08	Password level 2	Enter password for level 2 access. Level 1 will give access to see all parameters and sub menus. Some settings can be changed.
G09	Password level 3	Enter password for level 3 access. Level 1 will give access to see all parameters and sub menus. All settings can be changed.

**Configuration**

If the I/O configuration can not be met, after the Wizard is completed, a warning will be displayed

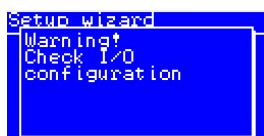

Go to IO configuration or IO status and go through Digital output/input and Analog output/input





Identify the IO with an exclamation mark "!" and reconfigure it.

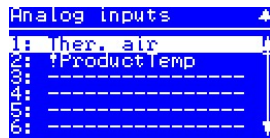

## Setup overview

There are two ways in which the controller can be set up:

### Wizard

- Here you will be led through a series of selected parameters that are commonly needed to be configured at every start up. This will also mean faster setup for many applications.
- Please observe, that some parameters not included in the Wizard may still need to be configured. This must then be done from the complete Parameter list

### Parameter list

- Here a complete list of all parameters can be found

### Operating principles:

1. Select position using arrow keys
2. Select using "Enter"
3. Use the "X" to return

Figure 7: EKE 400

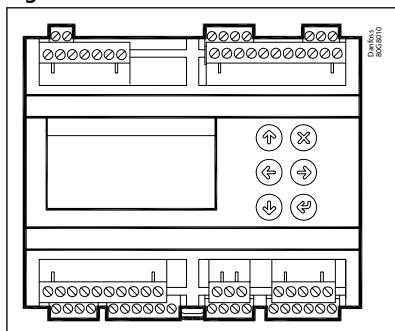
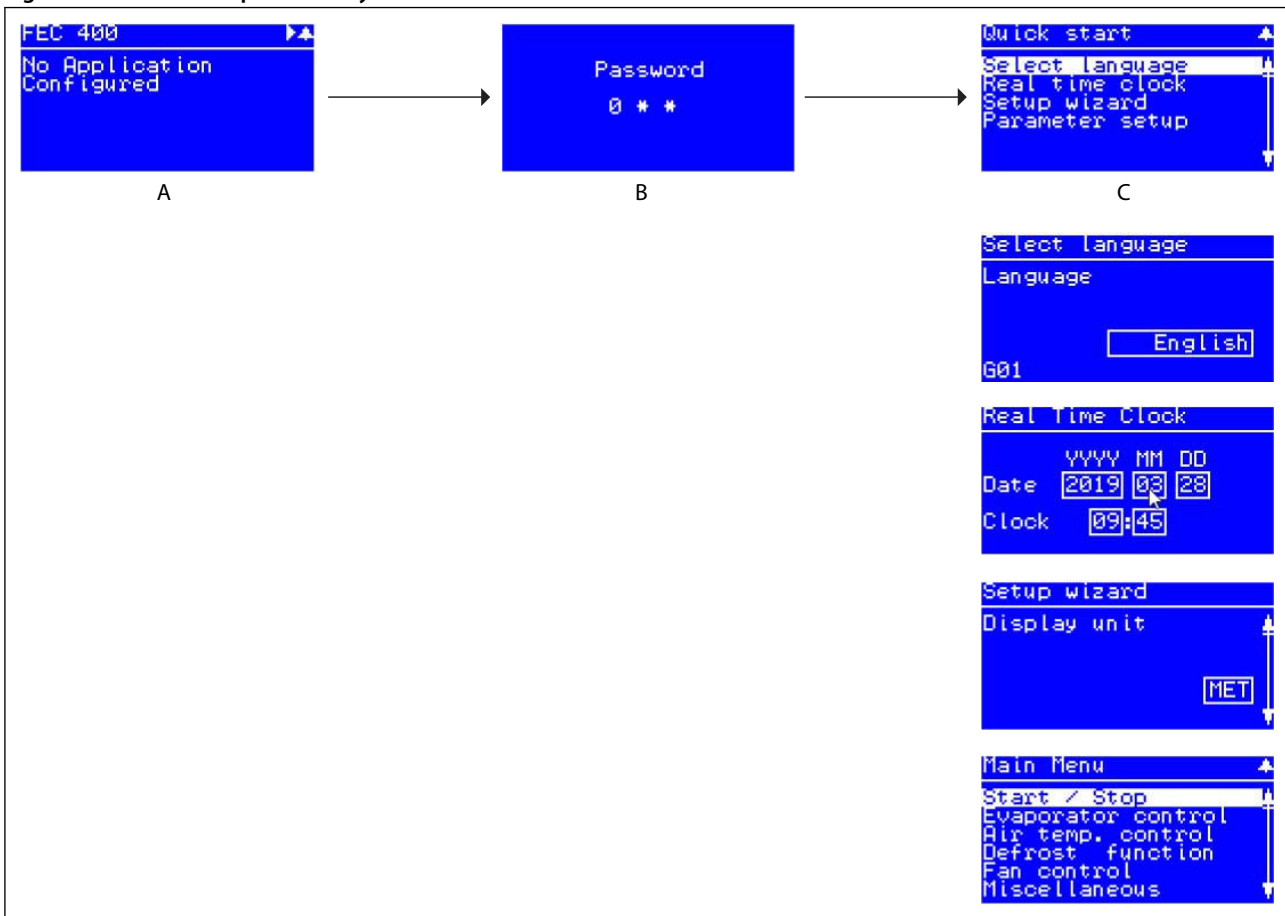

Figure 8: Start screen upon delivery



- A Hold "Enter" down for 2 seconds to come to password entry
- B The default password upon delivery is 300. Use the arrow keys to set the password. End by pressing "Enter"
- C Select a set-up method. End by pressing "Enter"

### Temperature control

Figure 9: Temperature control

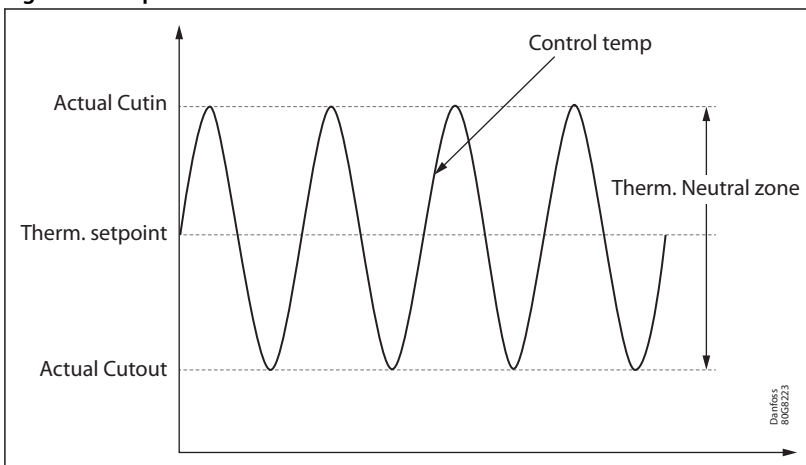

#### For ON/OFF thermostat and Flooded and DX application

One, two or three temperatures sensors, normally located in the cool room, can be connected to EKE 400. The number of sensors depends normally on the size of the room.

## Evaporator and room control, type EKE 400

If more than one temperature sensor have been selected, then the thermostat function can be selected to control temperature from the average or the highest temperature from the temperature sensors.

A Temperature setpoint (T04) and a Neutral zone(T05) are entered in EKE 400. Neutral zone divided by 2 will give Cut-in and Cut-out temperature of the thermostat, normally the liquid line valve ON/OFF.

### Modulating thermostat (MTR)

DX only

**Observe:** The MTR function must not be enabled in a system containing only 1 evaporator

Modulating thermostat (MTR regulation maintains a more constant temperature and also equalize the load on the system to get better operating conditions:

- Each of the individual evaporator sections is controlled individually using a modulating thermostat function.
- A Temperature setpoint (T04) and a Neutral zone(T05) must be set as with an ON/OFF thermostat.

MTR is modulating the cooling capacity to match the cooling demand.

In the pull-down phase then the temperature is well above the MTR set point cooling capacity is at maximum and superheat is controlled to be on superheat reference. When temperature is getting close to the MTR reference (typical 4 K) the cooling capacity gradually reduce so that the temperature can be stable on the MTR reference.

The MTR reference is defined by Temperature setpoint (T04).

Figure 10: Modulating thermostat

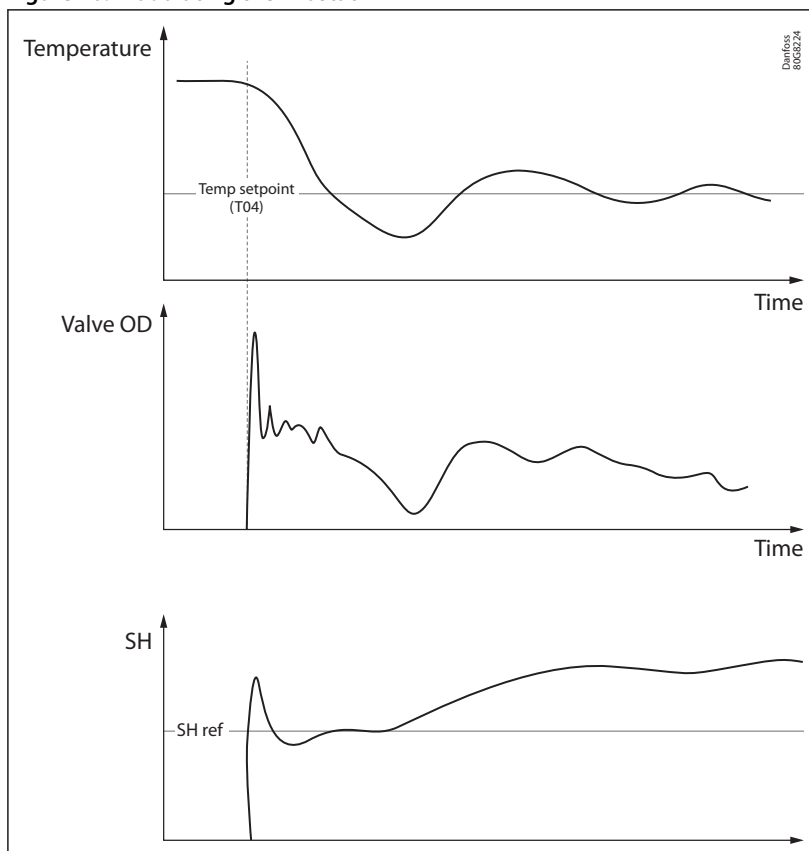

### Superheat reference calculation methods

In superheat mode the controller will control the superheat to be stable and closer to the superheat reference. This will give the optimal utilization of heat exchanger and thereby maximum cooling capacity. If superheat is too low, the flow in the expansion is decreased and superheat will be higher.

Figure 11: Actual superheat =  $S2 - T0$

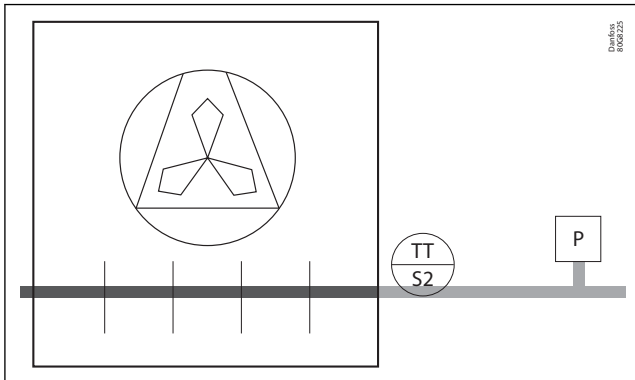

TT, S2	Pt1000 temperature sensor
P	Pressure transmitter

P can be displayed in [Bar] or [psi].

If a refrigerant has been entered in parameter "r20,Refrigerant" then the calculated evaporating temperature, converted from the pressure transmitter, is called T0 (or Te).

**Superheat reference can be calculated based on following 3 different methods:**

**MSS (Minimum Stable Superheat)**

The superheat control algorithm will attempt to regulate the superheat down to the lowest stable value between the minimum superheat setting, "Min SH" and the maximum superheat setting, "Max. SH".

**LoadAP Superheat**

LoadAP is an abbreviation of "load defined reference". LoadAP will adjust reference to be higher if load is higher. Load is indicated by the OD of valve. LoadAP is a kind of preprogrammed MSS curve. This method will give a robust SH reference and can in many cases be the best fit for systems.

**Fixed Superheat**

This feature is used in a system where a stable fixed superheat is required.

- MSS - Parameter N01, SH ref. mode is set to: Adaptive SH ctrl
- LoadAP - Parameter N01, SH ref. mode is set to: Load defined ctrl
- Fixed Superheat - Parameter N01, SH ref. mode is set to: Fixed SH ref.

Figure 12: Superheat reference

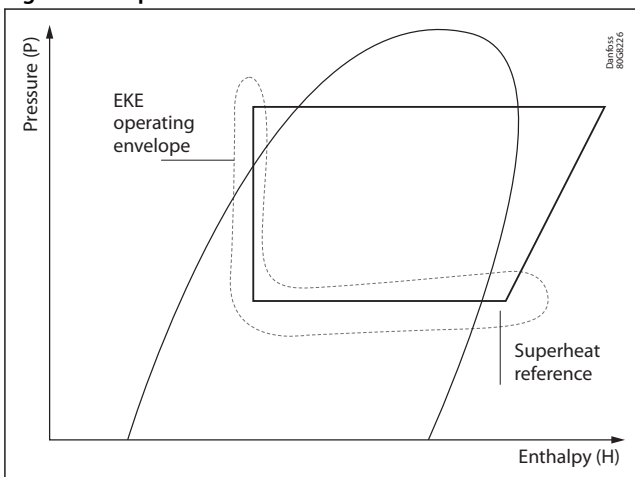
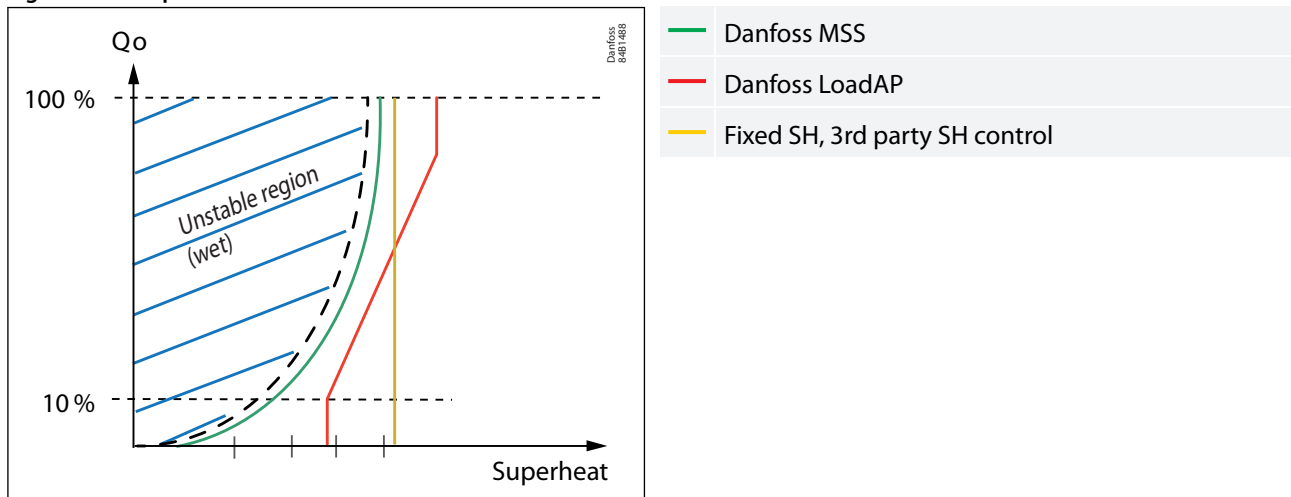

Figure 13: Comparison between SH reference



### MSS

The controller will search for the minimum stable superheat between an upper and lower boundary. If the superheat has been stable for a period, the superheat reference is decreased. If the superheat becomes unstable, the reference is raised again. This process continues as long as the superheat is within the bounds set by the user. The purpose of this is to search for the lowest possible superheat that can be obtained while still maintaining a stable system.

Figure 14: MSS

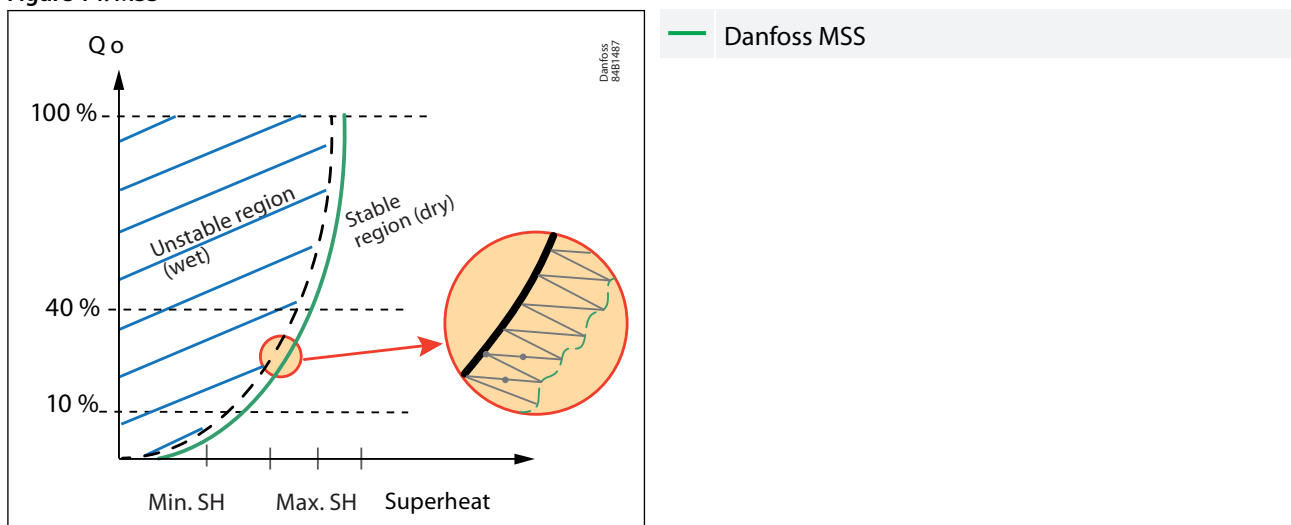

### MSS PI controller is made up of 3 parts:

- a stability set point
- the variant from the  $T_e$  signal
- actual superheat reference

The stability set point is given from the “user”. The variants from the  $T_0$  signal is used to allow for increased instability if the  $T_0$  signal is unstable. Finally the part from the actual superheat allows for more instability at higher superheat references than at lower references.

The superheat reference SH ref is adaptive and adjusted. When using this form of control, there are three settings that have major effect on this mode of control. These are Min. SH, Max. SH and SH close parameters.

**Where to use:**

MSS is a benefit for systems with a long runtime and slow changing conditions like cold rooms, display cases and chillers. Short cycling and system with fast changing operation condition will not benefit from MSS as this feature will take time to find the optimal reference. Adaption to a new set point is approx. 15 min.

**Table 2: Functions**

Parameter	Function	Description
R01	Evaporator control mode	2 = DX control
N01	SH reference mode	2 = Adaptive SH ctrl.
N03	SH max. value	Max. allowed SH reference
N04	SH min. value	Min. allowed SH reference Note: SH min. value must be >0.5K higher than SH close value, if N09 = 1
N18	MSS stability	Stability factor for regulation of superheat, only relevant for MSS. With a higher value the control function will allow a greater fluctuation of the superheat before the reference is changed.
N19	MSS T0 stability factor	Only relevant for MSS. T0 stability factor defines if variation in suction pressure will influence superheat reference. The SH reference change can be adjusted by setting the value 0 to 1 (1 = max T0 influence and S2, 0 = S2 only). With often change in suction pressure due to compressor start/stop, some T0 (and S2) influence on MSS is recommended.
N09	SH close function	0 = Off   1 = On, default = 1
N10	SH close setpoint	Default value = 2 K (recommended)

**Start up**

Sometimes in one to one applications. the valve does not open sufficiently on start-up and troublesome low-pressure trips happen. The following features allows the valve to open faster as well as to reach the optimal operating conditions quickly.

**Proportional (P) control N20, Startup Mode=0**

P-control function quickly stabilize the system's superheat by reaching optimal operating conditions in shorter period of time. The controller is programmed for auto proportional control that will quickly change the opening degree based on evaporating temperature and superheat of the system.

**Figure 15: SH reference**

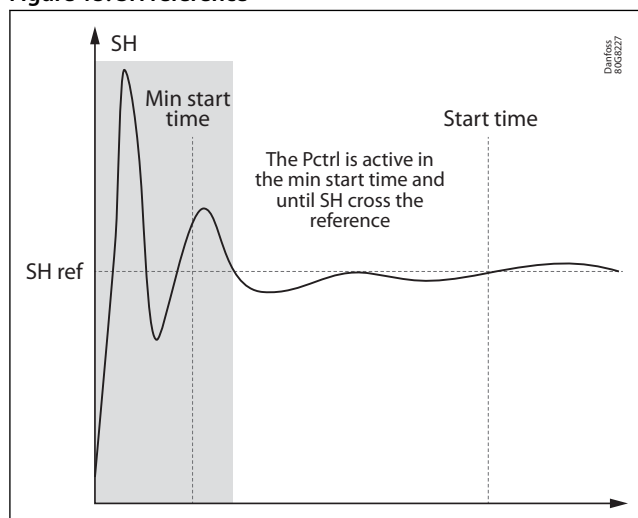

**Figure 16: SH reference**

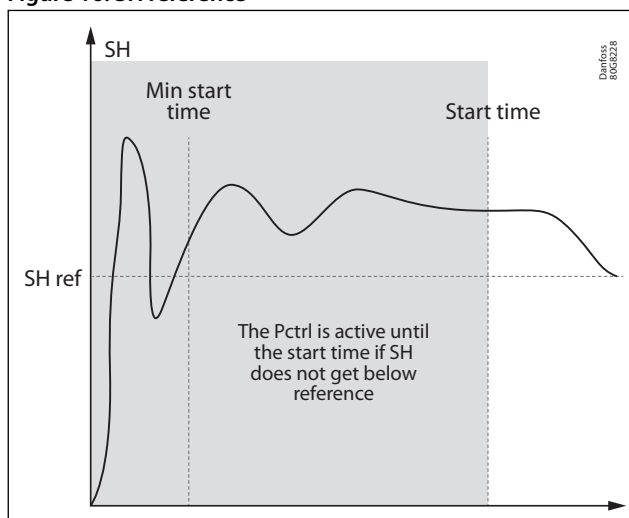

**Predefined OD with protection N20, Startup Mode=1**

After startup, this function will provide a start opening degree during a set time period. If the limiters, the valve will do the auto adjustment based on the operating conditions and the set limitations.

**Figure 17: Predefined OD with protection N20**

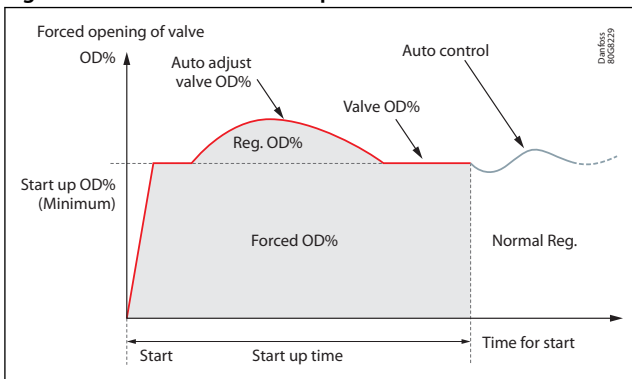

**NOTE:**

At start up, if the valve is opened too much, it could result in flow of liquid in the compressor or could trigger the HP switch which will stop the system. Whereas if you start the system with too low opening degree, it could also stop the system because of the low-pressure switch cut in. It will be safe to start the system with approximately 50% OD of the valve at start up, if P-control is not being used.

**Predefined OD without protection N20, Startup Mode=2**

After startup, this function will provide a constant opening degree during a set time period regardless of the superheat value. No limiters are taken in consideration during this time.

**Figure 18: Predefined OD without protection N20**

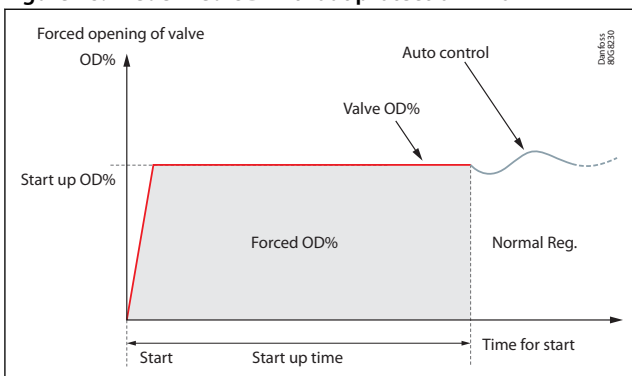

**DX with defrost by Hot Gas, and the Defrost Drain Line connected to the receiver**

In a DX application, with Hot Gas defrost and the Defrost Drain Line connected to the receiver, the EKE 400 can provide a function to manage the valve in the main Hot Gas line. See [Figure 19](#) and [Figure 20](#).

If the Defrost Drain Line is connected to the Liquid receiver it is possible to control the valve in the main HG line from EKE 400. The purpose of the valve in the main Hot Gas line (e.g. Danfoss type ICS with EVM (SI-port) and a CVPP (P-port)) is to build up pressure in the Hot Gas line to the receiver during defrost. I.e. once the EVM is energized then pressure is built up in the Hot Gas line to the receiver via the CVPP.

The EVM can be controlled from the EKE 400. See sketch below: The parameter: D08, Def. seq. status on DO, must be set to: Yes The assigned DO (DO1 to DO8) must be connected to the EVM on the ICS with CVPP in the main Hot Gas line.

Figure 19: Application sketch

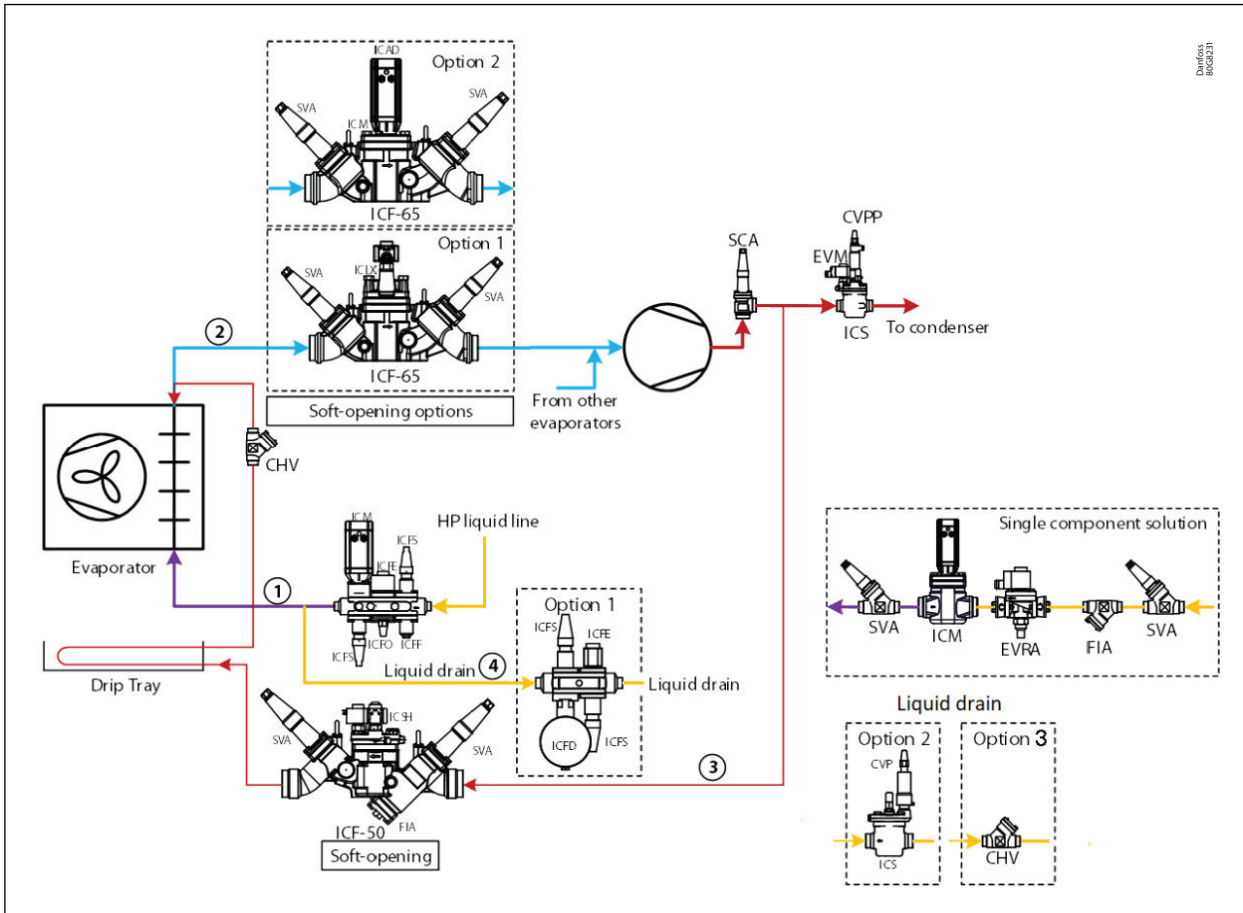

Danfoss  
8068231



Figure 20: Application sketch

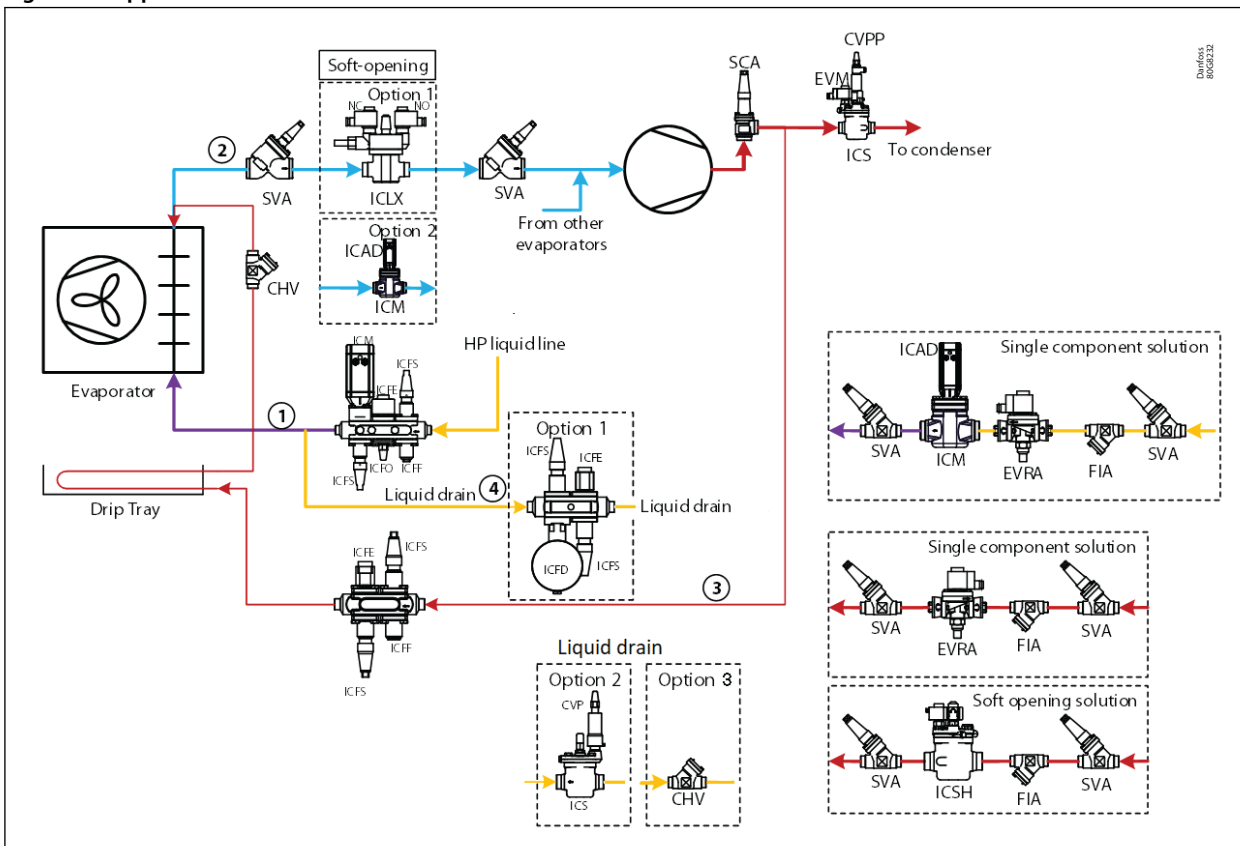

## EKE 400 Wizard

SW version 1.71 and higher

Table 3: EKE 400 Wizard

Label ID <sup>(1)</sup>	Parameter name	Description and selection options	Min.	Max.	Factory setting
QS	Select quick setting	<p><b>Select most common type of applications</b></p> <p>Selecting one of below application will then preselect valves the actual application in question. See Table 2</p> <p>1: Flooded On/Off: Flooded, Thermostat ON/FF with Hotgas Defrost by pressure or Liquid drain</p> <p>2: Dx On/Off: DX with Hotgas Defrost by pressure or Liquid drain</p> <p>3: Flooded Mod WR ctrl: Flooded, Wet Return line control (pressure) Defrost by pressure or Liquid drain</p> <p>5: PWM mod.flood: PWM Modulating Thermostat (MTR) in Liquid Line. Flooded systems</p> <p>6: EKC315A replace: Retrofit/upgrade from EKC 315A to EKE 400</p> <p>7: EKC361 replace: Retrofit/upgrade from EKC 361 to EKE 400</p> <p>0: User defined; Means that if none of the applications 1 to 7, match - then select User defined and continue to complete the wizard</p>	0	7	0
P01	Display unit	<p><b>Display unit</b></p> <p>0:MET: Metric units - Celsius (°C) and Kelvin (°K)</p> <p>1:IMP: Imperial units - Fahrenheit (°F) and Rankine (°R)</p>	0	1	0=MET
R01	Evap. ctrl mode	<p><b>Evaporator control mode:</b></p> <p>-1:None</p> <p>0:Flood. evap. On/Off</p> <p>2: DX control</p>	-1	2	0=Flood. evap. On/Off
T26	Evap.Pres.Control	<p><b>Evaporation pressure control</b></p> <p>0: No</p> <p>1: Yes</p>			0=No

## Evaporator and room control, type EKE 400

Label ID <sup>(1)</sup>	Parameter name	Description and selection options	Min.	Max.	Factory setting
D1A	Defrost method	<b>Select the defrost method</b>  0: No defrost: No defrost function 1: Hot gas: Defrost done by Hot gas 2:Electrical, water or air defrost (air defrost in rooms with temperature higher than 0 °C (32 °F))	0	2	1=Hot gas
T1A/T1B/ T1C/T1D	Ther. mode	<b>Select thermostat control mode</b>  0: None 1: Individual On/Off 2: Common On/Off 4: MTR 5: PWM liquid control	1	5	1=Individual On/Off
R04	Evap.Pres.Ctrl by	<b>Evaporation pressure controlled by</b>  0: Room temperature 1: Evaporation pressure	0	1	0=Room temperature
R20	Refrigerant	<b>Select Refrigerant</b>  0: not used;1: R12;2: R22;3: R134a;4: R502;5: R717;6: R13;7: R13B1;8: R23;9: R500;10: R503;11: R114;12: R142b;13: User;14:R32;15:R227ea;16: R401A;17: R507A;18: R402A;19: R404A;20: R407C;21: R407A;22: R407B;23: R410A;24: R170;25: R290;26: R600;27: R600a;28: R744;29: R1270;30: R417A;31: R422A;32: R413A;33: R422D;34: R427A;35: R438A;36: R513A;37: R407F;38: R1234zeE;39: R1234yf;40: R448A;41: R449A;42: R452A;43: R450A;44: R452B;45: R454B;46:R1233zdE;47: R1234zeZ;48: R449B;49: R407H;	0	49	0=Not used
R2A	Liq. feed line valve	<b>Select type of valves in Liquid feed line</b>  1: Solenoid (ICFE): ON/OFF Solenoid ICF 20 Valve station 2: Solenoid (ICS): ON/OFF Solenoid ICS with EVM pilot 3: Solenoid (ICM): Motorized ICM, as slow opening/closing ON/OF valve. Occupy 1 DO	1	3	1=Solenoid (ICFE)
R2B	Liq. line valve for DX	<b>Select Liquid feed line valve for DX</b>  4: AKV: AKV or AKVA. Occupy 1 DO. DO5 or DO6 must be assigned 5: AKV + Solenoid: AKV or AKVA (Occupy 1 DO. DO5 or DO6 must be assigned) + Solenoid (Occupy 1 DO) 6: Mod ICM; Modulating motorized ICM. Occupy 1 AO 7: Mod ICM + solenoid: Modulating motorized ICM (Occupy 1 AO) + Solenoid (Occupy 1 DO) 8: 2 AKV: AKV or AKVA. Occupy 2 DO. DO5 or DO6 must be assigned 9: 2 AKV + Solenoid: AKV or AKVA. Occupy 2 DO, where DO5 or DO6 must be assigned, and 1 usual DO for solenoid valve in up stream	4	9	4=AKV
R2C	Liq. feed line valve PWM	<b>Select Liquid feed line valve for Modulating Thermostat (MTR) Flooded systems</b>  4: AKV: AKV or AKVA. Occupy 1 DO. DO5 or DO6 must be assigned 5: AKV + Solenoid: AKV or AKVA (Occupy 1 DO. DO5 or DO6 must be assigned) + Solenoid (Occupy 1 DO) 8: 2 AKV: AKV or AKVA. Occupy 2 DO. DO5 or DO6 must be assigned 9: 2 AKV + Solenoid: AKV or AKVA. Occupy 2 DO, where DO5 or DO6 must be assigned, and 1 usual DO for solenoid valve in up stream	4	9	4=AKV
D03/D3A	WR/SL valve	<b>Select type of valves in Wet Return Suction Line</b>  0: No valve 1: Soft (ICS+EVRST) 2: Soft (ICSH) 3: Soft (ICLX) 4: Solenoid (ICS) 5: Solenoid (ICM) 6: Slow (ICM) 7: Mod (ICM) 8: Mod+PE (ICM+EVRST) 9: Mod (CVE) 10: Mod+PE (CVE+ EVRST) 11: Mod+PE(CVE+EVM+EVRST)	0	11	3:Soft (ICLX)/7: Mod (ICM)
D2A	Hot gas line valve	<b>Select type of valves in Hot gas defrost line</b>  0: No Valve 1: Soft (ICS+EVRST): Dual position individual solenoid valves. Occupy 2 DO 2: Soft (ICSH): Dual position solenoid valve. Occupy 2 DO 3: Solenoid (ICFE): ON/OFF Solenoid ICF 20 Valve station 4: Solenoid (ICS):ON/OFF Solenoid ICS with EVM pilot 5: Solenoid (ICM):Motorized ICM, as slow opening/closing ON/OF valve. Occupy 1 DO 6: Slow (ICM): Motorized ICM, as slow opening/closing modulating valve. Occupy 1 AO	0	6	2=Soft (ICSH)

## Evaporator and room control, type EKE 400

Label ID <sup>(1)</sup>	Parameter name	Description and selection options	Min.	Max.	Factory setting
D1B	HG Drain valve	<b>Select type of valves in defrost drain line</b>  0: Pressure (ICS+CVP): Pressure control valve during hot gas defrost. CVP pilot have adjustable pressure setting 1: Pressure (OFV): Pressure control valve during hot gas defrost. OFV have adjustable pressure setting 2: Liquid drain (ICFD): Liquid drain during defrost	0	2	1=Pressure (ICS+CVP)
D2B	HG Drip tray DO	<b>Select possible DO hot gas valve for drip tray line</b>  No: No Drip tray valve/function Yes: Drip tray valve and function active	0=No	Yes=1	0=No
D4A	Drain solenoid?	<b>Decide if drain solenoid in defrost drain line is installed</b>  No Yes	0=No	1=Yes	1=Yes
D4B	Quick Drain?	<b>Decide if drain valve is installed to drain liquid quickly out before hot gas enter evaporator</b>  No Yes	0=No	1=Yes	0=No
T04	Ther. setpoint	<b>Thermostat set point temperature</b>	-70.0	160.0	2.0
T05	Ther. neutral zone	<b>Thermostat neutral zone</b>  Start/Stop limit around the "T03 Ther. Setpoint"	0.1	20.0	2.0
T17	Evap.Pres. SP To	<b>Evaporator pressure Setpoint in [C] / [F]</b>  Temperature Setpoint in [C]/[F] compared measured pressure value (calculated into [C]/[F])	-70.0	50.0	0.0
B02	High alarm limit	<b>High alarm limit</b>  High alarm for the room temperature alarm function. Entered as absolute value	-100.0	200.0	6.0
B03	Low alarm limit	<b>Low alarm limit</b>  Low alarm for the room temperature alarm function. Entered as absolute value	-100.0	200.0	-30.0
B04	Alarm delay	<b>Alarm delay</b>  Alarm delay time during normal control used for both high- and low temperature alarms	0	240	120
D11	Def. time interval	<b>Defrost start by time interval</b>  Fail safe function if another configured defrost start, has failed. A defrost will be started when the interval counter (real time) exceeds the 'Defrost time interval' setting. The interval counter is start counting from zero when the defrost is started. The interval counter will be reset at every defrost start. The interval counter shall be in standby (not counting) at "Main switch is OFF". Can be seen in Status Screen 1. If "D11,Def. time interval" is 0 (zero) the function is disabled	0	240	0
D12	Def. start acc. cool time	<b>Defrost start by accumulated cooling time</b>  Can also be used as a fail safe function if another configured defrost start, has failed. A defrost will be started when the accumulated cooling time exceeds "D12,Def. start acc. cool time" setting. The accumulated cooling time will be reset at every defrost start.	0	240	0
D14	Def. start by DI	<b>Defrost start by DI</b> Option to start defrost via DI. Typical external signal from PLC or a push bottom. If function is enabled, a defrost is started when the DI changes from OFF to ON. Successive change of the DI during the defrost period are ignored.  No: Function disable Yes: Function enabled"	0=No	1=Yes	0=No
D15	Def. start schedule	<b>Defrost start schedule</b> Option to run defrost according to local time scedules in EKE 400. Three schdules possible (weekdays, saturdays and sunday) with 6 defrost start time each  No: Function disable Yes:Function enabled"	0=No	1=Yes	0=No

## Evaporator and room control, type EKE 400

Label ID <sup>(1)</sup>	Parameter name	Description and selection options	Min.	Max.	Factory setting
D40	Defrost stop method	<b>Defrost stop method</b> Select method for stop of defrost  1: Stop on time: When the time delay "D58,Max defrost time" expires, the defrost is terminated 2: Stop on temp: When the defrost sensor temperature becomes greater than the set point "D43,Def. stop temp. limit", then the defrost is terminated. If the defrost time exceed "D58,Max defrost time", then the alarm 'Max defrost time' is send and the defrost is terminated. In case of sensor error, and the time 'Max defrost time' expires, the alarm 'Max defrost time' is send and the defrost is terminated. The alarm will automatically be reset after 5 minutes. To assign defrost sensor temperature, go to I/O configuration in Main menu and select an available AI"	1	2	1=Stop on time
D43	Def. stop temp. limit	<b>Defrost stop temperature limit</b> See description for "D40, Defrost stop method"	0.0	25.0	8.0
D50	Pump down delay	<b>Pump down delay</b> Draining the evaporator before defrosting. Always active The pump down state is used to empty the evaporator for liquid. See <a href="#">Figure 21: Defrost sequence</a> .	1	30	10
D51	HG open delay	<b>Hot Gas open delay</b> Time delay in minutes before opening the hot gas valve (delay for valve in the wet return line to close) See <a href="#">Figure 21: Defrost sequence</a> .	1	10	5
D5A	Drip tray pre-heat	<b>Drip tray pre-heat</b> Pre-heating time for hot gas to drip tray See <a href="#">Figure 21: Defrost sequence</a>	0	20	5
D5B	Drip tray delay OFF	<b>Drip tray delay OFF</b> Continue drip tray heating some defined time See <a href="#">Figure 21: Defrost sequence</a>	0	120	30
D57	Quick drain time	<b>Quick drain time</b> Enter how long time the Quick Drain valve stays open. Quick Drain valve will start opening together with Hot gas valve See <a href="#">Figure 21: Defrost sequence</a>	1	300	30
D53	HG soft time	<b>Hot gas soft time</b> Time between step 1 and step 2 for opening the hot gas valve (2 DO used) See <a href="#">Figure 21: Defrost sequence</a> .	1	30	3
D58	Max defrost time	<b>Max defrost time</b> Max. allowed defrost duration in minutes	1	120	30
D59	Drip off time	<b>Drip off time</b> Allow water on the evaporator to drip off. See <a href="#">Figure 21: Defrost sequence</a> .	1	15	5
D61	WR/SL soft time	<b>Wet Return/Suction Line valve soft time</b> Time between step 1 and step 2 for opening the Wet Return/Suction Line valve ("Soft (ICS+EVRST)" or "Soft (ICSH) See <a href="#">Figure 21: Defrost sequence</a> .	1	30	2
D6A	WR/SL main time	<b>Wet Return/Suction Line valve main time</b> After defrost and wet return valve has opened (main), enter delay before valve in liquid line to open. See <a href="#">Figure 21: Defrost sequence</a> .	1	30	2
D65	Fan start delay	<b>Fan start delay</b> The fan will be started when the time has elapsed. See <a href="#">Figure 21: Defrost sequence</a> .	0	30	2
P03	Main switch via DI	<b>Mainswitch via DI</b> Release EKE 400 for operation or force EKE 400 out of operation via external equipment (e.g. PLC), via DI  OFF: EKE 400 is forced out of operation. Observe if "M01,Main switch" is ON, this parameter will also when OFF, force EKE 400 out of operation ON: EKE 400 released for operation. Observe if "M01,Main switch" is ON, this parameter must also be ON, to release EKE 400 for operation	0=No	1=Yes	0=No

<sup>(1)</sup> Visibility depends on other parameter settings. Numbers are displayed in Metric units ( P01, Temperature units=MET)

## Parameter list

Observe that many of the individual parameters listed below, will only be visible, if other parameters have been set. Hereby irrelevant parameters are filtered out, during setup of EKE 400.

### NOTE:

1. See Label ID, G07, G08, G09.
2. All Modbus parameters is type: WORD (signed 16 bit).

## Start \ Stop

### SW version 1.71 and higher

Table 4: Start / Stop

Label ID <sup>(1)</sup>	Parameter name	Description and selection options	Min.	Max	Factory Setting	Decimals	Locked by Main switch Yes/No	Read	Password level to change/write	Modbus address	Read only (RO) / Read Write (RW)	Persistent Yes/No	Modbus function
M01	Main switch	<b>Release the controller for operation or force EKE 400 out of operation</b>  OFF: the controller is forced out of operation. Observe if "M02, Ext. Main switch" is ON, this DI will also when OFF, forced the controller out of operation ON: the controller released for operation. Observe if "M02, Ext. Main switch" is ON, this DI must also be ON to release the controller for operation	0=OFF	1=ON	0=OFF	0	No	Pass-word level 1,2,3	2	3001	RW	Yes	3, 4 & 16
M02	Ext. Main switch	<b>Status of the external main switch (DI)</b>	0=OFF	1=ON	-	0	Yes	Pass-word level 1,2,3	Can never be changed	3002	RO	Yes	3

<sup>(1)</sup> Visibility depends on other parameter settings. Numbers are displayed in Metric units ( P01, Temperature units=MET).

Evaporator control \ Evaporator control mode

Table 5: Evaporator control \ Evaporator control mode

Label ID <sup>(1)</sup>	Parameter name	Description and selection options	Min.	Max	Factory Setting	Decimals	Locked by Main switch Yes/No	Read	Password level to change/write	Modbus address	Read only (RO) / Read Write (RW)	Persistent Yes/No	Modbus function
R01	Evap. ctrl mode	<b>Evaporator control mode:</b> -1: None 0: Flood. evap. ON/OFF	-1	0	0=Flood. evap. On/Off;	0	Yes	Pass-word level 1,2,3	3	3020	RW	Yes	3, 4 & 16
R2A	Liq. feed line valve	<b>Select Liquid feed line valve</b> 1: Solenoid (ICFE): ON/OFF Solenoid ICF 20 Valve station 2: Solenoid (ICS): ON/OFF Solenoid ICS with EVM pilot 3: Solenoid (ICM): Motorized ICM, as ON/OFF valve. Occupy 1 DO	1	3	1	0	Yes	Pass-word level 1,2,3	3	3021	RW	Yes	3, 4 & 16
R2B	Liq. line valve for DX	<b>Select Liquid feed line valve for DX</b> 4: AKV: AKV or AKVA. Occupy 1 DO. DO5 or DO6 must be assigned 5: AKV + Solenoid: AKV or AKVA (Occupy 1 DO. DO5 or DO6 must be assigned) + Solenoid (Occupy 1 DO) 6: Mod ICM; Modulating motorized ICM. Occupy 1 AO 7: Mod ICM + solenoid: Modulating motorized ICM (Occupy 1 AO) + Solenoid (Occupy 1 DO) 8: 2 AKV: AKV or AKVA. Occupy 2 DO. DO5 or DO6 must be assigned 9: 2 AKV + Solenoid: AKV or AKVA. Occupy 2 DO, where DO5 or DO6 must be assigned, and 1 usual DO for solenoid valve in up stream	4	7	9	0	Yes	Pass-word level 1,2,3	3	3384	RW	Yes	3, 4 & 16
R2C	Liq. feed line valve PWM	<b>Select Liquid feed line valve for Modulating Thermostat (MTR) Flooded systems</b> 4: AKV: AKV or AKVA. Occupy 1 DO. DO5 or DO6 must be assigned 5: AKV + Solenoid: AKV or AKVA (Occupy 1 DO. DO5 or DO6 must be assigned) + Solenoid (Occupy 1 DO) 8: 2 AKV: AKV or AKVA. Occupy 2 DO. DO5 or DO6 must be assigned 9: 2 AKV + Solenoid: AKV or AKVA. Occupy 2 DO, where DO5 or DO6 must be assigned, and 1 usual DO for solenoid valve in up stream	4	9	4	0	Yes	Pass-word level 1,2,3	3	3380	RW	Yes	3, 4 & 16
R10	LL valve AI feedback	<b>Liquid Line feedback from ICAD on ICM valve</b> In IO configuration \ Analog inputs the Analog input type can be selected. 0-10 V;0-20 mA;4-20 mA;2-10 V  No: ICAD not connected to EKE 400 Yes: ICAD connected to EKE 400	No	Yes	No	0	Yes	Pass-word level 1,2,3	3	3446	RW	Yes	3, 4 & 16
R05	Cool On/Off by DI	<b>Cooling demand from external equipment (e.g. PLC) to EKE 400, via DI</b>	0=No	1=Yes	0=No	0	Yes	Pass-word level 1,2,3	3	3024	RW	Yes	3, 4 & 16
R06	Forced closing	<b>Forced stop cooling via MODBUS (e.g. PLC) or local from EKE 400</b>  If a PLC controls cooling ON/OFF, "R06,Forced closing" can be used to stop cooling  OFF: Function disabled ON: Forced stop cooling, regardless of cooling request. Observe. Will automatically after 15 min go back to OFF	0=OFF	1=ON	0=OFF	0	No	Pass-word level 1,2,3	2	3025	RW	No	3, 4 & 16

## Evaporator and room control, type EKE 400

Label ID <sup>(1)</sup>	Parameter name	Description and selection options	Min.	Max	Factory Setting	Decimals	Locked by Main switch Yes/No	Read	Password level to change/write	Modbus address	Read only (RO) / Read Write (RW)	Persistent Yes/No	Modbus function
R07	Forced cooling	<p><b>Forced cooling via MODBUS (e.g. PLC) or local from EKE 400</b></p> <p>The function is typical used to secure enough hot gas to defrost other evaporators. If a PLC controls cooling ON/OFF, "R07, Forced cooling" can be used to start cooling.</p> <p>OFF: Function disabled ON: Forced cooling, regardless of cooling request. Observe. Will automatically after 15 min go back to OFF</p>	0=OFF	1=ON	0=OFF	0	No	Password level 1,2,3	2	3026	RW	No	3, 4 & 16
R08	Forced close by DI	<p><b>Forced stop cooling via external equipment (e.g. PLC) to EKE 400, via DI</b></p> <p>If a PLC controls cooling ON/OFF, DI can be used to stop cooling.</p> <p>No: Function disabled Yes: Forced stop cooling, regardless of cooling request. To assign DI, go to I/O configuration in Main menu and select an available DI</p>	0=No	1=Yes	0=No	0	Yes	Password level 1,2,3	3	3027	RW	Yes	3, 4 & 16
R09	Forced cool by DI	<p><b>Forced cooling via external equipment (e.g. PLC) to EKE 400, via DI</b></p> <p>If a PLC controls cooling ON/OFF, DI can be used to start cooling.</p> <p>No: Function disabled Yes: Forced cooling, regardless of cooling request. To assign DI, go to I/O configuration in Main menu and select an available DI</p>	0=No	1=Yes	0=No	0	Yes	Password level 1,2,3	3	3028	RW	Yes	3, 4 & 16

<sup>(1)</sup> Visibility depends on other parameter settings. Numbers are displayed in Metric units ( P01, Temperature units=MET).

## Evaporator control \ Pressure configuration

**Table 6: Evaporator control \ Pressure configuration**

Label ID <sup>(1)</sup>	Parameter name	Description and selection options	Min.	Max	Factory Setting	Decimals	Locked by Main switch Yes/No	Read	Password level to change/write	Modbus address	Read only (RO) / Read Write (RW)	Persistent Yes/No	Modbus function
R20	Refrigerant	<b>Select Refrigerant</b> 0: not used;1: R12;2: R22;3: R134a;4: etc. 0: not used;1: R12;2: R22;3: R134a;4: R502;5: R717;6: R13;7: R13B1;8: R23;9: R500;10: R503;11: R114;12: R142b;13: User;14:R32;15:R227ea;16: R401A;17: R507A;18: R402A;19: R404A;20: R407C;21: R407A;22: R407B;23: R410A;24: R170;25: R290;26: R600;27: R600a;28: R744;29: R1270;30: R417A;31: R422A;32: R413A;33: R422D;34: R427A;35: R438A;36: R513A;37: R407F;38: R1234zeE;39: R1234yf;40: R448A;41: R449A;42: R452A;43: R450A;44: R452B;45: R454B;46:R1233zdE;47: R1234zeZ;48: R449B;49: R407H	0	49	0	0	Yes	Password level 1,2,3	3	3029	RW	Yes	3, 4 & 16
R23	Refrig fact. A1	<b>User defined refrigerant</b> When R20=13 (User defined refrigerant) Enter the Refrigerant factor A1 constants for the Antoine Equation for the actual refrigerant	8.000	13.000	10.400	3	Yes	Password level 1,2,3	3	3032	RW	Yes	3, 4 & 16
R24	Refrig fact. A2	<b>User defined refrigerant</b> When R20=13 (User defined refrigerant) Enter the Refrigerant factor A2 constants for the Antoine Equation for the actual refrigerant	-3200.0	-1200.0	-2255.0	1	Yes	Password level 1,2,3	3	3033	RW	Yes	3, 4 & 16
R25	Refrig fact. A3	<b>User defined refrigerant</b> When R20=13 (User defined refrigerant) Enter the Refrigerant factor A3 constants for the Antoine Equation for the actual refrigerant	220.0	320.0	254.2	1	Yes	Password level 1,2,3	3	3034	RW	Yes	3, 4 & 16

<sup>(1)</sup> Visibility depends on other parameter settings. Numbers are displayed in Metric units ( P01, Temperature units=MET).



## Evaporator control mode \ Evaporator DX control

Table 7: Evaporator control mode \ Evaporator DX control

Label ID <sup>(1)</sup>	Parameter name	Description and selection options	Min.	Max	Factory Setting	Decimals	Locked by Main switch Yes/No	Read	Password level to change/write	Modbus address	Read only (RO) / Read Write (RW)	Persistent Yes/No	Modbus function
N01	SH ref. mode	<b>Select Superheat reference mode:</b> 0: Fixed SH ref. Used when a stable fixed superheat is required 1: Load defined ctrl: LoadAp mode. Reference set in dependence of actual load (Opening Degree) Useful in applications with rapidly changing load conditions and at very short cut-in periods. 2: Adaptive SH ctrl: MSS (Minimum Stable Superheat) The superheat control algorithm will constantly lower the superheat reference, until some instability is registered	0	2	1= Load defined ctrl	0	x	Pass-word level 1,2,3	3	3003	RW	Yes	3, 4 & 16
N02	SH Fixed setpoint	<b>Superheat fixed setpoint</b> The superheat reference is fixed to this set point under all operating conditions	0.5	40.0	8.0	1		Pass-word level 1,2,3	3	3004	RW	Yes	3, 4 & 16
N03	SH max	<b>Superheat maximum</b> Maximum limitation of superheat reference	0.5	40.0	10.0	1	No	Pass-word level 1,2,3	2	3005	RW	Yes	3, 4 & 16
N04	SH min	<b>Superheat minimum</b> Minimum limitation of superheat reference Unit: °C/ °F	0.5	10.0	4.0	1	No	Pass-word level 1,2,3	2	3006	RW	Yes	3, 4 & 16
N05	SH Tn	<b>Superheat Integration time</b> Integration time (Tn) in PI controller Unit: °C/ °F	20	900	90	0	No	Pass-word level 1,2,3	3	3007	RW	Yes	3, 4 & 16
N06	SH Kp min	<b>Superheat minimum Proportional gain constant</b> Minimum proportional gain in Superheat PI controller Unit: °C/ °F	0.1	1.0	0.6	1	No	Pass-word level 1,2,3	3	3008	RW	Yes	3, 4 & 16
N07	SH Kp	<b>Superheat Proportional gain constant</b> Proportional gain in Superheat PI controller Unit: sec	0.1	20.0	1.5	1	No	Pass-word level 1,2,3	3	3009	RW	Yes	3, 4 & 16
N08	SH KpTe	<b>Superheat Pressure feedback gain</b> Proportional gain constant on saturated temperature	0	20.0	3.0	1	No	Pass-word level 1,2,3	3	3010	RW	Yes	3, 4 & 16
N09	SH close function	<b>Superheat close function</b> No: Function Disabled Yes: Function Enabled	0=No	1=Yes	1=Yes	0	Yes	Pass-word level 1,2,3	2	3011	RW	Yes	3, 4 & 16
N10	SH close setpoint	<b>Superheat close limit</b> If the superheat is below this value the valve in the liquid line is forced to close	-5.0	20.0	2.0	1	No	Pass-word level 1,2,3	3	3012	RW	Yes	3, 4 & 16
N11	SH close Tn divide	<b>Advanced parameter setting</b> For Danfoss only	1	5	3	0	No	Pass-word level 1,2,3	3	3013	RW	Yes	3, 4 & 16
N12	SH close Kp factor	<b>Advanced parameter setting</b> For Danfoss only Unit: °C/ °F	0.5	10	1.5	0	No	Pass-word level 1,2,3	3	3014	RW	Yes	3, 4 & 16

## Evaporator and room control, type EKE 400

Label ID <sup>(1)</sup>	Parameter name	Description and selection options	Min.	Max	Factory Setting	Decimals	Locked by Main switch Yes/No	Read	Password level to change/write	Modbus address	Read only (RO) / Read Write (RW)	Persistent Yes/No	Modbus function
N13	MOP function	<p><b>Maximum Operating Pressure</b></p> <p>MOPfunction will limit the valve opening degree such that the saturated evaporation temperature <math>T_e</math> is kept below the "N14,MOP" set point. MOP prevents overloading the compressor during start-up, by reducing suction pressure            No: Funtion Disabled            Yes: Function Enabled</p>	No	Yes	0=No	0	Yes	Password level 1,2,3	2	3015	RW	Yes	3, 4 & 16
N14	MOP setpoint	<p><b>Maximum Operating Pressure setpoint</b></p> <p>Active if "N13, MOP function" is set to Yes            The actual MOP Evaporator pressure Setpoint in [C] / [F]</p>	-70.0	50.0	0.0	1	No	Password level 1,2,3	2	3016	RW	Yes	3, 4 & 16
N15	MTR Tn	<p><b>Advanced parameter</b></p> <p>Integration time for the MTR algorithm</p>	20	3600	1800	0	No	Password level 1,2,3	3	3017	RW	Yes	3, 4 & 16
N16	MTR Kp	<p><b>Advanced parameter</b></p> <p>Proportional factor for the MTR algorithm            Unit: °C / °F</p>	20	3600	1800	0	No	Password level 1,2,3	3	3018	RW	Yes	3, 4 & 16
N17	AKV period	<p><b>AKV or AKVA period time</b></p> <p>Period time of AKV or AKVA            Example: "N17, AKV Period" is set to 6 sec., the Opening Degree is calculated to 40 %, then AKV or AKVA is open in 2,4 sec., and closed in 3, 6 sec</p>	3	6	6	0	Yes	Password level 1,2,3	2	3019	RW	Yes	3, 4 & 16
N18	MSS stability	<p><b>Minimum Stable Superheat stability</b></p> <p>Stability factor for regulation of superheat, only relevant for MSS. With a higher value the control function will allow a greater fluctuation of the superheat before the reference is changed.</p>	0.0	10.0	5.0	1	Yes	Password level 1,2,3	3	3397	RW	Yes	3, 4 & 16
N19	MSS T0 stability factor	<p><b>Minimum Stable Superheat stability T0 factor</b></p> <p>Only relevant for MSS. T0 stability factor defines if variation in suction pressure will influence superheat reference. The SH reference change can be adjusted in the range from 0.0 to 1.0            A value of 1.0 will give max T0 influence and S2.            A value of 0.0 will give influence on S2 only.</p> <p>With often change in suction pressure due to compressor start/stop, some T0 (and S2) influence on MSS is recommended.</p>	0.0	1.0	0.0	1	Yes	Password level 1,2,3	3	3390	RW	Yes	3, 4 & 16
N20	Startup Mode	<p><b>Startup Mode (See section Start Up)</b></p> <p>After startup, this function will provide a constant opening degree during a set time period regardless of the superheat value. No limiters are taken in consideration during this time.</p> <p>0: Prop.Ctrl: Proportional (P) control            1: Fix OD w prot: Predefined OD (parameter "N23, Startup OD") with protection            2: Fix OD wo prot: Predefined OD (parameter "N23, Startup OD") without protection</p>	0	2	0	0	Yes	Password level 1,2,3	3	3393	RW	Yes	3, 4 & 16
N21	Startup time	<p><b>Startup time (See section Start Up)</b></p> <p>This parameter is related to "N20, Startup Mode"            Unit: sec</p>	1	600	90	0	Yes	Password level 1,2,3	3	3394	RW	Yes	3, 4 & 16

## Evaporator and room control, type EKE 400

Label ID <sup>(1)</sup>	Parameter name	Description and selection options	Min.	Max	Factory Setting	Decimals	Locked by Main switch Yes/No	Read	Password level to change/write	Modbus address	Read only (RO) / Read Write (RW)	Persistent Yes/No	Modbus function
N22	Min.startup time	<b>Min.startup time (See section Start Up)</b> This parameter is related to "N20, Startup Mode" <i>Unit: sec</i>	1	240	15	0	Yes	Password level 1,2,3	3	3395	RW	Yes	3, 4 & 16
N23	Startup OD	<b>Startup Opening Degree (See section Start Up)</b> This parameter is related to "N20, Startup Mode" <i>Unit: %</i>	1	100	32	0	Yes	Password level 1,2,3	3	3396	RW	Yes	3, 4 & 16
N24	Minimum OD	<b>Minimum Opening Degree</b> When required, the valve minimum OD can be set to a required minimum opening position, such feature is helpful where the system always requires some minimum flow. The minimum OD limit has effect in injection control mode only <i>Unit: %</i>	0	100	0	0	Yes	Password level 1,2,3	3	3398	RW	Yes	3, 4 & 16
N25	Maximum OD	<b>Maximum Opening Degree</b> This is useful feature to limit the maximum OD of a oversized valve used in the system. By default the maximum OD of a valve is set at 100 OD%. This maximum OD % can be set to lower value if required. The maximum OD limit has effect in injection control mode only <i>Unit: %</i>	0	100	100	0	Yes	Password level 1,2,3	3	3399	RW	Yes	3, 4 & 16
N26	Limit Kp	<b>Limit Kp - Superheat configuration Advance</b> Proportional gain	1.0	20.0	5.0	1	Yes	Password level 1,2,3	3	3400	RW	Yes	3, 4 & 16
N27	Limit Tn	<b>Limit Tn - Superheat configuration Advance</b> Integration time <i>Unit: sec</i>	20	900	45	0	Yes	Password level 1,2,3	3	3401	RW	Yes	3, 4 & 16
N36	S3 air in.temp.AI?	<b>Air temperature sensor (S3) installed?</b> Used for MTR 0: No not installed 1: Yes installed To assign AI, go to I/O configuration in Main menu and select an available AI	0	1	0	0	Yes	Password level 1,2,3	3	3405	RW	Yes	3, 4 & 16
N28	Ext.Ref.DX config	<b>External reference DX configuration Select the signal used to change the Superheat reference.</b> 0: Not used 1: Displace by current: - define the AI input range via the following settings: "N31,Ref.Current SH High": 4 to 20 mA, default = 20 "N32,Ref.Current SH Low": 0 to 20 mA, default = 4 To assign AI, go to I/O configuration in Main menu and select an available AO 2: Displace by voltage: - define the AI input range via the following settings: "N33,Ref.Voltage SH High": 0 to 10 Volt, default = 10 "N34,Ref.Voltage SH Low": 0 to 10 Volt, default = 0 To assign AI, go to I/O configuration in Main menu and select an available AI. 3: Displace by MODBUS 4: Displace by DI	0	4	0	0	Yes	Password level 1,2,3	3	3402	RW	Yes	3, 4 & 16

## Evaporator and room control, type EKE 400

Label ID <sup>(1)</sup>	Parameter name	Description and selection options	Min.	Max	Factory Setting	Decimals	Locked by Main switch Yes/No	Read	Password level to change/write	Modbus address	Read only (RO) / Read Write (RW)	Persistent Yes/No	Modbus function
N29	Ref.Offset SH Max	<b>Reference offset Superheat maximum</b> Scaling of range for superheat displacement - Maximum value. See "N28, Ext.Ref.DX config" Unit: K	0.0	50.0	0.0	1	No	Pass-word level 1,2,3	3	3410	RW	Yes	3, 4 & 16
N30	Ref.Offset SH Min	<b>Reference offset Superheat minimum</b> Scaling of range for temperature displacement - Minimum value See "N28, Ext.Ref.DX config" Unit: K	-50.0	0.0	0.0	1	No	Pass-word level 1,2,3	3	3409	RW	Yes	3, 4 & 16
N31	Ref.Current SH High	<b>Reference current Superheat high</b> Scaling of range for AI current - high value See "N28, Ext.Ref.DX config" Unit: mA	N32	20.0	20.0	1	No	Pass-word level 1,2,3	3	3354	RW	Yes	3, 4 & 16
N32	Ref.Current SH Low	Reference current Superheat low Scaling of range for AI current - low value See "N28, Ext.Ref.DX config" Unit: mA	0.0	N31	4.0	1	No	Pass-word level 1,2,3	3	3355	RW	Yes	3, 4 & 16
N33	Ref.Voltage SH High	<b>Reference voltage Superheat high</b> Scaling of range for AI voltage - high value See "N28, Ext.Ref.DX config" Unit: V	N34	10.0	10.0	1	No	Pass-word level 1,2,3	3	3356	RW	Yes	3, 4 & 16
N34	Ref.Voltage SH Low	<b>Reference voltage Superheat low</b> Scaling of range for AI voltage - low value See "N28, Ext.Ref.DX config" Unit: V	0.0	N33	0.0	1	No	Pass-word level 1,2,3	3	3357	RW	Yes	3, 4 & 16
N35	Re.Offset SH Modbus	<b>Reference offset Superheat by MODBUS</b> Offset value via MODBUS (e.g. PLC) added to current SH reference. Unit: K	-50.0	50.0	0.0	1	No	Pass-word level 1,2,3	3	3358	RW	Yes	3, 4 & 16
N38	Ref. Offset SH by DI	<b>Reference Offset Superheat when DI is open, 0 K if closed</b> If P10, Ext ref. config.=Displace by DI, then if the assigned DI:  OFF: No offset added ON: Value entered here will be added to SuperHeat reference Unit: K	-70.0	50.0	0.0	1	No	Pass-word level 1,2,3	3	3470	RW	Yes	3, 4 & 16
N37	Tn SH tracking	<b>Tn SH tracking</b>  Unit: sec	3	600	200	0	No	Pass-word level 1,2,3	3	3413	RW	Yes	3, 4 & 16

<sup>(1)</sup> Visibility depends on other parameter settings. Numbers are displayed in Metric units ( P01, Temperature units=MET).

## Evaporator control \ Valve configuration

**Table 8: Evaporator control \ Valve configuration**

Label ID <sup>(1)</sup>	Parameter name	Description and selection options	Min.	Max	Factory Setting	Decimals	Locked by Main switch Yes/No	Read	Password level to change/write	Mod-bus address	Read only (RO) / Read Write (RW)	Persistent Yes/No	Mod-bus function
R2A	Liq. feed line valve	<p><b>Select type of valves in Liquid feed line</b></p> <p>1:Solenoid (ICFE): ON/OFF Solenoid ICF 20 Valve station</p> <p>2:Solenoid (ICS): ON/OFF Solenoid ICS with EVM pilot</p> <p>3:Solenoid (ICM): Motorized ICM, as slow opening/closing ON/OFF valve. Occupy 1 DO</p>	1	3	1	0	Yes	Pass-word level 1,2,3	3	3021	RW	Yes	3, 4 & 16
R2B	Liq. line valve for DX	<p><b>Select Liquid feed line valve for DX</b></p> <p>4: AKV: AKV or AKVA. Occupy 1 DO. DO5 or DO6 must be assigned</p> <p>5: AKV + Solenoid: AKV or AKVA (Occupy 1 DO. DO5 or DO6 must be assigned) + Solenoid (Occupy 1 DO)</p> <p>6: Mod ICM; Modulating motorized ICM. Occupy 1 AO</p> <p>7: Mod ICM + solenoid: Modulating motorized ICM (Occupy 1 AO) + Solenoid (Occupy 1 DO)</p> <p>8: 2 AKV: AKV or AKVA. Occupy 2 DO. DO5 or DO6 must be assigned</p> <p>9: 2 AKV + Solenoid: AKV or AKVA. Occupy 2 DO, where DO5 or DO6 must be assigned, and 1 usual DO for solenoid valve in up stream</p>	4	7	9	0	Yes	Pass-word level 1,2,3	3	3384	RW	Yes	3, 4 & 16
R2C	Liq. feed line valve PWM	<p><b>Select Liquid feed line valve for Modulating Thermostat (MTR) Flooded systems</b></p> <p>4: AKV: AKV or AKVA. Occupy 1 DO. DO5 or DO6 must be assigned</p> <p>5: AKV + Solenoid: AKV or AKVA (Occupy 1 DO. DO5 or DO6 must be assigned) + Solenoid (Occupy 1 DO)</p> <p>8: 2 AKV: AKV or AKVA. Occupy 2 DO. DO5 or DO6 must be assigned</p> <p>9: 2 AKV + Solenoid: AKV or AKVA. Occupy 2 DO, where DO5 or DO6 must be assigned, and 1 usual DO for solenoid valve in up stream</p>	4	9	4	0	Yes	Pass-word level 1,2,3	3	3380	RW	Yes	3, 4 & 16

## Evaporator and room control, type EKE 400

Label ID <sup>(1)</sup>	Parameter name	Description and selection options	Min.	Max	Factory Setting	Decimals	Locked by Main switch Yes/No	Read	Password level to change/write	Mod-bus address	Read only (RO) / Read Write (RW)	Persistent Yes/No	Mod-bus function
D3A	WR/SL valve	<p><b>Select type of valves in Wet Return Suction Line</b></p> <p>0: No Valve            1: Soft (ICS+EVRST): Dual position individual solenoid valves. Occupy 2 DO            2: Soft (ICSH): Dual position solenoid valve. Occupy 2 DO            3: Soft (ICLX): 2-step gas powered solenoid valve. Occupy 1 DO            4: Solenoid (ICS):ON/OFF Solenoid ICS with EVM pilot            5: Solenoid (ICM):Motorized ICM, as slow opening/closing ON/OF valve. Occupy 1 DO            6: Slow (ICM): Motorized ICM, as slow opening/closing modulating valve. Occupy 1 AO</p>	0	6	3	0	Yes	Pass-word level 1,2,3	3	3253	RW	Yes	3, 4 & 16
D03	WR/SL valve	<p><b>Select type of valves in Wet Return Suction Line</b></p> <p>7: Mod (ICM): Modulating motorized ICM. Occupy 1 AO            8: Mod+PE (ICM+EVRST): Modulating motorized ICM, occupy 1 AO and Solenoid for pressure pressure equalization at opening, occupy 1 DO            9: Mod (CVE): Electronic pressure pilot. Occupy 1 AO            10: Mod+PE (CVE+ EVRST): Electronic pressure pilot. Occupy 1 AO and Solenoid for pressure pressure equalization at opening, occupy 1 DO            11: Mod+PE(CVE+EVM +EVRST): Electronic pressure pilot. Occupy 1 AO and two solenoid , occupy 2 DO. When installed in a ICS 3 topcover. SI port: EVM, to secure valve closed during defrost. SII port: CVE. P port: Blocked. EVRST: For pressure pressure equalization at opening</p>	7	11	7	0	Yes	Pass-word level 1,2,3	3	3388	RW	Yes	3, 4 & 16
D3A	WR/SL valve	<p><b>Valve in wet return/suction line</b></p> <p>0: No valve            1: Soft (ICS+EVRST)            2: Soft (ICSH)            3: Soft (ICLX)            4: Solenoid (ICS)            5: Solenoid (ICM)            6: Slow (ICM)</p>	0	6	3	0	Yes	Pass-word level 1,2,3	3	3253	RW	Yes	3, 4 & 16

## Evaporator and room control, type EKE 400

Label ID <sup>(1)</sup>	Parameter name	Description and selection options	Min.	Max	Factory Setting	Decimals	Locked by Main switch Yes/No	Read	Password level to change/write	Mod-bus address	Read only (RO) / Read Write (RW)	Persistent Yes/No	Mod-bus function
D2A	Hot gas line valve	<p><b>Select type of valves in Hot gas defrost line</b></p> <p>0: No Valve            1: Soft (ICS+EVRST): Dual position individual solenoid valves. Occupy 2 DO            2: Soft (ICSH): Dual position solenoid valve. Occupy 2 DO            3: Solenoid (ICFE): ON/OFF Solenoid ICF 20 Valve station            4: Solenoid (ICS):ON/OFF Solenoid ICS with EVM pilot            5: Solenoid (ICM):Motorized ICM, as slow opening/closing ON/OF valve. Occupy 1 DO            6: Slow (ICM): Motorized ICM, as slow opening/closing modulating valve. Occupy 1 AO</p>	0	6	2	0	Yes	Password level 1,2,3	3	3247	RW	Yes	3, 4 & 16
D2C	HG valve AI feedback	<p><b>Hotgas Line feedback from ICAD on ICM valve</b></p> <p>In IO configuration \ Analog inputs the Analog input type can be selected. 0-10 V;0-20 mA;4-20 mA;2-10 V</p> <p>No: ICAD not connected to EKE 400            Yes: ICAD connected to EKE 400</p>	No	Yes	No	0	Yes	Password level 1,2,3	3	3451	RW	Yes	3, 4 & 16
D1B	HG Drain valve	<p><b>Select type of valves in defrost drain line</b></p> <p>0:Pressure (ICS+CVP): Pressure control valve during hot gas defrost. CVP pilot have adjustable pressure setting            1: Pressure (OFV): Pressure control valve during hot gas defrost. OFV have adjustable pressure setting            2: Liquid drain (ICFD): Liquid drain during defrost</p>	0	2	1	0	Yes	Password level 1,2,3	3	3245	RW	Yes	3, 4 & 16

<sup>(1)</sup> Visibility depends on other parameter settings. Numbers are displayed in Metric units ( P01, Temperature units=MET).

Air temperature control \ Thermostat function

Table 9: Air temperature control \ Thermostat function

Label ID <sup>(1)</sup>	Parameter name	Description and selection options	Min.	Max	Factory Setting	Decimals	Locked by Main switch Yes/No	Read	Password level to change/write	Modbus address	Read only (RO) / Read Write (RW)	Persistent Yes/No	Modbus function
T26	Evap.Pres.Control	<b>Evaporation pressure control</b> Enter mode 0: Yes 1: No	No	Yes	No	0	No	Pass-word level 1,2,3	3	3517	RW	Yes	3, 4 & 16
T1A	Ther. mode	<b>Select thermostat control mode</b> 0: None 1: Individual On/Off 2: Common On/Off 5: PWM liquid control	0	5	1	0	Yes	Pass-word level 1,2,3	3	3037	RW	Yes	3, 4 & 16
T1B	Ther. mode	<b>Thermostat control mode for DX regulation</b> 0: None 1: Individual On/Off 2: Common On/Off 4: MTR: Modulating:Thermostat (MTR) in Liquid Line. Flooded systems	0	4	1	0	Yes	Pass-word level 1,2,3	2	3386	RW	Yes	3, 4 & 16
T1C	Ther. mode	<b>Thermostat control mode when + Evaporation pressure control by Pressure</b> If Evaporation pressure control selected (T26,Evap.Pres.Control=Yes) 0: None 1: Individual On/Off 2: Common On/Off ;	0	2	0	0	Yes	Pass-word level 1,2,3	3	3500	RW	Yes	3, 4 & 16
T1D	Ther. mode	<b>Thermostat control mode when + Evaporation pressure control by Temperature</b> If Evaporation pressure control selected (T26,Evap.Pres.Control=Yes) 0: None 1: Individual On/Off	0	1	0	0	Yes	Pass-word level 1,2,3	3	3501	RW	Yes	3, 4 & 16
R04	Evap.Pres.Ctrl by	<b>Evaporation pressure controlled by</b> 0: Room temperature 1: Evaporation pressure	0	1	0		Yes	Pass-word level 1,2,3	3	3022	RW	Yes	3, 4 & 16
T02	No. of ther. sensor	<b>Number of temperature sensors connected to EKE 400</b> It is possible to connect up to 3 room thermostat sensors to the same controller. Typically, only one thermostat sensor is connected, but sometimes more sensors are connected to avoid "hot spots" in a room. 0: No thermostat sensor connected 1: One thermostat sensor connected 2: Two thermostat sensors connected 3: Three thermostat sensors connected	0	3	1	0	Yes	Pass-word level 1,2,3	2	3038	RW	Yes	3, 4 & 16
T03	Ctrl temp. method	<b>Control method</b> The control method shall be selected if common thermostat is selected or if more thermostat sensors are connected to EKE 400. The temperatures used of thermostat is selected by setting of "T03, Ctrl temp. method": 0:Ctrl highest temp: 1:Ctrl average temp.:	0	1	0	0		Pass-word level 1,2,3	2	3039	RW	Yes	3, 4 & 16
T04	Ther. setpoint	<b>Thermostat set point temperature</b> <i>Unit: °C / °F</i>	-70.0	160.0	2.0	1		Pass-word level 1,2,3	2	3040	RW	Yes	3, 4 & 16



## Evaporator and room control, type EKE 400

Label ID <sup>(1)</sup>	Parameter name	Description and selection options	Min.	Max	Factory Setting	Decimals	Locked by Main switch Yes/No	Read	Password level to change/write	Modbus address	Read only (RO) / Read Write (RW)	Persistent Yes/No	Modbus function
T05	Ther. neutral zone	<b>Thermostat neutral zone</b>  Start/Stop limit around the "T03 Ther. Setpoint" <i>Unit: K</i>	0.1	20.0	2.0	1		Password level 1,2,3	2	3041	RW	Yes	3, 4 & 16
T06	Day/night control	<b>Day/Night control</b> Function that allow to add an offset value to "T03 Ther. Setpoint"  No: Function disabled Yes: Function enabled. Night status visible in Status Screen 1 See "T08,Night offset"	No	Yes	No	0		Password level 1,2,3	3	3042	RW	Yes	3, 4 & 16
T07	Night operation	<b>Night Operation</b> Enable function to offset "T04,Ther. Setpoint", typical via MODBUS (e.g. PLC)  No: Day operation : No offset - not active Yes: Night operation. If "T06, Day/night control" is Yes, then add "T08, Night offset" to "T04,Ther. Setpoint"	No	Yes	No	0		Password level 1,2,3	2	3043	RW	Yes	3, 4 & 16
T08	Night offset	<b>Night offset</b>  Enter the Offset value to thermostat set point temperature. See "T07, Night operation" <i>Unit: K</i>	-20.0	20.0	-2.0	1	No	Password level 1,2,3	2	3044	RW	Yes	3, 4 & 16
T09	Cool. status DO	<b>Cooling status DO</b> Select status if Evapartor is in cooling mode and read out to Digital Output Actual cooling status to be read on a DO.  No:Funtion Disabled Yes:Function Enabled. If Evapartor is in cooling mode then DO is ON, otherwise DO is OFF. To assign DO, go to I/O configuration in Main menu and select an available DO.	No	Yes	No	0	Yes	Password level 1,2,3	3	3045	RW	Yes	3, 4 & 16
T22	Min.Cooling OD	<b>Minimum Cooling Opening Degree limit</b>  A limit can be defined to manage: - Text in HMI: "Cooling Status" to display "OFF" or "ON" - Cooling status DO, parameter "T09, Cool. status DO", when set to "Yes"  If OD > ("T22,Min.Cooling OD" ) then "Cooling Status" will display ON Assigned DO related to "T09, Cool. status DO" is ON If OD = 0% then "Cooling Status" will display OFF Assigned DO related to "T09, Cool. status DO" is OFF <i>Unit: %</i>	0	20	5	0	Yes	Password level 1,2,3	3	3437	RW	Yes	3, 4 & 16
T10	Pwm mod.period	<b>Modulating Thermostat (MTR) in Liquid Line. Flooded systems - period time</b>  Expert setting - The value should only be changed by specially trained staff <i>Unit: sec</i>	30	900	300	0	Yes	Password level 1,2,3	3	3374	RW	Yes	3, 4 & 16
T11	Pwm Max OD	<b>Modulating Thermostat (MTR) in Liquid Line. Flooded systems - Max OD</b>  Maximum opening degree of the AKV or AKVA in the liquid line <i>Unit: %</i>	10	100	100	0	Yes	Password level 1,2,3	3	3375	RW	Yes	3, 4 & 16

## Evaporator and room control, type EKE 400

Label ID <sup>(1)</sup>	Parameter name	Description and selection options	Min.	Max	Factory Setting	Decimals	Locked by Main switch Yes/No	Read	Password level to change/write	Modbus address	Read only (RO) / Read Write (RW)	Persistent Yes/No	Modbus function
T12	Pwm Min OD	<b>Modulating Thermostat (MTR) in Liquid Line. Flooded systems - Min OD</b>  Minimum opening degree of the AKV or AKVA in the liquid line <i>Unit: %</i>	0	100	0	0	Yes	Pass-word level 1,2,3	3	3376	RW	Yes	3, 4 & 16
T13	Pwm Kp	<b>Modulating Thermostat (MTR) in Liquid Line. Flooded systems - Amplification factor</b>  Expert setting - The value should only be changed by specially trained staff	0.5	10.0	4.0	1	Yes	Pass-word level 1,2,3	3	3377	RW	Yes	3, 4 & 16
T14	Pwm Tn	<b>Modulating Thermostat (MTR) in Liquid Line. Flooded systems - Integration time</b>  Expert setting - The value should only be changed by specially trained staff <i>Unit: sec</i>	60	1800	300	0	Yes	Pass-word level 1,2,3	3	3378	RW	Yes	3, 4 & 16
T15	Desynch. Pwm	<b>Desynchronization of Modulating Thermostat (MTR) in Liquid Line. Flooded systems</b>  Pwm duty to avoid simultaneousness with other control	No	Yes	No	0	Yes	Pass-word level 1,2,3	3	3412	RW	Yes	3, 4 & 16
T17	Evap.Pres. SP To	<b>Evaporator pressure Setpoint in [C] / [F]</b>  Setpoint coming from pressure converted in temperature depending from selected refrigerant <i>Unit: °C / °F</i>	-70.0	50.0	0	1	No	Pass-word level 1,2,3	2	3415	RW	Yes	3, 4 & 16
T18	Evap.Pres. Kp	<b>Proportional gain for Evaporation pressure control</b>  Proportional factor	0.5	50.0	3.0	1	No	Pass-word level 1,2,3	3	3418	RW	Yes	3, 4 & 16
T19	Evap.Pres. Tn	<b>Integration time for Evaporation pressure control</b>  Integration time <i>Unit: sec</i>	60	600	240	0	No	Pass-word level 1,2,3	3	3419	RW	Yes	3, 4 & 16
T20	Evap.Pres. Td	<b>Derivative time for Evaporation pressure control</b>  Differential time <i>Unit: sec</i>	0	60	10	0	No	Pass-word level 1,2,3	3	3420	RW	Yes	3, 4 & 16
T21	Evap.Pres. mode	<b>Evaporation pressure control mode</b>  Select between: 0: Normal 1: Min underswing 2: No underswing	0	2	2	0	Yes	Pass-word level 1,2,3	3	3421	RW	Yes	3, 4 & 16
T24	Limit LL	<b>Close Liquid Line valve in DX mode</b>  Select function When OD is below T25, OD Limit LL then close Liquid Line valve 0: No 1: Yes	No	Yes	No	0	No	Pass-word level 1,2,3	0	3507	RW	Yes	3, 4 & 16
T25	OD Limit LL	<b>Opening Degree Limit in percentage</b>  See T24, OD Limit LL	0.0	100.0	0.0	1	No	Pass-word level 1,2,3	0	3508	RW	Yes	3, 4 & 16

<sup>(1)</sup> Visibility depends on other parameter settings. Numbers are displayed in Metric units ( P01, Temperature units=MET).

## Air temperature control \ Air temp. Alarm

**Table 10: Air temperature control \ Air temp. Alarm**

Label ID <sup>(1)</sup>	Parameter name	Description and selection options	Min.	Max	Factory Setting	Decimals	Locked by Main switch Yes/No	Read	Password level to change/write	Modbus address	Read only (RO) / Read Write (RW)	Persistent Yes/No	Modbus function
B01	Air temp. alarm	<b>Select which temperature sensor shall be connected to temperature alarms.</b>  0:None: No temperature alarms active 1:Seperate sensor: A separate sensor for the alarm function 2:Thermostat temp: The Thermostat temperature sensot is used for the alarm function	0	2	2=Thermostat temp.	0	Yes	Pass-word level 1,2,3	3	3046	RW	Yes	3, 4 & 16
B02	High alarm limit	<b>High alarm limit</b>  High alarm for the room temperature alarm function. Entered as absolute value <i>Unit: °C/ °F</i>	-100.0	200.0	6.0	1	No	Pass-word level 1,2,3	2	3047	RW	Yes	3, 4 & 16
B03	Low alarm limit	<b>Low alarm limit</b>  Low alarm for the room temperature alarm function. Entered as absolute value. <i>Unit: °C/ °F</i>	-100.0	200.0	-30.0	1	No	Pass-word level 1,2,3	2	3048	RW	Yes	3, 4 & 16
B04	Alarm delay	<b>Alarm delay</b>  Alarm delay time during normal control used for both high- and low temperature alarms <i>Unit: min</i>	0	240	120	0	No	Pass-word level 1,2,3	2	3049	RW	Yes	3, 4 & 16

<sup>(1)</sup> Visibility depends on other parameter settings. Numbers are displayed in Metric units ( P01, Temperature units=MET).

## Air temperature control \ Product temperature alarm function

Table 11: Air temperature control \ Product temperature alarm function

Label ID <sup>(1)</sup>	Parameter name	Description and selection options	Min.	Max	Factory Setting	Decimals	Locked by Main switch Yes/No	Read	Password level to change/write	Modbus address	Read only (RO) / Read Write (RW)	Persistent Yes/No	Modbus function
B05	Product alarm function	<p><b>Product temperature alarm</b></p> <p>The air temperature is not always representative for the temperature of the products. A product sensor to measure the actual temperature in between the products. This sensor is used for monitoring purposes only including alarm handling.</p> <p>No: Function disabled Yes: Function enabled. Product alarms active. "Product temp." can be seen in Status Screen 1</p>	0=No	1=Yes	0=No	0	Yes	Pass-word level 1,2,3	3	3050	RW	Yes	3, 4 & 16
B06	Prod. high alarm limit	<p><b>Product High alarm</b></p> <p>High alarm limit for the product temperature alarm function. Entered as absolute value <i>Unit: °C / °F</i></p>	-100.0	200.0	6.0	1	No	Pass-word level 1,2,3	2	3051	RW	Yes	3, 4 & 16
B07	Prod. low alarm limit	<p><b>Product Low alarm</b></p> <p>Low alarm limit for the product temperature <i>Unit: °C / °F</i></p>	-100.0	200.0	-30.0	1	No	Pass-word level 1,2,3	2	3052	RW	Yes	3, 4 & 16
B08	Prod. alarm delay	<p><b>Product Alarm delay</b></p> <p>Alarm delay time used for both high and low product temperature alarm function <i>Unit: min</i></p>	0	240	120	0	No	Pass-word level 1,2,3	2	3053	RW	Yes	3, 4 & 16

<sup>(1)</sup> Visibility depends on other parameter settings. Numbers are displayed in Metric units ( P01, Temperature units=MET).

## Defrost function \ Defrost method

**Table 12: Defrost function \ Defrost method**

Label ID <sup>(1)</sup>	Parameter name	Description and selection options	Min.	Max	Factory Setting	Decimals	Locked by Main switch Yes/No	Read	Password level to change/write	Modbus address	Read only (RO) / Read Write (RW)	Persistent Yes/No	Modbus function
D1A	Defrost method	<b>Select the defrost method</b> 0: No defrost: No defrost function 1: Hot gas: Defrost done by Hot gas If air defrost is (used in rooms with temperature higher than 0° C (32 °F) 2: Electrical, water or air defrost (air defrost in rooms with temperature higher than 0° C (32 °F))	0	1	1=Hot gas	0	Yes	Pass-word level 1,2,3	3	3244	RW	Yes	3, 4 & 16
D1B	HG Drain valve	<b>Select type of valves in defrost drain line</b> 0: Pressure (ICS+CVP): Pressure control valve during hot gas defrost. CVP pilot have ajustable pressure setting 1: Pressure (OFV): Pressure control valve during hot gas defrost. OFV have ajustable pressure setting 2: Liquid drain (ICFD): Liquid drain during defrost	0	2	1= Pressure (ICS + CVP)	0	Yes	Pass-word level 1,2,3	3	3245	RW	Yes	3, 4 & 16
D2A	Hot gas line valve	<b>Select type of valves in Hot gas defrost line</b> 0: No Valve 1: Soft (ICS+EVRST): Dual position individual solenoid valves. Occupy 2 DO 2: Soft (ICSH): Dual position solenoid valve. Occupy 2 DO 3: Solenoid (ICFE): ON/OFF Solenoid ICF 20 Valve station 4: Solenoid (ICS):ON/OFF Solenoid ICS with EVM pilot 5: Solenoid (ICM):Motorized ICM, as slow opening/closing ON/OF valve. Occupy 1 DO 6: Slow (ICM): Motorized ICM, as slow opening/closing modulating valve. Occupy 1 AO	0	6	2=Soft (ICSH)	0	Yes	Pass-word level 1,2,3	3	3247	RW	Yes	3, 4 & 16
D2B	HG Drip tray DO	<b>Select possible DO hot gas valve for drip tray line</b> No: No Drip tray valve/function Yes: Drip tray valve and function active	0=No	1=Yes	0=No	0	Yes	Pass-word level 1,2,3	3	3255	RW	Yes	3, 4 & 16
D3A	WR/SL valve	<b>Select type of valves in Wet Return Suction Line</b> 0: No Valve 1: Soft (ICS+EVRST): Dual position individual solenoid valves. Occupy 2 DO 2: Soft (ICSH): Dual position solenoid valve. Occupy 2 DO 3: Soft (ICLX): 2-step gas powered solenoid valve. Occupy 1 DO 4: Solenoid (ICS):ON/OFF Solenoid ICS with EVM pilot 5: Solenoid (ICM):Motorized ICM, as slow opening/closing ON/OF valve. Occupy 1 DO 6: Slow (ICM): Motorized ICM, as slow opening/closing modulating valve. Occupy 1 AO	0	6	3	0	Yes	Pass-word level 1,2,3	3	3253	RW	Yes	3, 4 & 16
D03	WR/SL valve	<b>Valve in wet return/suction line</b> 7: Mod (ICM) 8: Mod+PE (ICM+EVRST) 9: Mod (CVE) 10: Mod+PE (CVE+EVRST) 11: Mod+PE (CVE+EVM+EVRST)	7	11	7	0	Yes	Pass-word level 1,2,3	3	3388	RW	Yes	3, 4 & 16

## Evaporator and room control, type EKE 400

Label ID <sup>(1)</sup>	Parameter name	Description and selection options	Min.	Max	Factory Setting	Decimals	Locked by Main switch Yes/No	Read	Password level to change/write	Modbus address	Read only (RO) / Read Write (RW)	Persistent Yes/No	Modbus function
D20	EPC ICM OD min	<b>Min OD for ICM in Evaporation pressure control</b>  <i>Unit: %</i>	0	100	0	0	Yes	Password level 1,2,3	3	3381	RW	Yes	3, 4 & 16
D21	EPC ICM OD max	<b>Max OD for ICM in Evaporation pressure control</b>  <i>Unit: %</i>	0	100	100	0	Yes	Password level 1,2,3	3	3382	RW	Yes	3, 4 & 16
D22	EPC CVE OD min	<b>Min Opening Degree for CVE in Evaporation pressure control</b>	0	90	0	0	Yes	Password level 1,2,3	3	3416	RW	Yes	3, 4 & 16
D23	EPC CVE OD max	<b>Max Opening Degree for CVE in Evaporation pressure control</b>	0	90	90	0	Yes	Password level 1,2,3	3	3417	RW	Yes	3, 4 & 16
D3B	WR/SL at Cool. stopped	<b>Status of Wet Return/Suction Line valve during cooling stopped</b>  Closed: WR/SL valve closed during Cooling <b>OBSERVE - assess risk of trapped liquid when WR/SL valve is closed during Cooling stopped</b> Open: WR/SL valve open during Cooling	0=closed	1=Open	1=Open	0	Yes	Password level 1,2,3	3	3323	RW	Yes	3, 4 & 16
D3D	WR/SL at Cool. stopped	<b>Status of Wet Return/Suction Line valve for WR/SL ctrl during cooling stopped</b>  0: Closed; Selected Valve in WR/SL valve;closed 1: Open; Selected Valve in WR/SL valve;open 2: user defined: Different options depending if ICM or CVE valve has been selected as valve in WR/SL. See parameters D3E,CVEsafe OD at stop D3FSuc.Pres.SP T at stop D3G,ICMsafe OD at stop	0	2	1	0	Yes	Password level 1,2,3	3	3447	RW	Yes	3, 4 & 16
D3E	CVEsafe OD at stop	<b>CVE OD when cooling is stopped</b>  Enter OD % of the CVE valve in the Wet Return valve, when in cooling stopped <i>Unit: %</i>	23	90	90	0	Yes	Password level 1,2,3	3	3440	RW	Yes	3, 4 & 16
D3F	Suc.Pres.SP T at stop	<b>Suction Pressure Setpoint in °C (°F) when cooling is stopped</b>  Suction pressure converted in saturation temperature with a motorized ICM valve in Wet Return line, controlling pressure, when cooling is Stopped <i>Unit: °C/ °F</i>	-90.0	60.0	-90.0	1	Yes	Password level 1,2,3	3	3441	RW	Yes	3, 4 & 16
D3G	ICMsafe OD at stop	<b>ICM OD when cooling is stopped</b>  Enter ICM OD % of the ICM valve in the Wet Return valve, when in cooling stopped <i>Unit: %</i>	0	100	100	0	Yes	Password level 1,2,3	3	3458	RW	Yes	3, 4 & 16
D3H	WR/SL valve AI feedback	<b>Wet Return/Suction Line valve feedback from ICAD on ICM valve In IO configuration</b>  In IO configuration \ Analog inputs the Analog input type can be selected. 0-10 V;0-20 mA;4-20 mA;2-10 V  No: ICAD not connected to EKE 400 Yes: ICAD connected to EKE 400	No	Yes	No	0	Yes	Password level 1,2,3	3	3452	RW	Yes	3, 4 & 16

## Evaporator and room control, type EKE 400

Label ID <sup>(1)</sup>	Parameter name	Description and selection options	Min.	Max	Factory Setting	Decimals	Locked by Main switch Yes/No	Read	Password level to change/write	Modbus address	Read only (RO) / Read Write (RW)	Persistent Yes/No	Modbus function
D4A	Drain solenoid?	<b>Decide if drain solenoid in defrost drain line is installed</b>  No Yes	0=No	1=Yes	1=Yes	0	Yes	Password level 1,2,3	3	3252	RW	Yes	3, 4 & 16
D4B	Quick Drain?	<b>Decide if drain valve is installed to drain liquid quickly out before hot gas enter evaporator</b>  No Yes	0=No	1=Yes	0=No	0	Yes	Password level 1,2,3	3	3254	RW	Yes	3, 4 & 16
D05	Cool at HG defrost	<b>Cool at Hot Gas defrost</b>  Typical when no PLC connected to coordinate defrost. See <a href="#">Appendix A</a> If defrost start is coordinated locally by EKE 400, it is possible to configure if EKE 400 shall go into forced cooling, when another EKE 400 in the same group is defrosting. Each EKE 400 in a group will broadcast the signal "Defrost sequence status" over CAN bus No: Function disable Yes: Function enabled	0=No	1=Yes	0=No	0	Yes	Password level 1,2,3	3	3082	RW	Yes	3, 4 & 16
D06	Defrost allowed	<b>Defrost allowed</b>  Typical with PLC connected via MODBUS, but defrost is handled by EKE 400. PLC to allow defrost to take place, typical only if Hot gas is available  No: Defrost not allowed from PLC (no Hot gas available) Yes: Defrost allowed from PLC (Hot gas is available)	0=No	1=Yes	1=Yes	0	No	Password level 1,2,3	2	3083	RW	Yes	3, 4 & 16
D07	Defrost allowed via DI	<b>Defrost allowed via DI</b>  Typical with PLC connected via DI, but defrost is handled by EKE 400. PLC to allow defrost to take place, typical only if Hot gas is available.  No: Function disable Yes: Function enabled OBSERVE require that "D07, Defrost allowed"="Yes" To assign DI, go to I/O configuration in Main menu and select an available DI. Set this DI to "Defrost allowed via DI"	0=No	1=Yes	0=No	0	Yes	Password level 1,2,3	3	3084	RW	Yes	3, 4 & 16

## Evaporator and room control, type EKE 400

Label ID <sup>(1)</sup>	Parameter name	Description and selection options	Min.	Max	Factory Setting	Decimals	Locked by Main switch Yes/No	Read	Password level to change/write	Modbus address	Read only (RO) / Read Write (RW)	Persistent Yes/No	Modbus function
D08	Def. seq. status on DO	<p><b>Def. seq. status on DO</b></p> <p>Select if an DO shall be synchronized with defrost seq. status (ON/OFF). The DO is set ON at defrost start and is set OFF when the complete defrost sequence is completed.</p> <p>No: Disabled Yes: Enabled To assign DO, go to I/O configuration in Main menu and select an available DO. Set this DO to "Def. seq. status on DO" DO=OFF: Defrost completed DO=ON: Defrost is underway</p>	0=No	1=Yes	0=No	0	Yes	Pass-word level 1,2,3	3	3085	RW	Yes	3, 4 & 16
D09	Water valve?	<p><b>Decide if Water valve is used</b></p> <p>This function adds control of a valve that enables water spray on the evaporator during hot gas defrosting. Helps to loosen ice on evaporator during defrost, by means of water (spay)</p> <p>No: Disabled Yes: Function enabled To assign DO, go to I/O configuration in Main menu and select an available DO.</p> <p>The water valve opens when the following two criteria are meet: The hot gas main valve is ON and the "D67, Water valve delay" limited has expired. When the Water valve is opened a timer starts defined in "D68,Water valve time". The Water valve closes when the timer reaches "D68,Water valve time" or when entering "D59, Drip off time". (See <a href="#">Figure 21: Defrost sequence</a>).</p>	0=No	1=Yes	0=No	0	Yes	Pass-word level 1,2,3	3	3325	RW	Yes	3, 4 & 16
D24	WR/SL soft at cooling	<p><b>WR/SL soft valve (EVRST) after WR/SL opening phase</b></p> <p>0: Closed 1: Open</p>	0	1	1	0	Yes	Pass-word level 1,2,3	3	3463	RW	Yes	3, 4 & 16

<sup>(1)</sup> Visibility depends on other parameter settings. Numbers are displayed in Metric units ( P01, Temperature units=MET).



## Defrost function \ Defrost start methods

**Table 13: Defrost function \ Defrost start methods**

Label ID <sup>(1)</sup>	Parameter name	Description and selection options	Min.	Max	Factory Setting	Unit	Decimals	Locke by Main switcl Yes/N	Read	Pass-word level to change/write	Mod-bus address	Read only (RO) / Read Write (RW)	Persis-tent Yes/No	Modbus function
D10	Man. def. start	<p><b>Manual defrost start</b></p> <p>A manual defrost start can be done (Forced defrost) - Can also be used from a PLC connected via MODBUS</p> <p>OFF: No forced defrost ON: Forced manual defrost</p>	0=OFF	1=ON	0=OFF		0	No	Pass-word level 1,2,3	2	3054	RW	No	3, 4 & 16
D11	Def. time interval	<p><b>Defrost start by time interval</b></p> <p>Fail safe function if another configured defrost start, has failed. A defrost will be started when the interval counter (real time) exceeds the 'Defrost time interval' setting. The interval counter is start counting from zero when the defrost is started. The interval counter will be reset at every defrost start. The interval counter shall be in stand-by (not counting) at "Main switch is OFF". Can be seen in Status Screen 1.</p> <p>If "D11,Def. time interval" is 0 (zero) the function is disabled" <i>Unit: hours</i></p>	0	240	0	hour	0	No	Pass-word level 1,2,3	2	3075	RW	Yes	3, 4 & 16
D12	Def. start acc. cool time	<p><b>Defrost start by accumulated cooling time</b></p> <p>Can also be used as a fail safe function if another configured defrost start, has failed. A defrost will be started when the accumulated cooling time exceeds "D12,Def. start acc. cool time" setting. The accumulated cooling time will be reset at every defrost start. <i>Unit: hours</i></p>	0	240	0	hour	0	No	Pass-word level 1,2,3	2	3076	RW	Yes	3, 4 & 16
D13	Time staggering	<p><b>Time staggered defrost</b></p> <p>Defrost will only be staggered after:</p> <ul style="list-style-type: none"> <li>- After power cut.</li> <li>- Start according to "D11,Def. time interval"</li> <li>- This means Start defrost after ["D11,Def. time interval" + "D13,Time staggering"]</li> <li>- Start according to "D12,Def. start acc. cool time" - This means Start defrost after ["D12,Def. start acc. cool time" + "D13,Time staggering"]</li> </ul> <p>Successive defrosts will be started when the time interval Defrost time interval or accumulated cooling time has elapsed" <i>Unit: min</i></p>	0	240	0	min	0	No	Pass-word level 1,2,3	2	3077	RW	Yes	3, 4 & 16
D14	Def. start by DI	<p><b>Defrost start by DI</b></p> <p>Option to start defrost via DI. Typical external signal from PLC or a push bottom. If function is enabled, a defrost is started when the DI changes from OFF to ON. Successive change of the DI during the defrost period are ignored.</p> <p>No: Function disable Yes: Function enabled</p>	0=No	1=Yes	0=No		0	Yes	Pass-word level 1,2,3	3	3055	RW	Yes	3, 4 & 16

## Evaporator and room control, type EKE 400

Label ID <sup>(1)</sup>	Parameter name	Description and selection options	Min.	Max	Factory Setting	Unit	Decimals	Locke by Main switcl Yes/N	Read	Pass-word level to change/write	Mod-bus address	Read only (RO) / Read Write (RW)	Persis-tent Yes/No	Modbus function
D15	Def. start schedule	<b>Defrost start schedule</b>  Option to run defrost according to local time scedules in EKE 400. Three schcdules possible (weekdays, saturdays and sunday) with 6 defrost start time each.  No: Function disable Yes: Function enabled	0=No	1=Yes	0=No		0	No	Pass-word level 1,2,3	3	3056	RW	Yes	3, 4 & 16
DA1	Def. 1 sch.MON-DAY	Defrost start time for MONDAY	0=00:00	1439=23:59	0=00:00		0	No	Pass-word level 1,2,3	2	3277	RW	Yes	3, 4 & 16
DA2	Def. 2 sch.MON-DAY	Defrost start time for MONDAY	0=00:00	1439=23:59	0=00:00		0	No	Pass-word level 1,2,3	2	3278	RW	Yes	3, 4 & 16
DA3	Def. 3 sch.MON-DAY	Defrost start time for MONDAY	0=00:00	1439=23:59	0=00:00		0	No	Pass-word level 1,2,3	2	3279	RW	Yes	3, 4 & 16
DA4	Def. 4 sch.MON-DAY	Defrost start time for MONDAY	0=00:00	1439=23:59	0=00:00		0	No	Pass-word level 1,2,3	2	3280	RW	Yes	3, 4 & 16
DA5	Def. 5 sch.MON-DAY	Defrost start time for MONDAY	0=00:00	1439=23:59	0=00:00		0	No	Pass-word level 1,2,3	2	3281	RW	Yes	3, 4 & 16
DA6	Def. 6 sch.MON-DAY	Defrost start time for MONDAY	0=00:00	1439=23:59	0=00:00		0	No	Pass-word level 1,2,3	2	3282	RW	Yes	3, 4 & 16
DX1	Copy MONDAY to:	<b>Copy MONDAY schedules</b>  Copy MONDAY to other day or week days or all days: 0 = MONDAY 1 = TUESDAY 2 = WEDNESDAY 3 = THURSDAY 4 = FRIDAY 5 = SATURDAY 6 = SUNDAY 7 = week days 8 = all days	0	8	0=MON-DAY		0	No	Pass-word level 1,2,3	2	3324	RW	Yes	3, 4 & 16
DB1	Def. 1 sch.TUES-DAY	Defrost start time for TUESDAY	0=00:00	1439=23:59	0=00:00		0	No	Pass-word level 1,2,3	2	3283	RW	Yes	3, 4 & 16
DB2	Def. 2 sch.TUES-DAY	Defrost start time for TUESDAY	0=00:00	1439=23:59	0=00:00		0	No	Pass-word level 1,2,3	2	3284	RW	Yes	3, 4 & 16
DB3	Def. 3 sch.TUES-DAY	Defrost start time for TUESDAY	0=00:00	1439=23:59	0=00:00		0	No	Pass-word level 1,2,3	2	3285	RW	Yes	3, 4 & 16
DB4	Def. 4 sch.TUES-DAY	Defrost start time for TUESDAY	0=00:00	1439=23:59	0=00:00		0	No	Pass-word level 1,2,3	2	3286	RW	Yes	3, 4 & 16
DB5	Def. 5 sch.TUES-DAY	Defrost start time for TUESDAY	0=00:00	1439=23:59	0=00:00		0	No	Pass-word level 1,2,3	2	3287	RW	Yes	3, 4 & 16
DB6	Def. 6 sch.TUES-DAY	Defrost start time for TUESDAY	0=00:00	1439=23:59	0=00:00		0	No	Pass-word level 1,2,3	2	3288	RW	Yes	3, 4 & 16

## Evaporator and room control, type EKE 400

Label ID <sup>(1)</sup>	Parameter name	Description and selection options	Min.	Max	Factory Setting	Unit	Deci- mals	Locke by Main switcl Yes/N	Read	Pass- word level to change/ write	Mod- bus ad- dress	Read only (RO) / Read Write (RW)	Persis- tent Yes/No	Modbus function
DC1	Def. 1 sch.WED- NESDAY	Defrost start time for WEDNESDAY	0= 00:00	1439= 23:59	0=00:00		0	No	Pass- word level 1,2,3	2	3289	RW	Yes	3, 4 & 16
DC2	Def. 2 sch.WED- NESDAY	Defrost start time for WEDNESDAY	0= 00:00	1439= 23:59	0=00:00		0	No	Pass- word level 1,2,3	2	3290	RW	Yes	3, 4 & 16
DC3	Def. 3 sch.WED- NESDAY	Defrost start time for WEDNESDAY	0= 00:00	1439= 23:59	0=00:00		0	No	Pass- word level 1,2,3	2	3291	RW	Yes	3, 4 & 16
DC4	Def. 4 sch.WED- NESDAY	Defrost start time for WEDNESDAY	0= 00:00	1439= 23:59	0=00:00		0	No	Pass- word level 1,2,3	2	3292	RW	Yes	3, 4 & 16
DC5	Def. 5 sch.WED- NESDAY	Defrost start time for WEDNESDAY	0= 00:00	1439= 23:59	0=00:00		0	No	Pass- word level 1,2,3	2	3293	RW	Yes	3, 4 & 16
DC6	Def. 6 sch.WED- NESDAY	Defrost start time for WEDNESDAY	0= 00:00	1439= 23:59	0=00:00		0	No	Pass- word level 1,2,3	2	3294	RW	Yes	3, 4 & 16
DD1	Def. 1 sch. THURSDAY	Defrost start time for THURSDAY	0= 00:00	1439= 23:59	0=00:00		0	No	Pass- word level 1,2,3	2	3295	RW	Yes	3, 4 & 16
DD2	Def. 2 sch. THURSDAY	Defrost start time for THURSDAY	0= 00:00	1439= 23:59	0=00:00		0	No	Pass- word level 1,2,3	2	3296	RW	Yes	3, 4 & 16
DD3	Def. 3 sch. THURSDAY	Defrost start time for THURSDAY	0= 00:00	1439= 23:59	0=00:00		0	No	Pass- word level 1,2,3	2	3297	RW	Yes	3, 4 & 16
DD4	Def. 4 sch. THURSDAY	Defrost start time for THURSDAY	0= 00:00	1439= 23:59	0=00:00		0	No	Pass- word level 1,2,3	2	3298	RW	Yes	3, 4 & 16
DD5	Def. 5 sch. THURSDAY	Defrost start time for THURSDAY	0= 00:00	1439= 23:59	0=00:00		0	No	Pass- word level 1,2,3	2	3299	RW	Yes	3, 4 & 16
DD6	Def. 6 sch. THURSDAY	Defrost start time for THURSDAY	0= 00:00	1439= 23:59	0=00:00		0	No	Pass- word level 1,2,3	2	3300	RW	Yes	3, 4 & 16
DE1	Def. 1 sch.FRIDAY	Defrost start time for FRIDAY	0= 00:00	1439= 23:59	0=00:00		0	No	Pass- word level 1,2,3	2	3301	RW	Yes	3, 4 & 16
DE2	Def. 2 sch.FRIDAY	Defrost start time for FRIDAY	0= 00:00	1439= 23:59	0=00:00		0	No	Pass- word level 1,2,3	2	3302	RW	Yes	3, 4 & 16
DE3	Def. 3 sch.FRIDAY	Defrost start time for FRIDAY	0= 00:00	1439= 23:59	0=00:00		0	No	Pass- word level 1,2,3	2	3303	RW	Yes	3, 4 & 16
DE4	Def. 4 sch.FRIDAY	Defrost start time for FRIDAY	0= 00:00	1439= 23:59	0=00:00		0	No	Pass- word level 1,2,3	2	3304	RW	Yes	3, 4 & 16
DE5	Def. 5 sch.FRIDAY	Defrost start time for FRIDAY	0= 00:00	1439= 23:59	0=00:00		0	No	Pass- word level 1,2,3	2	3305	RW	Yes	3, 4 & 16

## Evaporator and room control, type EKE 400

Label ID <sup>(1)</sup>	Parameter name	Description and selection options	Min.	Max	Factory Setting	Unit	Decimals	Locke by Main switcl Yes/N	Read	Pass-word level to change/write	Mod-bus address	Read only (RO) / Read Write (RW)	Persis-tent Yes/No	Modbus function
DE6	Def. 6 sch.FRIDAY	Defrost start time for FRIDAY	0=00:00	1439=23:59	0=00:00		0	No	Pass-word level 1,2,3	2	3306	RW	Yes	3, 4 & 16
DF1	Def. 1 sch.SATURDAY	Defrost start time for SATURDAY	0=00:00	1439=23:59	0=00:00		0	No	Pass-word level 1,2,3	2	3307	RW	Yes	3, 4 & 16
DF2	Def. 2 sch.SATURDAY	Defrost start time for SATURDAY	0=00:00	1439=23:59	0=00:00		0	No	Pass-word level 1,2,3	2	3308	RW	Yes	3, 4 & 16
DF3	Def. 3 sch.SATURDAY	Defrost start time for SATURDAY	0=00:00	1439=23:59	0=00:00		0	No	Pass-word level 1,2,3	2	3309	RW	Yes	3, 4 & 16
DF4	Def. 4 sch.SATURDAY	Defrost start time for SATURDAY	0=00:00	1439=23:59	0=00:00		0	No	Pass-word level 1,2,3	2	3310	RW	Yes	3, 4 & 16
DF5	Def. 5 sch.SATURDAY	Defrost start time for SATURDAY	0=00:00	1439=23:59	0=00:00		0	No	Pass-word level 1,2,3	2	3311	RW	Yes	3, 4 & 16
DF6	Def. 6 sch.SATURDAY	Defrost start time for SATURDAY	0=00:00	1439=23:59	0=00:00		0	No	Pass-word level 1,2,3	2	3312	RW	Yes	3, 4 & 16
DG1	Def. 1 sch.SUNDAY	Defrost start time for SUNDAY	0=00:00	1439=23:59	0=00:00		0	No	Pass-word level 1,2,3	2	3313	RW	Yes	3, 4 & 16
DG2	Def. 2 sch.SUNDAY	Defrost start time for SUNDAY	0=00:00	1439=23:59	0=00:00		0	No	Pass-word level 1,2,3	2	3314	RW	Yes	3, 4 & 16
DG3	Def. 3 sch.SUNDAY	Defrost start time for SUNDAY	0=00:00	1439=23:59	0=00:00		0	No	Pass-word level 1,2,3	2	3315	RW	Yes	3, 4 & 16
DG4	Def. 4 sch.SUNDAY	Defrost start time for SUNDAY	0=00:00	1439=23:59	0=00:00		0	No	Pass-word level 1,2,3	2	3316	RW	Yes	3, 4 & 16
DG5	Def. 5 sch.SUNDAY	Defrost start time for SUNDAY	0=00:00	1439=23:59	0=00:00		0	No	Pass-word level 1,2,3	2	3317	RW	Yes	3, 4 & 16
DG6	Def. 6 sch.SUNDAY	Defrost start time for SUNDAY	0=00:00	1439=23:59	0=00:00		0	No	Pass-word level 1,2,3	2	3318	RW	Yes	3, 4 & 16

<sup>(1)</sup> Visibility depends on other parameter settings. Numbers are displayed in Metric units ( P01, Temperature units=MET).

## Defrost function \ Defrost stop methods

**Table 14: Defrost function \ Defrost stop methods**

Label ID <sup>(1)</sup>	Parameter name	Description and selection options	Min.	Max	Factory Setting	Decimals	Locked by Main switch Yes/No	Read	Password level to change/write	Modbus address	Read only (RO) / Read Write (RW)	Persistent Yes/No	Modbus function
D40	Defrost stop method	<p><b>Defrost stop method</b></p> <p>Select method for stop of defrost</p> <p>1:Stop on time: When the time delay "D58,Max defrost time" expires, the defrost is terminated</p> <p>2:Stop on temp: When the defrost sensor temperature becomes greater than the set point "D43,Def. stop temp. limit", then the defrost is terminated. If the defrost time exceed "D58,Max defrost time", then the alarm 'Max defrost time' is send and the defrost is terminated. In case of sensor error, and the time 'Max defrost time' expires, the alarm 'Max defrost time' is send and the defrost is terminated. The alarm will automatically be reset after 5 minutes. To assign defrost sensor temperature, go to I/O configuration in Main menu and select an available AI.</p>	1	2	1=Stop on time	0	Yes	Pass-word level 1,2,3	3	3078	RW	Yes	3, 4 & 16
D41	Man. defrost stop	<p><b>Manual defrost stop</b></p> <p>Option to, local on EKE 400, to stop defrost. Can also be used from a PLC connected via MODBUS</p> <p>No: Function disable Yes: Function enabled - Observe. All states (See <a href="#">Figure 21: Defrost sequence</a>) before and after Defrost sequence state: "Defrost state" will be still be executed ("Defrost state" will be ignored/supressed).</p> <p>When defrost is completed, "D41, Man. defrost stop" will automatically be set back to "No".</p>	0=No	1=Yes	0=No	0	No	Pass-word level 1,2,3	2	3079	RW	No	3, 4 & 16
D42	Defrost stop via DI	<p><b>Defrost stop via DI</b></p> <p>Forced stop defrost via external equipment (e.g. PLC) to EKE 400, via DI</p> <p>No: Function disable Yes: Function enabled- Observe. All states (See <a href="#">Figure 21: Defrost sequence</a>) before and after Defrost sequence state: "Defrost state" will be still be executed ("Defrost state" will be ignored/supressed)</p> <p>To assign DI, go to I/O configuration in Main menu and select an available DI"</p>	0=No	1=Yes	0=No	0	Yes	Pass-word level 1,2,3	3	3080	RW	Yes	3, 4 & 16
D43	Def. stop temp. limit	<p><b>Defrost stop temperature limit</b></p> <p>See "D40, Defrost stop method" Unit: °C / °F</p>	0	25	8	1	No	Pass-word level 1,2,3	2	3081	RW	Yes	3, 4 & 16

<sup>(1)</sup> Visibility depends on other parameter settings. Numbers are displayed in Metric units ( P01, Temperature units=MET).

## Defrost function \ Defrost sequence

**Table 15: Defrost function \ Defrost sequence**

Label ID <sup>(1)</sup>	Parameter name	Description and selection options	Min.	Max	Factory Setting	Decimals	Locked by Main switch Yes/No	Read	Password level to change/write	Modbus address	Read only (RO) / Read Write (RW)	Persistent Yes/No	Modbus function
D50	Pump down delay	<b>Pump down delay</b> Draining the evaporator before defrosting. Always active The pump down state is used to empty the evaporator for liquid See <a href="#">Figure 21: Defrost sequence</a> Unit: min	1	30	10	0	No	Pass-word level 1,2,3	2	3086	RW	Yes	3, 4 & 16
D51	HG open delay	<b>Hot Gas open delay</b> Time delay in minutes before opening the hot gas valve (delay for valve in the wet return line to close) See <a href="#">Figure 21: Defrost sequence</a> Unit: min	1	10	5	0	No	Pass-word level 1,2,3	2	3087	RW	Yes	3, 4 & 16
D5A	Drip tray pre-heat	<b>Drip tray pre-heat</b> Pre-heating time for hot gas to drip tray See <a href="#">Figure 21: Defrost sequence</a> Unit: min	0	20	5	0	No	Pass-word level 1,2,3	2	3256	RW	Yes	3, 4 & 16
D5B	Drip tray delay OFF	<b>Drip tray delay OFF</b> Continue drip tray heating some defined time See <a href="#">Figure 21: Defrost sequence</a> Unit: min	0	120	30	0	No	Pass-word level 1,2,3	2	3257	RW	Yes	3, 4 & 16
D53	HG soft time	<b>Hot gas soft time</b> Time between step 1 and step 2 for opening the hot gas valve (2 DO used) See <a href="#">Figure 21: Defrost sequence</a> Unit: min	1	30	3	0	No	Pass-word level 1,2,3	2	3098	RW	Yes	3, 4 & 16
D54	HG time step 1	<b>Hot Gas time step 1</b> ICM Motorvalve: Step 1 time controlled opening to "D55, HG OD step 1" See <a href="#">Figure 21: Defrost sequence</a> Unit: min	0	30	3	0	No	Pass-word level 1,2,3	2	3099	RW	Yes	3, 4 & 16
D55	HG OD step 1	<b>Hot Gas valve Opening Degree step 1</b> ICM Motorvalve: Valve opening from 0% to "D55, HG OD step 1" inside "D54,HG time step 1" time. See <a href="#">Figure 21: Defrost sequence</a> Unit: %	0	100	20	0	No	Pass-word level 1,2,3	2	3100	RW	Yes	3, 4 & 16
D56	HG time step 2	<b>Hot Gas time step 2</b> ICM Motorvalve: Controlled opening in step 2 See <a href="#">Figure 21: Defrost sequence</a> Unit: min	1	30	2	0	No	Pass-word level 1,2,3	2	3101	RW	Yes	3, 4 & 16
D57	Quick drain time	<b>Quick drain time</b> Require that Quick Drain is selected. (D4B,Quick Drain?=Yes) Enter how long time the Quick Drain valve stays open. Quick Drain valve will start opening together with Hot gas valve. See <a href="#">Figure 21: Defrost sequence</a> Unit: sec	1	300	30	0	No	Pass-word level 1,2,3	2	3102	RW	Yes	3, 4 & 16
D58	Max defrost time	<b>Max defrost time</b> Max. allowed defrost duration in minutes Unit: min	1	120	30	0	No	Pass-word level 1,2,3	2	3089	RW	Yes	3, 4 & 16

## Evaporator and room control, type EKE 400

Label ID <sup>(1)</sup>	Parameter name	Description and selection options	Min.	Max	Factory Setting	Decimals	Locked by Main switch Yes/No	Read	Password level to change/write	Modbus address	Read only (RO) / Read Write (RW)	Persistent Yes/No	Modbus function
D5C	HG close delay	<b>Hot Gas close delay</b> Require a soft opening valve in the Hot Gas Line (D2A, Hot gas line valve=Soft (ICS+EVRST) or Soft (ICSH) or Slow (ICM)). Delay before closing the selected valves in the Hot gas line. See <a href="#">Figure 21: Defrost sequence</a> Unit: sec	0	120	15	0	No	Password level 1,2,3	2	3258	RW	Yes	3, 4 & 16
D5D	Drain close delay	<b>Drain close delay</b> Require that Drain Valve is selected (D4A, Drain solenoid?=Yes). Delay before the Drain valve is closed See <a href="#">Figure 21: Defrost sequence</a> Unit: min	0	10	2	0	No	Password level 1,2,3	2	3259	RW	Yes	3, 4 & 16
D59	Drip off time	<b>Drip off time</b> Allow water on the evaporator to drip off. See <a href="#">Figure 21: Defrost sequence</a> Unit: min	1	15	5	0	No	Password level 1,2,3	2	3090	RW	Yes	3, 4 & 16
D72	WR valve AI feedback	<b>Drain and Quick Drain equalizing time after Drip Off</b> If time is set to 0 (zero), the Drain Equalizing state is not in use and quick drain valve will stay closed See <a href="#">Figure 21: Defrost sequence</a> Unit: sec	0	360	30	0	Yes	Password level 1,2,3	2	3464	RW	Yes	3, 4 & 16
D61	WR/SL soft time	<b>Wet Return/Suction Line valve soft time</b> Time between step 1 and step 2 for opening the Wet Return/Suction Line valve ("Soft (ICS+EVRST)" or "Soft (ICSH)). See <a href="#">Figure 21: Defrost sequence</a> Unit: min	1	30	2	0	No	Password level 1,2,3	2	3094	RW	Yes	3, 4 & 16
D6A	WR/SL main time	<b>Wet Return/Suction Line valve main time</b> After defrost and wet return valve has opened (main), enter delay before valve in liquid line to open. See <a href="#">Figure 21: Defrost sequence</a> Unit: min	1	30	2	0	No	Password level 1,2,3	2	3260	RW	Yes	3, 4 & 16
D62	WR/SL time step 1	<b>Wet Return/Suction Line valve time step 1</b> ICM Motorvalve: Step 1 controlled opening to D63, WR/SL OD step 1 See <a href="#">Figure 21: Defrost sequence</a> Unit: min	0	30	3	0	No	Password level 1,2,3	2	3095	RW	Yes	3, 4 & 16
D63	WR/SL OD step 1	<b>Wet Return/Suction Line valve Opening Degree step 1</b> ICM Motorvalve: Valve opening from 0% to "D63,WR/SL OD step 1" inside "D62,WR/SL time step 1" time See <a href="#">Figure 21: Defrost sequence</a> Unit: %	0	100	20	0	No	Password level 1,2,3	2	3096	RW	Yes	3, 4 & 16
D64	WR/SL time step 2	<b>Wet Return/Suction Line valve time step 2</b> ICM motorvalve opening step 2 time See <a href="#">Figure 21: Defrost sequence</a> Unit: min	1	30	2	0	No	Password level 1,2,3	2	3097	RW	Yes	3, 4 & 16
D70	Time avg CVE OD	<b>Time over to calcute the average value of CVE OD%</b> During the cooling, an average OD of CVE is calculated continuously. The time window of the average is defined by D70 Unit: min	0	120	30	0	Yes	Password level 1,2,3	2	3438	RW	Yes	3, 4 & 16

## Evaporator and room control, type EKE 400

Label ID <sup>(1)</sup>	Parameter name	Description and selection options	Min.	Max	Factory Setting	Decimals	Locked by Main switch Yes/No	Read	Password level to change/write	Modbus address	Read only (RO) / Read Write (RW)	Persistent Yes/No	Modbus function
D71	Time restore CVE OD	<b>Time to maintain the CVE OD average value after defrost</b>  When entering "Fan delay state", CVE keeps operating at the average OD for a period of time defined by D71 before the regulation starts <i>Unit: min</i>	0	120	10	0	Yes	Password level 1,2,3	2	3439	RW	Yes	3, 4 & 16
D65	Fan start delay	<b>Fan start delay</b>  Delay before start of fans. Liquid Line valve is ON, in this state. See <a href="#">Figure 21: Defrost sequence</a> <i>Unit: min</i>	0	30	2	0	No	Password level 1,2,3	2	3092	RW	Yes	3, 4 & 16
D66	Fan ctrl. at defrost	<b>Fan control at defrost</b>  Define if fans shall run or be stopped during the defrost sequence.  No: Fans are stopped Yes: Fans are running See <a href="#">Figure 21: Defrost sequence</a>	0=No	1=Yes	0=No	0	No	Password level 1,2,3	3	3093	RW	Yes	3, 4 & 16
D67	Water valve delay	<b>Delay before start of Water valve</b>  See "D09, Water valve?" Description <i>Unit: min</i>	0	240	15	0	No	Password level 1,2,3	2	3334	RW	Yes	3, 4 & 16
D68	Water valve time	<b>Time on of Water valve</b>  See "D09, Water valve?" Description <i>Unit: min</i>	1	120	15	0	No	Password level 1,2,3	2	3335	RW	Yes	3, 4 & 16
D69	WR/SL Pr. Equalising	<b>Wet Return/Suction Line Pressure Equalising time</b>  Equalizing pressure in evaporator by soft opening wet return line valve. Carefully emptying the evaporator for hot gas via a little drain valve (by-pass valve) in the wet return line or soft opening of wet return valve. <i>Unit: min</i>	1	10	5	0	X	Password level 1,2,3	2	3414	RW	Yes	3, 4 & 16

<sup>(1)</sup> Visibility depends on other parameter settings. Numbers are displayed in Metric units ( P01, Temperature units=MET).



## Fan control

**Table 16: Fan control**

Label ID <sup>(1)</sup>	Parameter name	Description and selection options	Min.	Max	Factory Setting	Decimals	Locked by Main switch Yes/No	Read	Password level to change/write	Modbus address	Read only (RO) / Read Write (RW)	Persistent Yes/No	Modbus function
F01	Fan control mode	<p><b>Fan control mode</b></p> <p>1: ON-OFF control: (1 DO) The fans are Off when cooling is stopped, and fans are On when cooling is ON</p> <p>2: ON Control: Fans are ON, also when cooling is stopped.</p> <p>3: Two step control: (2 DO): The two DO are controlled as below: Cooling Thermostat=ON DO1: ON DO2: OFF Cooling Thermostat=OFF DO1: ON DO2: ON</p> <p>8: On-Off ctrl cycling. During cooling OFF, Fan switches between ON and OF, defined by parameter F06,Cycling OFF time and F07,Cycling ON time. Used when air circulation is required during OFF periods of the thermostat. In normal cooling operation the fan is ON and should not follow the thermostat.</p> <p>4: 0-10 V EC fan ctrl: (1 AO), Modulating control via AO See "F02,Fan speed high" and "F03,Fan speed low"</p> <p>5: 0-10 V EC fan ctrl: (1 AO, 1 DO), Modulating control via AO and DO Same as "F01, Fan control mode =4 plus the DO should be ON when AO has to be larger than 0% and OFF whenever AO is zero (0%)</p> <p>6: 0-10 VFD variable (1AO): See <a href="#">Figure 23: VFD speed</a> The VFD speed control could follow proportional band, linked to four parameters F03, Fan speed low F02, Fan speed high F04, Offset speed low F05, Offset speed high</p> <p>7: 0-10 VFD var.+DO (1AO + 1DO). Same (6:0-10 VFD variable (1AO)), but with an added DO assignment.The DO should be ON when AO &gt; 0 and OFF whenever AO is 0 (zero) 0: No control: No control of fans</p>	0	8	1=On-Off control	0	Yes	Password level 1,2,3	3	3103	RW	Yes	3, 4 & 16
F02	Fan speed high	<p><b>Fan speed high</b></p> <p>Setting for Fan control via AO - High speed Enter Fan speed high in percent in Cooling mode. 100 % equals max. Speed / Maximum AO output of 10 V Unit: %</p>	0	100	100	0	No	Password level 1,2,3	2	3104	RW	Yes	3, 4 & 16
F03	Fan speed low	<p><b>Fan speed low</b></p> <p>Setting for Fan control via AO - High speed Enter Fan speed low in percent when not in Cooling mode. 100 % equals max. Speed / Maximum AO output of 10 V Unit: %</p>	0	100	50	0	No	Password level 1,2,3	2	3105	RW	Yes	3, 4 & 16

## Evaporator and room control, type EKE 400

Label ID <sup>(1)</sup>	Parameter name	Description and selection options	Min.	Max	Factory Setting	Decimals	Locked by Main switch Yes/No	Read	Password level to change/write	Modbus address	Read only (RO) / Read Write (RW)	Persistent Yes/No	Modbus function
F04	Offset speed low	<b>Offset speed low</b> Offset to roomtemperature setpoint at low speed. See F01, Fan control mode description <i>Unit: K</i>	-20.0	20.0	0.0	1	No	Password level 1,2,3	3	3459	RW	Yes	3, 4 & 16
F05	Offset speed high	<b>Offset speed high</b> Offset to roomtemperature setpoint at high speed. See F01, Fan control mode description <i>Unit: K</i>	-20.0	20.0	0.0	1	No	Password level 1,2,3	3	3460	RW	Yes	3, 4 & 16
F06	Cycling OFF time	<b>Cycling OFF time</b> During cooling OFF, Fan switches between ON and OFF, defined by parameters: F06, Cycling OFF time F07, Cycling ON time <i>Unit: min</i>	1	120	5	0	No	Password level 1,2,3	3	3461	RW	Yes	3, 4 & 16
F07	Cycling ON time	<b>Cycling ON time</b> During cooling OFF, Fan switches between ON and OFF, defined by parameters: F06, Cycling OFF time F07, Cycling ON time <i>Unit: min</i>	1	120	5	0	No	Password level 1,2,3	3	3462	RW	Yes	3, 4 & 16
F08	Fan on when DI forced closed	<b>Set whether fan should be on when forced closed from DI is activated</b> 0: No 1: Yes	No	Yes	No	0	Yes	Password level 1,2,3	3	3513	RW	Yes	3, 4 & 16
F09	Monitor fan DI alarm	<b>Monitor whether Fan is running</b> 0: No 1: Yes	No	Yes	No	0	Yes	Password level 1,2,3	0	3515	RW	Yes	3, 4 & 16
F10	Fan DI status	<b>Status for Fan DI</b> If F09, Monitor fan DI alarm is selected	Off	On	Off	0	Yes	Password level 1,2,3	0	3516	RO		3, 4 & 16

<sup>(1)</sup> Visibility depends on other parameter settings. Numbers are displayed in Metric units ( P01, Temperature units=MET).

## Reheat

Table 17: Reheat

Label ID <sup>(1)</sup>	Parameter name	Description and selection options	Min.	Max	Factory Setting	Decimals	Locked by Main switch Yes/No	Read	Password level to change/write	Modbus address	Read only (RO) / Read Write (RW)	Persistent Yes/No	Modbus function
RH0	Reheat enable?	<p><b>Enable Reheat function</b></p> <p>See <a href="#">Figure 24: Reheat function</a> Reheat function can manage to control humidity in room. The evaporator will continue to dehumidify the air and the re-heat coil will heat the air to keep the room from getting too cold while trying to reduce humidity</p> <p>No: Disable Reheat Function Yes: Enable Reheat Function. This means that 1 DO and 2 AI is assigned. Go to In IO configuration \ Analog and Digital Output inputs to assign: DO:Assign a solenoid valve.Select "Re-heat Sol" to an available DO AI: Assign a 4-20 mA Humidity sensor Select "Humidity sens." to an available AI</p>	No	Yes	No	0	Yes	Pass-word level 1,2,3	3	3465	RW	Yes	3, 4 & 16
RH1	Setpoint RH %	<p><b>Setpoint Humidity</b></p> <p>If RH0, Reheat enable?=Yes, then enter the Humidity Setpoint Unit: %</p>	0.0	100.0	50.0	1	Yes	Pass-word level 1,2,3	3	3466	RW	Yes	3, 4 & 16

<sup>(1)</sup> Visibility depends on other parameter settings. Numbers are displayed in Metric units ( P01, Temperature units=MET).

## Miscellaneous

Table 18: Miscellaneous

Label ID <sup>(1)</sup>	Parameter name	Description and selection options	Min.	Max	Factory Setting	Decimals	Locked by Main switch Yes/No	Read	Password level to change/write	Modbus address	Read only (RO) / Read Write (RW)	Persistent Yes/No	Modbus function
P01	Display unit	<p><b>Display unit</b></p> <p>0:MET: Metric units - Celsius (°C) and Kelvin (°K) 1:IMP: Imperial units - Fahrenheit (°F) and Rankine (°R)</p>	0	1	0=MET	0	No	Pass-word level 1,2,3	2	3115	RW	Yes	3, 4 & 16
P02	Alarm output	<p><b>Alarm output</b></p> <p>An alarm relay output can be configured, which will be activated in the event of an alarm. Select the alarm priority that will activate the relay. See Alarm priorities in Main Menu 0: No relay 1: Critical alarms: - To assign DO, go to I/O configuration in Main menu and select an available DO 2: Severe alarms - To assign DO, go to I/O configuration in Main menu and select an available DO 3: All alarms - To assign DO, go to I/O configuration in Main menu and select an available DO</p>	0	3	0=No relay	0	Yes	Pass-word level 1,2,3	3	3116	RW	Yes	3, 4 & 16
cAB	Buzzer Management	<p><b>Buzzer Management</b></p> <p>Select whic group of alarms that will activate the buzzer. 0: No buzzer 1: Critical alarms 2: Severe alarms 3: All alarms</p>	0	3	0=No buzzer	0	Yes	Pass-word level 1,2,3	3	3274	RW	Yes	3, 4 & 16

## Evaporator and room control, type EKE 400

Label ID <sup>(1)</sup>	Parameter name	Description and selection options	Min.	Max	Factory Setting	Decimals	Locked by Main switch Yes/No	Read	Password level to change/write	Modbus address	Read only (RO) / Read Write (RW)	Persistent Yes/No	Modbus function
P03	Main switch via DI	<p><b>Mainswitch via DI</b></p> <p>Release EKE 400 for operation or force EKE 400 out of operation via external equipment (e.g. PLC), via DI</p> <p>OFF: EKE 400 is forced out of operation. Observe if "M01,Main switch" is ON, this parameter will also when OFF, force EKE 400 out of operation</p> <p>ON: EKE 400 released for operation. Observe if "M01,Main switch" is ON, this parameter must also be ON, to release EKE 400 for operation</p>	0=No	1=Yes	0=No	0	Yes	Password level 1,2,3	3	3117	RW	Yes	3, 4 & 16
P10	Ext ref. config.	<p><b>External reference configuration</b></p> <p>Select the signal used to change the thermostat- or Media temp. reference.</p> <p>0: Not used</p> <p>1: Displace by current: - define the AI input range via the following settings:</p> <ul style="list-style-type: none"> <li>"P13,Ref. current high": 4 to 20 mA, default = 20</li> <li>"P14,Ref. current low": 0 to 20 mA, default = 4</li> </ul> <p>To assign AO, go to I/O configuration in Main menu and select an available AO.</p> <p>2: Displace by voltage: - define the AI input range via the following settings:</p> <ul style="list-style-type: none"> <li>"P15,Ref. voltage high": 0 to 10 Volt, default = 10</li> <li>"P16, Ref. voltage low": 0 to 10 Volt, default = 0</li> </ul> <p>To assign AO, go to I/O configuration in Main menu and select an available AO.</p> <p>3: Displace by modbus</p> <p>4: Displace by DI</p>	0	4	0=Not used	0	Yes	Password level 1,2,3	3	3118	RW	Yes	3, 4 & 16
P11	Ref. offset max	<p><b>Reference offset maximum</b></p> <p>Scaling of range for temperature displacement - Maximum value See "P10, Ext ref. config."</p> <p>Unit: °C / °F</p>	0.0	50.0	0.0	1	No	Password level 1,2,3	3	3119	RW	Yes	3, 4 & 16
P12	Ref. offset min	<p><b>Reference offset minimum</b></p> <p>Scaling of range for temperature displacement - Minimum value See "P10,Ext ref. config."</p> <p>Unit: °C / °F</p>	-70.0	0.0	0.0	1	No	Password level 1,2,3	3	3120	RW	Yes	3, 4 & 16
P13	Ref. current high	<p><b>Reference current high</b></p> <p>Scaling of range for AI current - high value See "P10, Ext ref. config."</p> <p>Unit: mA</p>	P14	20.0	20.0	1	No	Password level 1,2,3	3	3121	RW	Yes	3, 4 & 16
P14	Ref. current low	<p><b>Reference current low</b></p> <p>Scaling of range for AI current - low value See "P10,Ext ref. config."</p> <p>Unit: mA</p>	0.0	P13	4.0	1	No	Password level 1,2,3	3	3122	RW	Yes	3, 4 & 16
P15	Ref. voltage high	<p><b>Reference voltage high</b></p> <p>Scaling of range for AI voltage - high value See "P10,Ext ref. config."</p> <p>Unit: V</p>	P16	10.0	10.0	1	No	Password level 1,2,3	3	3123	RW	Yes	3, 4 & 16
P16	Ref. voltage low	<p><b>Reference voltage low</b></p> <p>Scaling of range for AI voltage - low value See "P10,Ext ref. config."</p> <p>Unit: V</p>	0.0	P15	0.0	1	No	Password level 1,2,3	3	3124	RW	Yes	3, 4 & 16

## Evaporator and room control, type EKE 400

Label ID <sup>(1)</sup>	Parameter name	Description and selection options	Min.	Max	Factory Setting	Decimals	Locked by Main switch Yes/No	Read	Password level to change/write	Modbus address	Read only (RO) / Read Write (RW)	Persistent Yes/No	Modbus function
P17	Lowpass bandwidth	<b>Lowpass bandwidth</b> The analog input signal selected in "P10,Ext ref. config." can be filtered. Contact Danfoss for further information 0: None 1: 4 Hz 2: 2 Hz 3: 1 Hz 4: 0.5 Hz 5: 0.2 Hz Unit: Hz	0.0	5.0	5=0.2	0	No	Pass-word level 1,2,3	3	3125	RW	Yes	3, 4 & 16
P18	Ref. offset by modbus	<b>Reference offset by MODBUS</b> Offset value via MODBUS (e.g. PLC) added to "T04, Ther. setpoint" Unit: °C/°F	-70.0	50.0	0.0	1	No	Pass-word level 1,2,3	3	3126	RW	Yes	3, 4 & 16
P19	Ref. offset by DI	<b>Reference OFFset by DI</b> An offset can be added to the T04, Thermostat set point temperature if P10, Ext ref. config.=Displace by DI Unit:K	-70.0	50.0	0.0	1	No	Pass-word level 1,2,3	3	3469	RW	Yes	3, 4 & 16
P25	Gas Conc.tra. AI?	<b>Gas Concentration Analog Input</b>	No	Yes	No	0	Yes	Pass-word level 1,2,3	3	3326	RW	Yes	3, 4 & 16

<sup>(1)</sup> Visibility depends on other parameter settings. Numbers are displayed in Metric units ( P01, Temperature units=MET).

## Miscellaneous (P22,P21,P2A,P23,P24 below all related to Emergency cooling sensor error)

Table 19: Emergency cooling sensor error

Label ID <sup>(1)</sup>	Parameter name	Description and selection options	Min.	Max	Factory Setting	Decimals	Locked by Main switch Yes/No	Read	Password level to change/write	Modbus address	Read only (RO) / Read Write (RW)	Persistent Yes/No	Modbus function
P20	Ther. sensor error	<b>Thermostat sensor error</b> If no thermostat sensor is available because of sensor faults, then emergency cooling takes over to maintain a reasonable level of cooling Select action at emergency cooling mode 0: Stop cooling 1: Fixed OD This means that the Evaporator will run in a ON/OFF cycle defined by a period of 1 hour and the setting of parameter "P22, Fixed OD emer. cool" E.g. "P22, Fixed OD emer. cool" = 40% Evaporator ON: 40% x 60 min=24 min Evaporator OFF: (100%-40%)( x 60 min=36 min 2: Use average values	0	2	2=Use average values	0	Yes	Pass-word level 1,2,3	3	3127	RW	Yes	3, 4 & 16
P22	Fixed OD emer. cool	<b>Fixed valve Opening Degree emergency cooling</b> Fixed valve OD at emergency cooling of the Liquid line valve See "P20,Ther. sensor error" Unit: %	0	100	0	0	Yes	Pass-word level 1,2,3	3	3129	RW	Yes	3, 4 & 16
P21	SH sensor error	<b>Select how to operate emergency cooling</b> 0: Stop cooling 1: Fixed OD 2: Use average values	0	2	2	0	Yes	Pass-word level 1,2,3	3	3128	RW	Yes	3, 4 & 16

## Evaporator and room control, type EKE 400

Label ID <sup>(1)</sup>	Parameter name	Description and selection options	Min.	Max	Factory Setting	Decimals	Locked by Main switch Yes/No	Read	Password level to change/write	Modbus address	Read only (RO) / Read Write (RW)	Persistent Yes/No	Modbus function
P23	Suct. ctrl at sensor error	<b>Evaporation pressure control at sensor error. Emergency cooling operation</b>  0: Stop cooling 1: Fixed value 2: Valve fully open	0	2	2	0	Yes	Password level 1,2,3	3	3130	RW	Yes	3, 4 & 16
P2A / P24	Fix. value emer. Cool.	<b>Fixed OD value at emergency cooling</b>  When P21, SH sensor error = Fixed OD, then a fixed OD for the liquid line valve can be entered Unit: %	0	100	0	0	Yes	Password level 1,2,3	3	3404 / 3131	RW	Yes	3, 4 & 16
P26	Ext ref. T0 config.	<b>External displacement of Pressure setpoint in Wet Return control</b> An offset can be added to the setpoint T17, Evap.Pres. SP To (in degrees)  0: Not used; 1: Displace by current: See scaling in P29, Ref. current T0 high and P30, Ref. current T0 low 2: Displace by voltage: See scaling in P31, Ref. voltage T0 high and P32, Ref. voltage T0 low 3: Displace by modbus: See P33, Ref. offset T0 by modbus 4: Displace by DI: See P34, Ref. offset T0 by DI	0	4	0	0	Yes	Password level 1,2,3	3	3486	RW	Yes	3, 4 & 16
P27	Ref. offset T0 max	<b>Temperature offset range - max value</b>  Scaling of range, max value, proportional to Analog Input (mA or Voltage) Unit: K	0.0	50.0	0.0	1	No	Password level 1,2,3	3	3487	RW	Yes	3, 4 & 16
P28	Ref. offset T0 min	<b>Temperature offset range - min value</b>  Scaling of range, min value, proportional to Analog Input (mA or Voltage) Unit: K	-70.0	0.0	0.0	1	No	Password level 1,2,3	3	3488	RW	Yes	3, 4 & 16
P29	Ref. current T0 high	<b>AI signal range - high mA value</b>  Scaling of mA range, high value Unit: mA	0.0	20.0	20.0	1	No	Password level 1,2,3	3	3489	RW	Yes	3, 4 & 16
P30	Ref. current T0 low	<b>AI signal range - low mA value</b>  Scaling of mA range, low value Unit: mA	0.0	20.0	4.0	1	No	Password level 1,2,3	3	3490	RW	Yes	3, 4 & 16
P31	Ref. voltage T0 high	<b>AI signal range - high voltage value</b>  Scaling of voltage range, high value Unit: V	0.0	10.0	10.0	1	No	Password level 1,2,3	3	3491	RW	Yes	3, 4 & 16
P32	Ref. voltage T0 low	<b>AI signal range - low voltage value</b>  Scaling of voltage range, low value Unit: V	0.0	10.0	0.0	1	No	Password level 1,2,3	3	3492	RW	Yes	3, 4 & 16
P33	Ref. offset T0 by modbus	<b>Offset value send via network</b>  Enter value via MODBUS Unit: K	-70.0	50.0	0.0	1	No	Password level 1,2,3	3	3493	RW	Yes	3, 4 & 16
P34	Ref. offset T0 by DI	<b>Reference Offset by DI</b> If P26, Ext ref. T0 config.=Displace by DI, then if the assigned DI:  OFF: No offset added ON: Value entered here will be added T17, Evap.Pres. SP To (in degrees) Unit: K	-70.0	50.0	0.0	1	No	Password level 1,2,3	3	3494	RW	Yes	3, 4 & 16
SS1	Temperature sensor	<b>Extra temperature sensor</b>  Select 0: No 1: Yes	No	Yes	No	0	No	Password level 1,2,3	3	3509	RW	Yes	3, 4 & 16

## Evaporator and room control, type EKE 400

Label ID <sup>(1)</sup>	Parameter name	Description and selection options	Min.	Max	Factory Setting	Decimals	Locked by Main switch Yes/No	Read	Password level to change/write	Modbus address	Read only (RO) / Read Write (RW)	Persistent Yes/No	Modbus function
SSt	Temperature	<b>Temperature reading</b>	0	100	0	1	No	Pass-word level 1,2,3	0	3510	RO		3, 4 & 16
SP1	Pressure sensor	<b>Extra pressure sensor</b> Select 0: No 1: Yes	No	Yes	No	0	No	Pass-word level 1,2,3	3	3511	RW	Yes	3, 4 & 16
SPP	Pressure	<b>Pressure reading</b>	0	200	0	1	No	Pass-word level 1,2,3	0	3512	RO		3, 4 & 16

<sup>(1)</sup> Visibility depends on other parameter settings. Numbers are displayed in Metric units ( P01, Temperature units=MET).

## System \ Display

Table 20: System \ Display

Label ID <sup>(1)</sup>	Parameter name	Description and selection options	Min.	Max	Factory Setting	Decimals	Locked by Main switch Yes/No	Read	Password level to change/write	Modbus address	Read only (RO) / Read Write (RW)	Persistent Yes/No	Modbus function
G01	Language	0: English; 5: French;3:Italian; 4:German; 16: Dutch; 17: Japan; 13: Portuguese; 6: Spanish; 9:Russian; 14: Chinese; 18: Korean	0	13	0=English	0	No	Pass-word level 1,2,3	2	3106	RW	Yes	3, 4 & 16
G02	Time format	<b>Time format</b> 0:24-hour format 1:12-hour format	0	1	0=24-hour format	0	No	Pass-word level 1,2,3	2	3107	RW	Yes	3, 4 & 16
G03	Screen saver time	<b>Screen saver time</b> If no push bottoms have been activated for the entered period, the backlight in the display will be weaker. Display backlight will revoked upon activation of any of the push bottoms Unit: min	1	60	2	0	No	Pass-word level 1,2,3	2	3189	RW	Yes	3, 4 & 16
G04	User logout time	<b>User logout time</b> If no push bottoms have been activated for the entered period, a logout will be carried out to Password level 0. Level 0 will only allow to see the screens: "Status screen 1", "Active alarms", "Alarm Reset" and "Controller info"A forced logout to Password level 0 can be made from screen: "Status screen 1" - Push the "Escape" button for 3 seconds Unit: min	1	60	2	0	No	Pass-word level 1,2,3	2	3191	RW	Yes	3, 4 & 16
G05	Display contrast	<b>Display contrast</b>	0	100	30	0	No	Pass-word level 1,2,3	2	3190	RW	Yes	3, 4 & 16

<sup>(1)</sup> Visibility depends on other parameter settings. Numbers are displayed in Metric units ( P01, Temperature units=MET)..

## System \ Password

**Table 21: System \ Password**

Label ID <sup>(1)</sup>	Parameter name	Description and selection options	Min.	Max	Factory Setting	Decimals	Locked by Main switch Yes/No	Read	Password level to change/write	Modbus address	Read only (RO) / Read Write (RW)	Persistent Yes/No	Modbus function
G07	Password level 1	<b>Password level 1</b> Enter password for level 1 access. Level 1 will give access to see all parameters and sub menus, but no settings can be changed. See Column "Read" and "Password level to change/write"	1	999	100	0	No	Password level 1,2,3	1	3108	RW	Yes	3, 4 & 16
G08	Password level 2	<b>Password level 2</b> Enter password for level 2 access. Level 2 will give access to see all parameters and sub menus. Some settings can be changed. See Column "Read" and "Password level to change/write"	1	999	200	0	No	Password level 2,3	2	3109	RW	Yes	3, 4 & 16
G09	Password level 3	<b>Password level 3</b> Enter password for level 3 access. Level 3 will give access to see all parameters and sub menus. All settings can be changed. See Column "Read" and "Password level to change/write"	1	999	300	0	No	Password level 3	3	3110	RW	Yes	3, 4 & 16
G15	For Danfoss only	<b>For Danfoss only</b>											

<sup>(1)</sup> Visibility depends on other parameter settings. Numbers are displayed in Metric units ( P01, Temperature units=MET).

## System \ Real time clock

**Table 22: System \ Real time clock**

Label ID <sup>(1)</sup>	Parameter name	Description and selection options	Min.	Max	Factory Setting	Decimals	Locked by Main switch Yes/No	Read	Password level to change/write	Modbus address	Read only (RO) / Read Write (RW)	Persistent Yes/No	Modbus function
G10	Real time clock	<b>Real time clock</b> Enter date (year, month and day) and time (hour and minute)					No	Password level 1,2,3	2	1807 (to read) 1809 (to set)	RW	Yes	3, 4 & 16

<sup>(1)</sup> Visibility depends on other parameter settings. Numbers are displayed in Metric units ( P01, Temperature units=MET).



## System \ Network

Table 23: System \ Network

Label ID <sup>(1)</sup>	Parameter name	Description and selection options	Min.	Max	Factory Setting	Decimals	Locked by Main switch Yes/No	Read	Password level to change/write	Modbus address	Read only (RO) / Read Write (RW)	Persistent Yes/No	Modbus function
G11	Modbus address	<b>Modbus address</b> Set the address of the controller here if it is connected to a system device via data communication.	1	125	1	0	Yes	Pass-word level 1,2,3	3	3111	RW	Yes	3, 4 & 16
G12	Baudrate	<b>Baudrate</b> The system unit usually communicates with 38.400.  0:0 12:1200 24:2400 48:4800 96:9600 144:14400 192:19200 288:28800 384:38400	0	384	384=38400	0	Yes	Pass-word level 1,2,3	3	3112	RW	Yes	3, 4 & 16
G13	Serial mode	<b>Serial mode</b> Serial modbus mode. 8N1, 8E1 (8 bit, Even parity), 8N2.	8N1	8N2	8E1	0	Yes	Pass-word level 1,2,3	3	3113	RW	Yes	3, 4 & 16

<sup>(1)</sup> Visibility depends on other parameter settings. Numbers are displayed in Metric units ( P01, Temperature units=MET).

## System \ Reset to factory

Table 24: System \ Reset to factory

Label ID <sup>(1)</sup>	Parameter name	Description and selection options	Min.	Max	Factory Setting	Decimals	Locked by Main switch Yes/No	Read	Password level to change/write	Modbus address	Read only (RO) / Read Write (RW)	Persistent Yes/No	Modbus function
G14	Reset to factory	<b>Reset to factory</b> No: Not active Yes: All parameters will be returned to factory default settings, and the alarm list will be cleared. The parameter will automatically be set back to 'No' when factory reset has finished (after a few seconds). OBSERVE below mention parameters will be left unchanged: "G01, Language" "G10, Real time clock" "G11, Modbus address" "G12, Baudrate" "G13, Serial mode"	0=No	1=Yes	0=No		Yes	Pass-word level 3	3	3114	RW	Yes	3, 4 & 16

<sup>(1)</sup> Visibility depends on other parameter settings. Numbers are displayed in Metric units ( P01, Temperature units=MET).

## Control status \ read-outs Control Status

**Table 25: Control status / read-outs Control Status**

Label ID <sup>(1)</sup>	Parameter name	Description and selection options	Min.	Max	Factory Setting	Decimals	Locked by Main switch Yes/No	Read	Password level to change/write	Modbus address	Read only (RO) / Read Write (RW)	Persistent Yes/No	Modbus function
See . OBSERVE some readouts are only visible under specific conditions													
S01	Control state	Read out of the actual state EKE will process during cooling and defrost. See sheet "O-Tables" <a href="#">Table 15: Defrost function \ Defrost sequence</a> in this document				0				3270	RO	No	3
S02	Cooling status	Status of EKE 400 in status cooling. OFF: No request for cooling. ON: Request for cooling. Can be used via MODBUS (e.g. PLC)				0				3165	RO	No	3
S03	Ther. temp.	Temperature used for the thermostat function <i>Unit: °C / °F</i>	-200.0	200.0	0.0	2				3166	RO	No	3
S04	Night status	Status of day/night operation On: Night operation				0				3167	RO	No	3
S05	Cut in limit	Thermostat cut in limit adjusted with night offset <i>Unit: °C / °F</i>				2				3168	RO	No	3
S06	Cut out limit	Thermostat cut out limit adjusted with night offset <i>Unit: °C / °F</i>				2				3169	RO	No	3
S07	Alarm air temp.	"Only visible if "B01,Air temp. alarm" differ (≠) from "None" Room temperature used for the alarm function <i>Unit: °C / °F</i>				2				3163	RO	No	3
S08	Product temp.	"Only visible if "B05,Product alarm function" = "Yes" Measured product sensor temperature <i>Unit: °C / °F</i>				2				3170	RO	No	3
S1A	Control State Translated	<b>Control State Translated: Read-out of regulation condition / control state</b>  1: Main switch is OFF; 2: Manual control; 3:Pump down; 4: HG open delay; 5: HG Drip tray; 6: HG soft opening; 7: Defrosting; 8: HG close delay; 9: Drain close delay; 10: Drip off time; 11: WR opening state; 12: Fan start delay; 13: Not used; 14: Forced closing; 15: Forced cooling; 16: Emergency control; 17: Modulating WR. control; 18: MTR control; 19: Cooling; 20: Cooling stopped; 21: Refrig. not selected; 22: Power up state; 23: Critical Alarm; 24: PWM modulation  <b>Not visible from HMI. Can be read via MODBUS</b>			1	0				3270	RO	No	
S2A	Merge Main Switch	<b>Status of Mainswitch parameters</b>  "M01,Main switch" "M02,Ext. Main switch"  Only if state of both "M01,Main switch" AND M02,Ext. Main switch" is ON then "S2A, Merge Main Switch" is 1, else 0.  <b>Not visible from HMI. Can be read via MODBUS</b>	0	1		0				3271	RO	No	
S09	Defrosting time	The duration of the last executed defrost is shown <i>Unit: min</i>				0				3171	RO	No	3
S10	Def. sensor temp.	"Only visible if "D40,Defrost stop method"="Stop on time" Defrost sensor temperature <i>Unit: °C / °F</i>				2				3172	RO	No	3

## Evaporator and room control, type EKE 400

Label ID <sup>(1)</sup>	Parameter name	Description and selection options	Min.	Max	Factory Setting	Decimals	Locked by Main switch Yes/No	Read	Password level to change/write	Modbus address	Read only (RO) / Read Write (RW)	Persistent Yes/No	Modbus function
S11	Defrost state time	Actual active time delay shown in actual state <i>Unit: min</i>				0				3173	RO	No	3
S12	Act. state time	Actual remaining time left of "S11,Defrost state time" <i>Unit: min</i>				0				3174	RO	No	3
S16	Evap. press Pe	Actual evaporating pressure Pe <i>Unit: Bar / psi</i>			0.0	2				3175	RO	No	
S17	Evap. temp. Te	Actual evaporating temperature Te converted from pressure <i>Unit: °C / °F</i>			0.0	2				3179	RO	No	
S18	S2 suction pipe	The gas temperature measured at evaporator outlet. <i>Unit: °C / °F</i>			0.0	2				3180	RO	No	3
S19	S3 air inlet temp	Actual air inlet temperature <i>Unit: °C / °F</i>			0.0	2				3181	RO	No	3
S20	Actual OD % for LL	Actual opening degree of Liquid valve in DX and PWM <i>Unit: %</i>				2				3182	RO	No	
S21	Superheat	Actual superheat (Gas temp. out - Evap.temp Te) <i>Unit: °C / °F</i>			0.0	1				3183	RO	No	3
S22	SH reference	Reference used for the superheat control <i>Unit: °C / °F</i>			10.0	1				3184	RO	No	3
S23	Status Buzzer	Status buzzer								3275	RO	No	3
S24	Hours from Defrost	Time in hours since last defrost <i>Unit: hours</i>				0				3319	RO	No	3
S26	Emergency control period	Emergency control period time in minutes <i>Unit: min</i>				0				3321	RO	No	3
S27	Emergency control duty	Emergency control duty time in minutes <i>Unit: min</i>				0				3322	RO	No	3
S28	Gas Conc.tra.	Gas Concentration [ppm] <i>Unit: ppm</i>	0	50000		0				3330	RO	No	3
S32	Reference SP	Reference setpoint for Modulating WR ctrl								3434	RO	No	3

<sup>(1)</sup> Visibility depends on other parameter settings. Numbers are displayed in Metric units ( P01, Temperature units=MET).

## IO configuration

Table 26: IO configuration

Label ID <sup>(1)</sup>	Parameter name	Description and selection options	Min.	Max	Factory Setting	Decimals	Locked by Main switch Yes/No	Read	Password level to change/write	Modbus address	Read only (RO) / Read Write (RW)	Persistent Yes/No	Modbus function
<b>IO configuration \ Digital outputs</b>													
	DO1...DO8	When a function that needs to use an Digital Output (DO) is defined, it will be possible to assign this function to one of the available DO. Select the function to assign to the actual DO and if the function is to be active when the DO is activated or deactivated.											
<b>IO configuration \ Digital inputs</b>													
	DI1...DI8	When a function that needs to use an Digital Input (DI) is defined, it will be possible to assign this function to one of the available DI. Select the function to assign to the actual DI.											
<b>IO configuration \ Analog outputs - Voltage</b>													

## Evaporator and room control, type EKE 400

Label ID <sup>(1)</sup>	Parameter name	Description and selection options	Min.	Max	Factory Setting	Decimals	Locked by Main switch Yes/No	Read	Password level to change/write	Modbus address	Read only (RO) / Read Write (RW)	Persistent Yes/No	Modbus function
	AO1, AO2, AO3, AO4	When a function that needs to use an Analog Output (DO) is defined, it will be possible to assign this function to one of the available AO. Select the function to assign to the actual AO and define voltage range 0 – 1 V, 0 – 5 or 0 – 10 V											
<b>IO configuration \ Analog inputs</b>													
	AI1...AI8	When a temperaturefunction that needs to use an Analog Input (AI) is defined, it will be possible to assign this function to one of the available AI. Select the function to assign to the actual AI. It is possible to add an offset value to compensate for long cables under "Cal." parameter											

<sup>(1)</sup> Visibility depends on other parameter settings. Numbers are displayed in Metric units ( P01, Temperature units=MET).

## IO status

Table 27: IO status

Label ID <sup>(1)</sup>	Parameter name	Description and selection options	Min.	Max	Factory Setting	Decimals	Locked by Main switch Yes/No	Read	Password level to change/write	Modbus address	Read only (RO) / Read Write (RW)	Persistent Yes/No	Modbus function
<b>IO status \ Digital outputs</b>													
	DO1...DO8	Status (OFF/ON) if all DO. If a function is assigned the function name will be displayed. DO not used, will display "-----"											
	DO1	Actual assigned parameter to DO								1003.8	RO		3
	DO2									1003.9	RO		3
	DO3									1003.1	RO		3
	DO4									1003.11	RO		3
	DO5									1003.12	RO		3
	DO6									1003.13	RO		3
	DO7									1003.14	RO		3
	DO8									1003.15	RO		3
<b>IO status \ Digital inputs</b>													
	DI1...DI8	Status (OFF/ON) if all DI. If a function is assigned the function name will be displayed. DI not used, will display "-----"											
	DI1	Actual assigned parameter to DI								1001.8	RO		3
	DI2									1001.9	RO		3
	DI3									1001.1	RO		3
	DI4									1001.11	RO		3
	DI5									1001.12	RO		3
	DI6									1001.13	RO		3
	DI7									1001.14	RO		3
	DI8									1001.15	RO		3
<b>IO status \ Analog outputs</b>													
	AO1, AO2, AO3, AO4	Status of analogue outputs. Value in 0-100 % max. Output signal											
	AO1	Actual assigned parameter to AO								1037	RO		3
	AO2									1038	RO		3
	AO3									1039	RO		3
	AO4									1040	RO		3
<b>IO status \ Analog inputs</b>													
	AI1...AI8	Status of analogue temperature inputs. Temperature values (includes possible offset calibration values).											

## Evaporator and room control, type EKE 400

Label ID <sup>(1)</sup>	Parameter name	Description and selection options	Min.	Max	Factory Setting	Decimals	Locked by Main switch Yes/No	Read	Password level to change/write	Modbus address	Read only (RO) / Read Write (RW)	Persistent Yes/No	Modbus function
	AI1	Actual assigned parameter to AI								1005	RO		3
	AI2									1006	RO		3
	AI3									1007	RO		3
	AI4									1008	RO		3
	AI5									1009	RO		3
	AI6									1010	RO		3
	AI7									1011	RO		3
	AI8									1012	RO		3
<b>IO status \ IO summary</b>													
	IO summary	<p><b>Inputs and outputs overview. Display of maximum available and how many is actual being used.</b></p> <p>OBSERVE: If too many have been defined, an exclamation mark (!) will appear.</p>											

<sup>(1)</sup> Visibility depends on other parameter settings. Numbers are displayed in Metric units ( P01, Temperature units=MET).

## IO manual control

Table 28: IO manual control

Label ID <sup>(1)</sup>	Parameter name	Description and selection options	Min.	Max	Factory Setting	Decimals	Locked by Main switch Yes/No	Read	Password level to change/write	Modbus address	Read only (RO) / Read Write (RW)	Persistent Yes/No	Modbus function
<b>IO manual control \ Digital outputs</b>													
	DO1...DO8	<p><b>Manual override control of a DO</b></p> <p>AUTO: DO is controlled automatically by EKE 400 ON: DO is forced ON - an alarm is will be active "Output in manual mode" OFF: DO is forced OFF</p> <p>OBSERVE: Remember to switch back to "AUTO" when an override have been made (OFF/ON)</p>											
<b>IO manual control \ Analog outputs</b>													
	AO1, AO2, AO3, AO4	<p><b>Manual override control of a AO</b></p> <p>AUTO: AO is controlled automatically by EKE 400 MAN: If MAN is selected, A manual output value [0-100 %] of max. AO value can be entered in parameter "Man". - an alarm is will be active "Output in manual mode"</p> <p>OBSERVE: Remember to switch back to "AUTO" when an override have been selected ("MAN")</p>											

<sup>(1)</sup> Visibility depends on other parameter settings. Numbers are displayed in Metric units ( P01, Temperature units=MET).

## Alarm setting

**Table 29: Alarm setting**

Label ID <sup>(1)</sup>	Parameter name	Description and selection options	Min.	Max	Factory Setting	Decimals	Locked by Main switch Yes/No	Read	Password level to change/write	Modbus address	Read only (RO) / Read Write (RW)	Persistent Yes/No	Modbus function	
<b>Alarm settings\ Alarm priorities</b>														
		<p><b>The controller will issue an alarm notification if a specific incident occurs. Each incident is set to indicate the importance of each alarm, but it is possible to modify the importance of each. Choose between the following priority levels:</b></p> <p>0: Critical: Important alarms that require a high level of attention.                      1: Severe: Alarms of intermediate importance                      2: Normal: No important alarms                      3: Disable: Alarms set to this priority level will be cancelled.</p>												
A48	Pressure sens.error	<b>Pressure sensor is defect</b>	0	3	2		No		Password level 1,2,3	2	3506	RW	Yes	3, 4 & 16
A49	Ext.Ref.Conf.	External Reference input defect	0	3	2						3353	RW	Yes	
A50	Ther. air sensor error	Thermostat sensor is defect	0	3	2		No		Password level 1,2,3	2	3132	RW	Yes	3, 4 & 16
A51	Ther. air 2 sensor error	Thermostat sensor 2 is defect	0	3	2		No		Password level 1,2,3	2	3133	RW	Yes	3, 4 & 16
A52	Ther. air 3 sensor error	Thermostat sensor 3 is defect	0	3	2		No		Password level 1,2,3	2	3134	RW	Yes	3, 4 & 16
A53	Air alarm sensor error	Air alarm sensor is defect	0	3	2		No		Password level 1,2,3	2	3135	RW	Yes	3, 4 & 16
A54	Defrost sensor error	Defrost sensor is defect	0	3	2		No		Password level 1,2,3	2	3136	RW	Yes	3, 4 & 16
A55	Product sensor error	Product sensor is defect	0	3	2		No		Password level 1,2,3	2	3137	RW	Yes	3, 4 & 16
A59	Standby mode	Alarm when control is stopped by internal or external Main Switch (DI input )	0	3	2		No		Password level 1,2,3	2	3141	RW	Yes	3, 4 & 16
A60	Refrigerant not set	<b>Alarm if no refrigerant has been selected</b>	0	3	3		No		Password level 1,2,3	2	3142	RW	Yes	3, 4 & 16
A61	High temp. alarm	The room temperature is too high	0	3	0		No		Password level 1,2,3	2	3143	RW	Yes	3, 4 & 16
A62	Low temp. alarm	The room temperature is too low	0	3	0		No		Password level 1,2,3	2	3144	RW	Yes	3, 4 & 16
A63	High product temp. alarm	The product temperature is too high	0	3	1		No		Password level 1,2,3	2	3145	RW	Yes	3, 4 & 16

## Evaporator and room control, type EKE 400

Label ID <sup>(1)</sup>	Parameter name	Description and selection options	Min.	Max	Factory Setting	Decimals	Locked by Main switch Yes/No	Read	Password level to change/write	Modbus address	Read only (RO) / Read Write (RW)	Persistent Yes/No	Modbus function
A64	Low product temp. alarm	The product temperature is too low	0	3	1		No	Password level 1,2,3	2	3146	RW	Yes	3, 4 & 16
A65	Max. defrost time	The max allowed defrost time is exceeded	0	3	2		No	Password level 1,2,3	2	3147	RW	Yes	3, 4 & 16
A66	Output in MAN mode	An output is set in manual mode	0	3	2		No	Password level 1,2,3	2	3148	RW	Yes	3, 4 & 16
A67	IO config. error	Not all inputs and output functions have been assigned to hardware Inputs or outputs	0	3	-		No			3149	RW	Yes	3, 4 & 16
A68	Critical Alarm	Critical Alarm by DI	0	3	0		No	Password level 1,2,3	2	3332	RW	Yes	3, 4 & 16
A69	Gas sensor err.	<b>Gas sensor is defect</b> 0: Critical 1: Severe 2: Normal 3: Disable	0	3	2		No	Password level 1,2,3	2	3352	RW	Yes	3, 4 & 16
A76	S2 suction alarm	<b>Sensor S2 defect</b>	0	3	2		No	Password level 1,2,3	2	3359	RW	Yes	3, 4 & 16
A77	S3 media inlet Alarm	<b>Sensor S3 defect</b>	0	3	2		No	Password level 1,2,3	2	3360	RW	Yes	3, 4 & 16
A78	High Pressure evap. Alarm	<b>High Pressure MOP in DX</b>	0	3	2		No	Password level 1,2,3	2	3361	RW	Yes	3, 4 & 16
A79	Ext.Ref.SH Conf.al.	<b>External reference input for SH defect</b>	0	3	2		No	Password level 1,2,3	2	3408	RW	Yes	3, 4 & 16
A83	LL valve DI alarm	<b>Liquid line valve alarm by DI</b> If A80,LL valve DI alarm=Yes Alarm Motorized Valve in Liquid Line	0	3	2		No	Password level 1,2,3	2	3448	RW	Yes	3, 4 & 16
A84	WR/SL valve DI alarm	<b>Wet Return/Suction line valve alarm by DI</b> If A81,WR valve DI alarm=Yes Alarm Motorized Valve in Wet Return Line	0	3	2		No	Password level 1,2,3	2	3449	RW	Yes	3, 4 & 16
A85	HG valve DI alarm	<b>Hot Gas line valve alarm by DI</b> If A82,HG valve DI alarm=Yes Alarm Motorized Valve in Hot Gas Line	0	3	2		No	Password level 1,2,3	2	3450	RW	Yes	3, 4 & 16
A86	LL valve AI alarm	<b>Liquid line valve Analog Input Alarm</b> Analog input Alarm from Motorized Valve - out of scale	0	3	2		No	Password level 1,2,3	2	3495	RW	Yes	3, 4 & 16
A87	WR/SL valve AI alarm	<b>Wet Return/Suction line valve Analog Input Alarm</b> Analog input Alarm from Motorized Valve - out of scale	0	3	2		No	Password level 1,2,3	2	3496	RW	Yes	3, 4 & 16

## Evaporator and room control, type EKE 400

Label ID <sup>(1)</sup>	Parameter name	Description and selection options	Min.	Max	Factory Setting	Decimals	Locked by Main switch Yes/No	Read	Password level to change/write	Modbus address	Read only (RO) / Read Write (RW)	Persistent Yes/No	Modbus function
A88	HG valve Al alarm	<b>Hot Gas line valve Analog Input Alarm</b> Analog input Alarm from Motorized Valve - out of scale	0	3	2		No	Pass-word level 1,2,3	2	3497	RW	Yes	3, 4 & 16
A89	Humidity sens.error	<b>Humidity sensor Analog input Alarm</b> Analog input Alarm from Humidity sensor - out of scale	0	3	2		No	Pass-word level 1,2,3	2	3498	RW	Yes	3, 4 & 16
A90	Ext.Ref.T0 Conf.al.	<b>External displacement of Pressure setpoint in Wet Return control</b> Analog input Alarm from External displacement of Pressure setpoint - out of scale	0	3	2		No	Pass-word level 1,2,3	2	3499	RW	Yes	3, 4 & 16

<sup>(1)</sup> Visibility depends on other parameter settings. Numbers are displayed in Metric units ( P01, Temperature units=MET).

## Alarm setting \ Critical Alarm

Table 30: Valve digital alarms

Label ID <sup>(1)</sup>	Parameter name	Description and selection options	Min.	Max	Factory Setting	Decimals	Locked by Main switch Yes/No	Read	Password level to change/write	Modbus address	Read only (RO) / Read Write (RW)	Persistent Yes/No	Modbus function
S70	Manual alarm reset	Manual alarm reset of Critical Alarm, select YES to reset	No	Yes	No	0	No	Pass-word level 1,2,3	3	3333	RW	Yes	3, 4 & 16
A70	Crit.alarm status	<b>Critical Alarm status</b> 0 = not active 1 = active	0	1	Yes	0	Yes			3329	RW	Yes	3, 4 & 16
A71	Crit.ext.alarm DI?	<b>Enable DI for Critical Alarm</b>  <b>NOTE:</b> EKE 400 controller must never be primary safety.	No	Yes	No	0	Yes	Pass-word level 1,2,3	3	3327	RW	Yes	3, 4 & 16
A72	WR/SL alarm mode	<b>Wet Return/Suction line status in Critical Alarm status</b>	OFF	ON	OFF	0	No	Pass-word level 1,2,3	3	3328	RW	Yes	3, 4 & 16
A73	Fan alarm mode	<b>Fan status in Critical Alarm status</b>	OFF	ON	OFF	0	No	Pass-word level 1,2,3	3	3331	RW	Yes	3, 4 & 16

<sup>(1)</sup> Visibility depends on other parameter settings. Numbers are displayed in Metric units ( P01, Temperature units=MET).



## Valve digital alarms

Table 31: Valve digital alarms

Label ID <sup>(1)</sup>	Parameter name	Description and selection options	Min.	Max	Factory Setting	Decimals	Locked by Main switch Yes/No	Read	Pass-word level to change/write	Modbus address	Read only (RO) / Read Write (RW)	Persistent Yes/No	Modbus function
A80	LL valve DI alarm	<b>Liquid Line valve digital alarm from ICAD</b> Select if an DI Alarm from Liquid Line valve is present or not  No: No DI from Liquid Line valve Yes: DI from Liquid Line valve present. An DI must be assigned under IO configuration \ Digital inputs	No	Yes	No		Yes	Pass-word level 1,2,3	3	3443	RW	Yes	3, 4 & 16
A81	WR/SL valve DI alarm	<b>Wet Return/Suction line valve digital alarm from ICAD</b> Select if an DI Alarm from Liquid Line valve is present or not  No: No DI from WR/SL valve Yes: DI from WR/SL valve present. An DI must be assigned under IO configuration \ Digital inputs	No	Yes	No		Yes	Pass-word level 1,2,3	3	3444	RW	Yes	3, 4 & 16
A82	HG valve DI alarm	<b>Hot Gas Line valve digital alarm from ICAD</b> Select if an DI Alarm from Liquid Line valve is present or not  No: No DI from Hot Gas Line valve Yes: DI from Hot Gas Line valve present. An DI must be assigned under IO configuration \ Digital inputs	No	Yes	No		Yes	Pass-word level 1,2,3	3	3445	RW	Yes	3, 4 & 16

<sup>(1)</sup> Visibility depends on other parameter settings. Numbers are displayed in Metric units ( P01, Temperature units=MET).

## Alarm messages

Label ID	Parameter name	Description and selection options	Min.	Max	Factory setting	Decimals	Locked by Main switch Yes/No	Pass-word level to change/write	Modbus	Read only (RO) / Read Write (RW)	Persistent Yes/No	Modbus function
E01	Sensor Fault	External reference input defect							1901.09	RO	No	3
A50	Ther. air sensor error	Thermostat sensor is defect							1901.11	RO	No	3
A51	Ther. air 2 sensor error	Thermostat sensor 2 is defect							1901.12	RO	No	3
A52	Ther. air 3 sensor error	Thermostat sensor 3 is defect							1901.13	RO	No	3
A53	Air alarm sensor error	Air alarm sensor is defect							1901.14	RO	No	3
A54	Defrost sensor error	Defrost sensor is defect							1901.15	RO	No	3
A55	Product sensor error	Product sensor is defect							1901.00	RO	No	3
A56	Evap. inlet sensor error	Evaporator inlet sensor is defect							1901.01	RO	No	3
A57	Evap. outlet sensor error	Evaporator outlet sensor is defect							1901.02	RO	No	3
A58	Evap. air outlet sensor error	Evaporator air outlet sensor is defect							1901.03	RO	No	3
A59	Standby mode	Alarm when control is stopped by internal or external Main Switch (DI input)							1901.04	RO	No	3
A60	Refrigerant not set	Alarm if no refrigerant has been selected							1901.05	RO	No	3
A61	High temp. alarm	The room temperature is too high							1901.06	RO	No	3

## Evaporator and room control, type EKE 400

Label ID	Parameter name	Description and selection options	Min.	Max	Factory setting	Decimals	Locked by Main switch Yes/No	Password level to change/write	Modbus	Read only (RO) / Read Write (RW)	Persistent Yes/No	Modbus function
A62	Low temp. alarm	The room temperature is too low							1901.07	RO	No	3
A63	High product temp. alarm	The product temperature is too high							1902.08	RO	No	3
A64	Low product temp. alarm	The product temperature is too low							1902.09	RO	No	3
A65	Max. defrost time	The max allowed defrost time is exceeded							1902.10	RO	No	3
A66	Output in MAN mode	An output is set in manual mode							1902.11	RO	No	3
A67	IO config. error	Not all inputs and output functions have been assigned to hardware Inputs or outputs							1902.12	RO	No	3
A68	Critical DI Alarm	Critical Alarm by digital input, need a manual reset to remove it							1902.13	RO	No	3
A69	Gas sensor err.	Gas sensor is defect							1902.14	RO	No	3
A76	S2 sensor error	S2 sensor error is defect							1902.15	RO	No	3
A77	S3 sensor error	S3 sensor error is defect							1902.00	RO	No	3
A78	High Pressure evap. Alarm	High Pressure evap. Alarm							1902.01	RO	No	3
A79	Sensor Fault SH	External reference input for SH defect							1902.02	RO	No	3
A83	LL valve DI alarm	Liquid line valve alarm by DI							1902.03	RO	No	3
A84	WR/SL valve DI alarm	Wet return/suction line valve alarm by DI							1902.04	RO	No	3
A85	HG valve DI alarm	Hot Gas line valve alarm by DI							1902.05	RO	No	3
A86	LL valve AI alarm	Input for lcad in error (out of scale)							1902.06	RO	No	3
A87	WR/SL valve AI alarm	Input for lcad in error (out of scale)							1902.07	RO	No	3
A88	HG valve AI alarm	Input for lcad in error (out of scale)							1903.08	RO	No	3
A89	Humidity sens.error	Sensor for Humidity in error							1903.09	RO	No	3
A90	Sensor Fault T0	External reference input for T0 defect							1903.10	RO	No	3
A91	Fan DI alarm	Fan DI Alarm							1903.11	RO	No	3

## Sequence diagrams

Figure 21: Defrost sequence

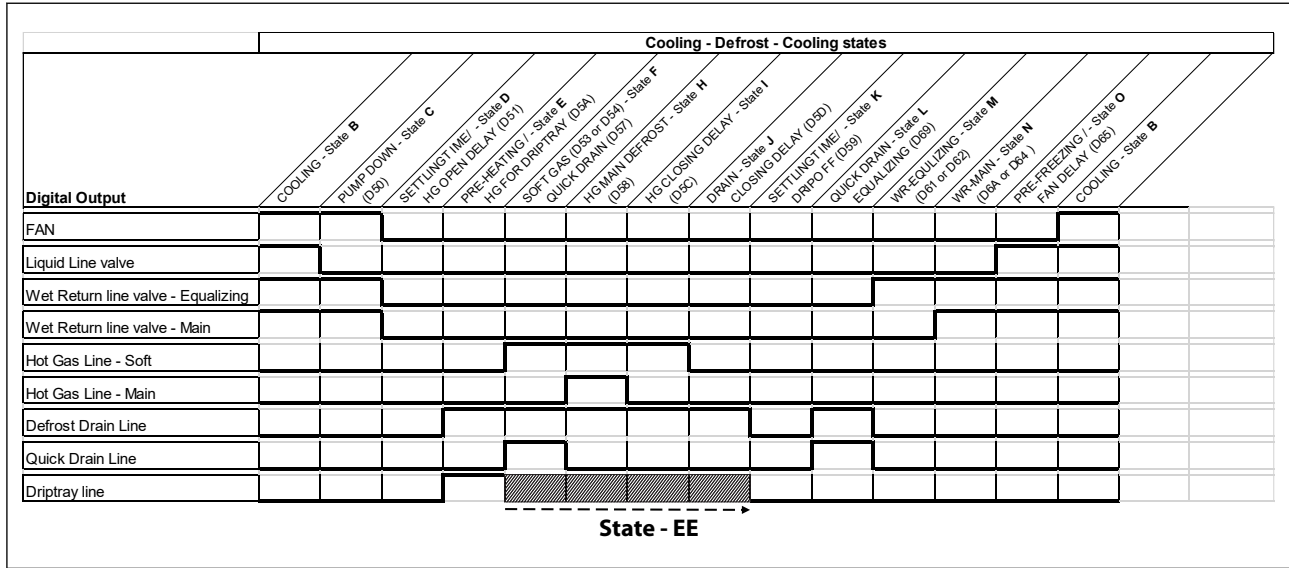

**NOTE:**

**State - EE**

DELAY OFF of HG FOR DRIPTRAY (D5B).  
 DELAY OFF timer starts counting when PRE-HEATING ends.  
 Max DELAY OFF time is to when DRAIN VALVE goes OFF.  
 Operates independent of QUICK DRAIN, SOFT GAS and HOT GAS.  
 Adjustable from 1 sec.

See [Table 32: Parameter and State](#), Parameter and State, for relation between parameters and State

Table 32: Parameter and State

Label ID	Parameter name	Description and selection options	State
D50	Pump down delay	<b>Pump down delay</b>  Draining the evaporator before defrosting. Always active The pump down state is used to empty the evaporator for liquid See <a href="#">Figure 21: Defrost sequence</a>	C
D51	HG open delay	<b>Hot Gas open delay</b>  Time delay in minutes before opening the hot gas valve (delay for valve in the wet return line to close) See <a href="#">Figure 21: Defrost sequence</a>	D
D5A	Drip tray pre-heat	<b>Drip tray pre-heat</b>  Pre-heating time for hot gas to drip tray See <a href="#">Figure 21: Defrost sequence</a>	E
D5B	Drip tray delay OFF	<b>Drip tray delay</b>  OFF Continue drip tray heating some defined time See <a href="#">Figure 21: Defrost sequence</a>	EE
D53	HG soft time	<b>Hot gas soft time</b>  Time between step 1 and step 2 for opening the hot gas valve (2 DO used) See <a href="#">Figure 21: Defrost sequence</a>	F
D54	HG time step 1	<b>Hot Gas time step 1 ICM</b>  Motorvalve: Step 1 time controlled opening to "D55, HG OD step 1" See <a href="#">Figure 21: Defrost sequence</a>	F

## Evaporator and room control, type EKE 400

Label ID	Parameter name	Description and selection options	State
D55	HG OD step 1	<b>Hot Gas valve Opening Degree step 1</b>  ICM Motorvalve: Valve opening from 0% to "D55, HG OD step 1" inside "D54,HG time step 1" time See <a href="#">Figure 21: Defrost sequence</a>	
D56	HG time step 2	<b>Hot Gas time step 2</b>  ICM Motorvalve: Controlled opening in step 2 See <a href="#">Figure 21: Defrost sequence</a>	
D57	Quick drain time	<b>Quick drain time</b>  Require that Quick Drain is selected. (D4B,Quick Drain?=Yes) Enter how long time the Quick Drain valve stays open. Quick Drain valve will start opening together with Hot gas valve See <a href="#">Figure 21: Defrost sequence</a>	F
D58	Max defrost time	<b>Max defrost time</b>  Max. allowed defrost duration in minutes See <a href="#">Figure 21: Defrost sequence</a>	H
D5C	HG close delay	<b>Hot Gas close delay</b>  Require a soft opening valve in the Hot Gas Line (D2A,Hot gas line valve=Soft (ICS+EVRST) or Soft (ICSH) or Slow (ICM)) Delay before closing the selected valves in the Hot gas line See <a href="#">Figure 21: Defrost sequence</a>	I
D5D	Drain close delay	<b>Drain close delay</b>  Require that Drain Valve is selected (D4A, Drain solenoid?=Yes) Delay before the Drain valve is closed See <a href="#">Figure 21: Defrost sequence</a>	J
D59	Drip off time	<b>Drip off time</b>  Allow water on the evaporator to drip off See <a href="#">Figure 21: Defrost sequence</a>	K
D61	WR/SL soft time	<b>Wet Return/Suction Line valve soft time</b>  Time between step 1 and step 2 for opening the wet return valve ("Soft (ICS+EVRST)" or "Soft (ICSH) See <a href="#">Figure 21: Defrost sequence</a>	M
D6A	WR/SL main time	<b>Wet Return/Suction Line valve main time</b>  After defrost and wet return valve has opened (main), enter delay before valve in liquid line to open See <a href="#">Figure 21: Defrost sequence</a>	N
D62	WR/SL time step 1	<b>Wet Return/Suction Line valve time step 1</b>  ICM Motorvalve: Step 1 controlled opening to D63, WR/SL OD step 1 See <a href="#">Figure 21: Defrost sequence</a>	M
D63	WR/SL OD step 1	<b>Wet Return/Suction Line valve Opening Degree step 1</b>  ICM Motorvalve: Valve opening from 0% to "D63,WR/SL OD step 1" inside "D62,WR/SL time step 1" time See <a href="#">Figure 21: Defrost sequence</a>	

## Evaporator and room control, type EKE 400

Label ID	Parameter name	Description and selection options	State
D64	WR/SL time step 2	<b>Wet Return/Suction Line valve time step 2</b>  ICM motorvalve opening step 2 time. See <a href="#">Figure 21: Defrost sequence</a>	N
D69	WR/SL Pr. Equalising	<b>Wet Return/Suction Line Pressure Equalising time</b>  Equalizing pressure in evaporator by soft opening wet return line valve. Carefully emptying the evaporator for hot gas via a little drain valve (by-pass valve) in the wet return line or soft opening of wet return valve See <a href="#">Figure 21: Defrost sequence</a>	L
D65	Fan start delay	<b>Fan start delay Delay</b>  Before start of fans. Liquid Line valve is ON, in this state See <a href="#">Figure 21: Defrost sequence</a>	O

Figure 22: Electrical water and brine defrost

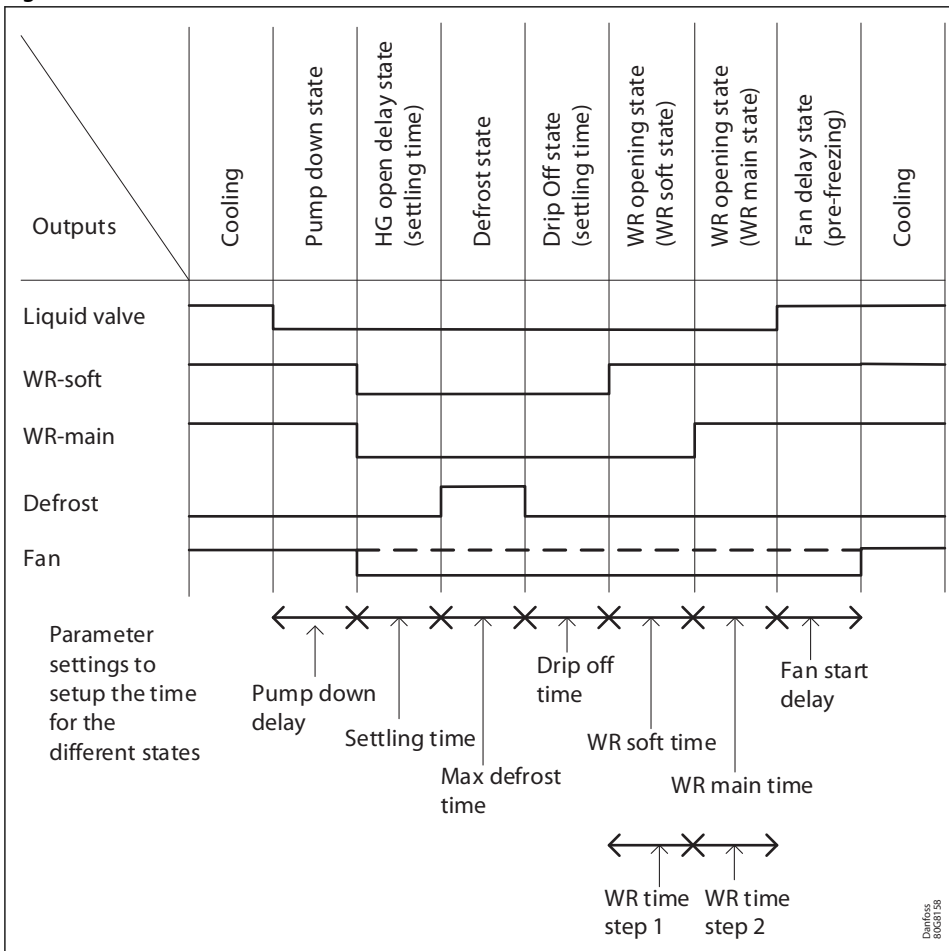
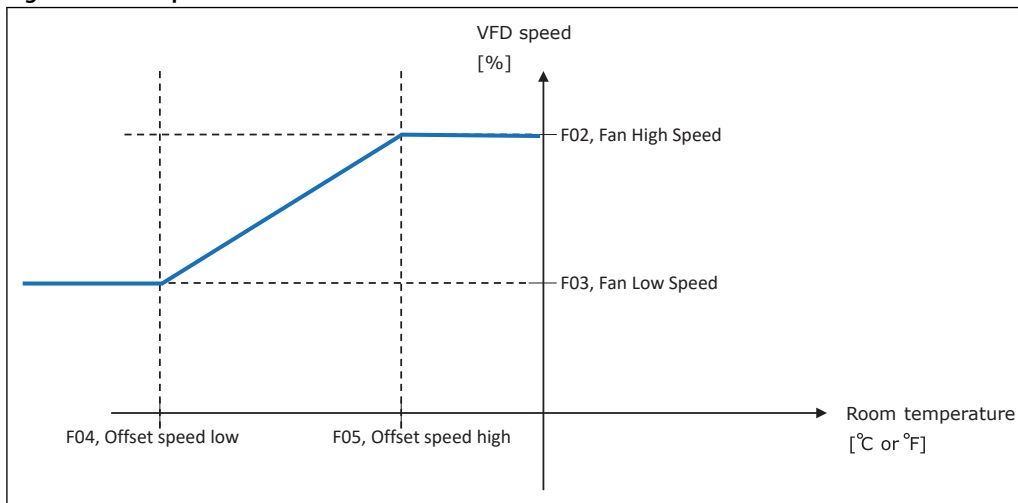

Figure 23: VFD speed



**Example**

- T04, Ther. Setpoint -30 °C
- F02, Fan speed high 100%
- F03, Fan speed low 60%
- F04, Offset speed low 1 [K° or R°]
- F05, Offset speed high 5 [K° or R°]

A temperature between -29 °C to -25 °C would produce a proportional value between 60% to 100 % as speed to the VFD of the fan. Via AO.

If actual temperature is higher than the high temperature setpoint, then speed is 100%.  
If actual temperature is lower than the low temperature setpoint, then speed is 60%.

Figure 24: Reheat function

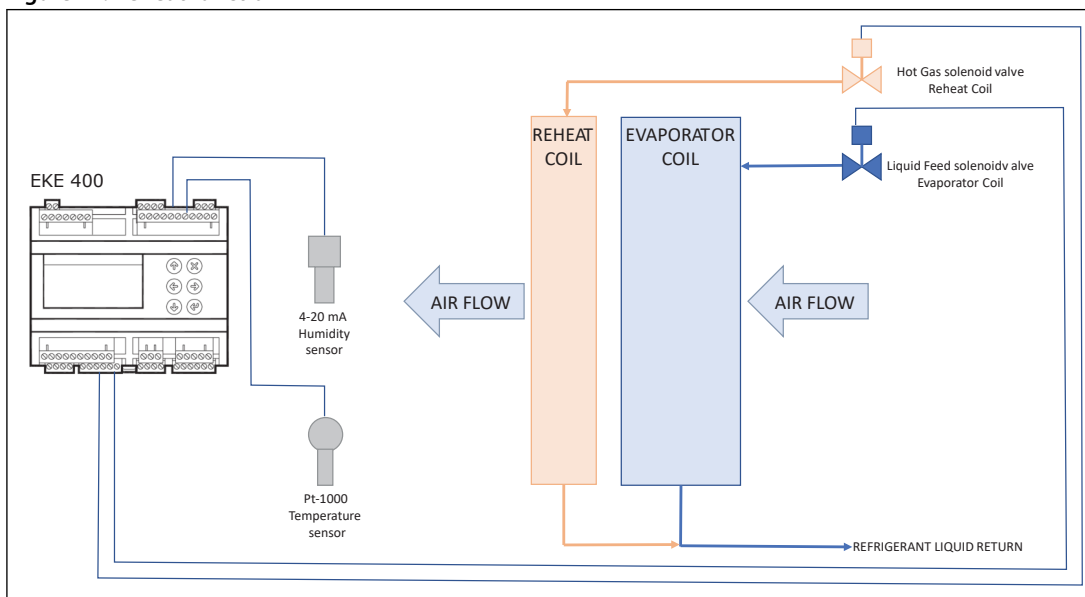

**Reheat function**

**Parameters:**

RH0, Reheat enable?

RH1, Setpoint RH%

- The evaporator will continue to dehumidify the air and the re-heat coil will heat the air to keep the room from getting too cold while trying to reduce humidity
- The evaporator coil will operate in thermostat cut-in/cut-out mode
- The re-heat coil is always off when evaporator coil is off, that is, if cooling is off due to cut-out, any alarm, forced closing, etc., the re-heat coil will be off
- When cooling is on, if the room humidity is above the humidity set-point and the room temperature is below the temperature set-point, the re-heat coil will be on
- If the room humidity falls below the humidity set-point, the re-heat coil will be off
- If the room temperature rises above the temperature set-point, whatever the room humidity is, the re-heat coil will be off

## Evaporator and room control, type EKE 400

- To avoid frequently switch on/off the re-heat coil, hysteresis is necessary
- +1 degree for temperature setpoint
- -5%RH for humidity setpoint

**i NOTE:**

Not possible in:

- DX – MTR mode
- Flooded – PWM mode
- Flooded – WR ctrl. mode

**Table 33: Control status read-outs**

Control state number	Message text	Comments
1	Main switch is OFF	Regulation is Off – controller in standby
2	Manual control	One or more of the outputs are overruled by manual control
3	Pump down	Defrost sequence: Pump down state
4	HG open delay	Defrost sequence: Hot gas delay
5	HG Drip tray	Defrost sequence: Hot gas to drip tray
6	HG soft opening	Defrost sequence: Soft open valve
7	Defrosting	Defrost sequence: Defrosting
8	HG close delay	Defrost sequence: Hot gas close delay
9	Drain close delay	Defrost sequence: Drain close delay
10	Drip off time	Defrost sequence: Drip off time
11	WR opening state	Defrost sequence: Equalizing pressure time
12	Fan start delay	Defrost sequence: Fan start delay
13	Not used	
14	Forced closing	Forced stop of cooling (close liquid line valve)
15	Forced cooling	Forced cooling (typically to secure enough hot gas)
16	Emergency control	One or more sensor error
17	Modulating WR. control	Modulating valve in Wet Return line
18	MTR control	Modulation Thermostat control
19	Cooling	Cooling/refrigeration is active (thermostat cut-in)
20	Cooling stopped	No cooling/refrigeration
21	Refrig. not selected	No refrigerant selected
22	Power up state	Start up after a power cycle
23	Critical Alarm	Critical Alarm detected
24	PWM modulation	Modulating Thermostat (MTR) in Liquid Line (Pulse Width Modulating valve on DO5 or DO6)

**Table 34: Quick Selection of applications**

Label ID	Description	Valve configuration					Analog		
		Liquid Line	Hotgas Line	Wet Return Line	Drain Line	Solenoid up-stream Expansion Valve	Pt1000 AI	Pressure AI	AO
0	User defined								
1	Flooded, Thermostat ON/FF with Hotgas Defrost by pressure or Liquid drain	Solenoid (1 DO)	Solenoid (1 DO)	ICLX (1 DO)	Solenoid (1 DO)		1		
2	DX with Hotgas Defrost by pressure or Liquid drain	ICM (1 AO)	Solenoid (1 DO)	ICLX (1 DO)	Solenoid (1 DO)		1	1	1
3	Flooded, Wet Return line control (pressure) Defrost by pressure or Liquid drain	Solenoid (1 DO)	Solenoid (1 DO)	ICM (1 AO)	Solenoid (1 DO)		1	1	
4	DX and Wet Return line control (pressure) – Contact Danfoss								
5	PWM Modulating Thermostat (MTR) in Liquid Line. Flooded systems	AKVA	Solenoid (1 DO)	ICLX (1 DO)	Solenoid (1 DO)		1		
6	Retrofit/upgrade from EKC 315A to EKE 400 <sup>(1)</sup>	AKVA				Solenoid (1 DO)	1	1	
7	Retrofit/upgrade from EKC 361 to EKE 400 <sup>(1)</sup>	Solenoid (1 DO)		ICM (1 AO)			1		1

<sup>(1)</sup> See [Appendix C](#)

## Input \ Output navigation

From any status screen press ENTER for 2 sec. to access main menu.

Enter the correct password

Figure 25: Input / Output navigation

Move to IO configuration

```

Main Menu
Defrost function
Fan control
Miscellaneous
System
IO configuration
IO status
    
```

Select relevant menu

```

IO configuration
Digital outputs
Digital inputs
Analog outputs
Analog inputs
    
```

Digital outputs

```

i: Hrsol ICH1
Hrsol ICH1
Hrsol ICH2
Drsol
Hrsol ICLX
Fan output
        
```

Digital inputs

```

i: DefrostStart
        
```

Analog outputs

```

i:
        
```

Analog inputs

```

i: Ther. air
        
```

In this image you can see how many outputs and inputs your settings have provided.

```

Main Menu
Defrost function
Fan control
Miscellaneous
System
IO configuration
IO status
    
```

```

IO status
Digital outputs
Digital inputs
Analog outputs
Analog inputs
IO summary
    
```

	Max.	Used
DO:	8	6
DI:	8	1
AO:	4	0
AI:	8	1

Danfoss  
EKE400



## Connections

### Connection diagram

Figure 26: Lower level

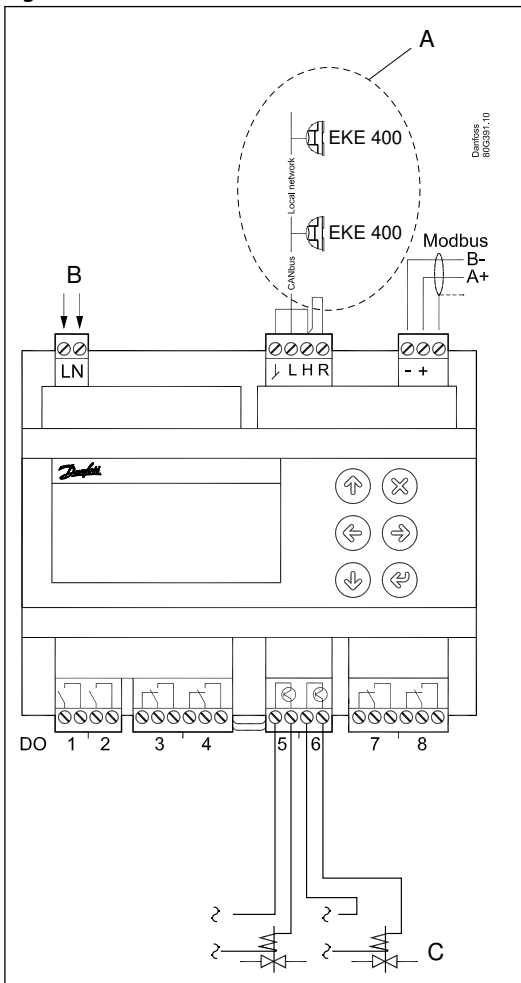

- A** **Network between more EKE 400:** H-R connection has to be made on the first and the last local EKE 400. Connection as close as possible to the connector
- B** Supply voltage
- C** DO5, DO6: Dedicated for PWM Valves (AKV/AKVA)  
**Observe AC only**

Figure 27: Upper level

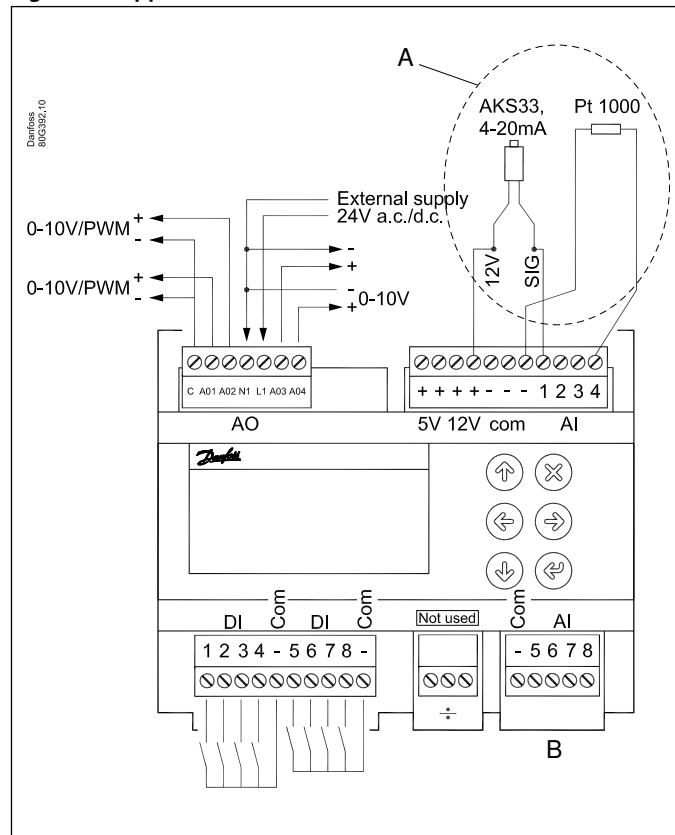

- A** Examples: 1 AKS 33 pressure transmitter 1 Pt 1000 temp. sensor
- B** **⚠ WARNING:**  
The supply voltage of AI may not share the signal with other controllers.

**Electric noise:** Signal cables for sensors, DI inputs, data communication and display must be kept separate from high voltage (230 V) electric cables:

- Use separate cable trays
- Keep a distance between high voltage and signal cables of at least 10 cm Cables for DI input

Cables longer than 10 m (33 ft) is not recommended. At cables longer than 10 meter (33 ft), it is recommended to use auxiliary relays, placed within 10 m (33 ft) cable distance. Typical auxiliary relays then are placed in the same panel, as EKE 400.

**Table 35: Valve configuration**

Valve config. no.	Evaporator Line	Valve selection in Wizard	Parameter number	DO1	DO2	DO3	DO4	DO5	DO6
1	Liquid feed line	Solenoid (ICFE)	R2A	X					
	Hotgas defrost line	Solenoid 2-step (ICSH)	D2A		X	X			
	Defrost drain line	Solenoid (upstream ICFD)	D1B and D4A				X		
	Valve in wet return/suction line	Solenoid 2-step (ICLX)	D3A					X	
	Fan	-	F01						X
2	Liquid feed line	Solenoid (ICFE)	R2A	X					
	Hotgas defrost line	Solenoid (ICS)	D2A		X				
	Defrost drain line	Solenoid (upstream ICFD)	D1B and D4A			X			
	Valve in wet return/suction line	Solenoid 2-step (ICLX)	D3A				X		
	Fan	-	F01					X	
3	Liquid feed line	Solenoid (ICFE)	R2A	X					
	Hotgas defrost line	Solenoid 2-step (ICSH)	D2A		X	X			
	Defrost drain line	Solenoid for quick drain - pressurecontrol)	D1B and D4A				X		
	Valve in wet return/suction line	Solenoid 2-step (ICLX)	D3A					X	
	Fan	-	F01						X
4	Liquid feed line	Solenoid (ICFE)	R2A	X					
	Hotgas defrost line	Solenoid (ICS)	D2A		X				
	Defrost drain line	Solenoid for quick drain - pressurecontrol)	D1B and D4A			X			
	Valve in wet return/suction line	Solenoid 2-step (ICLX)	D3A				X		
	Fan	-	F01					X	

## Connections

### Supply Voltage:

Supply voltage depending on model: 85 – 265 V AC, 50/60 Hz.

Maximum power consumption: 20 V A 20 – 60 V DC and 24 V AC ± 15% 50/60 Hz

Maximum power consumption: 10 W, 17 V A

### MODBUS:

It is important that the installation of the data communication cable be done correctly. See separate literature. No. AN234886440486.

Remember termination at the bus termination.

### DO - Digital outputs, 8 pcs. DO1 - DO8:

Function defined via the HMI in the parameter list

#### DO1, DO2

Normally Open contact

10 A 250 V AC for resistive loads

3.5 A 230 V AC for inductive loads

#### DO3, DO4, DO7, DO8:

Changeover Contact,

6 A 250 V AC for resistive loads

4 A 250 V AC for inductive loads

#### DO5, DO6:

Solid state relays

Imax. = 0.5 A, Imin. = 50 mA

Leakage < 1.5 mA

Not short-circuit protected

OBSERVE: AC only - DC not allowed

Range: 24 – 230 V AC

**AO - Analogue output, 4 pcs. AO1, AO2, AO3, AO4**

Function defined via the HMI in the parameter list.

AO1, AO2:

0 / 10 V DC 10 mA max for each output

AO3, AO4:

Optoinsulated. 0 / 10 V DC 10 mA max for each output

External power supply 24 V AC / 24 V DC

OBSERVE:

Connect 24 V on N and L (separate supply). Avoid earth fault current. Use double-insulated transformer. The secondary side must not be earthed.

Obtain 0 – 10 volts from terminals N and AO3, respectively N and AO4.

PAY ATTENTION TO THE POLARITY of N.

**Table 36: AKS connections**

AKS 32R	AKS 32	AKS 33
10 – 90% ratiometric	1 – 5 V	0 – 20 mA, 4 – 20 mA

**AI - Analogue inputs, 4 pcs. AI1 - AI4**

Function defined via the HMI in the parameter list

*Pressure transmitters:*

- Ratiometric: 10-90% of supply, AKS 32R
  - 1 – 5 V, AKS 32
- 0 – 20 mA / 4-20 mA, AKS 33 (supply = 12 V)

*Temperature sensor:*

- Pt 1000 ohm, AKS 11 or AKS 21
- NTC 86K ohm @ 25 °C, from digital scroll

**DI - Digital inputs, 8 pcs. DI1 - DI8**

The connection may be a shut-down or interruption function. Select what is to be activated during configuration.

**AI - Analogue inputs, 4 pcs. AI5 - AI8**

Function defined via the HMI in the parameter list

*Pressure transmitters:*

- Ratiometric: 10 – 90% of supply, AKS 32R 1 – 5 V, AKS 32

*Temperature sensor:*

- Pt 1000 ohm, AKS 11 or AKS 21
- NTC 86K ohm @ 25 °C, from digital scroll

## Data

Table 37: Data

Features	Description
Supply voltage	24 V AC +/-15% 50/60 Hz, 17 VA 24 V DC (20 – 60 V), 17 VA 230 AC (85 – 265 V) 50/60 Hz, 20 VA
8 analog Input	Pressure measuring: Ratiometric pressure transmitter type AKS 32R 1 – 5 volt pressure transmitter type AKS 32 0 – 20 (4 – 20) mA pressure transmitter type AKS 33  Temperature measurement Pt 1000 ohm/0 °C NTC - 86K from digital scroll / stream
8 digital input	From contact function E.g. to: Start/stop of regulation Monitoring of safety circuits General alarm function
8 digital output	4 pcs. SPDT (8A) AC-1: 6 A (ohmic) AC-15: 4 A (inductive)
	2 pcs. SPST (16A) AC-1: 10 A (ohmic) AC-15: 3.5 (inductive)
	2 pcs. Solid State. PWM for solenoid coils and coils for AKV or AKVA. <b>OBSERVE:</b> 24-230 V AC, 50/60 Hz Imax. = 0.5 A Imin. = 50 mA Leak<1.5 mA Not short-circuit protected
2 Voltage output	0 – 10 V DC, Ri = 1 kohm Separate 24 V supply required
HMI	Remote HMI, type MMIGRS2
Data communication	MODBUS: Third party equipment like e.g PL CANBUS: Communication between EKE 400 units and HMI
Environments	-20 – 60 °C, During operations -40 – 70 °C, During transport  20 – 80% Rh, not condensed  No shock influence / vibrations
Enclosure	IP 20
Weight	0,4 kg
Mounting	DIN-rail
Connection terminals	max. 2.5 mm <sup>2</sup> multi core
Approvals	EU Low Voltage Directive and EMC demands re CE-marking complied with LVD tested acc. EN 60730-1 and EN 60730-2-9 EMC-tested acc. EN61000-6-2 and 3 UL approval

### Pressure transmitter / temperature sensor

Kindly refer to catalogue RK0YG...

### External display

A remote HMI is only for front assembly (IP 20)

Connection only via cable with plug. See [Ordering](#).

Figure 28: External display

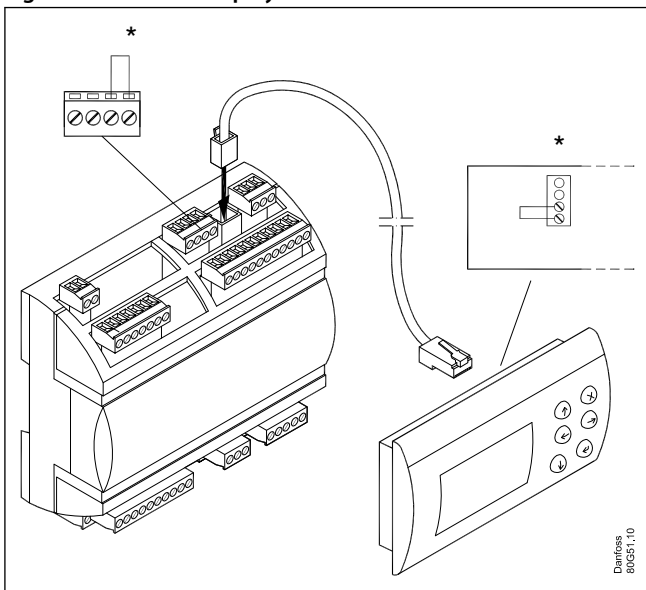

**IMPORTANT:**

\*Termination Connect H-R

**Mounting \ Dimensions**

Figure 29: Dimensions

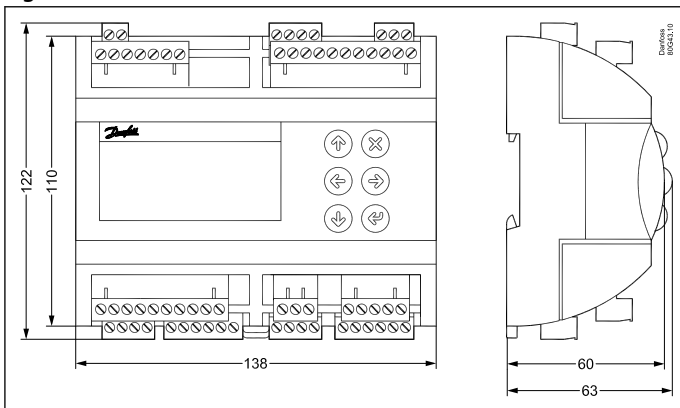

For DIN rail mounting only (IP 20)

**Installation considerations**

Accidental damage, poor installation, or site conditions, can give rise to malfunctions of the control system, and ultimately lead to a plant breakdown. Every possible safeguard is incorporated into our products to prevent this. However, a wrong installation, for example, could still present problems. Electronic controls are no substitute for normal, good engineering practice.

Danfoss will not be responsible for any goods, or plant components, damaged as a result of the above defects. It is the installer's responsibility to check the installation thoroughly, and to fit the necessary safety devices.

Your local Danfoss agent will be pleased to assist with further advice, etc.

## Appendix A

### Coordination of defrost

**No MODBUS or CANbus – Only DI/DO**

Figure 30: Coordination of defrost

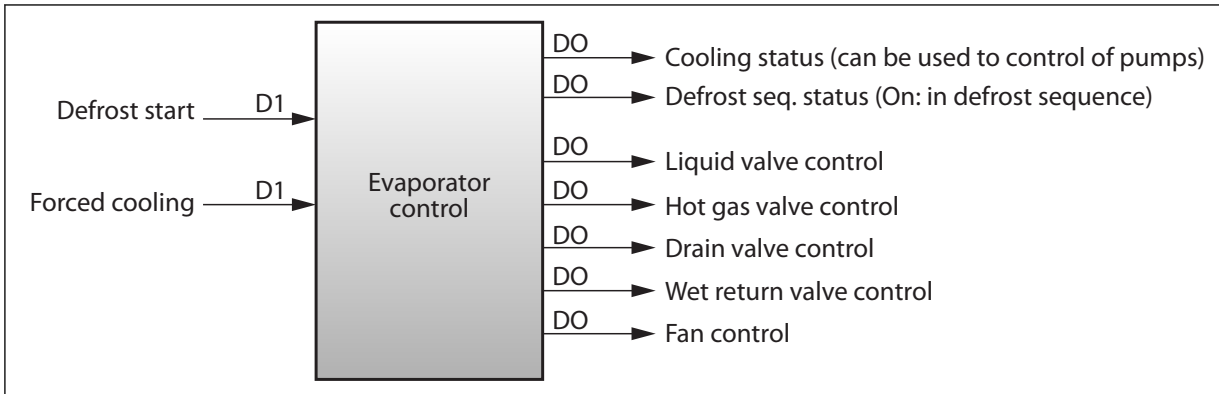

#### PLC

- The PLC starts the defrost via DI on the controller
- The PLC can set forced cooling via DI to the other controllers to secure enough hot gas, if needed
- The PLC can read the output signal 'Defrost seq. status' to check if a defrost has started as planned and to check when the defrost sequence has finished. Hereafter the next defrost can be started
- Alternative the PLC can start defrosting after a local start schedule only

#### Defrost start

- By defrost schedules
- Based on accumulated cooling time
- Fail-safe start if too long time has passed since last defrost
- Manual start (Local, DI or MODBUS)

#### NOTE:

If T09, Cool. status DO is set to Yes

If D08, Def. seq. status on DO is set to Yes

**No PLC. Alle EKE 400 connected via built-in CANbus**

Figure 31: No PLC. Alle EKE 400 connected via built-in CANbus

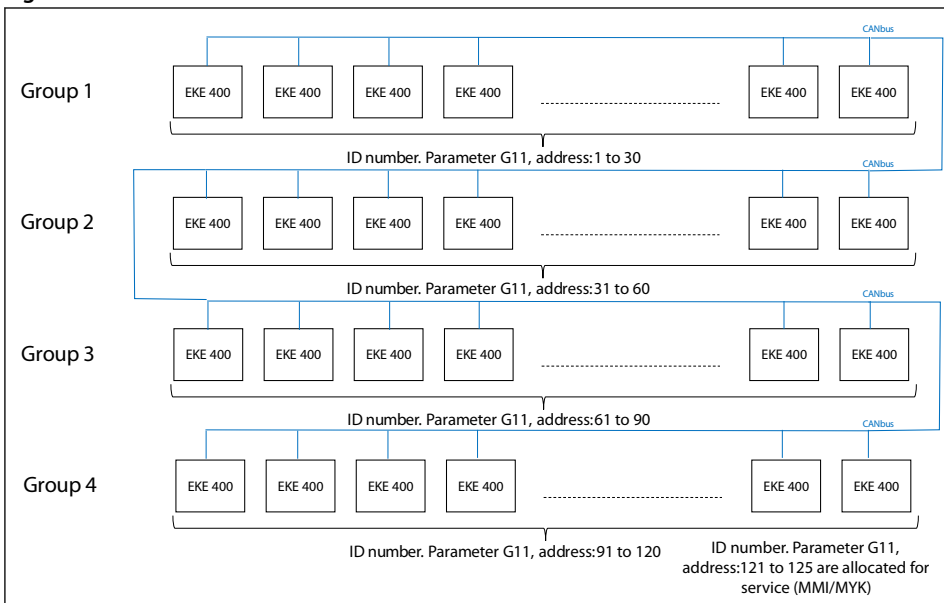

## Evaporator and room control, type EKE 400

### Master

- MASTER assigned to EKE 400 with the lowest ID number, in a group
- MASTER means that it will manage the Thermostat control and broadcast cooling ON/OFF signal to the other EKE 400 in the same group
- If MASTER enter defrost mode (see Defrost start below) then the EKE 400 with the second lowest ID number will become the MASTER, during defrost
- All EKE 400 has the parameter:D05, Cool at HG defrost
  - If D05 is set to Yes, the EKE 400, in question, will go into forced cooling when MASTER is in defrost mode

### Defrost start

- By defrost schedules
- Based on accumulated cooling time
- Fail-safe start if too long time has passed since last defrost
- Manual start (Local, DI or MODBUS)

Figure 32: Cool. status DO is set to Yes

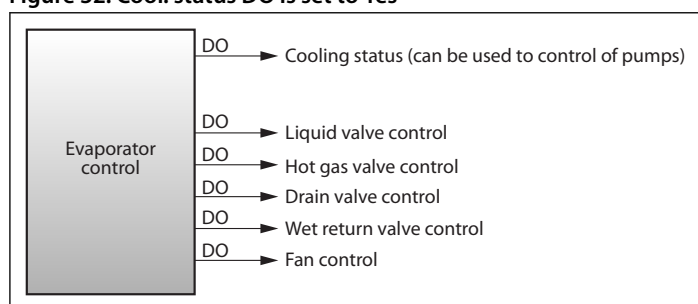

### NOTE:

If T09, Cool. status DO is set to Yes

## Appendix B

EKE 400 and EKE 1A - To support: ETS 6, ETS, KVS, ETS Colibri®, KVS Colibri®, CTR, CCMT valves

### Application example

Figure 33: Application example

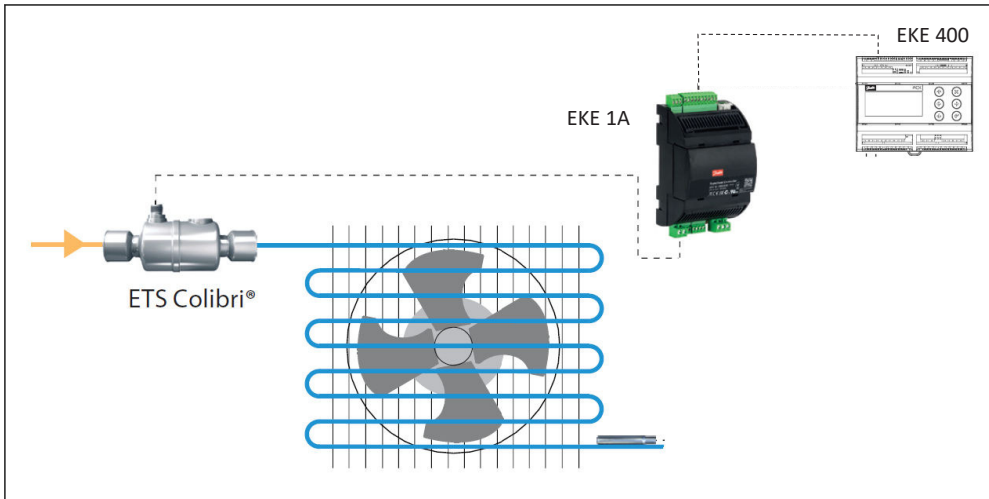

### Electrical connection

Figure 34: Electrical connection

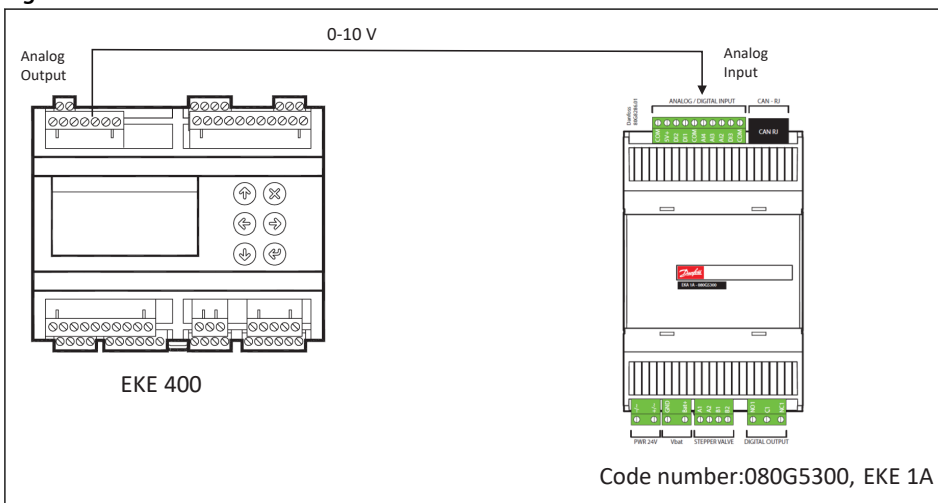
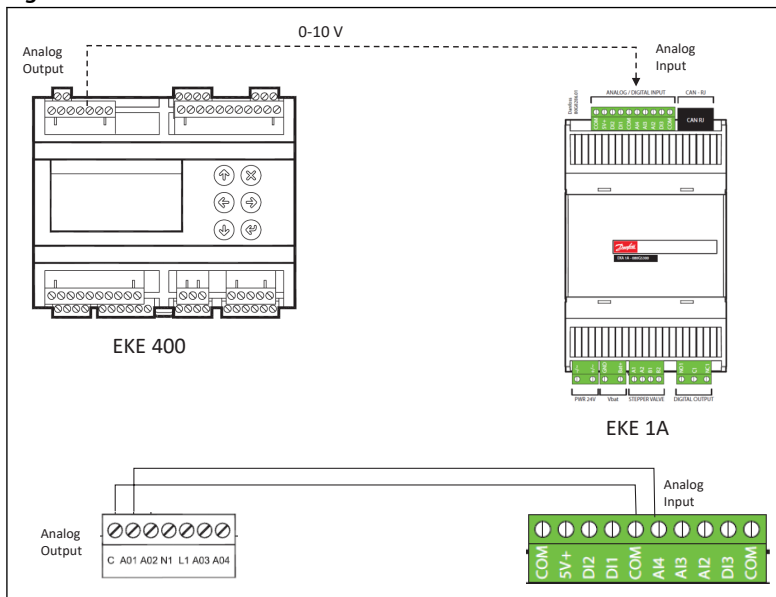



Figure 35: Electrical connection



**NOTE:**

In this example, analog output is assigned to AO1 on EKE 400.

**EKE 400 Configuration**

Figure 36: EKE 400 Configuration

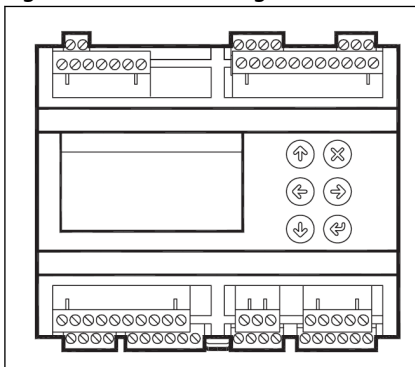

**When setting up EKE 400 to operate ETS 6, ETS, KVS, ETS Colibri®, KVS Colibri®, CTR, CCMT valves, via EKE 1A, below procedure must be followed**

- When selecting the valve on the EKE 400, always select: **ICM**
  - Example
    - Liquid Expansion Valve, DX
      - R2B, Liq. line valve for DX, to be set to 6: Mod ICM; Modulating motorized ICM
    - Hot gas line Valve
      - D2A, Hot gas line valve, to be set to 6: Slow (ICM): Motorized ICM, as slow opening/closing modulating valve
  - Remember to assign one AO (AO1 to AO4) after above selection

### EKE 1A Configuration

Figure 37: EKE 1A Configuration

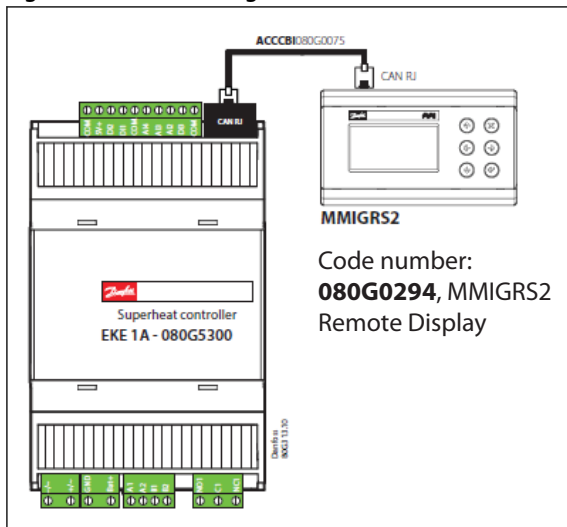

When setting up EKE 1A to operate ETS 6, ETS, KVS, ETS Colibri®, KVS Colibri®, CTR, CCMT valves, but controlled from EKE 400, below procedure must be followed. (Also described in EKE 1A Installation guide (page 12) [DKRCC.PI.RS0.B6.02](#))

- MMIGRS2, Remote display must be connected to EKE 1A, for setup
  - Parameter: I067 Valve configuration. Select actual valve type
  - Parameter: R102 Operation mode. Select:1=Valve driver
  - Parameter: I034 Ext ref voltage low. Enter:0
  - Parameter: I035 Ext ref. voltage high. Enter:10
  - Parameter R012 Main switch. Select: ON

## Appendix C

### Phase out of EKC 315A, EKC 361, EKC 366 to EKE 400

#### Dimension change

Figure 38: EKC 315A, EKC 361, EKC 366 vs EKE 400

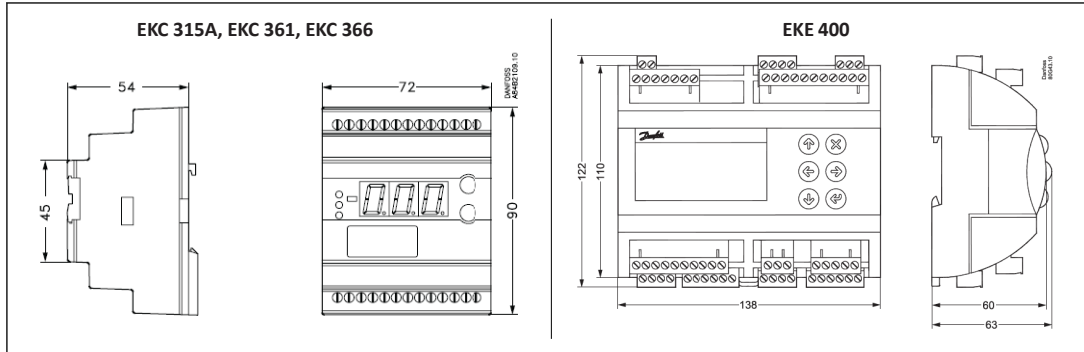

**NOTE:**

All dimension are in [mm]

#### Electrical differences

##### Analog output

- EKC 315A below include 0/4–20 mA output
  - 084B7249, EKC 315A
  - 084B7086, EKC 315A
- EKE 400 below include 0/2–10 V output
  - 080G5003, EKE 400 with HMI, 85–265 V AC, 50/60 Hz
  - 080G5004, EKE 400 with HMI, 20–60 V DC and 24 V AC ± 15% 50/60 Hz
  - 080G5005, EKE 400 without HMI, 85–265 V AC, 50/60 Hz
  - 080G5006, EKE 400 without HMI, 20–60 V DC and 24 V AC ± 15% 50/60 Hz

##### 0/2–10 V is accepted

Figure 39: Electrical differences - EKC 315A, EKC 361 vs EKE 400

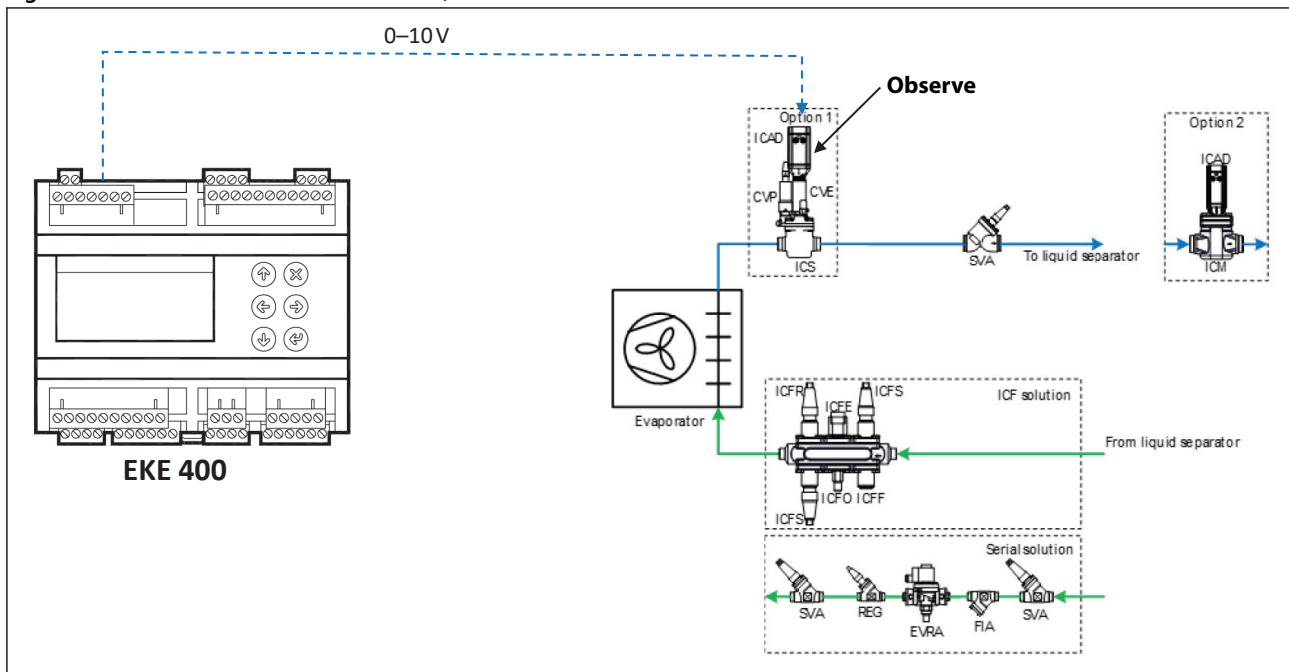

**NOTE:**

**Observe**

## Evaporator and room control, type EKE 400

ICAD setup to accept 0–10 V  
Parameter i03=4

### Work around if 4–20 mA is a requirement, and 0/2–10 V not accepted

Figure 40: Electrical differences - EKC 315A, EKC 361 vs EKE 400

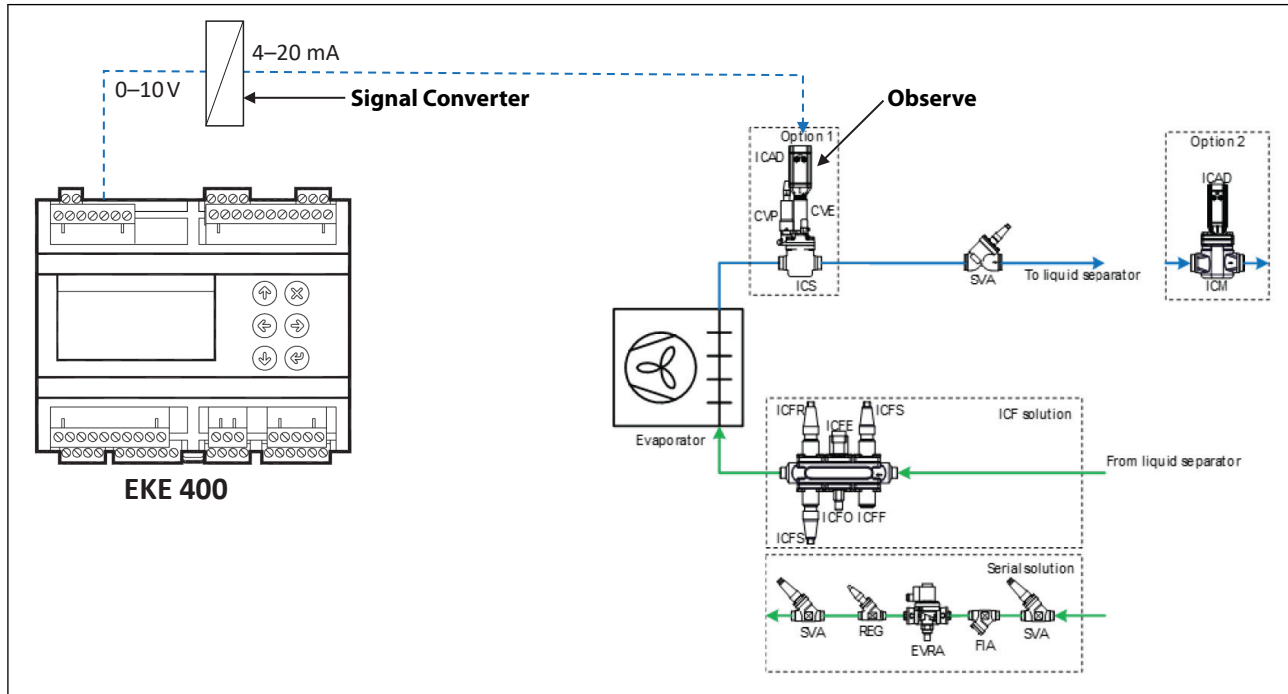

#### NOTE:

##### Observe

ICAD setup to accept 4–20 mA  
Parameter i03=2

##### Signal Converter

To be installed nearby EKE 400  
Convert 0–10 V to 4–20 mA

### General guideline for when it is recommended to change from 0/2–10 V to 4–20 mA

#### General

- When cable length exceeds 6 meter (20 feet) => change to 0/4–20 mA
- Use minimum wire gauge with minimum cross section of 0.82 mm<sup>2</sup>(18 AWG) for both 0/2–10 V and 4–20 mA control signals
- See tabel page 7

#### Max Distance

- 0/2–10 V
  - Maximum 6 meter (20 feet)
- 0/4–20 mA
  - Maximum 1000 meter (3281 feet)

### AWG (American Wire Gauge) / Cross Sectional Area (mm<sup>2</sup>)

Table 38: AWG (American Wire Gauge) / Cross Sectional Area (mm<sup>2</sup>)

American Wire Gauge (#AWG)	Diameter (inches)	Diameter (mm)	Cross Sectional Area (mm <sup>2</sup> )
1	0.289	7.35	42.4
2	0.258	6.54	33.6
3	0.229	5.83	26.7
4	0.204	5.19	21.1
5	0.182	4.62	16.8

## Evaporator and room control, type EKE 400

American Wire Gauge (#AWG)	Diameter (inches)	Diameter (mm)	Cross Sectional Area (mm <sup>2</sup> )
6	0.162	4.11	13.3
7	0.144	3.67	10.6
8	0.129	3.26	8.36
9	0.114	2.91	6.63
10	0.102	2.59	5.26
11	0.0907	2.3	4.17
12	0.0808	2.05	3.31
13	0.072	1.83	2.63
14	0.0641	1.63	2.08
15	0.0571	1.45	1.65
16	0.0508	1.29	1.31
17	0.0453	1.15	1.04
18	0.0403	1.02	0.82
19	0.0359	0.91	0.65
20	0.032	0.81	0.52
21	0.0285	0.72	0.41
22	0.0254	0.65	0.33
23	0.0226	0.57	0.26
24	0.0201	0.51	0.2
25	0.0179	0.45	0.16
26	0.0159	0.4	0.13

## Ordering

**Table 39: Ordering**

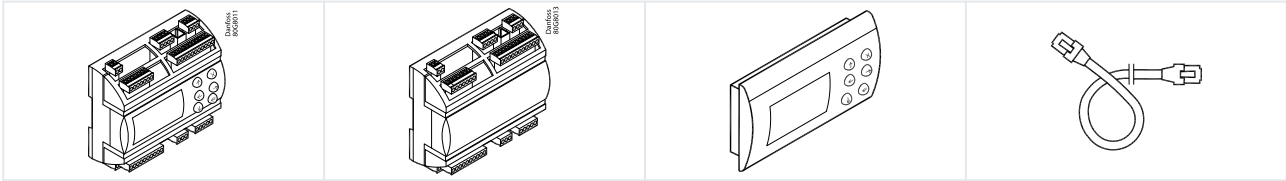

**Table 40: Ordering**

Type	Function	Operation	Supply voltage	Code no.
EKE 400	Evaporator controller	With HMI	230 V	080G5003
			24 V	080G5004
		Without HMI	230 V	080G5005
			24 V	080G5006
MMIGRS2	Remote HMI	For front panel mounting		080G0294
	Cable between remote HMI and EKE 400	L = 1.5 m, 1 pcs.		080G0075
	Cable between remote HMI and EKE 400	L = 3 m, 1 pcs.		080G0076

## Online support

Danfoss offers a wide range of support along with our products, including digital product information, software, mobile apps, and expert guidance. See the possibilities below.

### The Danfoss Product Store



The Danfoss Product Store is your one-stop shop for everything product related—no matter where you are in the world or what area of the cooling industry you work in. Get quick access to essential information like product specs, code numbers, technical documentation, certifications, accessories, and more.

Start browsing at [store.danfoss.com](https://store.danfoss.com).

### CoolConfig ensures problem-free copying and storing of settings



The CoolConfig tool allows the project engineer to generate the settings for the EKE 400 evaporator controller offline, and hand over the file to the commissioning engineer at the appropriate time for the installation on one or multiple EKE 400 evaporator controllers. It also allows the commissioning engineer to download the settings from an EKE 400 evaporator controller already installed at a job-site and modify and store these on a PC.

Can also be used to update EKE 400 to latest released Software.

See: <https://www.danfoss.com/en/service-and-support/downloads/dcs/coolconfig/#tab-overview>.

### Find technical documentation



Find the technical documentation you need to get your project up and running. Get direct access to our official collection of data sheets, certificates and declarations, manuals and guides, 3D models and drawings, case stories, brochures, and much more.

Start searching now at [www.danfoss.com/en/service-and-support/documentation](https://www.danfoss.com/en/service-and-support/documentation).

### Get local information and support



Local Danfoss websites are the main sources for help and information about our company and products. Find product availability, get the latest regional news, or connect with a nearby expert—all in your own language.

Find your local Danfoss website here: [www.danfoss.com/en/choose-region](https://www.danfoss.com/en/choose-region).

### Danfoss Learning



Danfoss Learning is a free online learning platform. It features courses and materials specifically designed to help engineers, installers, service technicians, and wholesalers better understand the products, applications, industry topics, and trends that will help you do your job better.

Create your Danfoss Learning account for free at [www.danfoss.com/en/service-and-support/learning](https://www.danfoss.com/en/service-and-support/learning).

### Coolselector® 2 - find the best components for you HVAC/R system



Coolselector® 2 makes it easy for engineers, consultants, and designers to find and order the best components for refrigeration and air conditioning systems. Run calculations based on your operating conditions and then choose the best setup for your system design.

Download Coolselector® 2 for free at [coolselector.danfoss.com](https://coolselector.danfoss.com).

### Danfoss A/S

Climate Solutions • [danfoss.com](https://danfoss.com) • +45 7488 2222

Any information, including, but not limited to information on selection of product, its application or use, product design, weight, dimensions, capacity or any other technical data in product manuals, catalogues descriptions, advertisements, etc. and whether made available in writing, orally, electronically, online or via download, shall be considered informative, and is only binding if and to the extent, explicit reference is made in a quotation or order confirmation. Danfoss cannot accept any responsibility for possible errors in catalogues, brochures, videos and other material. Danfoss reserves the right to alter its products without notice. This also applies to products ordered but not delivered provided that such alterations can be made without changes to form, fit or function of the product.

All trademarks in this material are property of Danfoss A/S or Danfoss group companies. Danfoss and the Danfoss logo are trademarks of Danfoss A/S. All rights reserved.