

Data Sheet

RA-IN radiator valves with integrated presetting

Application

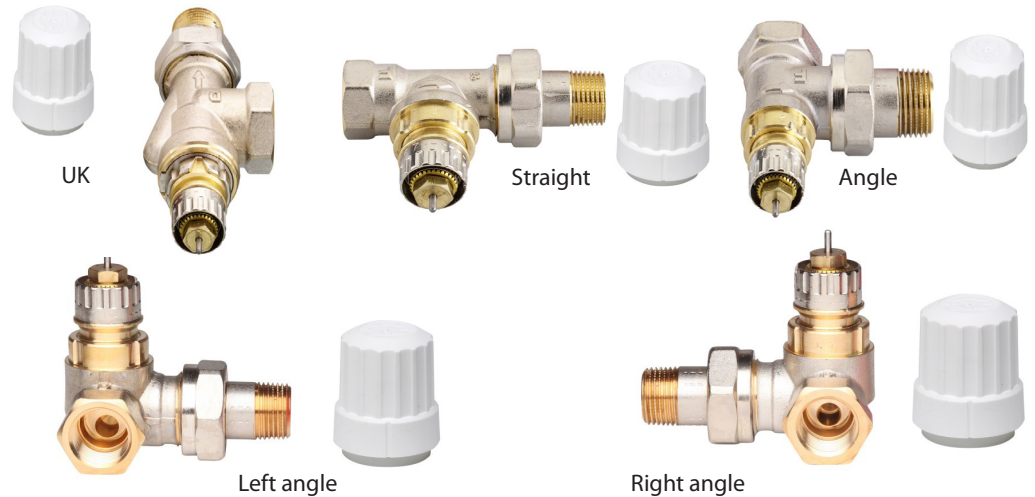

RA-IN valves are designed to work in conjunction with thermostatic sensor to deliver energy savings.

RA-IN valve bodies can be used together with all types of thermostatic sensors in Danfoss RA-series, like Danfoss Aero®, React™, Redia®, Regus®, RAX, Eco and Connect electronic thermostats and with TWA thermal actuators.

RA-IN valves are used in two-pipe heating systems. They are designed to fit with Danfoss fitting range. A comprehensive range of compression fittings for PEX, AluPEX, copper and steel tubes are available.

RA-IN valves are delivered in 'N' position which is fully open. RA-N valves are fitted with a k_v limiting device for pre-setting of max. water flow and are available with the following setting ranges:

RA-IN 10:	$k_v = 0.05 - 0.56 \text{ m}^3/\text{h}$
RA-IN 15:	$k_v = 0.058 - 0.73 \text{ m}^3/\text{h}$
RA-IN 20/25:	$k_v = 0.14 - 1.04 \text{ m}^3/\text{h}$

Each valve body is supplied with a white protective cap, which can be used for manual regulation during the construction phase. The protective cap must not be used as a manual shut off device.

A special manual shut off device is available as an accessory. RA-IN valve bodies are manufactured from brass with nickel plating.

The pressure pin of the gland seal is of chromium steel and works in a lifetime lubricated O-ring. The complete gland seal assembly can be replaced without draining down the system.

In order to avoid deposition and corrosion the composition of the hot water must be in accordance with the VDI 2035 guideline (Verein Deutscher Ingenieure).

It is recommended that formulations containing mineral oil are avoided.

Approved to EN 215



Danfoss RA-IN valves are manufactured to the highest standards, and are approved to the European Standard EN 215. All Danfoss radiator thermostats are manufactured in factories, assessed and certified by BVC (Bureau Veritas Certification) against ISO 9001 and ISO 14001.

Presetting

The presetting values of RA-IN valves can be adjusted easily and accurately without the use of tools (factory setting = N):

- Remove protective cap / thermostatic sensor
- Find reference mark
- Lift and turn setting ring until the aquired presetting aligns with the reference mark.

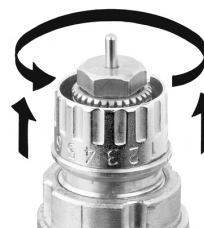

Presetting can be selected in steps from 1 to 4 . At setting N the valve is fully open. This setting can be used as a flushing position, if the system has to be flushed out because of dirt problems. In one-pipe installations, the setting N must be used.

Settings outside 1 to 4 and N should be avoided.

When the thermostatic sensor has been installed, the presetting is protected against unintended regulation.

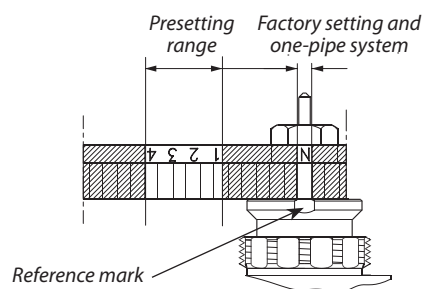

Data and ordering

Type	Design	Connections		Pre-setting						Max. work. press. bar	Max. diff. ²⁾ press. bar	Test bar	Max. work. temp. °C	Code no
		Inlet	Out-let	$k_v^{1)}$ (m ³ /h at $\Delta p = 1$ bar)					k_{vs}					
		Rp	R	1	2	3	4	N	N					
RA-IN 10	Angle	3/8	3/8	0.053	0.11	0.23	0.36	0.56	0.65	10	0.6	16	120	013G6581
	Straight													013G6582
	Right angle													013G6571
	Left angle													013G6572
	UK													013G6591
RA-IN 15	Angle	1/2	1/2	0.058	0.12	0.26	0.43	0.73	0.90	10	0.6	16	120	013G6583
	Straight													013G6584
	Right angle													013G6573
	Left angle													013G6574
	UK													013G6593
RA-IN 20	Angle	3/4	3/4	0.14	0.20	0.38	0.76	1.04	1.40	10	0.6	16	120	013G6585
	Straight													013G6586
	UK													013G6595
RA-IN 25	Angle	1	1	0.14	0.20	0.38	0.76	1.04	1.40	10	0.6	16	120	013G6587
	Straight													013G6588

¹⁾ The k_v -value indicates the water flow (Q) in m³/h at a pressure drop (Δp) across the valve of 1 bar; $k_v = Q: \sqrt{\Delta p}$. At setting N the k_v -value is stated according to EN 215, at $X_p = 2K$ i.e. the valve is closed at 2°C higher room temperature. At lower settings the X_p value is reduced to 0.5K of the setting value 1. The k_{vs} -value states the flow Q at a maximum lift, i.e. at fully open valve at setting N.

²⁾ Working pressure = static + differential pressure. The maximum differential pressure specified is the maximum pressure at which the valves give satisfactory regulation. As with any device which imposes a pressure drop in the system, noise may occur under certain flow/pressure conditions. To ensure quiet operation, maximum pressure drop should not exceed 30 to 35 kPa. The differential pressure can be reduced by the use of the Danfoss differential pressure regulators.

Accessories

Product	Dimension	For valve body	Code no.
Gland seal	-	All RA valves	013G0290
Compression fitting for steel and copper tubes	Rp 3/8 x Ø10 mm	RA-IN 10	013G4100
	Rp 3/8 x Ø12 mm		013G4102
	Rp 1/2 x Ø10 mm	RA-IN 15	013G4110
	Rp 1/2 x Ø12 mm		013G4112
	Rp 1/2 x Ø14 mm		013G4114

All accessories comes in boxes of 10 pcs.

Operating principle

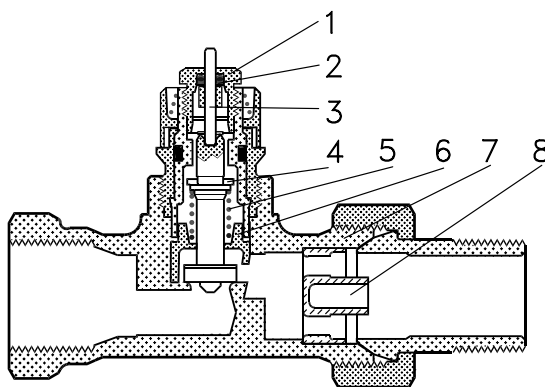

- 1. Gland seal
- 2. O-Ring
- 3. Pressure pin
- 4. Seal
- 5. Regulation spring
- 6. Setting dial
- 7. Valve body
- 8. k_v -nozzle

Valve body and other metal parts	Ms 58, brass
K_v -limiter	PPS
O-ring	EPDM
Valve cone	NBR
Pressure pin and valve spring	Chrome steel
Nozzle	PP

Max. ambient temperature	60 °C
Max. medium temperature	120 °C
Max. working pressure	10 bar
Test pressure	16 bar

The valve bodies are nickle-plated on the outside.

Principles

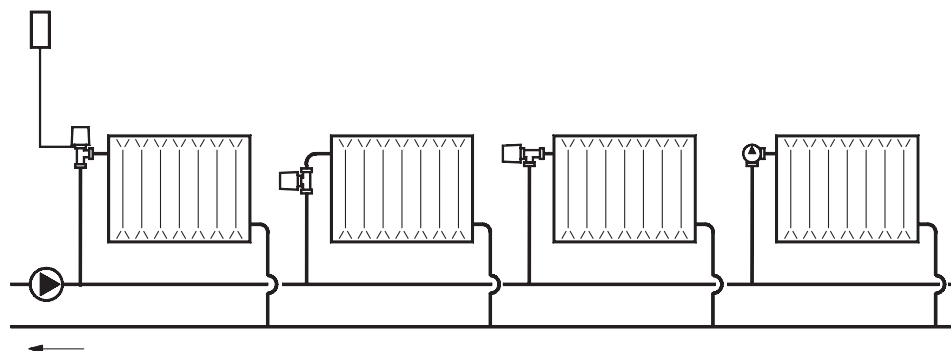

RA-IN 10

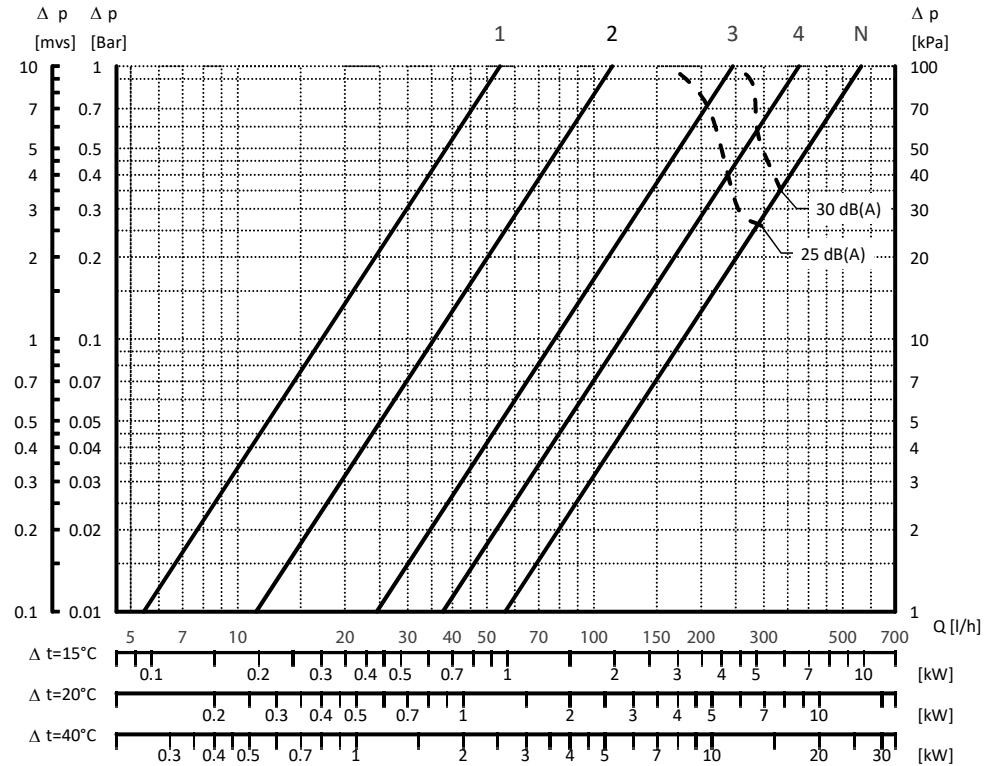

RA-IN 15

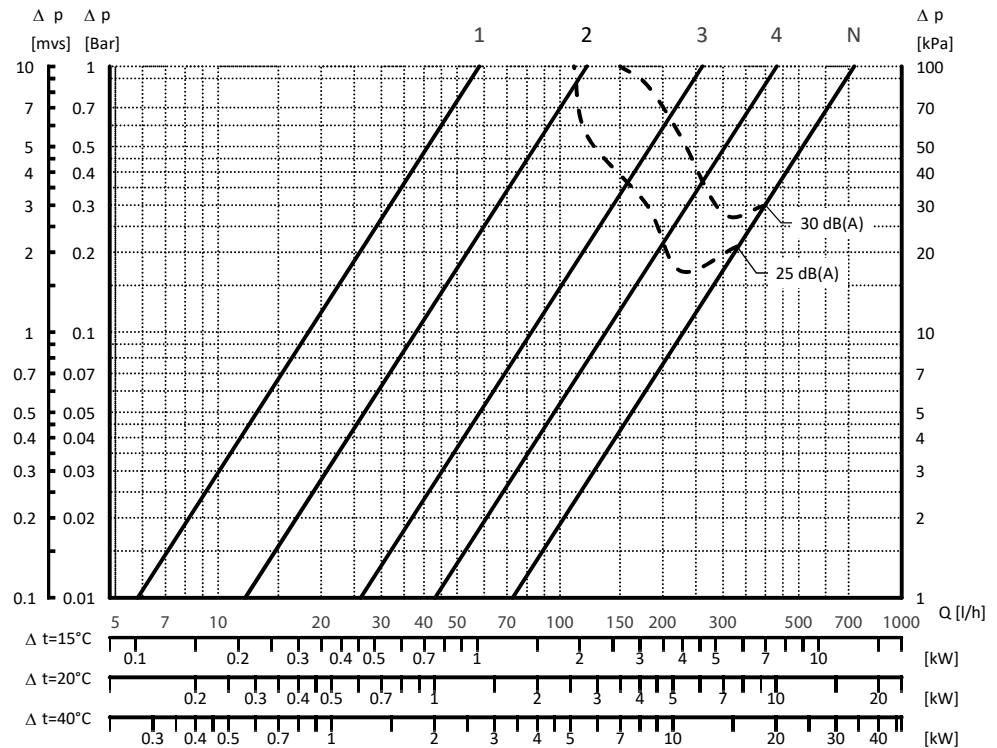

RA-IN 20/25

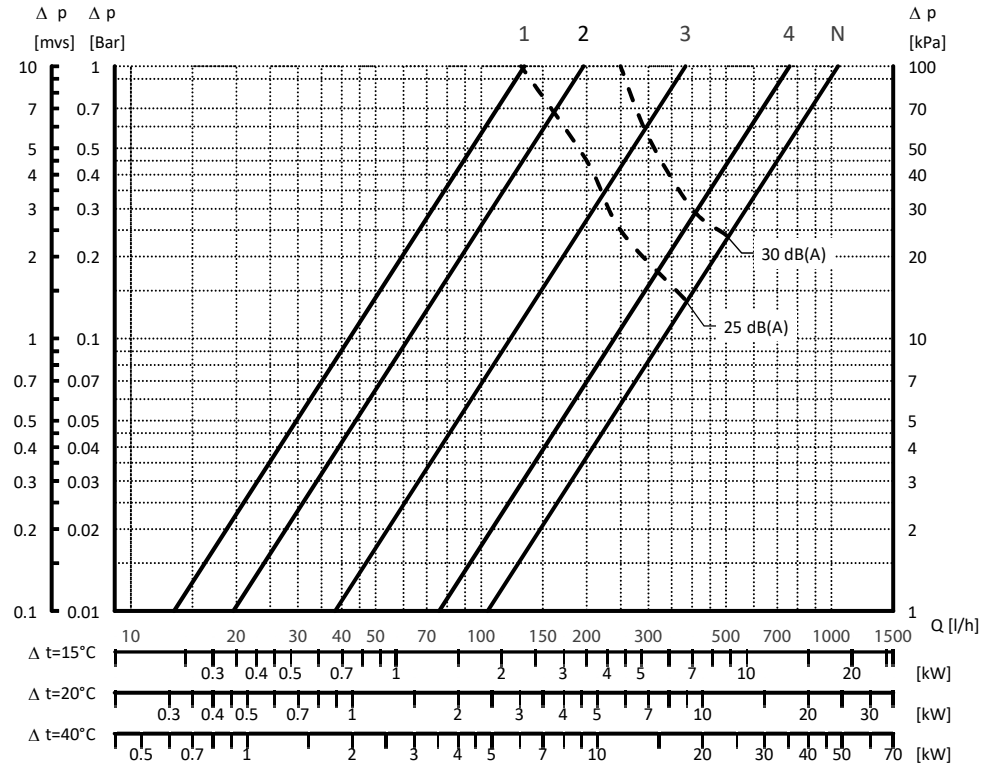

RA-IN 20 (UK)

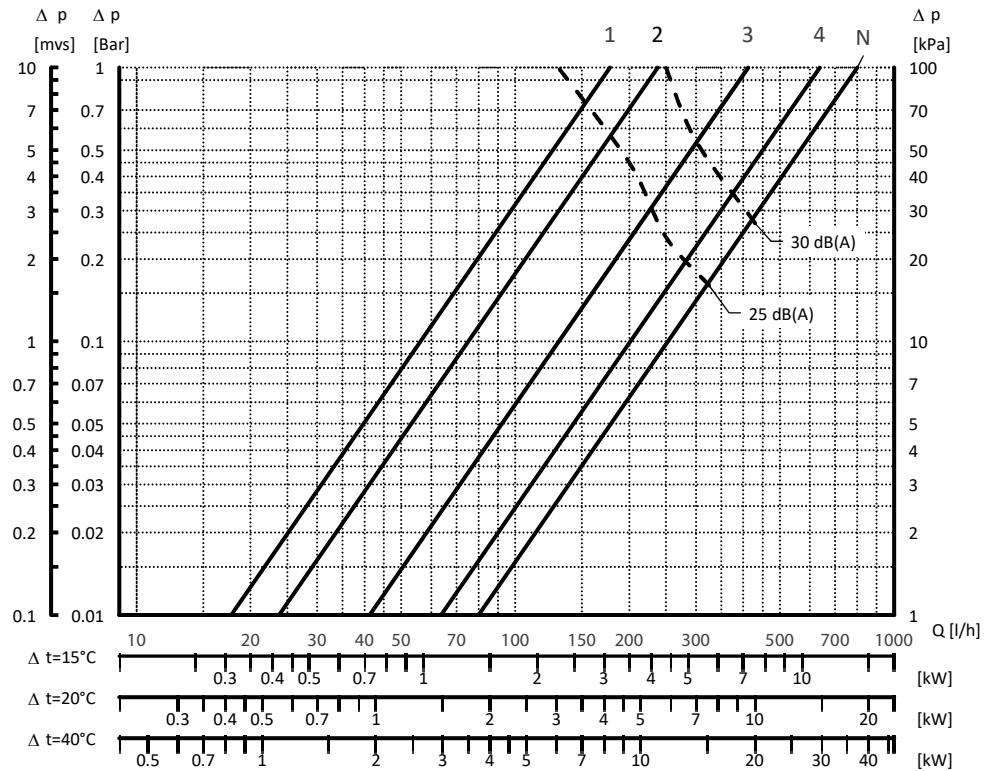

Note:

As with any device which imposes a pressure drop in the system, noise may occur under certain flow/pressure conditions. To ensure quiet operation, maximum pressure drop should not exceed 30-35 kPa (3-3,5 mwg).

Sizing example:

Required heat:	1.6 kW	
Cooling across radiator:	20° C	
Flow through radiator:	$Q = \frac{1.6}{20 \times 1.16} = 0.07 \text{ m}^3/\text{h} = 0.70 \text{ l/s}$	
Pressure drop across valve:	$\Delta p = 1 \text{ mwg}$	
Valve setting:	RA-N 10	3
	RA-N 15	3
	RA-N 20/25	3

Alternatively the setting can be read directly in the table "Data and Ordering".

$$k_v = \frac{Q \text{ (m}^3/\text{h)}}{\sqrt{\Delta p \text{ (bar)}}$$

Construction

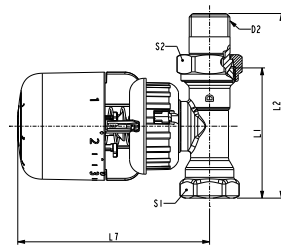

Straight valve with sensor Danfoss Aero®

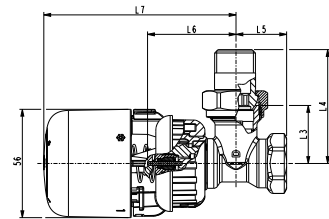

Angle valve with sensor Danfoss Aero®

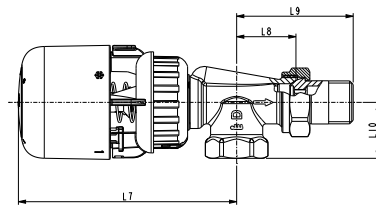
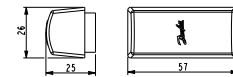

Horizontal angle valve with sensor Danfoss Aero®

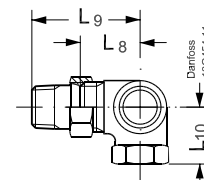

Side angle valve

Type	ISO 7-1			L ₁	L ₂	L ₃	L ₄	L ₅	L ₆	L ₇	L ₈	L ₉	L ₁₀	Arc. flats	
	DN	D	d ₂											S ₁	S ₂
RA-IN 10	10	R _p 3/8	R 3/8	50	75	24	49	20	47	98	27	52	22	22	27
RA-IN 10 UK	10	R _p 3/8	R 3/8						59	110	26	51	22	22	27
RA-IN 15	15	R _p 1/2	R 1/2	55	82	26	53	23	47	98	30	58	26	27	30
RA-IN 15 UK	15	R _p 1/2	R 1/2						60	110	29	57	27	27	30
RA-IN 20	20	R _p 3/4	R 3/4	65	98	30	63	26	52	103				32	37
RA-IN 20 UK	20	R _p 3/4	R 3/4						61	112	34	66	30	32	37
RA-IN 25	20	R _p 1	R 1	90	125	40	75	35	52	103				41	46

Danfoss A/S

Heating Segment • heating.danfoss.com • +45 7488 2222 • E-Mail: heating@danfoss.com

Danfoss can accept no responsibility for possible errors in catalogues, brochures and other printed material. Danfoss reserves the right to alter its products without notice. This also applies to products already on order provided that such alterations can be made without subsequential changes being necessary in specifications already agreed. All trademarks in this material are property of the respective companies. Danfoss and all Danfoss logotypes are trademarks of Danfoss A/S. All rights reserved.