

ENGINEERING
TOMORROW



Americas

Aeroquip[®]

Rubber hydraulic hose
and fitting catalog

by Danfoss



Aeroquip® by Danfoss Stronger than ever.

For decades, Aeroquip has moved the industry forward. Uncovering problems to be solved. Never settling for the status quo. Now, backed by the power of Danfoss, we're making major investments in product innovation, expanding manufacturing capabilities, supporting you with a world-class team. And we're just getting started.



Industry
leading
fluid
conveyance



product overview

Section	Page
Introduction	
Hose selection chart	6
STAMPED worksheet	12
Two-Tier product portfolio	28
Premium hydraulic hose	
Core premium braided & spiral hose	39
Premium braided & spiral hose	54
Standard braided & spiral hose	78
Braided fittings	
Premium - 1A fittings	85
Field attachable - 1R/2R fittings	145
Standard - Winner™ fittings	171
Spiral fittings	
Premium - 4S/6S series	185
Premium - 1W series	237
Flange, Flange kit, O-Rings	241
Hose accessories	
Sleeves, clamps & springs	249
Accessories to hose chart	258

Section	Page
Machines & tooling	
Crimp machines	269
Tooling	289
Pumps	292
Conversion kits	296
Field attachable machines	298
Hose prep	
Saws & saw blades	304
Skiving tools	310
Hose proof test stands	312
Contamination control	314
Cabinets & storage	
Danfoss branded cabinets	331
Safety information	
Hose safety	335
Hose selection	338
Fluid compatibility	344
Analyzing failures	355
Fluid connections	358
Assembly instructions	376
Maintenance	380
Glossary & index	
Glossary	387
Index	392

Explore the world of

From thermoplastic hose to data center connections, Danfoss has the hose, fittings and connectors that work.

Connectors



- Product Categories:
- Brass Connectors
 - Steel Adapters
 - Flexmaster
 - Swivels
 - FLOCS
 - Tube Fittings
 - Quick Disconnect Couplings

Fuel, air conditioning, thermoplastic & specialty (FACTS)



- Product Categories:
- A/C & Refrigeration
 - Silicone
 - Airbrake
 - Socketless
 - Beverage Tubing
 - Specialty
 - Engine/Fuel
 - Subsea Oil & Gas
 - Performance Products
 - Thermoplastic
 - PTFE
 - Railway

Industrial hose



- Product Categories:
- Air & Multipurpose
 - Chemical
 - Food & Beverage
 - Material Handling
 - Oil & Petroleum
 - Specialty
 - Steam
 - Water

Rubber hydraulic hose & fittings (RHHF)



- Product Categories:
- Braided Hose & Fittings
 - Spiral Hose & Fittings
 - Tools, Machines & Accessories

Hose selection chart

How to use chart: Locate the hose I.D. required and move to the right to the correct pressure. Then move up or down in this column for data on material, temperature, etc. to quickly determine whether the hose meets your requirements.

For complete information on any hose refer to hose catalog page number.

Core hoses are indicated with icons:



Selection of hose: Selection of the proper hose for the application is essential to the proper operation and safe use of the hose and related equipment. Inadequate attention to selection of the hose for your application can result in hose leaking, bursting, or other failure which can cause serious bodily injury or property damage from spraying fluids or flying projectiles. You should carefully review the information in this catalog.

Hose selection chart									
Hose	GH681	FC839B	GH194	GH781	EC881	FC735	GH195	GH120	
Page	39	40	41	42	43	44	45	46	
Usage	✓+	⚙️	🌡️	✓	✓	⚙️	🌡️	🌡️	
	Low to medium pressure hydraulic & water-based fluids	Medium pressure hydraulic & water-based fluids in abrasive applications	Hydraulics, crude, fuel and lubricating oils, gasoline, water and phosphate ester base hydraulic fluids	Transfer of medium to high pressure hydraulic & water-based fluids	Hydraulic system with petroleum and water glycol based fluids for lubricating oils	For high pressure hydraulics subjected to high surge peaks	Hydraulics, crude, fuel and lubricating oils, gasoline, water and phosphate ester base hydraulic fluids	Low temperature hydraulic system service with petroleum and water-based fluids, for general industrial service.	
Certifications									
SAE	SAE 100R17 SAE 100R1	SAE 100R17	SAE 100R1	SAE 100R16	SAE 100R16 SAE 100R19	SAE 100R16	SAE 100R2	SAE 100R16	
EN	EN 857 1SC performance		EN 853	EN 857 2SC	EN 857 2SC	EN 857 2SC	EN 853 2SN	EN 857 2SC	
ISO	ISO 1436 1SN ISO 18752	ISO 18752		ISO 18752	ISO 18752 ISO 11237	ISO 18752 ISO 11237	ISO 1436	ISO 11237-1	
OTHER	ABS MSHA DNV USCG	MSHA	ABS MSHA DNV	ABS MSHA DNV USCG	ABS MSHA DNV	ABS MSHA DNV	ABS MSHA DNV USCG	MSHA	
Hose Specifications									
Temp Range	-46° to 126° C -50° to 260° F	-40° to 100° C -40° to 212° F	-40° to 150° C -40° to 302° F	-46° to 126° C -50° to 260° F	-46° to 126° C -50° to 260° F	-40° to 100° C -40° to 260° F	-40° to 150° C -40° to 302° F	-57° to 100° C -70° to 212° F	
Fittings	1A Series 1R Series	1A Series	1A Series	1A Series 2R Series	1A Series	1A Series	1A Series	1A Series	
Hose Construction									
Inner Tube	Nitrile	Nitrile	AQP High-Temp	Nitrile	Dura-Pulse	Nitrile	AQP	Nitrile	
Reinforcement	1 wire braid	1 wire braid or 2 wire braid	1 wire braid	2 wire braid	2 wire braid	2 wire braid	2 wire braid	2 wire braid	
Cover	Dura-Tuff	Bruiser	AQP	Dura-Tuff	Dura-Tuff	Bruiser	AQP	Rubber Cover	
DASH	HOSE ID	GH681	FC839B	GH194	GH781	EC881	FC735	GH195	GH120
-4	1/4	3,700	3,050	3,250	6,500	6,525	6,500	5,800	6,000
-6	3/8	3,400	3,050	3,125	5,800	5,800	5,800	5,000	5,000
-8	1/2	3,200	3,050	2,550	5,000	5,220	5,000	4,250	4,500
-10	5/8	2,025	3,050	2,050	4,000	5,075	4,000	3,650	4,000
-12	3/4	2,000	3,050	1,800	3,500	4,785	3,500	3,125	3,500
-16	1	1,500	3,050	1,300	3,000	4,060	3,000	2,550	2,800
-20	1-1/4	1,000		950	2,500	2,500	2,500	2,250	2,300
-24	1-1/2	750		725	2,000	2,000		1,800	2,000
-32	2	600		580	1,600	1,600		1,525	1,500
-40	2-1/2								
-48	3								
-64	4								

Hose selection chart

How to use chart: Locate the hose I.D. required and move to the right to the correct pressure. Then move up or down in this column for data on material, temperature, etc. to quickly determine whether the hose meets your requirements.

For complete information on any hose refer to hose catalog page number.

Core hoses are indicated with icons:



Hose selection chart								
Hose	GH493	FC736	EC525	FC500	FC273B	EC810	EC600	
Page	47	48	49	50	51	52	53	
Usage	✓+	⊘	🌡️	✓+	⊘	🌡️	✓+	
	Hydraulic system service with petroleum and water based fluids, for general use.	High abrasion industrial and hydraulic system applications with petroleum and water-based fluids	Petroleum and fire-resistant hydraulic fluids, fuel and lubricating oils, gasoline, water and other industrial fluids	High pressure hydraulic system service with petroleum and water-based fluids, for general industrial service.	Hydraulic system service with petroleum and water-based fluids, for general use	Hydraulic system service with petroleum based fluids for use in cold environments.	High pressure hydraulic system service with petroleum and water-based fluids, for general industrial service	
Certifications								
SAE	SAE 100R12	SAE 100R12		SAE 100R13	SAE 100R13	SAE 100R15	SAE 100R15	
EN	EN 856 R12	EN 856 R12		EN 856 R13	EN 856 R13	EN 856 4SH performance	EN 856 4SH EN 85 R13	
ISO	ISO 18752 ISO 3862 R12	ISO 18752		ISO 3862 R13 ISO 18752	ISO 3862 R13 ISO 18752		ISO 18752	
OTHER	ABS DNV MSHA USCG	ABS DNV MSHA USCG	DNV MSHA	DNV MSHA USCG	MSHA	MSHA	ABS DNV MSHA USCG	
Hose Specifications								
Temp Range	-40° to 126° C -40° to 260° F	-40° to 121° C -40° to 250° F	-40° to 149° C -40° to 300° F	-40° to 127° C -40° to 260° F	-40° to 121° C -40° to 250° F	-57° to 100° C -70° to 212° F	-40° to 127° C -40° to 260° F	
Fittings	4S Series	4S Series	4S Series	4S Series 6S Series	4S Series 6S Series	4S Series 6S Series	4S Series 6S Series 1W Series	
Hose Construction								
Inner Tube	Nitrile	Nitrile	AQP High Temp	Nitrile	Nitrile	Nitrile	Nitrile	
Reinforcement	4 wire spiral	4 wire spiral	4 wire spiral	4 wire spiral or 6 wire spiral	4 wire spiral or 6 wire spiral	4 wire spiral or 6 wire spiral	4 wire spiral or 6 wire spiral	
Cover	Dura-Tuff	Bruiser	AQP	Dura-Tuff	Bruiser	Rubber Cover	Dura-Tuff	
DASH	HOSE ID	GH493	FC736	EC525	FC500	FC273B	EC810	EC600
-4	1/4							
-6	3/8	6,500	5,500				6,100	
-8	1/2	6,000	5,000				6,100	
-10	5/8	6,000	5,000				6,100	
-12	3/4	5,500	4,050	5,000	5,100	5,100	6,100	6,100
-16	1	5,100	4,050	5,000	5,100	5,100	6,100	6,100
-20	1-1/4	4,500	3,050	3,500	5,100	5,100	6,100	6,100
-24	1-1/2	4,000	2,550	3,500	5,100	5,100	6,100	6,100
-32	2	4,000	2,550	3,250	5,100	5,100	6,100	6,100
-40	2-1/2							
-48	3							
-64	4							

Hose selection chart

How to use chart: Locate the hose I.D. required and move to the right to the correct pressure. Then move up or down in this column for data on material, temperature, etc. to quickly determine whether the hose meets your requirements.

For complete information on any hose refer to hose catalog page number.

Core hoses are indicated with icons:

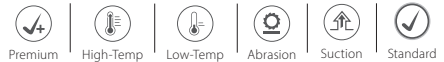

Hose selection chart

Hose	FC639	GH663	FC849	FC849B	FC510	GH793	FC611	
Page	54	55	56	57	58	59	60	
Usage	System service with petroleum and water-base fluids. Recommended for high-pressure oil lines.	Hydraulic systems with petroleum and water-glycol base fluids, for lubricating oils and water.	Industrial and hydraulic system applications with petroleum and water-based fluids. Recommended for use on construction, forestry, and other off-highway vehicles	Ultra-abrasion industrial and hydraulic system applications with petroleum and water-based fluids. Recommended for use on critical applications in construction, forestry, and other off-highway vehicles	Petroleum and fire-resistant hydraulic fluids, fuel, and lubricating systems.	Hydraulic system service with petroleum & water-based fluids, for general industrial service.	Ground support equipment (GSE), industrial phosphate esterbased fluids, water glycol systems.	
Certifications								
SAE	SAE 100R17	SAE 100R1	SAE 100R19 Performance	SAE 100R19 Performance	SAE 100R2	SAE 100R2		
EN		EN 8583 1SN Performance			EN 857 1SC	EN 853 2SN performance		
ISO	ISO 18752	ISO 1436 1SN				ISO 1436 2SN		
OTHER	MSHA	ABS DNV MSHA USCG	ABS, MSHA USCG	MSHA	DNV MSHA USCG	ABS MSHA USCG		
Hose Specifications								
Temp Range	-40° to 127° C -40° to 260° F	-46° to 126° C -50° to 260° F	-40° to 100° C -40° to 212° F	-40° to 100° C -40° to 212° F	-40° to 149° C -40° to 300° F	-40° to 126° C -40° to 260° F	-40° to 79° C -40° to 175° F	
Fittings	1A Series	1A Series	1A Series	1A Series	1A Series	1A Series 2R Series (size dependent)	1A Series	
Hose Construction								
Inner Tube	Nitrile	Nitrile	Nitrile	Nitrile	AQP elastomer	Nitrile	EPDM	
Reinforcement	1 wire braid or 2 wire braid	1 wire braid	2 wire braid	2 wire braid	1 wire braid	2 wire braid	1 wire braid	
Cover	Dura-Tuff	Dura Tuff	Dura-Tuff	Bruiser	AQP High-Temp	Dura-Tuff	EPDM Rubber	
DASH	HOSE ID	FC639	GH663	FC849	FC849B	FC510	GH793	FC611
-4	1/4	3,050	3,700	4,000	4,000	5,000	6,500	
-6	3/8	3,050	3,400	4,000	4,000	4,000	5,800	
-8	1/2	3,050	2,900	4,000	4,000	3,500	5,000	2,000
-10	5/8	3,050	2,050	4,000	4,000	2,750	4,000	
-12	3/4	3,050	2,000	4,000	4,000	2,250	3,500	1,250
-16	1	3,050	1,500			2,000	3,000	1,000
-20	1-1/4		1,000			1,625	2,500	625
-24	1-1/2		750				2,000	500
-32	2		600				1,600	375
-40	2-1/2							
-48	3							
-64	4							

Hose selection chart

How to use chart: Locate the hose I.D. required and move to the right to the correct pressure. Then move up or down in this column for data on material, temperature, etc. to quickly determine whether the hose meets your requirements.

For complete information on any hose refer to hose catalog page number.

Core hoses are indicated with icons:

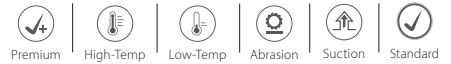

Hose selection chart								
Hose	FC693	EC502	FC579	EC230	FC254	GH506	FC606	
Page	61	62	63	64	65	66	67	
Usage	Ground support equipment (GSE), industrial phosphate esterbased fluids, water glycol systems.	General hydraulics Agricultural equipment – turf care Vocational fleets – mobile refuse, mobile cement mixers Manufacturing – stationary machining centers	Hydraulic jacking system service with petroleum and water-base fluids. Meets the performance requirements of the MSHA IJ100.	Hydraulic system service with petroleum and waterbased fluids, for general industrial service	Hydraulic system service with petroleum or water based fluids, for general industrial use	Hydraulic systems with petroleum and water-glycol based fluids, for lubricating oils and water	High-pressure hydraulics, hydrostatic transmissions.	
Certifications								
SAE		SAE 100R2		SAE 100R2			SAE 100R15	
EN		EN 853 2SN			EN 856 4SP	EN 856 4SH		
ISO						ISO 3862 4SH ISO 18752	ISO 3862 R15	
OTHER		MSHA	MSHA IJ100	MSHA	MSHA	ABS DNV MSHA	ABS MSHA	
Hose Specifications								
Temp Range	-40° to 79° C -40° to 175° F	-40° to 100° C -40° to 212° F	-40° to 49° C -40° to 120° F	-40° to 100° C -40° to 212° F	-40° to 126° C -40° to 260° F	-40° to 100° C -40° to 212° C	-40° to 121° C -40° to 250° F	
Fittings	1A Series	3L Series	1A Series	Nipple: FC8251 Socket: FC1346	4S Series 1W Series	1W Series 4S Series	6S series	
Hose Construction								
Inner Tube	EPDM	Nitrile	Nitrile	Nitrile	Nitrile	Nitrile	Nitrile	
Reinforcement	2 wire braid	2 wire braid	2 wire braid	2 wire braid	4 wire spiral	4 wire spiral	6 wire spiral	
Cover	EPDM Rubber	Dura-Tuff	Dura-Tuff	Dura-Tuff	Dura-Tuff	Dura-Tuff	Dura-Tuff	
DASH	HOSE ID	FC693	EC502	FC579	EC230	FC254	GH506	FC606
-4	1/4	5,000		10,000				
-6	3/8	4,000		10,000				
-8	1/2	3,500	4,250			7,700		
-10	5/8							
-12	3/4		3,125			7,200	6,100	
-16	1		2,500			6,000	6,100	
-20	1-1/4					5,100	5,100	
-24	1-1/2					4,350	4,350	6,100
-32	2					4,000	3,650	
-40	2-1/2				1,150			
-48	3							
-64	4							

Hose selection chart

How to use chart: Locate the hose I.D. required and move to the right to the correct pressure. Then move up or down in this column for data on material, temperature, etc. to quickly determine whether the hose meets your requirements.

For complete information on any hose refer to hose catalog page number.

Core hoses are indicated with icons:

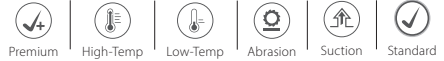

Hose selection chart							
Hose	GH466	FC636	EC850	EC910	FC619	2661	
Page	68	69	70	71	72	73	
Usage	High pressure hydraulic systems with constant high working pressure for use with petroleum based fluids.	Ground support equipment (GSE), industrial phosphate ester based fluids, water glycol systems.	Ultra high pressure applications, hydraulic systems with petroleum and water-glycol based fluids, lubricating oils and water.	Waterblast service with water, water-soap emulsion exceeds ISO 7751 requirements	 Suction and transfer applications for petroleum hydraulic fluids, fuel, lubricating oils, gasoline, water and many other industrial fluids.	Suction and transfer applications for petroleum and fire resistant hydraulic fluids, fuel, lubricating oils, gasoline, water and many other industrial fluids.	
Certifications							
SAE	SAE 100R15	SAE 100R12	SAE 100R15		SAE 100R4	SAE 100R4	
EN	EN 856 R13		EN 856 R13		EN 45545		
ISO	ISO 18752		ISO 18752	ISO 7751			
OTHER	ABS DNV MSHA		MSHA	MSHA	ABS MSHA USCG	ABS MSHA USCG	
Hose Specifications							
Temp Range	-40° to 121° C -40° to 250° F	-40° to 79° C -40° to 175° F	-40° to 100° C -40° to 212° F	-40° to 93° C -40° to 200° F	-40° to 135° C -40° to 275° F	-40° to 150° C -40° to 300° F	
Fittings	1W Series 6S Series	4S Series	1W Series	-8: EJ5892 -12 & -16: 1W Series	1A Series 1G Series 4S Series	1A Series 1G Series	
Hose Construction							
Inner Tube	Nitrile	EPDM	Nitrile	Nitrile	AQP	AQP	
Reinforcement	6 wire spiral	4 wire spiral	4 wire spiral or 6 wire spiral	4 wire spiral	2 fiber ply with helical wire	2 fiber ply with helical wire	
Cover	Dura-Tuff	EPDM Rubber	Dura-Tuff	Rubber	Dura-Tuff	AQP High-Temp	
DASH	HOSE ID	GH466	FC636	EC850	EC910	FC619	2661
-4	1/4						305
-6	3/8						255
-8	1/2				16,000		205
-10	5/8			7,250			160
-12	3/4		4,000	7,250	14,500	305	100
-16	1		4,000	7,250	10,200	245	65
-20	1-1/4	6,100	3,000	7,250		205	60
-24	1-1/2	6,100	2,500			150	50
-32	2	6,100				100	
-40	2-1/2					60	
-48	3					60	
-64	4						

Hose selection chart

How to use chart: Locate the hose I.D. required and move to the right to the correct pressure. Then move up or down in this column for data on material, temperature, etc. to quickly determine whether the hose meets your requirements.

For complete information on any hose refer to hose catalog page number.

Core hoses are indicated with icons:



Hose selection chart							
Hose	EC115	EC215	EC118	EC415	EC420	WH004	
Page	78	79	80	81	82	83	
Usage							
	Hydraulic system service with petroleum and water-based fluids and general industrial service.	Hydraulic system service with petroleum and water-base fluids, for general industrial service.	Hydraulics, gasoline, air, crude, fuel and lubricating oils	Hydraulic systems service with petroleum and water based fluids, for general use.	Suitable for use in hydraulic systems with high peak pressures and arduous operating conditions.	Suitable for use in suction applications for hydraulics, crude fuel, lubricating oils, gasoline, air, water and chemical transfer	
Certifications							
SAE	SAE 100R1		SAE 100R17	SAE 100R12	SAE 100R13	SAE 100R4 Performance	
EN	EN 857 1SC (-4 to -16)	EN 857 2SC		EN 856 R12	EN856 R13		
ISO		18752	18752	18752	18752		
OTHER	DNV MSHA USCG	DNV MSHA USCG	MSHA USCG	MSHA USCG	DNV MSHA USCG	MSHA	
Hose Specifications							
Temp Range	-40° to 100° C -40° to 212° F	-40° to 100° C -40° to 212° F	-40° to 100° C -40° to 212° F	-40° to 121° C -40° to 250° F	-40° to 121° C -40° to 250° F	-40° to 100° C -40° to 212° F	
Fittings	1A Series 2 pc Winner 1R Series	1A Series 2 pc Winner 2R Series	1A Series 2 pc Winner 1R Series (-4 to -8)	4S Series	4S Series 6S Series	1A Series, 1G Series, 2 pc Winner Series & 4T Optimum	
Hose Construction							
Inner Tube	Nitrile	Nitrile	Nitrile	Nitrile	Nitrile	Nitrile	
Reinforcement	1 wire braid	2 wire braid	1 wire braid or 2 wire braid	4 wire spiral	4 wire spiral or 6 wire spiral	2 fiber ply with helical wire	
Cover	Nitrile	Nitrile	Nitrile	Nitrile	Nitrile	Abrasion-resistant nitrile	
DASH	HOSE ID	EC115	EC215	EC118	EC415	EC420	WH004
-4	1/4	3,250	5,800	3,050			
-6	3/8	2,600	5,000	3,050	4,050		
-8	1/2	2,300	4,000	3,050	4,050		
-10	5/8	1,900	3,650	3,050	4,050		
-12	3/4	1,525	3,125	3,050	4,050	5,100	305
-16	1	1,275	2,400	3,050	4,050	5,100	245
-20	1-1/4	925	1,800		3,050	5,100	205
-24	1-1/2	725	1,450		3,000	5,100	150
-32	2	580	1,300		3,000	5,100	100
-40	2-1/2						60
-48	3						60
-64	4						

worksheet

Danfoss recommends using the **STAMPED** process to aid in determining the correct hose and coupling for your application. This worksheet is designed to help you organize information for determining the best hose for a given application. The questions are based on the hose selection factors described in this guide.

When selecting a hose, always use this worksheet in conjunction with this guide. Read all instructions concerning the hose you are selecting. If any questions arise contact Danfoss technical support at 1-888-258-0222.

STAMPED

S - Size

(I.D., O.D. and length)

T - Temperature of

material conveyed and environmental

A - Application,

the conditions of use

M - Material being

conveyed, type and concentration

P - Pressure to which

the assembly will be exposed

E - Ends; style, type,

orientation, attachment methods, etc.

D - Delivery testing,

quality, packaging, and delivery requirements

Flow (cubic feet per minute) requirements? _____

See RMA Water Discharge table.

Hose I.D. requirements given the flow requirements? _____

Pressure drop? _____

Length requirements (excluding hose ends)? _____

Temperature range of material to be transferred?

Min. _____ Max. _____ Average _____

Year-round external environment temperature range? _____

Cleaning temperature?

If the application is new, what service is to be performed?

Internal and external environment consideration. Internal environment relates to the material being conveyed. External environment relates to anything originating from outside the hose.

Check all that apply.

Abrasive materials (conveyants and external)

Ozone

Petroleum products (aromatics, aliphatics, etc)

Acids/caustics

Materials that could cut or gouge hose

Animal fats (oils)

Solvents

Sparking or flames

Cleaning with steam

Material to be transferred? _____

Material concentration (%)? _____

What hose cleaning solution(s) will be used? _____

If you have any questions, please contact Danfoss Technical Support at 1-888-258-0222.

What working pressure is required? _____

Are pressure surges involved in this application? How high? _____

What safety factor is required? _____

Is this a suction application? What vacuum rating is required? _____

End _____

Material _____

Attachment Method _____

Qty. required _____ Date required _____ Pkg. requirements _____

Testing Required - No Yes If Yes, Type: _____

Certification Required - No Yes If Yes, Type: _____

Will the selected hose need to possess any of the following features:

Branding information needed on the hose? _____

Color coding? _____

Any special designations required by agencies or associations? _____

Will any regulatory agency approvals be required? If yes, which one(s)? _____

Non-conductive rubber needed to prevent transmittal of electricity? _____

Static wire or static-dissipating tube to prevent static electricity buildup and discharge sparks? _____

Pin-pricked cover to resist blistering when transferring hot materials or air/gases under pressure? _____

Abrasion sleeve or guard? _____

Heat shield? _____

Sub-zero exposure resistance? _____

Special assembly requirements? _____

Continuous transfer service or intermittent service? _____

Flexibility: Do space restrictions exist where the hose will be used? _____

Bend Radius: of the hose relative to space in which hose will be used? _____

Considering the intended use of the hose, how flexible will it need to be (check one)?

Extremely flexible Slightly flexible Not an issue

Weight: How will the hose be handled during use, if at all? _____

How important is the weight of the hose going to be in this application (check one)?

Very important Slightly important Not an issue

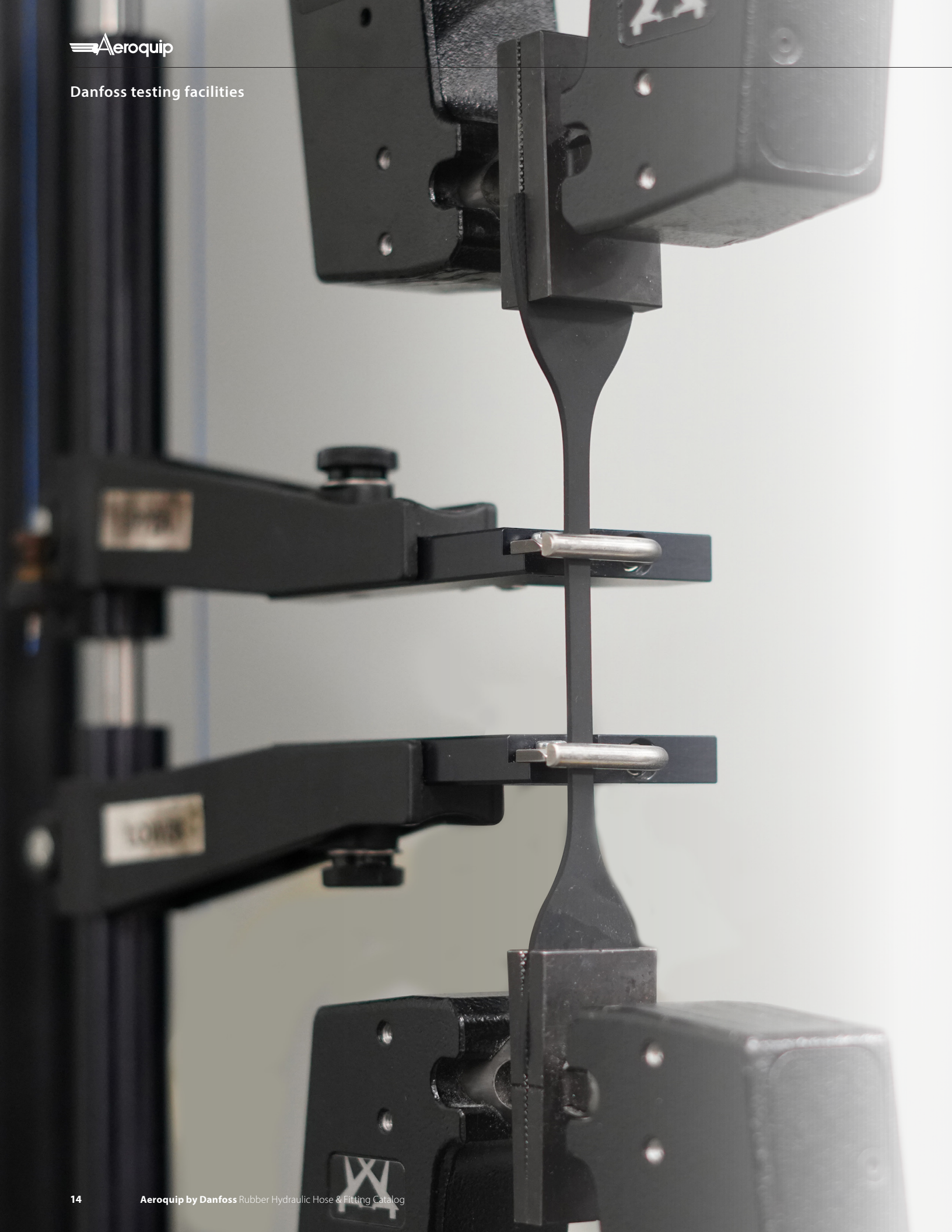

Danfoss

Where innovation and technology meet



App

A Product Applications Engineer is responsible for performing a wide variety of engineering and technical tasks. They review all customer product specifications, including drawings, contracts, and project details. They are the main technical resources throughout the sales process. The Product Applications Engineer identifies and designs complex products and solutions, determining manufacturing feasibility and costs for specific customer applications and quotations.

Eng

The Engineering Lab is a place of learning and discovery for our technical team. This area includes our current crimp machine line up where we can build test samples and prove out new products and tooling on our crimp equipment. It also includes two of our 3D printers that we use for rapid prototypes, proving designs and developing new methods of manufacturing components. There is also space to perform product tear downs, review and analysis as well as machining capabilities for custom tooling, fixtures and cutaways.

Env

Fluid Conveyance Products are exposed to many harsh environments and we need to be able to duplicate some of these conditions. Environmental chambers are machines we use to simulate extreme temperature, humidity, vibration, flexing and pressurization conditions. The environmental room is filled with six environmental chambers with varying capabilities. While all the chambers can be programmed with a high/low temperature profile, two of the chambers have vibration capabilities, one has a mechanical

flex capability and two have humidity capabilities. Environmental testing is performed to either industry specifications, customer specifications or internally developed test protocols. As an added feature, a power unit can be brought to the chambers to perform impulse testing while at varying environmental conditions.

Our ISO/TS 16949 approved and A2LA certified Test Lab provides a suitable environment to conduct laboratory testing in support of new product development, ongoing customer support and internal continuous improvement activities. Our staff includes experienced Technicians, Hydraulics Systems experts, Electrical expertise, LabView expertise, in house Gauging and Calibration, Quality and Maintenance. We are fully capable of designing and developing all our test equipment from simple test fixtures to complex impulse machines.

The machines within this area are designed to perform the core hose tests of impulse and burst. Impulse testing is a fatigue test where hose is repeatedly exposed to high pressure pulses for a high number of cycles while at its highest operating temperature and smallest bend radius. These extreme conditions ensure hoses meet endurance requirements. Burst is a one time pressure test where hose is taken to failure and required to meet a 4 to 1 safety factor. Other testing that takes place in this area includes vibration, tensile, volumetric expansion and air brake flex testing. While not as common as burst and impulse, these tests are needed to support the vast array of industries that the Fluid Conveyance product lines serve.

The Maumee Materials Science laboratory offers the formulation development of novel thermoset and thermoplastic elastomers alongside expertise in testing, chemical compatibility and QC analysis.

The ovens that occupy most of this room's floor space are utilized for a variety of high temperature tests including high temperature aging, hot oil circulation, high temperature impulse and high temperature burst. Testing to these protocols ensures our products will perform even when run at their extreme rated operating temperatures.

Abrasion to a hose cover will expose the steel reinforcement wires causing corrosion and eventually hose failure. The Fluid Conveyance product group offers a variety of hose covers from entry level low abrasion resistance to premium products that offer very high abrasion resistance. To characterize the abrasion resistance of a hose cover, we use an abrasion tester designed to run testing per ISO-6945.

Salt spray is another standardized test protocol run in this room to test plating corrosion resistance. Plating is a significant factor for Fluid Conveyance because most of our fitting and adapter product lines are Zinc plated steel.

The Maumee Pilot Plant generates prototype hose based on engineering specifications and used in the Concept Assessment and Design Suitability stages of development.

Danfoss term

Danfoss brand definitions

Premium brand hose

Used exclusively for Aeroquip high-temp hose; constructed with patented elastomer materials

Ultra-abrasion resistant hose cover; 700x greater abrasion resistance than industry standard

Plating technology offering three times the **corrosion protection** on carbon steel fittings, compared to competitive hose fittings – up to 1000 hours of corrosion protection. Used on premium fitting series such as 1A, Z and 4S/6S series.

A patented **inner-tube** compound providing five times longer life than standard 2SC hoses. It is slow to age and has a low compression set, which provides better sealing and leak free performance

Patented innovation that eliminates the hose assembly **cool-down leakage**, while extending hose assembly life and reducing equipment downtime

Premium **abrasion**-resistant hose cover; 8x greater resistance than the industry standard

Ultra-performance, premium hose offering **high pressure capabilities** with extended life and 50% better **bend radius** than EN standard

Special braided hose construction type. FC310 and FC510 are examples. Additional wire is added into the braided reinforcement to allow for higher pressures. Mining hose

A monitoring system that detects impending hydraulic hose failure and alerts operators and maintenance crews so they can schedule maintenance and plan downtime. The system continuously monitors hose condition via electrical signals and generates an alert when the hose starts to experience internal fatigue.

System that matches hose to fittings.

Braided-Match number of rings (O) on layline with number of rings on fitting

Spiral-Match either 4S or 6S on layline with corresponding mark on fitting

Braided & Spiral-Match hose dash size with size on fitting

Specialized fitting that provides an o-ring seal at the face of the fitting designed to eliminate leaks in high pressure systems

Standard tier brand hose & fittings

Spiral hose offering 50% of SAE R13/R15 **bend radius** in demanding **high impulse** applications

Fitting definitions

Aeroquip one-piece fitting series' name for core, braided hose products. It corresponds with the printing on both the hose layline and fitting. "Through the cover" (TTC) is a legacy series' name. Suitable for use on premium and standard products

Premium series' name for "over-the-cover" (OTC) style fitting

Premium field attachable fitting series' name for one and two-wire braided hose products. Suitable for use on premium and standard products

Premium internal skive, two-piece fitting series' name for select core spiral hoses used to achieve a higher level of performance. Suitable for use on premium and standard products

Premium one-piece fitting series' name for core spiral hose products. Suitable for use on premium and standard products

High pressure fitting series' that makes hose line connection quick and easy, without the need for assembly tools

Standard tier fitting series. Does not use dura-kote plating technology. Suitable for use on standard products and selectively on premium products

Non-skive standard tier fitting series. Does not use Dura-Kote plating technology. Suitable for use on standard products and selectively on premium products

Industry terms

A term used to describe non-field attachable fitting component parts or complete assemblies for braided and spiral hoses. Core series are: 1A, 1G, 4S and 6S

A fitting designed to be attached to a hose without crimping or swaging. This fitting is not always a reusable type fitting

A device attached to the end of the hose to facilitate connection. "Hose-end" and "coupling" are equivalent terms in the industry

The maximum pressure for which the hose assembly is designed. Note: "operating pressure" is an equivalent term but should not be used in copy

The portion of the fitting that goes directly into the inner diameter of the inner tube of the hose. It extends out of the hose and into the connecting end. Also known in the industry as a "stem" or "insert"

Refers to hose and fitting combinations that does not require removing part of the hydraulic hose cover and/or inner tube prior to attaching fittings. Also known in the industry as "no-skive"

The portion of a fitting that is compressed by crimping to seal the hose onto the fitting barbs and create a permanent attachment. Also known as "collar" and "ferrule" in the industry

Key fluid conveyance terms

Hose series reinforced with a single steel braid

Hose series reinforced with two steel braids

Hose series reinforced with four wires

Hose Series reinforced with six wires

Defines the level of abrasion-resistance a cover offers. Danfoss has three levels: standard, premium (Dura-Tuff) and ultra (Bruiser)

Danfoss' designated term for premium core products with a max temperature rating of at least 150°C (300°F)

Danfoss' designated term for premium core products with a max temperature rating of at least -57°C (-70°F)

Products that **exceed** industry specifications. For Danfoss, distinctions from standard tier are made with abrasion resistance, temperature range, impulse cycles and ISO 18752 rating

Products that **meet** industry specifications

Active products that tend to be used for more niche applications

Danfoss

TM

Your information headquarters



Putting fluid conveyance information at your

1. Searchable fluid conveyance product information:
 - Part numbers
 - Sizes
 - Performance and specifications
 - Branding information
2. Literature and videos
3. Product value propositions
4. Crimp specifications
5. Competitor cross reference tool
6. Coupling cross reference tool
7. Custom bin label tool
8. 2D/3D cad models
9. Hose assembly configurator
10. Marketplace (authenticated PowerSource only)
11. List prices and lead times (authenticated PowerSource only)

To access these tools and more, visit and log in to PowerSource from [Danfosspowersource.com](https://danfosspowersource.com) and then select tools.

Custom bin labels

Get your custom bin labels today!

Danfoss has created a solution for all your instant bin label needs from the convenience of your office in just four simple steps.

- 1 **Select template**
Choose the template.
- 2 **Enter part numbers**
Enter part numbers OR upload your own file of part numbers.
- 3 **Choose the layout**
Configure label with or without barcode.
- 4 **Print label set**
Generate a PDF to preview and print your label set.

For best results use the product code FF00000, available through Taylor Communications. Individual labels are 2 9/16" x 11/16".

This custom bin label web solution can be found at: Danfosspowersource.com > PowerSource > Tools > Custom Bin Labels





The screenshot shows the 'Custom Bin Labels' web application. At the top, there is a navigation bar with 'Distributor Locator', 'PowerSource Training', and 'Login' links. Below this is a search bar with 'AMER • English' selected. The main content area is titled 'Custom Bin Labels' and includes a 'Product Code: FF00000' banner. The interface is divided into four steps: Step 1: Select Template (with a dropdown menu), Step 2: Enter Part Numbers (with 'Enter a List' and 'Upload List' options), Step 3: Choose Layout (with 'Barcode' and 'No Barcode' options), and Step 4: Print Label Set (with a 'Generate PDF for Preview/Print' button).

Fitting options

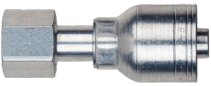

Standard and premium fittings -

Braided or spiral, premium or standard, there is a Danfoss fitting designed for your application.

<p>Braided hose fittings</p>	<p>Features:</p>
<p>1A braided fittings</p> 	<ul style="list-style-type: none"> • Dura-Kote™ plating technology for up to 1,000 hours of corrosion resistance • Bite the wire technology for best in class connection and sealing • Class zero leakage SAE J1176 on approved hose styles • Over 550 1A series part numbers available • Danfoss' MatchMate® program provides identification markings on the hose, hose fittings, and crimp dies for quick and easy assembly
<p>Two-piece Winner fittings</p> 	<ul style="list-style-type: none"> • Non-skive, two-piece crimp fitting • One nipple part number for EC115, EC215 and EC118 standard hoses • Meets industry specifications when used with the EC115, EC215 and EC118 standard hoses • Clear silver hexavalent chromium-free plating • Carbon steel material
<p>Spiral hose fittings</p>	<p>Features:</p>
<p>4S/6S spiral fittings</p> 	<ul style="list-style-type: none"> • Dura-Kote plating technology for up to 1,000 hours of corrosion resistance • Danfoss patent-pending Dura-Seal™ technology eliminates hose assembly cool-down leakage • Class zero leakage SAE J1176 on approved hose styles • Danfoss' MatchMate spiral-hose/fitting identification system program provides identification markings on the hose, hose fittings, and crimp dies for quick and easy assembly
<p>1W internal skive spiral fittings</p> 	<ul style="list-style-type: none"> • Internal skive high-performance spiral fitting with design-related sockets • Blow-off prevention for critical applications • Designed to withstand high-pressure environments, with a capacity of up to working 500 bar (7250 psi). • Tested to two million flex impulse cycles, proving their durability and reliability over the long-term. • Class 0 cool down leakage per SAE J1176 • Double O-ring Dura-Seal for sizes -20 to -32 providing extra protection and durability for large size hoses.
<p>Field attachable hose fittings</p>	<p>Features:</p>
<p>Field attachable fittings</p> 	<ul style="list-style-type: none"> • Dura-Kote plating technology for up to 1,000 hours of corrosion resistance • Engineered to provide peak performance with Danfoss' core braided hose products • Can be assembled in the field without special tooling • Reduced downtime • Quick repair

Dura-Kote and Dura-Seal technology



3X Carbon steel corrosion protection

Dura-Kote plating technology

Hose fittings that offer 3x the corrosion protection on carbon steel fittings as compared to competitive hose fittings. Danfoss' Dura-Kote fittings provide up to 1000 hours of corrosion protection. This is a huge step forward in metal fitting corrosion protection. (Only on 1A Series and 4S/6S fittings)



4S/6S fitting

Class 0 Cool-down leakage protection

Dura-Seal technology

This patent-pending innovation from Danfoss eliminates hose assembly cool-down leakage, while extending hose assembly life, reducing equipment down-time. (Only on 4S/6S fittings)

Need

Danfoss has the answer.

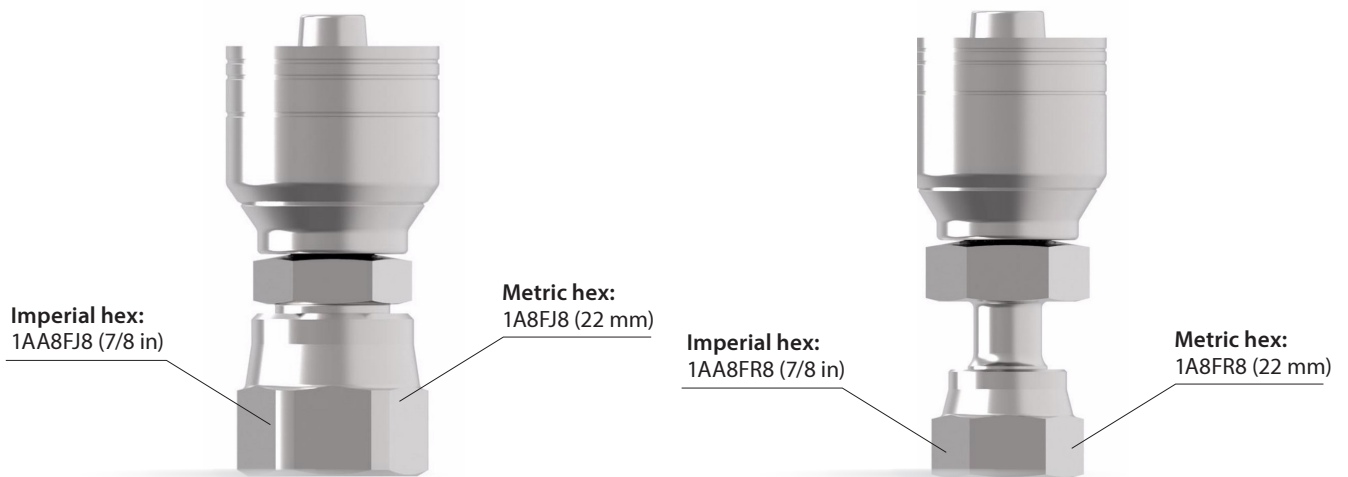

- JIC • ORS • Many imperial FJ and FR fittings have a metric equivalent

*Danfoss metric fittings are not listed in this catalog, please contact customer service for more information.

Crimp specs

Find your crimp specs quickly and easily with the PowerSource Crimp Spec tool. You can create a custom crimp chart from your desktop following these simple steps.

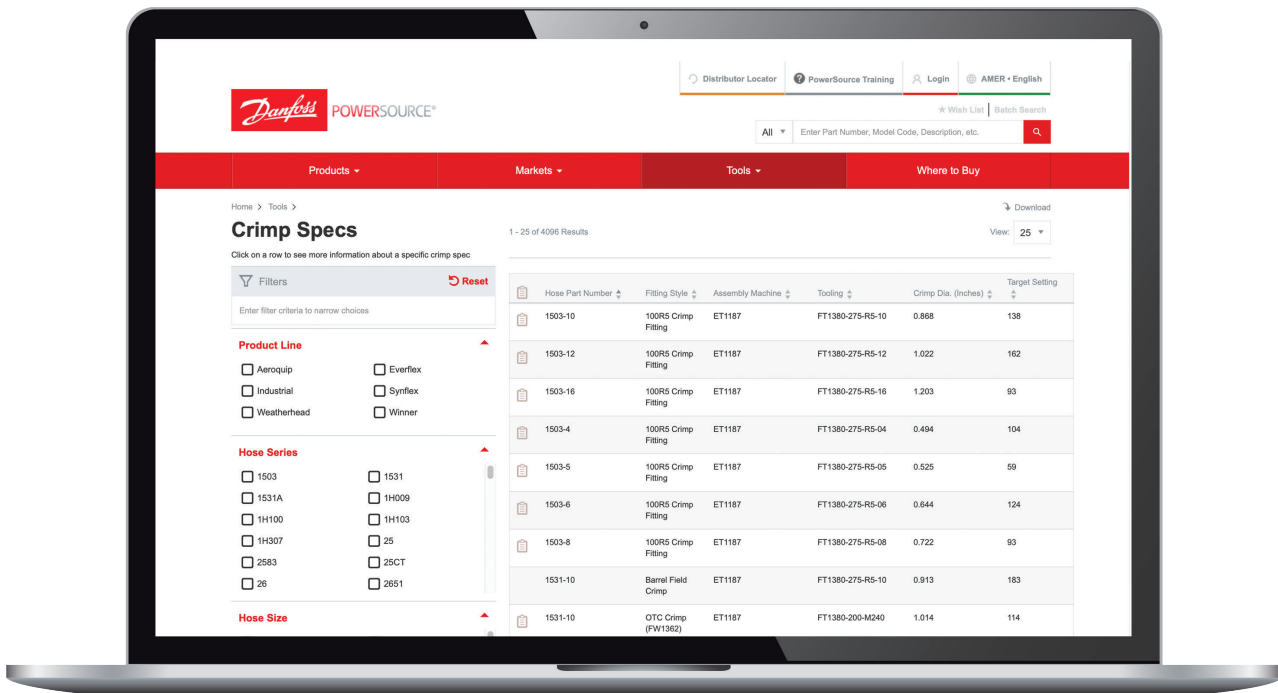

1. Go to PowerSource	2. Enter criteria	3. Download
<p>Visit Crimp Specs at danfoss.com/crimp</p>	<p>Select your crimp spec criteria. This includes Assembly Machine(s), Product Line, Hose Series, Hose Size, and Fitting Style.</p>	<p>Locate the download icon at the top right of the screen and select either the PDF or Excel option to generate your custom chart.</p> <p>*Excel format allows you to perform custom sorting, filter data, remove unneeded fields, and to add custom notes and color coding.</p>

Crimp specs

Danfoss’s mobile crimp spec tool provides a four-step guided selection process for quick access to crimp specs on your mobile device.



Visit PowerSource Crimp specs at [power-source.com](#) on your mobile device

- Find your machine
- Select your hose series
- Select your hose size
- Find your fitting style

You can even bookmark the crimp spec page and add it as an app on the home screen of your mobile device for easy access at any time!

For iOS, open the webpage in Safari, click the boxed arrow icon at the bottom of the screen, and select the plus sign icon “Add to Home Screen.”

For Android, open the webpage, click the three vertical dots on the top right hand corner, and select “Add to Home Screen.”

Danfoss fluid conveyance training

Knowledge is power,

Danfoss' Fluid Conveyance training
(virtual and face-to-face options available)

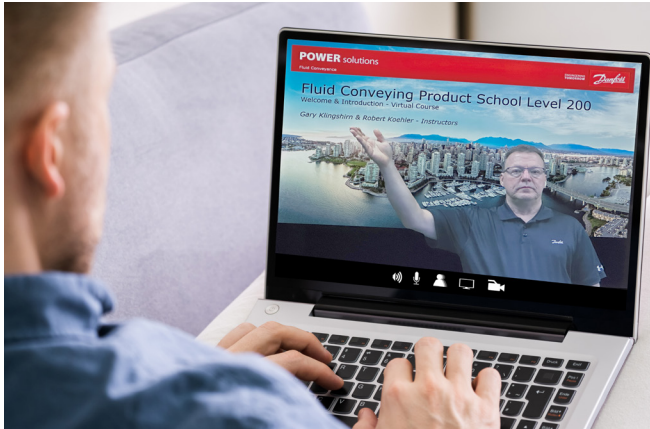

Virtual



Face-to-face

Master Danfoss's core fluid conveyance products and more with the help of our training team! Danfoss offers in depth, formal training courses designed to make you an expert in the field.

Attend Danfoss's 200 Level Fluid Conveying Products School to learn more about general product and application information or Danfoss' 300 and 400 Level Fluid Conveying Products Specialist School for a class focused on more technical information as well as competitive advantage materials.

Check out <https://www.danfoss.com/en-us/service-and-support/training/dps-learning-and-training-solutions/> for specific product courses and dates. If these locations and dates do not work for you, our experts can come to you. Contact hydraulicstraining@Danfoss.com for further details.

Danfoss hydraulics training center

1650 Indian Wood Circle

Maumee, OH 43537

Phone toll free: 1-800-413-8809

Fax: (952) 906-3731

Hydraulicstraining@Danfoss.com

asset tracker

Small label. Big impact.

The Danfoss UniqID asset management solution seamlessly drives new efficiencies into every aspect of the asset lifecycle—from asset tracking, to routinized maintenance alerts, replacement orders and more. Through the use of an intuitive six-digit coding system and cloud-based portal—UniqID asset tracker makes it easy to label, track and replace hose assemblies.



To get started, contact UniqID@Danfoss.com or visit Danfoss.com/UniqID

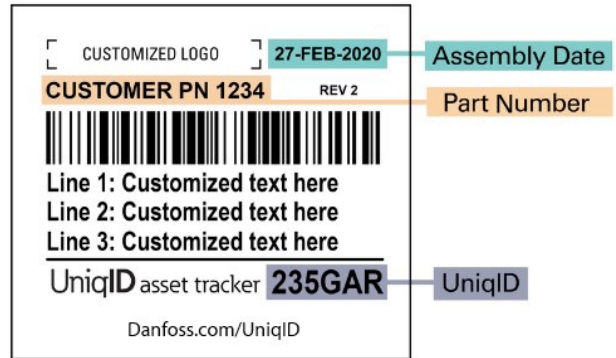

Drive aftermarket sales

Via the UniqID code or label branding

Grow your business

Offer services to set yourself apart from the competition

Prevent attrition

Provide shared asset management information with key accounts



Eliminate paper

With a web-based platform

Proactive inspection and replacement

Cyclical approach to maintenance, increasing sales potential

Improve decision making

With product lifecycle analysis tools

Manage safety certification

With electronic attachment features



Increase uptime

With proactive maintenance capabilities

Reduce downtime

Order replacements without ever bringing in a hose assembly

Reduce fines

By having critical documentation easy to find electronically



Save time

UniqID's bill of material feature takes the guesswork out of hose replacement

Reduce errors

Labels provide critical data at-a-glance

Increase efficiency

Leverage shared attachments; no time wasted searching paper trails

Intelligent layline

Our laylines provide instantly.



***Danfoss MatchMate® fitting system:**

Match fittings to hose with ease.

Braided hose:

1A on the layline should pair with a **1A** on the fitting part number.

One **O** on the layline will match with one ring on fitting designating **one-wire braided hose**.

Double **OO** on the layline will match with two rings on fitting designating **two-wire braided hose**.

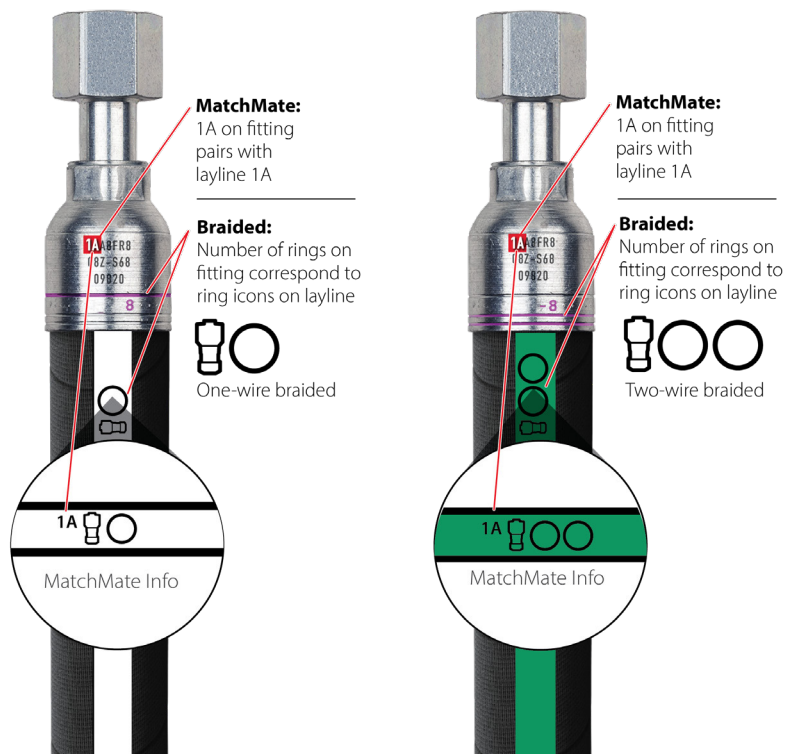

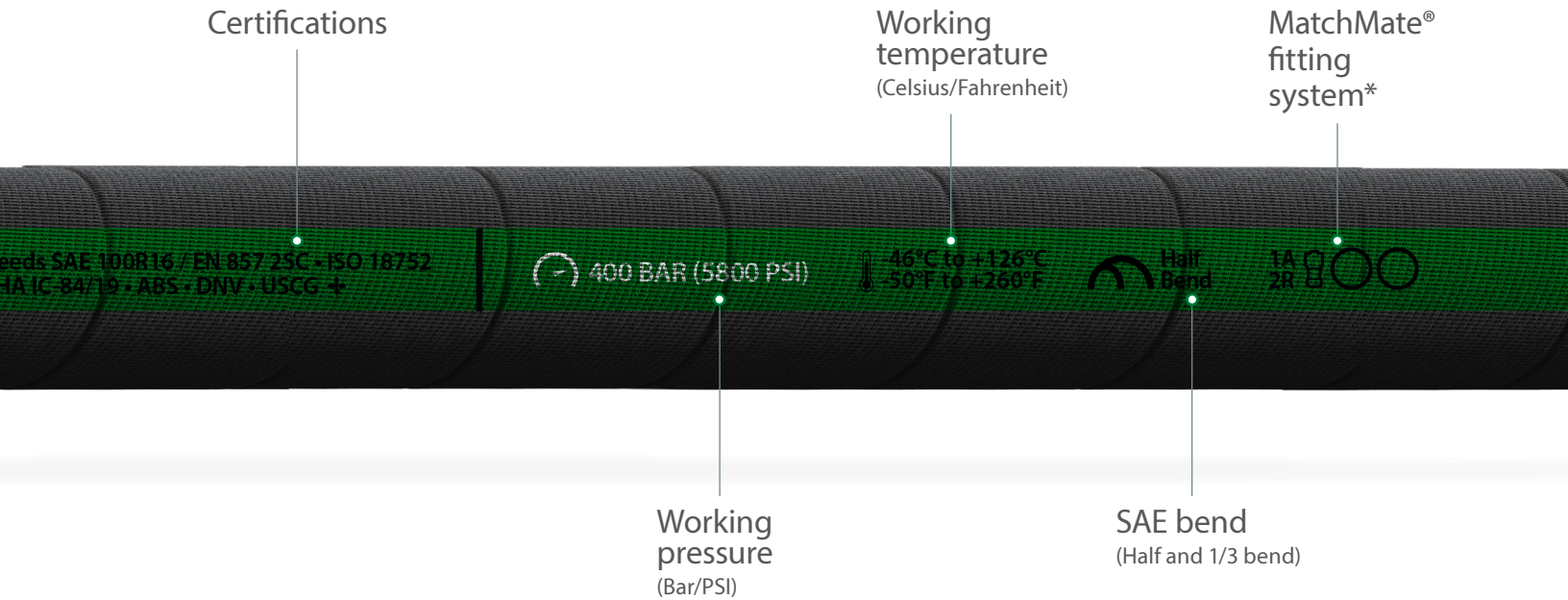

Spiral hose:

A **4S** or **6S** on the layline should pair with a **4S** or **6S** on the fitting part number.

A **4S** on layline should pair with **four rings on fitting** designating **four-wire spiral hose**.

A **6S** on layline will match with **six rings on fitting** designating **six-wire spiral hose**.

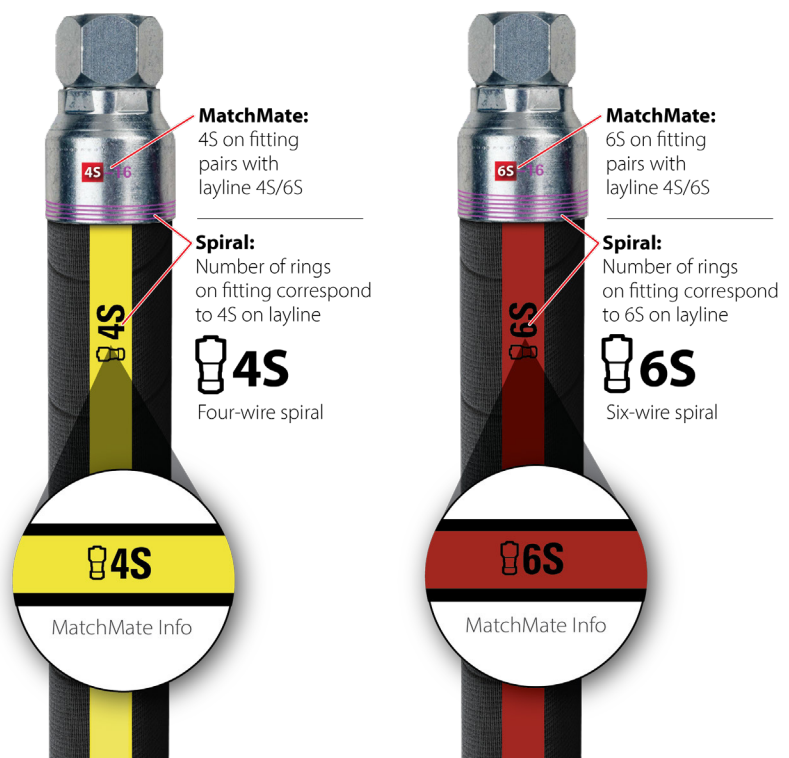

Two-tier product portfolio



From the ordinary to the extreme, Danfoss has a **solution that fits.**



Premium



High-Temp



Low-Temp



Ultra-Abrasion



Suction



Standard

Premium and standard hydraulic hose options:

Premium: Aeroquip by Danfoss

Standard: Winner by Danfoss

At Danfoss, we understand that hydraulic hose and fittings need to match the application, for the ultimate performance and safety.

Because fluid conveyance platforms run the extreme, from low-pressure to high, moderate impulse to intense, from stable familiar environments to unforgiving conditions Danfoss Rubber Hydraulic Hose & Fittings provides options. The option to choose between standard-performance value based hose for less extreme environments and premium hoses developed for specific applications that push to the edge.

We do that for our customers, our partners. For those that put their trust in us. We don't compromise our standards and neither should you. When it comes to safety, technology and performance, we pledge our best, everyday.

Note: All core premium and standard hoses in the catalog are designated with an icon highlighting premium, premium specialty or standard. See chart on following page for more information.



Two-tier product portfolio

The hoses		Operating temperature	Abrasion resistance	Bend radius	Impulse cycles
PREMIUM		Certifications: ABS DNV EN ISO MSHA SAE USCG			
	 Premium	HIGH: 260° F (127° C) LOW: -40° F (-40° C)	Dura-Tuff premium abrasion cover	1/2 Bend (EC881 is 1/3 bend)	Exceed industry standard
HIGH-TEMP		Certifications: ABS DNV EN ISO MSHA SAE USCG			
	 High-Temp	HIGH: 302° F (150° C) LOW: -40° F (40° C)	AQP high temp	Full Bend	Exceed industry standard
LOW-TEMP		Certifications: EN ISO MSHA SAE			
	 Low-Temp	HIGH: 212° F (100° C) LOW: -70° F (-57° C)	Dura-Tuff premium abrasion cover	Full Bend	Exceed industry standard
ULTRA-ABRASION		Certifications: ABS DNV EN ISO MSHA SAE			
	 Abrasion	HIGH: 212° F (100° C) LOW: -40° F (40° C)	Bruiser ultra-abrasion cover	Full Bend (FC735 is 1/2 bend)	Exceed industry standard
SUCTION		Certifications: ABS EN MSHA SAE			
	 Suction	HIGH: 275° F (135° C) LOW: -40° F (40° C)	Standard cover	1/3 Bend	Exceed industry standard

Two-tier product portfolio

The hoses

STANDARD	Certifications: DNV EN ISO MSHA SAE USCG								
 <div style="text-align: center;">  Standard </div>	<table border="1"> <thead> <tr> <th data-bbox="836 342 1003 420">Operating temperature</th> <th data-bbox="1003 342 1170 420">Abrasion resistance</th> <th data-bbox="1170 342 1338 420">Bend radius</th> <th data-bbox="1338 342 1510 420">Impulse cycles</th> </tr> </thead> <tbody> <tr> <td data-bbox="836 420 1003 783"> HIGH: 260° F (127° C) LOW: -40° F (-40° C) </td> <td data-bbox="1003 420 1170 783"> Standard Cover </td> <td data-bbox="1170 420 1338 783"> 1/2 Bend (excluding EC118) </td> <td data-bbox="1338 420 1510 783"> Meet industry standard </td> </tr> </tbody> </table>	Operating temperature	Abrasion resistance	Bend radius	Impulse cycles	HIGH: 260° F (127° C) LOW: -40° F (-40° C)	Standard Cover	1/2 Bend (excluding EC118)	Meet industry standard
Operating temperature	Abrasion resistance	Bend radius	Impulse cycles						
HIGH: 260° F (127° C) LOW: -40° F (-40° C)	Standard Cover	1/2 Bend (excluding EC118)	Meet industry standard						

What are the

Danfoss' core rubber hydraulic portfolio is the heart of our product line. The core two-tier portfolio highlights the very best in technology and safety with hoses that are specifically designed to perform in a diverse range of applications, from the routine to the intense and all levels in-between.

Core two-tier portfolio options



Premium



High-Temp



Low-Temp



Ultra-Abrasion



Suction



Standard

Our core premium hoses for OEM or aftermarket use exceed industry standards for pressure, temperature and abrasion resistance, with options adapted to handle your toughest jobs.

Winner® by Danfoss hoses meet all industry standards for pressure, temperature and abrasion resistance, offering the right product at a competitive price point for OEM markets.

Performance examples:

- Impulse 150%
- 300K cycles
- 121° C
- High frequency flexing
- High pressure impulse

Performance examples:

- Impulse 133%
- 200K cycles
- 100° C
- Normal frequency flexing
- Normal pressure impulse

page diagram

6 Hose construction image



1 Core hose key

✓ Premium

2 Part # and description

GH681

Core premium one wire braided hose

4 Performance qualifications

Meets or exceeds:
SAE 100R17 performance | EN 857 Type 1SC performance | ISO 1436 1SN | ISO 18752

3 Hose part number & hose classification

Premium core hose
GH681

5 Layline

Aeroquip by Danfoss

GH681-6
9.5 mm (0.38 in)
DN10
Dura-Tuff
Exceeds EN 857 1SC Performance / SAE 100R17 - DNV
ISO 1436 1SN - ISO 18752 MSHA IC-84/19 - ABS - USCG
235 BAR (3400 PSI)
-46°C to +126°C
-50°F to +260°F
1A

7 Application and hose information

Typical application:
Petroleum and fire-resistant hydraulic fluids, fuel and lubricating oils, gasoline, water and other industrial fluids

Agency specifications:	MSHA ABS DNV USCG		
Hose construction:	Inner Tube: Nitrile	Reinforcement: One wire braid	Cover: Dura-Tuff Premium Abrasion
Operating temperature:	-46°C to +126°C (-50°F to +260°F)		
Qualified fittings:	1A Series 1R Series (-4, -6, -8, -12, -16)		







8 Part # and hose specs

PART #	SIZE DIMENSIONS				PRESSURE				BEND		WEIGHT	
	Hose I.D.		Hose O.D. (nominal)		Working Pressure	Min. Burst Pressure		Min. Bend Radius		Weight		
	mm	in	mm	in	bar	psi	bar	psi	mm	in	kg/m	lbs/ft
GH681-3	4,8	0.19	10,9	0.42	250,0	3650	1000	14500	45,0	1.77	0,16	0.11
GH681-4	6,4	0.25	12,9	0.51	255,0	3700	1020	14800	50,0	1.97	0,21	0.14
GH681-5	7,9	0.31	14,0	0.55	225,0	3250	900	13000	55,0	2.17	0,22	0.15
GH681-6	9,5	0.38	16,3	0.64	235,0	3400	940	13600	63,0	2.48	0,31	0.21
GH681-8	12,7	0.50	19,9	0.78	221,0	3200	883	12800	90,0	3.54	0,43	0.29
GH681-10	15,9	0.63	22,3	0.88	140,0	2025	559	8100	100,0	3.94	0,44	0.29
GH681-12	19,0	0.75	26,0	1.02	138,0	2000	552	8000	120,0	4.72	0,56	0.37
GH681-16	25,4	1.00	34,0	1.34	103,0	1500	414	6000	150,0	5.91	0,84	0.56
GH681-20	31,8	1.25	41,5	1.63	69,0	1000	276	4000	210,0	8.27	1,01	0.68
GH681-24	38,1	1.50	47,9	1.89	52,0	750	207	3000	250,0	9.84	1,23	0.83
GH681-32	50,8	2.00	64,0	2.52	41,0	600	166	2400	315,0	12.4	2,01	1.32

9 Hose classification

Core |
 Premium |
 Standard |
 Braided |
 Spiral |
 High-Temp |
 Low-Temp |
 Abrasion |
 Suction

1 Core hose key

-  Premium
-  High-Temp
-  Low-Temp
-  Abrasion
-  Suction
-  Standard

2 Part # & description

Hose part number and product description

3 Hose part number and hose classification

Corner key provides easy identification of hose name and premium, standard or core designation

4 Performance qualifications

Hose performance qualifications

- EN
- SAE
- ISO

5 Intelligent layline

Visual representation hose layline

6 Hose construction

Visual representation of hose construction

- One or two wire braid
- Four or six wire spiral
- Other

7 Application & hose info

Application info

- Agency specifications
 - MSHA
 - ABS
 - DNV
 - USCG
- Hose construction
 - Inner tube
 - Reinforcement
 - Cover
- Operating temperature
- Qualified fittings

8 Part # and hose specs

Quickly locate hose part number, sizing, pressure rating, bend radius and weight in an easy to read chart

- Hose Part #
- Size (mm, in):
 - Hose I.D.
 - Hose O.D.
- Pressure (Bar/PSI)
 - Working Pressure
 - Burst Pressure
- Hose bend (mm/in)
- Weight (kg/m | lbs./ft.)

9 Easy hose classification

Easy hose reference identification located at the bottom of all hose part pages

- Core
- Premium
- Standard
- Spiral
- High-temp
- Low-temp
- Abrasion
- Suction

Agency, ISO, EN and SAE descriptions

listings

MSHA US Mine Safety and Health Administration

USCG US Coast Guard

DNV DNV/GL (USA) WC

DIN Deutsche (German) Industrial Norme (Replaced by EN)

EN Committee for European Normalization

ABS American Bureau of Shipping

SAE Society of Automotive Engineers

UL Underwriters Laboratories

ISO International Standards Organization

ISO 18752 performance			
Type	Temperature	Impulse pressure <small>% of max working pressure</small>	Minimum # of cycles
AC	212° F (100° C)	133%	200,000
BC	212° F (100° C)	133%	500,000
CC	250° F (120° C)	133%	500,000
DC	250° F (120° C)	133%	1,000,000

EN hose series	
EN hose series	Description
1ST	One wire braid - standard cover
1SN	One wire braid - thin cover
2ST	Two wire braid - standard cover
2SN	Two wire braid - thin cover
4SP	Four wire spiral
4SH	High pressure four wire spiral
1SC	Compact one wire braid
2SC	Compact two wire braid

SAE 100R hose series	
SAE 100R series	Description
100R1	Steel wire reinforced, rubber covered hydraulic hose (one wire braid)
100R2	High pressure, steel wire reinforced, rubber covered hydraulic hose (two wire braid)
100R3	Double fiber braid (non-metallic), rubber covered hydraulic hose
100R4	Wire inserted hydraulic suction hose
100R5	Single wire braid, textile covered hydraulic hose
100R6	Single fiber braid (non-metallic), rubber covered hydraulic hose
100R7	Thermoplastic hydraulic hose Black - conductive Orange - non-conductive
100R8	High pressure thermoplastic hydraulic hose Black - conductive Orange - non-conductive
100R9	High pressure, four-spiral steel wire reinforced, rubber covered hydraulic hose
100R10	Heavy duty, four-spiral steel wire reinforced, rubber covered hydraulic hose

SAE 100R hose series	
SAE 100R series	Description
100R11	Heavy duty, six-spiral steel wire reinforced, rubber covered hydraulic
100R12	Heavy duty, high impulse, four-spiral wire reinforced, rubber covered hydraulic hose Heavy duty, high impulse, multiple-spiral wire reinforced, rubber covered hydraulic hose
100R13	Heavy duty, high impulse, multiple-spiral wire reinforced, rubber covered hydraulic hose
100R14	Polytetrafluorethylene (PTFE)-lined hydraulic hose, single-stainless steel braid
100R15	Heavy duty, high impulse, multiple-spiral wire reinforced, rubber
100R16	Compact high pressure, one- and two-wire reinforced rubber covered hydraulic hose
100R17	Compact 21 MPa maximum operating pressure, one- and two-steel wire reinforced rubber covered hydraulic hose with smaller bend radius
100R19	Compact 27.5 MPa maximum operating pressure, one- and two-steel wire reinforced rubber covered hydraulic hose with smaller bend radius



Premium



High-Temp



Low-Temp



Ultra-Abrasion

















Suction



Table of contents

The premium hoses

Core hose     

Hose	Page	Hose	Page	Hose	Page
GH681 Core premium one wire braided hose 	39	GH493 Core premium four wire spiral hose 	47	FC639 Premium 3000 PSI constant pressure one & two wire braided hose	54
FC839B Core premium Bruiser ultra-abrasion one & two wire braided hose 	40	FC736 Core premium Bruiser ultra- abrasion four wire spiral hose 	48	GH663 Premium 1/2-bend two wire braided hose	55
GH194 Core premium high temp one wire braided hose 	41	EC525 Core premium high-temp four wire spiral hose 	49	FC849 Premium 4000 PSI constant pressure two wire braided hose	56
GH781 Core premium two wire braided hose 	42	FC500 Core premium X-Flex four & six wire spiral hose 	50	FC849B Premium ultra-abrasion constant pressure two wire braided hose	57
EC881 Core premium Dynamax ultra- performance two wire braided hose 	43	FC273B Core premium Bruiser ultra- abrasion four & six wire spiral hose 	51	FC510 Premium HI-PAC High-Temp two wire braided hose	58
FC735 Core premium Bruiser ultra- abrasion two wire braided hose 	44	EC810 Core premium low-temp four & six wire spiral hose 	52	GH793 Premium two wire braided hose	59
GH195 Core premium high-temp two wire braided hose 	45	EC600 Core premium four & six wire spiral hose 	53	FC611 Premium EPDM one wire braided hose	60
GH120 Premium low-temp two wire braided hose 	46			FC693 Premium EPDM one wire braided hose	61

The **premium** hosesCore hose     

Hose	Page	Hose	Page	Hose	Page
EC502 Premium Llifeseense two wire braided hose	62	FC254 Premium four wire spiral hose	65	FC619 Premium suction hose	72 
FC579 Premium Hi-impulse jack two wire braided hose	63	GH506 Premium four wire spiral hose	66	2661 Premium high-temp suction hose	73
EC230 Premium large bore two wire braided hose	64	FC606 Premium six wire spiral hose	67		
		GH466 Premium six wire spiral hose	68		
		FC636 Premium six wire spiral hose	69		
		EC850 Premium Dynamax ultra-performance four & six wire spiral hose	70		
		EC910 Premium Safeshield Waterblast four wire spiral hose	71		

Ordering information

How to order

Accurate processing and prompt delivery of your order depends on easy identification of your requirements. Please order Aeroquip brand parts using correct part numbers as described in this guide. Inquiries and orders should be directed to your Aeroquip distributor or:

www.Danfoss.com/hydraulics

Part numbers and dash sizes

Dash size designates the nominal size in 16th of an inch. This number immediately follows the part number and is separated from it with a dash.

Dimensions

Dimensions given in this guide for Aeroquip products are approximate and should be used for reference only. Exact dimensional information for a given product is subject to change and varying tolerances; contact Danfoss directly for full current information.

Number system - hydraulic hose

Cut lengths hoses are available only on core hose products. Available cut lengths are 50, 100, and 150 ft. The feet should be expressed in inches:



50 ft = 06000

100 ft = 12000

150 ft = 18000

Last digit is in 1/8 of an inch 00484 = 48 1/2 inches

Most core hoses are offered on reels of 250 or 500 ft lengths:



Up to and including 12 inches: $\pm 1/8''$

Above 12 inches to and including 18 inches: $\pm 3/16''$

Above 18 inches to and including 36 inches: $\pm 1/4''$

Above 36 inches: $\pm 1\%$ of length

WARNING

Hose assemblies

Danfoss manufactures the terminal ends of our hose fittings to the appropriate requirements established by the SAE. Therefore, the performance ratings of these hose fittings meet the SAE requirements. It is possible to order a hose assembly with a fitting terminal end that has a performance rating lower than the hose rating. When ordering hose assemblies, please keep the connecting end performance rating in mind since this may affect overall hose assembly performance. Hose assembly components (hose and fittings) are easily assembled in the field. However, factory assembled field attachable and crimped hose assemblies are available.

For complete information, contact Danfoss.



GH681

Core premium
one wire braided hose

Meets or exceeds:

SAE 100R17 | SAE 100R1 | EN 857 Type 1SC performance | ISO 1436 1SN | ISO 18752

GH681-6
9.5 mm (0.38 in) DN10
Dura-Tuff
Exceeds EN 857 1SC Performance / SAE 100R17 • DNV ISO 1436 1SN • ISO 18752 • MSHA IC-84/19 • ABS • USCG+
↻ 235 BAR (3400 PSI)
-46°C to +126°C
-50°F to +260°F
1/2 BEND
1A 1R

Typical application:

Petroleum and fire-resistant hydraulic fluids, fuel and lubricating oils, gasoline, water and other industrial fluids

Agency specifications:	ABS DNV MSHA USCG		
Hose construction:	Inner tube: Nitrile	Reinforcement: One wire braid	Cover: Dura-Tuff premium abrasion
Operating temperature:	-46°C to +126°C (-50°F to +260°F)		
Qualified fittings:	1A series 1R series (-4, -6, -8, -12, -16)		

PART #	SIZE DIMENSIONS				PRESSURE				BEND		WEIGHT	
	Hose I.D.		Hose O.D. (nominal)		Working Pressure		Min. Burst Pressure		Min. Bend Radius		Weight	
	mm	in	mm	in	bar	psi	bar	psi	mm	in	kg/m	lbs/ft
GH681-3	4,8	0.19	10,9	0.42	250,0	3,650	1,000	14,500	45,0	1.77	0,16	0.11
GH681-4	6,4	0.25	12,9	0.51	255,0	3,700	1,020	14,800	50,0	1.97	0,21	0.14
GH681-5	7,9	0.31	14,0	0.55	225,0	3,250	900	13,000	55,0	2.17	0,22	0.15
GH681-6	9,5	0.38	16,3	0.64	235,0	3,400	940	13,600	63,0	2.48	0,31	0.21
GH681-8	12,7	0.50	19,9	0.78	221,0	3,200	883	12,800	90,0	3.54	0,43	0.29
GH681-10	15,9	0.63	22,3	0.88	140,0	2,025	559	8,100	100,0	3.94	0,44	0.29
GH681-12	19,0	0.75	26,0	1.02	138,0	2,000	552	8,000	120,0	4.72	0,56	0.37
GH681-16	25,4	1.00	34,0	1.34	103,0	1,500	414	6,000	150,0	5.91	0,84	0.56
GH681-20	31,8	1.25	41,5	1.63	69,0	1,000	276	4,000	210,0	8.27	1,01	0.68
GH681-24	38,1	1.50	47,9	1.89	52,0	750	207	3,000	250,0	9.84	1,23	0.83
GH681-32	50,8	2.00	64,0	2.52	41,0	600	166	2,400	315,0	12.4	2,01	1.32

Core | Premium | Standard | Braided | Spiral | High-Temp | Low-Temp | Abrasion | Suction

Premium core hose
FC839B

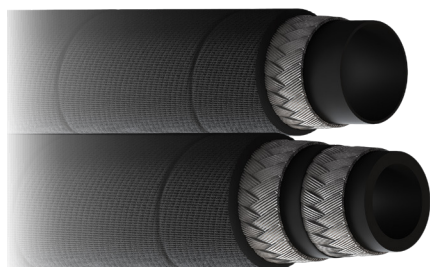

FC839B | Core premium Bruiser ultra-abrasion
one & two wire braided hose

Meets or exceeds: SAE 100R17 | ISO 18752

by Danfoss	9.5 mm (038 in) DN10	SAE 100R17 • ISO 18752 MSHA IC-84/71	-40°C to +100°C -40°F to +212°F	1A
------------	-------------------------	---	------------------------------------	----

Typical application:

High abrasion industrial and hydraulic system applications with petroleum and water-based fluids

Recommended for use on critical applications in construction, forestry, and other off-highway vehicles. Bruiser™ outer cover offers unmatched abrasion, chemical, and environmental protection

Agency specifications:

MSHA

Hose construction:

Inner tube:
Nitrile

Reinforcement:
One wire braid (-04 to -08)
Two wire braid (-10 to -16)

Cover:
Bruiser
ultra-abrasion

Operating temperature:

-40°C to +100°C (-40°F to +212°F)

Qualified fittings:

1A series

PART #	SIZE DIMENSIONS				PRESSURE				BEND		WEIGHT	
	Hose I.D.		Hose O.D. (nominal)		Working Pressure		Min. Burst Pressure		Min. Bend Radius		Weight	
	mm	in	mm	in	bar	psi	bar	psi	mm	in	kg/m	lbs/ft
FC839B-04	6,4	0.25	12,7	0.50	210	3,050	840	12,200	50,0	1.97	0,22	0.15
FC839B-06	9,5	0.38	16,6	0.65	210	3,050	840	12,200	65,0	2.56	0,34	0.23
FC839B-08	12,7	0.50	20,9	0.82	210	3,050	840	12,200	90,0	3.54	0,48	0.32
FC839B-10**	15,9	0.62	24,9	0.98	210	3,050	840	12,200	100,0	3.94	0,71	0.48
FC839B-12**	19,0	0.75	28,5	1.12	210	3,050	840	12,200	120,0	4.72	0,89	0.60
FC839B-16**	25,4	1.00	37,1	1.46	210	3,050	840	12,200	150,0	5.91	1,43	0.96

** two-wire braid hose

Core | Premium | Standard | Braided | Spiral | High-Temp | Low-Temp | Abrasion | Suction



GH194

Core premium high-temp
one wire braided hose

Meets: SAE 100R1 | EN 853 1SN

GH194-6
9.5 mm (0.38 in) DN10
AQP High Temp
Exceeds SAE 100R1 / EN 853 1SN
MSHA IC-84/18 • ABS • DNV
215 BAR (3125 PSI)
-40°C to +150°C
-40°F to +302°F
1A

Typical application:

Petroleum and fire-resistant hydraulic fluids, fuel and lubricating oils, gasoline, water and other industrial fluids

Agency specifications:	ABS DNV MSHA		
Hose construction:	Inner tube: AQP elastomer	Reinforcement: One wire braid	Cover: AQP high-temp
Operating temperature:	-40°C to +150°C (-40°F to +302°F)		
Qualified fittings:	1A series		

PART #	SIZE DIMENSIONS				PRESSURE				BEND		WEIGHT	
	Hose I.D.		Hose O.D. (nominal)		Working Pressure		Min. Burst Pressure		Min. Bend Radius		Weight	
	mm	in	mm	in	bar	psi	bar	psi	mm	in	kg/m	lbs/ft
GH194-4	6,4	0.25	13,5	0.53	225	3,250	900	13,000	100,0	3.94	0,25	0.17
GH194-6	9,5	0.38	17,3	0.68	215	3,125	860	12,500	125,0	4.92	0,37	0.25
GH194-8	12,7	0.50	20,4	0.80	175	2,550	700	10,200	180,0	7.09	0,45	0.30
GH194-10	15,9	0.62	23,8	0.94	140	2,050	560	8,200	205,0	8.07	0,54	0.36
GH194-12	19,0	0.75	27,4	1.08	125	1,800	500	7,200	240,0	9.45	0,69	0.46
GH194-16	25,4	1.00	36,2	1.42	90	1,300	360	5,200	300,0	11.81	0,98	0.66
GH194-20	31,8	1.25	43,9	1.73	65	950	260	3,800	420,0	16.54	1,26	0.85
GH194-24	38,1	1.50	50,6	1.99	50	725	200	2,900	500,0	19.69	1,58	1.06
GH194-32	50,8	2.00	59,2	2.33	40	580	160	2,320	630,0	24.80	2,04	1.37

Premium core hose
GH781



Premium



GH781

Core premium
two wire braided hose

Meets or exceeds: SAE 100R16 | EN 857 2SC | ISO 18752 | ISO 11237

GH781-6 9.5 mm (0.38 in) DN10 **Dura-Tuff** Exceeds SAE 100R16 / EN 857 2SC - ISO 18752 MSHA IC-84/19 - ABS - DNV - USCG + **400 BAR (5800 PSI)** -46°C to +126°C (-50°F to +260°F)

Typical application:

Hydraulic systems service with petroleum and water based fluids, for general use.

Agency specifications:	ABS DNV MSHA USCG		
Hose construction:	Inner tube: Nitrile	Reinforcement: Two wire braid	Cover: Dura-Tuff premium abrasion
Operating temperature:	-46°C to +126°C (-50°F to +260°F)		
Qualified fittings:	1A series 2R series (-4, -6, -8, -12 & -16)		

PART #	SIZE DIMENSIONS				PRESSURE				BEND		WEIGHT	
	Hose I.D.		Hose O.D. (nominal)		Working Pressure		Min. Burst Pressure		Min. Bend Radius		Weight	
	mm	in	mm	in	bar	psi	bar	psi	mm	in	kg/m	lbs/ft
GH781-4	6,4	0.25	13,9	0.55	448	6,500	1,792	26,000	50,0	1.96	0,33	0.22
GH781-6	9,5	0.38	17,4	0.69	400	5,800	1,600	23,200	65,0	2.55	0,43	0.29
GH781-8	12,7	0.50	20,9	0.82	350	5,000	1,400	20,000	90,0	3.54	0,58	0.39
GH781-10	15,9	0.62	24,0	0.94	280	4,000	1,120	16,000	100,0	3.94	0,65	0.44
GH781-12	19,0	0.75	27,9	1.10	241	3,500	964	14,000	120,0	4.72	0,79	0.53
GH781-16	25,4	1.00	35,9	1.41	210	3,000	840	12,000	150,0	5.90	1,07	0.72
GH781-20	31,8	1.25	43,4	1.71	172	2,500	688	10,000	210,0	8.26	1,62	1.09
GH781-24	38,1	1.50	51,5	2.03	140	2,000	560	8,000	250,0	9.84	2,08	1.40
GH781-32	50,8	2.00	63,9	2.52	110	1,600	440	6,400	315,0	12.40	2,83	1.90

Core | Premium | Standard | Braided | Spiral | High-Temp | Low-Temp | Abrasion | Suction



EC881

Core premium Dynamax ultra-performance two wire braided hose

Exceeds: SAE 100R16 | SAE 100R19 | EN 857 2SC | ISO 18752

EC881-6 9.5 MM (0.38 IN) DN10
 Dura-Tuff Dynamax
Exceeds SAE 100R16 / 100R19 / EN 857 2SC ISO 18752 • ABS • DNV • MSHA IC 84/56
↻ 400 BAR (5800 PSI)
-46°C to +126°C (-50°F to +260°F)
 1/3 Bend
1A

Typical application:

Hydraulic systems with petroleum and water-based fluids, for general industrial service.

This Dynamax ultra-performance hose with the Danfoss Dura-Pulse inner tube combines the lightweight flexibility of a two-wire braided hose with the pressure and performance of spiral 100R12 hoses (-16 and smaller).

Agency specifications: ABS | DNV | MSHA

Hose construction:	Inner tube: Dura-Pulse patented tube	Reinforcement: Two wire braid	Cover: Dura-Tuff premium abrasion
---------------------------	--	---	---

Operating temperature:
-46°C to +126°C (-50°F to +260°F)
-46° C to +70° C (-50 to +158° F) for water based hyd. fluids
0° C to +70° C (+32° F to 158° F) for water

Qualified fittings: 1A series

PART #	SIZE DIMENSIONS				PRESSURE				BEND		WEIGHT	
	Hose I.D.		Hose O.D. (nominal)		Working Pressure		Min. Burst pressure		Min. Bend Radius		Weight	
	mm	in	mm	in	bar	psi	bar	psi	mm	in	kg/m	lbs/ft
EC881-4	6.4	0.25	13.6	0.54	450	6,525	1,800	26,100	33,0	1.30	0.32	0.22
EC881-6	9.5	0.38	17.3	0.68	400	5,800	1,600	23,200	42,0	1.65	0.42	0.28
EC881-8	12.7	0.50	20.9	0.82	360	5,220	1,440	20,880	60,0	2.36	0.58	0.39
EC881-10	15.9	0.62	24.0	0.94	350	5,075	1,400	20,300	68,0	2.68	0.75	0.50
EC881-12	19.0	0.75	27.9	1.10	330	4,785	1,320	19,140	80,0	3.15	1.03	0.69
EC881-16	25.4	1.00	34.6	1.36	280	4,060	1,120	16,240	150,0	5.91	1.47	0.99
EC881-20	31.8	1.25	43.4	1.71	172	2,500	688	9,980	210,0	8.27	1.75	1.18
EC881-24	38.1	1.50	51.8	2.04	138	2,000	552	8,000	250,0	9.84	1.91	1.28

Premium core hose
FC735

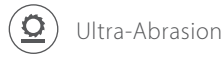

FC735

Core premium Bruiser ultra-abrasion
two wire braided hose

Exceeds: SAE 100R16 | EN 857 2SC | ISO 18752 | ISO 11237



FC735-06
9.5 mm (0.38 in) DN10
Bruiser
Exceeds SAE 100R16 / EN 857 2SC ISO 18752 - MSHA 1C-84/71 - ABS - DNV
400 BAR (5800 PSI)
-40°C to +126°C (-40°F to +260°F)
Half Bend
1A

Typical application:

Hydraulic systems service with petroleum and water based fluids, for general use.

Agency specifications:	ABS MSHA DNV		
Hose construction:	Inner tube: Nitrile	Reinforcement: Two wire braid	Cover: Bruiser ultra-abrasion
Operating temperature:	-40°C to +126°C (-40°F to +260°F)		
Qualified fittings:	1A series		

PART #	SIZE DIMENSIONS				PRESSURE				BEND		WEIGHT	
	Hose I.D.		Hose O.D. (nominal)		Working Pressure		Min. Burst pressure		Min. Bend Radius		Weight	
	mm	in	mm	in	bar	psi	bar	psi	mm	in	kg/m	lbs/ft
FC735-04	6,4	0.25	14,1	0.55	448	6,500	1,792	26,025	50,0	1.97	0,31	0.21
FC735-06	9,5	0.38	17,4	0.69	400	5,800	1,600	23,200	65,0	2.56	0,42	0.28
FC735-08	12,7	0.50	20,8	0.82	345	5,000	1,380	20,000	90,0	3.54	0,49	0.33
FC735-10	15,9	0.62	24,9	0.98	276	4,000	1,104	16,060	100,0	3.94	0,71	0.48
FC735-12	19,0	0.75	28,4	1.12	241	3,500	964	13,960	120,0	4.72	0,83	0.56
FC735-16	25,4	1.00	35,7	1.41	207	3,000	828	12,000	150,0	5.91	1,19	0.80
FC735-20	31,8	1.25	43,3	1.70	172	2,500	688	9,965	210,0	8.27	1,52	1.02

Core | Premium | Standard | Braided | Spiral | High-Temp | Low-Temp | Abrasion | Suction



GH195

Core premium AQP high-temp
two wire braided hose

Meets: SAE 100R2 | EN 853 2SN | ISO 1436 2SN

Aeroquip by Danfoss **GH195-6** 9.5 mm (0.38 in) DN10 **AQP High Temp** Exceeds SAE 100R2 / EN 853 2SN + ISO 1436-1 2SN MSHA IIC-84/18 + ABS + DNV + USCG + **345 BAR (5000 PSI)** -40°C to +150°C / -40°F to +302°F 1A

Typical application:

Petroleum and fire resistant hydraulic fluids, fuel, and lubricating systems

Agency specifications:	ABS DNV MSHA USCG		
Hose construction:	Inner tube: AQP elastomer	Reinforcement: Two wire braid	Cover: AQP high-temp
Operating temperature:	-40°C to +150°C (-40°F to +302 °F)		
Qualified fittings:	1A series		

PART #	SIZE DIMENSIONS				PRESSURE				BEND		WEIGHT	
	Hose I.D.		Hose O.D. (nominal)		Working Pressure		Min. Burst Pressure		Min. Bend Radius		Weight	
	mm	in	mm	in	bar	psi	bar	psi	mm	in	kg/m	lbs/ft
GH195-4	6,4	0.25	15,1	0.59	400,0	5,800	1,600	23,200	102,0	4.02	0,40	0.27
GH195-6	9.5	0.38	19,2	0.75	345,0	5,000	1,380	20,000	127,0	5.00	0,58	0.39
GH195-8	12,7	0.50	22,1	0.87	293,0	4,250	1,172	17,000	178,0	7.01	0,68	0.46
GH195-10	15.9	0.62	25,5	1.00	250,0	3,650	1,000	14,600	203,0	7.99	0,80	0.54
GH195-12	19,0	0.75	29,5	1.16	215,0	3,125	860	12,500	241,0	9.49	1,00	0.67
GH195-16	25,4	1.00	37,8	1.49	175,0	2,550	700	10,200	305,0	12.01	1,44	0.97
GH195-20	31,8	1.25	48,5	1.91	155,0	2,250	620	9,000	419,0	16.50	2,38	1.60
GH195-24	38,1	1.50	55,1	2.17	125,0	1,800	500	7,250	508,0	20.00	2,59	1.74
GH195-32	50,8	2.00	67,8	2.67	105,0	1,525	420	6,100	635,0	25.00	3,38	2.27

Premium core hose
GH120



Low-Temp

GH120

Core premium low-temp
two wire braided hose

Exceeds: SAE 100R16 | EN 857 2SC | ISO 11237

	GH120-6	9.5 mm (0.38 in) DN10	Dura-Tuff Low-Temp	Exceeds SAE 100R16 / EN 857 2SC ISO 11237-1	345 BAR (5000 PSI)	-57°C to +100°C -70°F to +212°F	1A
--	----------------	--------------------------	-----------------------	--	--------------------	------------------------------------	----

Typical application:

Low temperature flexing and hydraulic system service with petroleum and water-based fluids

For use in frigid environments on construction equipment and other mobile applications

Agency specifications:	MSHA		
Hose construction:	Inner tube: Proprietary low-temp	Reinforcement: Two wire braid	Cover: Dura-Tuff premium abrasion
Operating temperature:	-57° C to +100° C (-70° F to +212° F)		
Qualified fittings:	1A series		

PART #	SIZE DIMENSIONS				PRESSURE				BEND		WEIGHT	
	Hose I.D.		Hose O.D. (nominal)		Working Pressure		Min. Burst Pressure		Min. Bend Radius		Weight	
	mm	in	mm	in	bar	psi	bar	psi	mm	in	kg/m	lbs/ft
GH120-4	6,4	0.25	13,8	0.54	414,0	6,000	1,656	24,025	51,0	2.00	0,30	0.20
GH120-6	9,5	0.38	17,4	0.68	345,0	5,000	1,380	20,025	64,0	2.50	0,40	0.27
GH120-8	12,7	0.50	20,8	0.82	310,0	4,500	1,240	18,000	89,0	3.50	0,58	0.39
GH120-10	15,9	0.62	24,9	0.98	276,0	4,000	1,104	16,000	102,0	4.00	0,74	0.50
GH120-12	19,0	0.75	28,4	1.12	241,0	3,500	964	14,000	121,0	4.75	0,92	0.62
GH120-16	25,4	1.00	35,7	1.41	193,0	2,800	772	11,200	152,0	6.00	1,22	0.82
GH120-20	31,8	1.25	43,3	1.71	159,0	2,300	636	9,225	210,0	8.25	1,59	1.07
GH120-24	38,1	1.50	51,5	2.03	138,0	2,000	552	8,000	254,0	10.00	2,11	1.42
GH120-32	50,8	2.00	63,9	2.51	103,0	1,500	412	6,000	318,0	12.50	2,80	1.88

Core | Premium | Standard | Braided | Spiral | High-Temp | **Low-Temp** | Abrasion | Suction



Premium

GH493

Core premium
four wire spiral hose

Exceeds: SAE 100R12 | EN 856 R12 | EN 856 4SP (-8 to -16) | ISO 18752 | ISO 3862 R12

by Danfoss **GH493-6** 9.5 mm (0.38 in) DN10 Dura-Tuff Exceeds SAE 100R12 / EN 856 R12 MSHA IC-84/19 - ABS - DNV - USCG+ 448 BAR (6500 PSI) -40°C to +126°C -40°F to +260°F Half Bend 4S

Typical application:

For very high pressure hydraulic lines subjected to pressure surges and flexing

Typical applications include construction, mining, farming and high performance industrial equipment

Agency specifications: ABS | DNV | MSHA | USCG

Hose construction:	Inner tube:	Reinforcement:	Cover:
	Nitrile	Four wire spiral	Dura-Tuff premium abrasion

Operating temperature: -40°C to +126°C (-40°F to +260°F)

Qualified fittings: 4S series

PART #	SIZE DIMENSIONS				PRESSURE				BEND		WEIGHT	
	Hose I.D.		Hose O.D. (nominal)		Working Pressure		Min. Burst Pressure		Min. Bend Radius		Weight	
	mm	in	mm	in	bar	psi	bar	psi	mm	in	kg/m	lbs/ft
GH493-6	9,5	0.38	20,2	0.80	448,0	6,500	1,792	26,000	62,5	2.46	0,71	0.47
GH493-8	12,7	0.50	23,6	0.93	415,0	6,000	1,660	24,000	90,0	3.54	0,88	0.59
GH493-10	15,9	0.62	27,4	1.08	415,0	6,000	1,660	24,000	100,0	3.94	1,04	0.70
GH493-12	19,0	0.75	30,7	1.21	380,0	5,500	1,520	22,000	120,0	4.72	1,34	0.90
GH493-16	25,4	1.00	37,9	1.49	350,0	5,100	1,400	20,400	150,0	5.91	1,79	1.20
GH493-20	31,8	1.25	46,6	1.83	310,0	4,500	1,240	18,000	210,0	8.27	2,23	1.50
GH493-24	38,1	1.50	53,9	2.12	275,0	4,000	1,100	16,000	250,0	9.84	3,03	2.03
GH493-32	50,8	2.00	66,8	2.63	275,0	4,000	1,100	16,000	320,0	12.60	4,38	2.94

Core | Premium | Standard | Braided | **Spiral** | High-Temp | Low-Temp | Abrasion | Suction

Premium core hose
FC736



FC736 | Core premium Bruiser ultra-abrasion four wire spiral hose

Exceeds: SAE 100R12 | EN 856 R12 | ISO 18752

by Danfoss	9.5 mm (0.38 in) DN10	Exceeds SAE 100R12 / EN 856 R12 ISO 18752 - MSHA IC-84/71 - DNV	-40°C to +121°C -40°F to +250°F	4S
------------	--------------------------	--	------------------------------------	----

Typical application:

High abrasion industrial and hydraulic system applications with petroleum and water-based fluids

Recommended for critical applications in construction, forestry, and other off-highway vehicles

Bruiser ultra-abrasion outer cover offers unmatched abrasion, chemical and environmental protection

Agency specifications:

ABS | DNV | MSHA

Hose construction:	Inner tube: Nitrile	Reinforcement: Four wire spiral	Cover: Bruiser ultra-abrasion
---------------------------	-------------------------------	---	---

Operating temperature: -40°C to +121°C (-40°F to +250°F)

Qualified fittings: 4S series

PART	SIZE DIMENSIONS				PRESSURE				BEND		WEIGHT	
	Hose I.D.		Hose O.D. (nominal)		Working Pressure		Min. Burst Pressure		Min. Bend Radius		Weight	
#	mm	in	mm	in	bar	psi	bar	psi	mm	in	kg/m	lbs/ft
FC 736-06	9,5	0.38	20,2	0.80	380	5,500	1,520	22,000	125,0	4.92	0,71	0.48
FC736-08	12,7	0.50	23,6	0.93	345	5,000	1,380	20,000	180,0	7.09	0,83	0.56
FC736-10	15,9	0.62	27,4	1.08	345	5,000	1,380	20,000	200,0	7.87	0,98	0.66
FC736-12	19,0	0.75	30,7	1.21	280	4,050	1,120	16,200	240,0	9.45	1,32	0.89
FC736-16	25,4	1.00	37,9	1.49	280	4,050	1,120	16,200	300,0	11.81	1,75	1.18
FC736-20	31,8	1.25	46,6	1.83	210	3,050	840	12,200	420,0	16.54	2,36	1.59
FC736-24	38,1	1.50	53,9	2.12	175	2,550	700	10,200	500,0	19.68	3,00	2.01
FC736-32	50,8	2.00	66,8	2.63	175	2,550	700	10,200	640,0	25.2	4,37	2.94



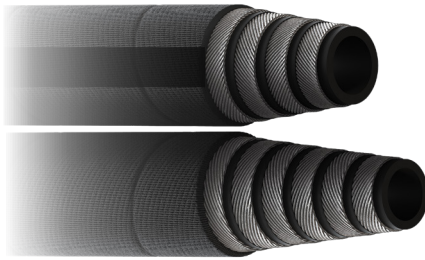

Core | Premium | Standard | Braided | **Spiral** | High-Temp | Low-Temp | **Abrasion** | Suction



 High-Temp

EC525

Core premium AQP™ high-temp
four & six wire spiral hose

EC525-12
19 mm (0.75 in) DN19
AQP High Temp
MSHA IC-84/18
 345 BAR (5000 PSI)
 -40°C to +149°C
-40°F to +300°F
 4S

Typical application:

Hydraulic system service with petroleum, fire-resistant, and water-based fluids, fuel, and lubricating systems

Agency specifications:	DNV MSHA		
Hose construction:	Inner tube: AQP Elastomer	Reinforcement: Four wire spiral (-12 to -24) Six wire spiral (-32)	Cover: AQP high-temp
Operating temperature:	Typical fluids: -40°C To +149°C (-40°F To +300°F) Phosphate-ester base fluids: -40°C To +82°C (-40°F To +180°F)		
Qualified fittings:	4S series		

PART #	SIZE DIMENSIONS				PRESSURE				BEND		WEIGHT	
	Hose I.D.		Hose O.D. (nominal)		Working Pressure		Min. Burst Pressure		Min. Bend Radius		Weight	
	mm	in	mm	in	bar	psi	bar	psi	mm	in	kg/m	lbs/ft
EC525-12	19,0	0.75	30,7	1.21	345,0	5,000	1,380	20,000	241,3	9.50	1,28	0.86
EC525-16	25,4	1.00	37,9	1.49	345,0	5,000	1,380	20,000	304,8	12.00	1,73	1.16
EC525-20	31,8	1.25	46,6	1.84	240,0	3,500	960	14,000	419,1	16.50	2,31	1.55
EC525-24	38,1	1.50	53,9	2.12	240,0	3,500	960	14,000	508,0	20.00	2,96	1.99
EC525-32	50,8	2.00	67,3	2.65	225,0	3,250	900	13,000	635,0	25.00	4,42	2.97

Premium core hose
FC500

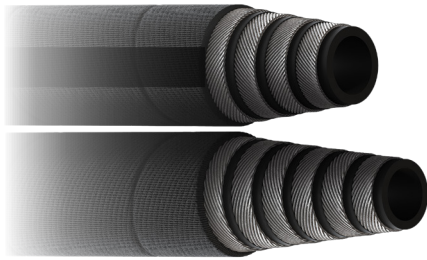

FC500 | Core premium X-Flex
four & six wire spiral hose

Exceeds: SAE 100R13 | EN 856 R13 | ISO 3862 | ISO 18752

FC500-16 25.4 mm (1.00 in) DN25 **Dura-Tuff X-Flex** Exceeds SAE 100R13 / EN 856 R13 / ISO 3862 R13 MSHA IC-84/19 • DNV • USCG+ **350 BAR (5100 PSI)** -40°C to +127°C / -40°F to +260°F **4S**

Typical application:

Ultra high pressure applications compatible with petroleum and water-based fluids

Agency specifications:	DNV MSHA USCG		
Hose construction:	Inner tube: Nitrile	Reinforcement: Four wire spiral (-12 to -24) Six wire spiral (-32)	Cover: Dura-Tuff premium abrasion
Operating temperature:	-40°C to +127°C (-40°F to +260°F)		
Qualified fittings:	4S series (-12 to -24) 6S series (-32)		

PART #	SIZE DIMENSIONS				PRESSURE				BEND		WEIGHT	
	Hose I.D.		Hose O.D. (nominal)		Working Pressure		Min. Burst Pressure		Min. Bend Radius		Weight	
	mm	in	mm	in	bar	psi	bar	psi	mm	in	kg/m	lbs/ft
FC500-12	19,0	0.75	31,0	1.22	350,0	5,100	1,400	20,400	121,0	4.75	1,28	0.86
FC500-16	25,4	1.00	38,4	1.51	350,0	5,100	1,400	20,400	152,0	6.00	1,85	1.24
FC500-20	31,8	1.25	45,5	1.79	350,0	5,100	1,400	20,400	210,0	8.25	2,50	1.68
FC500-24	38,1	1.50	53,5	2.11	350,0	5,100	1,400	20,400	254,0	10.00	3,38	2.27
FC500-32**	50,8	2.00	71,8	2.83	350,0	5,100	1,400	20,400	476,0	18.75	6,07	4.08

** Six wire spiral

Core | Premium | Standard | Braided | **Spiral** | High-Temp | Low-Temp | Abrasion | Suction

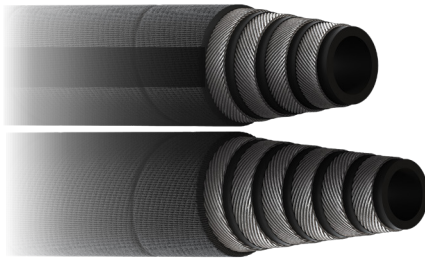

FC273B

Core premium Bruiser ultra-abrasion
four & six wire spiral hose

Exceeds: SAE 100R13 | EN 856 R13 | ISO 3862 | ISO 18752

Aeroquip by Danfoss	FC273B-12	19.0 mm (0.75 in) DN19	Bruiser	Exceeds SAE 100R13 / EN 856 R13 ISO 3862 • MSHA IC-84/71	350 BAR (5100 PSI)	-40°C to +121°C -40°F to +250°F	1E 4S
---------------------	------------------	---------------------------	----------------	---	---------------------------	------------------------------------	------------------

Typical application:

High abrasion industrial and hydraulic system applications with petroleum and water-based fluids

Recommended for use on critical applications in construction, forestry, and other off-highway vehicles

Bruiser ultra-abrasion outer cover offers unmatched abrasion resistance

Agency specifications:	MSHA		
Hose construction:	Inner tube: Nitrile	Reinforcement: Four wire spiral (-12 to -16) Six wire spiral (-20 to -32)	Cover: Bruiser ultra-abrasion
Operating temperature:	-40°C to +121°C (-40°F to +250°F)		
Qualified fittings:	4S series (-12 to -16) 6S series (-20 to -32)		

PART #	SIZE DIMENSIONS				PRESSURE				BEND		WEIGHT	
	Hose I.D.		Hose O.D. (nominal)		Working Pressure		Min. Burst Pressure		Min. Bend Radius		Weight	
	mm	in	mm	in	bar	psi	bar	psi	mm	in	kg/m	lbs/ft
FC273B-12	19,0	0.75	32,1	1.26	350	5,100	1,400	20,400	241,0	9.50	1,55	1.04
FC273B-16	25,4	1.00	38,7	1.53	350	5,100	1,400	20,400	305,0	12.00	1,95	1.31
FC273B-20**	31,8	1.25	50,3	1.98	350	5,100	1,400	20,400	419,0	16.50	3,63	2.44
FC273B-24**	38,1	1.50	57,7	2.27	350	5,100	1,400	20,400	508,0	20.00	4,78	3.21
FC273B-32**	50,8	2.00	71,8	2.83	350	5,100	1,400	20,400	635,0	25.00	7,05	4.74

** Six wire spiral

Premium core hose
EC810

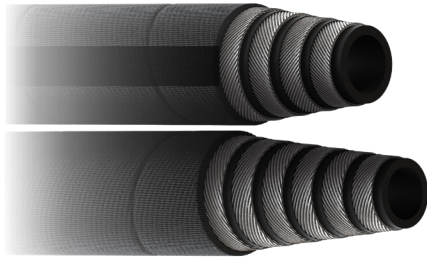

 Low-Temp

EC810

Core premium low-temp
four & six wire spiral hose

Meets or exceeds: SAE 100R15 | EN 856 4SH Performance

 **EC810-12** 19.0 mm (0.75 in) DN19 **Low-Temp** **MSHA IC-84/19** **420 BAR (6100 PSI)** -57°C to +100°C
-70°F to +212°F **4S**

Typical application:

Fluids for low temperature applications.
Hydraulic systems with petroleum-based fluids

Agency specifications:	MSHA		
Hose construction:	Inner tube: Nitrile	Reinforcement: Four wire spiral (-12 to -16) Six wire spiral (-20 to -32)	Cover: Nitrile
Operating temperature:	-57°C to +100°C (-70°F to +212°F)		
Qualified fittings:	4S series (-12 to -16) 6S series (-20 to -32)		

PART #	SIZE DIMENSIONS				PRESSURE				BEND		WEIGHT	
	Hose I.D.		Hose O.D. (nominal)		Working Pressure		Min. Burst Pressure		Min. Bend Radius		Weight	
	mm	in	mm	in	bar	psi	bar	psi	mm	in	kg/m	lbs/ft
EC810-12	19,0	0.75	32,2	1.27	420	6,100	1,680	24,360	280,0	11.02	1,61	1.08
EC810-16	25,4	1.00	39,0	1.54	420	6,100	1,680	24,360	340,0	13.39	2,02	1.36
EC810-20**	31,8	1.25	49,4	1.94	420	6,100	1,680	24,360	420,0	16.54	3,55	2.39
EC810-24**	38,1	1.50	57,3	2.26	420	6,100	1,680	24,360	510,0	20.08	4,74	3.19
EC810-32**	50,8	2.00	71,7	2.82	350	5,100	1,400	20,400	630,0	24.80	6,70	4.50

**Six wire spiral

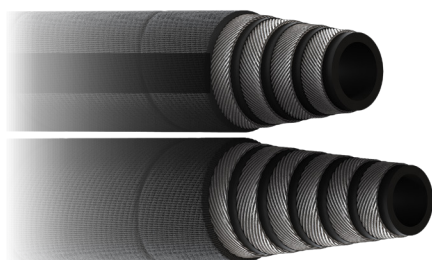

EC600

Core premium X-Flex
four & six wire spiral hose

Meets or exceeds: SAE 100R15 | EN 856 4SH | EN 856 R13 | ISO 18752

by Danfoss EC600-12	19.0 MM (0.75 IN) DN19	Dura-Tuff X-Flex	Exceeds SAE 100R15 • ISO 18752 MSHA IC-84/19 • ABS • DNV • USCG+	420 BAR (6100 PSI)	-40°C to +127°C -40°F to +260°F	Half Bend	4S 1W
----------------------------	---------------------------	---------------------	---	--------------------	------------------------------------	--------------	----------

Typical application:

High pressure hydraulic circuits on mobile construction equipment, mining equipment, and industrial applications for pressures up to 420 bar.

Agency specifications:	ABS DNV MSHA USCG		
Hose construction:	Inner tube: Dura-Pulse patented inner tube	Reinforcement: Four wire spiral (-12 to -16) Six wire spiral (-20 to -32)	Cover: Dura-Tuff premium abrasion
Operating temperature:	-40°C to +127°C (-40°F to +260°F)		
Qualified fittings:	4S series (-12 to -16) 6S series (-20 to -32) 1W series		

PART #	SIZE DIMENSIONS				PRESSURE				BEND		WEIGHT	
	Hose I.D.		Hose O.D. (nominal)		Working Pressure		Min. Burst Pressure		Min. Bend Radius		Weight	
	mm	in	mm	in	bar	psi	bar	psi	mm	in	kg/m	lbs/ft
EC600-12	19.0	0.75	32.2	1.27	420	6,100	1,680	24,400	135,0	5.31	1.52	1.01
EC600-16	25.4	1.00	38.6	1.52	420	6,100	1,680	24,400	165,0	6.5	2.04	1.36
EC600-20**	31.8	1.25	49.7	1.96	420	6,100	1,680	24,400	225,0	8.86	3.89	2.61
EC600-24**	38.1	1.50	57.5	2.26	420	6,100	1,680	24,400	265,0	10.43	4.83	3.24
EC600-32**	50.8	2.00	71.0	2.79	420	6,100	1,680	24,400	375,0	14.76	7.1	4.77

**Six wire spiral

Premium hose
FC639

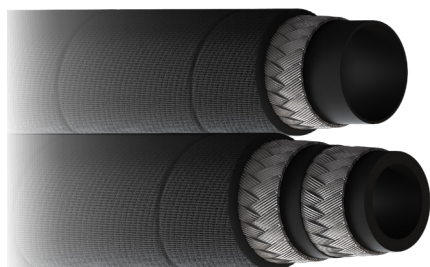

FC639

Premium 3050 PSI constant pressure
one & two wire braided hose

Exceeds: SAE 100R17 | ISO 18752

 by Danfoss **FC639-06** 9.5 mm (0.38 in) DN10 **Dura-Tuff** SAE 100R17 - ISO 18752 MSHA IC-84/19 **210 BAR (3050 PSI)** -40°C to +127°C -40°F to +260°F 1A 

Typical application:

General industrial and hydraulic system service with petroleum and water-based fluids. Recommended for high-pressure oil lines used on construction equipment and other off-highway applications

Agency specifications:	MSHA		
Hose construction:	Inner tube: Nitrile	Reinforcement: One wire braid (-04 to -08) Two wire braid (-10 to -16)	Cover: Dura-Tuff premium abrasion
Operating temperature:	-40°C to +127°C (-40°F to +260°F)		
Qualified fittings:	1A series		

PART #	SIZE DIMENSIONS				PRESSURE				BEND		WEIGHT	
	Hose I.D.		Hose O.D. (nominal)		Working Pressure		Min. Burst Pressure		Min. Bend Radius		Weight	
	mm	in	mm	in	bar	psi	bar	psi	mm	in	kg/m	lbs/ft
FC639-04	6,4	0.25	12,7	0.50	210,0	3,050	840,0	12,200	50,0	1.97	0,22	0.15
FC639-06	9,5	0.38	16,6	0.65	210,0	3,050	840,0	12,200	65,0	2.56	0,34	0.23
FC639-08	12,7	0.50	20,9	0.82	210,0	3,050	840,0	12,200	90,0	3.54	0,47	0.32
FC639-10*	15,9	0.63	24,9	0.98	210,0	3,050	840,0	12,200	100,0	3.94	0,73	0.49
FC639-12*	19,1	0.75	28,4	1.12	210,0	3,050	840,0	12,200	120,0	4.72	0,83	0.56
FC639-16*	25,4	1.00	37,1	1.46	210,0	3,050	840,0	12,200	150,0	5.91	1,44	0.97

*Two wire braids of high tensile wire

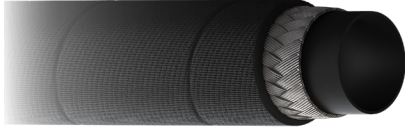

GH663

Premium
one wire braided hose

Exceeds: SAE 100R1 | EN 853 1SN performance | ISO 1436-1SN

Aeroquip by Danfoss	GH663-6	9.5 mm (0.38 in) DN10	Dura-Tuff	Exceeds SAE 100R1 / ISO 1436-1SN • MSHA IC-84/19 Exceeds EN 853 1 SN Performance • ABS • DNV • USCG+	235 BAR (3400 PSI)	-46°C to +126°C -50°F to +260°F	Half Bend	1A
---------------------	----------------	--------------------------	------------------	---	---------------------------	------------------------------------	-----------	----

Typical application:

Hydraulic system service with petroleum and water-based fluids, for general industrial service

Agency specifications:	ABS DNV MSHA USCG		
Hose construction:	Inner tube: Nitrile	Reinforcement: One wire braid	Cover: Dura-Tuff premium abrasion
Operating temperature:	-46°C to +126°C (-50°F to +260°F)		
Qualified fittings:	1A series		

PART #	SIZE DIMENSIONS				PRESSURE				BEND		WEIGHT	
	Hose I.D.		Hose O.D. (nominal)		Working Pressure		Min. Burst Pressure		Min. Bend Radius		Weight	
	mm	in	mm	in	bar	psi	bar	psi	mm	in	kg/m	lbs/ft
GH663-4	6,4	0.25	13,4	0.53	255,0	3,700	1,020	14,800	50,0	1.97	0,22	0.15
GH663-6	9,5	0.38	17,5	0.69	235,0	3,400	940	13,600	63,0	2.48	0,34	0.23
GH663-8	12,7	0.50	20,6	0.81	200,0	2,900	800	11,600	90,0	3.54	0,42	0.28
GH663-12	19,0	0.75	27,7	1.09	138,0	2,000	552	8,000	120,0	4.72	0,64	0.43
GH663-16	25,4	1.00	35,6	1.40	103,0	1,500	412	5,970	150,0	5.91	0,95	0.64
GH663-20	31,8	1.25	43,5	1.71	69,0	1,000	276	4,025	210,0	8.27	1,10	0.74
GH663-24	38,1	1.50	50,6	1.99	52,0	750	208	3,015	250,0	9.84	1,56	1.05
GH663-32	50,8	2.00	64,0	2.52	41,0	600	164	2,360	315,0	12.40	1,95	1.31

Core | **Premium** | Standard | Braided | **Spiral** | High-Temp | Low-Temp | Abrasion | Suction

Premium hose
FC849



FC849

Premium 4000 PSI constant pressure
two wire braided hose

Exceeds: SAE 100R19 Performance

	FC849-06	9.5 mm (0.38 in) DN10	Dura-Tuff	Exceeds SAE 100R19 Performance MSHA IC-84/19 - ABS - USCG +	275 BAR (4000 PSI)	-40°C to +100°C -40°F to +212°F	1A
--	-----------------	--------------------------	------------------	--	--------------------	------------------------------------	----

Typical application:

Industrial and hydraulic system applications with petroleum and water-based fluids

Recommended for use on construction, forestry, and other off-highway vehicles

Agency specifications: ABS | MSHA | USCG

Hose construction:	Inner tube: Nitrile	Reinforcement: Two wire braid	Cover: Dura-Tuff premium abrasion
---------------------------	-------------------------------	---	---

Operating temperature: -40°C to +100°C (-40°F to +212°F)

Qualified fittings: 1A series

PART #	SIZE DIMENSIONS				PRESSURE				BEND		WEIGHT	
	Hose I.D.		Hose O.D. (nominal)		Working Pressure		Min. Burst Pressure		Min. Bend Radius		Weight	
	mm	in	mm	in	bar	psi	bar	psi	mm	in	kg/m	lbs/ft
FC849-04	6,4	0.25	15,1	0.59	280,0	4,000	1,120	16,000	50,0	2.00	0,36	0.24
FC849-06	9,5	0.38	19,2	0.75	280,0	4,000	1,120	16,000	63,5	2.50	0,53	0.36
FC849-08	12,7	0.50	22,1	0.87	280,0	4,000	1,120	16,000	88,9	3.50	0,64	0.43
FC849-10	15,9	0.62	25,7	1.01	280,0	4,000	1,120	16,000	100,0	4.00	0,89	0.60
FC849-12	19,0	0.75	29,9	1.17	280,0	4,000	1,120	16,000	120,0	4.75	1,07	0.72



FC849B

Premium Bruiser ultra-abrasion 4000 PSI constant pressure two wire braided hose

Exceeds: SAE 100R19 Performance

Aeroquip by Danfoss	FC849B-04	6.4 mm (0.25 in) DN6	Bruiser	Exceeds SAE 100R19 Performance MSHA IC-84/71	275 BAR (4000 PSI)	-40°C to +100°C -40°F to +212°F	1A
---------------------	------------------	-------------------------	----------------	---	--------------------	------------------------------------	----

Typical application:

Ultra-abrasion industrial and hydraulic system applications with petroleum and water-based fluids

Recommended for use on critical applications in construction, forestry, and other off-highway vehicles

Agency specifications:	MSHA		
Hose construction:	Inner tube: Nitrile	Reinforcement: Two wire braid	Cover: Bruiser ultra-abrasion
Operating temperature:	-40°C to +100°C (-40°F to +212°F)		
Qualified fittings:	1A series		

PART #	SIZE DIMENSIONS				PRESSURE				BEND		WEIGHT	
	Hose I.D.		Hose O.D. (nominal)		Working Pressure		Min. Burst Pressure		Min. Bend Radius		Weight	
	mm	in	mm	in	bar	psi	bar	psi	mm	in	kg/m	lbs/ft
FC849B-04	6,4	0.25	15,1	0.59	275	4,000	1,000	16,000	50,8	2.00	0,37	0.25
FC849B-06	9,5	0.38	19,2	0.75	275	4,000	1,000	16,000	63,5	2.50	0,52	0.35
FC849B-08	12,7	0.50	22,1	0.87	275	4,000	1,000	16,000	88,9	3.50	0,64	0.43
FC849B-10	15,9	0.63	25,7	1.01	275	4,000	1,000	16,000	101,6	4.00	0,91	0.61
FC849B-12	19,0	0.75	29,8	1.17	275	4,000	1,000	16,000	120,7	4.75	1,07	0.72

Premium hose
FC510

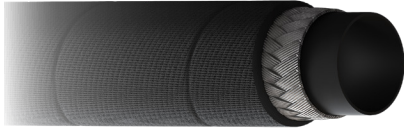

FC510

Premium AQP high-temp HI-PAC
one wire braided hose

Exceeds: EN 857 1SC

	FC510-04	6.4 mm (0.25 in) DN6	AQP High-Temp HI-PAC	Exceeds EN 857 1SC MSHA IC-84/18 • DNV • USCG +	↻ 345 BAR (5000 PSI)	-40°C to +149°C -40°F to +300°F	1A
--	-----------------	-------------------------	-------------------------	--	----------------------	------------------------------------	----

Typical application:

Petroleum and fire-resistant hydraulic fluids, fuel, and lubricating systems

Agency specifications: DNV | MSHA | USCG

Hose construction:	Inner tube: AQP Elastomer	Reinforcement: HI-PAC one wire braid	Cover: AQP high-temp
---------------------------	--	--	-----------------------------------

Operating temperature: -40°C to +150°C (-40°F to +300°F)

Qualified fittings: 1A series

PART #	SIZE DIMENSIONS				PRESSURE				BEND		WEIGHT	
	Hose I.D.		Hose O.D. (nominal)		Working Pressure		Min. Burst Pressure		Min. Bend Radius		Weight	
	mm	in	mm	in	bar	psi	bar	psi	mm	in	kg/m	lbs/ft
FC510-04	6,4	0.25	14,5	0.57	345,0	5,000	1,380	20,000	76,2	3.00	0,34	0.23
FC510-06	9,5	0.38	17,6	0.69	275,0	4,000	1,100	16,000	88,9	3.50	0,43	0.29
FC510-08	12,7	0.50	20,2	0.80	240,0	3,500	960	14,000	127,0	5.00	0,50	0.34
FC510-10	15,9	0.63	23,9	0.93	190,0	2,750	760	11,000	152,4	6.00	0,66	0.44
FC510-12	19,0	0.75	27,7	1.09	155,0	2,250	620	9,000	177,8	7.00	0,77	0.52
FC510-16	25,4	1.00	34,6	1.37	138,0	2,000	552	8,000	228,6	9.00	1,05	0.71
FC510-20	31,8	1.25	43,1	1.70	112,0	1,625	448	6,500	279,4	11.00	1,61	1.08

Core | **Premium** | Standard | Braided | Spiral | High-Temp | Low-Temp | Abrasion | Suction

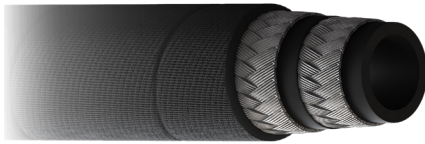

GH793

Premium
two wire braided hose

Exceeds: SAE 100R2 | EN 853 2SN Performance | ISO 1436 2SN

by Danfoss	GH793-4	6.4 mm (0.25 in) DN6	Dura-Tuff	Exceeds SAE 100R2 / ISO 1436 2SN + MSHA IC-84/19 Exceeds EN 853 2SN Performance + USCG +	448 BAR (6500 PSI)	-40°C to +126°C -40°F to +260°F	1A 2R
------------	----------------	-------------------------	------------------	---	---------------------------	------------------------------------	----------

Typical application:

Hydraulic system service with petroleum and water-based fluids, for general industrial service



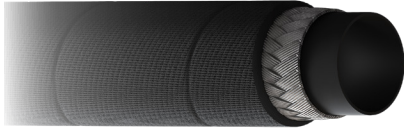

Agency specifications:	ABS MSHA USCG		
Hose construction:	Inner tube: Nitrile	Reinforcement: Two wire braid	Cover: Dura-Tuff premium abrasion
Operating temperature:	-40°C to +126°C (-40°F to +260°F)		
Qualified fittings:	1A series 2R series		

PART #	SIZE DIMENSIONS				PRESSURE				BEND		WEIGHT	
	Hose I.D.		Hose O.D. (nominal)		Working Pressure		Min. Burst Pressure		Min. Bend Radius		Weight	
	mm	in	mm	in	bar	psi	bar	psi	mm	in	kg/m	lbs/ft
GH793-4	6,4	0.25	15,1	0.59	448,0	6,500	1,792	26,000	100,0	4.00	0,39	0.26
GH793-6	9,5	0.38	19,1	0.75	400,0	5,800	1,600	23,200	130,0	5.00	0,56	0.38
GH793-8	12,7	0.50	22,2	0.87	345,0	5,000	1,380	20,000	180,0	7.00	0,68	0.46
GH793-10	15,9	0.63	25,5	1.01	276,0	4,000	1,104	16,000	200,0	8.00	0,80	0.54
GH793-12	19,0	0.75	29,5	1.16	241,0	3,500	964	14,000	240,0	9.50	0,98	0.66
GH793-16	25,4	1.00	38,1	1.50	207,0	3,000	828	12,000	300,0	12.00	1,50	1.01
GH793-20	31,8	1.25	48,1	1.39	172,0	2,500	688	10,000	420,0	16.50	2,29	1.54
GH793-24	38,1	1.50	54,7	2.15	138,0	2,000	552	8,000	500,0	20.00	2,50	1.68
GH793-32	50,8	2.00	67,5	2.66	110,0	1,600	440	6,400	630,0	25.00	3,30	2.22

Premium hose
FC611



FC611 | Premium EPDM
one wire braided hose

FC611-12 19.0 mm (0.75 in) DN19 Phosphate Ester  **86 BAR (1250 PSI)**  -40°C to +79°C (-40°F to +175°F)  1A 

Typical application:

Ground support equipment (GSE), industrial phosphate ester-based fluids, water glycol systems

Agency specifications:

Hose construction:	Inner tube: EPDM	Reinforcement: One wire braid	Cover: EPDM
Operating temperature:	-40°C to +79°C (-40°F to +175°F)		
Qualified fittings:	1A series		

PART #	SIZE DIMENSIONS				PRESSURE				BEND		WEIGHT	
	Hose I.D.		Hose O.D. (nominal)		Working Pressure		Min. Burst Pressure		Min. Bend Radius		Weight	
	mm	in	mm	in	bar	psi	bar	psi	mm	in	kg/m	lbs/ft
FC611-12	19,0	0.75	27,9	1.09	87,0	1,250	344	5,000	241,0	9.50	0,63	0.43
FC611-16	25,4	1.00	35,7	1.40	70,0	1,000	280	4,000	305,0	12.00	0,89	0.60
FC611-20	31,8	1.25	44,0	1.73	43,0	625	172	2,500	419,0	16.50	1,13	0.80
FC611-24	38,1	1.50	50,6	1.99	35,0	500	140	2,000	508,0	20.00	1,52	1.02
FC611-32	50,8	2.00	64,0	2.51	26,0	375	104	1,500	635,0	25.00	1,91	1.28

Core | **Premium** | Standard | **Braided** | Spiral | High-Temp | Low-Temp | Abrasion | Suction

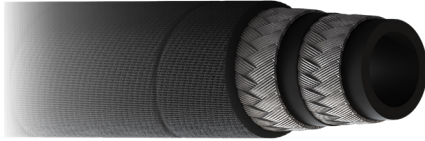

FC693

Premium EPDM
two wire braided hose

Aeroquip by Danfoss **FC693-04** 6.4 mm (0.25 in) DN6 **345 BAR (5000 PSI)** -40°C to +79°C / -40°F to +175°F 1A

Typical application:

Ground support equipment (GSE), industrial phosphate ester-based fluids, water glycol systems

Agency specifications:

Hose construction:	Inner tube: EPDM	Reinforcement: Two wire briad	Cover: EPDM
---------------------------	----------------------------	---	-----------------------

Operating temperature: -40°C to +79°C (-40°F to +175°F)

Qualified fittings: 1A series

PART #	SIZE DIMENSIONS				PRESSURE				BEND		WEIGHT	
	Hose I.D.		Hose O.D. (nominal)		Working Pressure		Min. Burst Pressure		Min. Bend Radius		Weight	
	mm	in	mm	in	bar	psi	bar	psi	mm	in	kg/m	lbs/ft
FC693-04	6,4	0.25	15,1	0.59	345,0	5,000	1,380	20,000	102,0	4.00	0,37	0.25
FC693-06	9,5	0.38	19,2	0.75	275,0	4,000	1,100	16,000	127,0	5.00	0,54	0.36
FC693-08	12,7	0.50	22,1	0.87	240,0	3,500	960	14,000	178,0	7.00	0,60	0.40

Premium hose
EC502

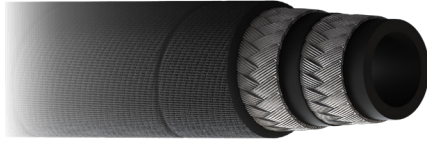

EC502 | Premium LifeSense™
two wire braided hose

Exceeds: SAE 100R2 | EN 853 2SN

EC502-08 12.7 mm (0.50 in) DN12
 
 Exceeds SAE 100R2 / EN 853 2SN Performance MSHA IC-84/19
  293 BAR (4250 PSI)
  -40°C to +100°C
-40°F to +212°F
  3L  

Typical application:

- General hydraulics
- Agricultural equipment – turf care
- Vocational fleets – mobile refuse, mobile cement mixers
- Manufacturing – stationary machining centers

Agency specifications:

MSHA

Hose construction:

Inner tube:
Nitrile

Reinforcement:
Two wire braid

Cover:
Nitrile

Operating temperature:

-40°C to +100°C (-40°F to +212°F)

Qualified fittings:

3L series

PART #	SIZE DIMENSIONS				PRESSURE				BEND		WEIGHT	
	Hose I.D.		Hose O.D. (nominal)		Working Pressure		Min. Burst Pressure		Min. Bend Radius		Weight	
	mm	in	mm	in	bar	psi	bar	psi	mm	in	kg/m	lbs/ft
EC502-08	12,7	0.50	23,6	0.92	293	4,250	1,172	17,000	177,8	7.0	0,74	0.50
EC502-12	19,0	0.75	30,0	1.18	215	3,125	860	12,500	241,3	9.5	0,98	0.66
EC502-16	25,4	1.00	37,9	1.49	172	2,500	690	10,000	304,8	12.0	1,47	0.99



FC579

Premium Hi-impulse jack
two wire braided hose

Meets: IJ100

	FC579-04	6.4 mm (0.25 in) DN6	Dura-Tuff	MSHA IC-84/19	↻ 690 BAR (10000 PSI)	 -40°C to +49°C -40°F to +120°F	1A
--	-----------------	-------------------------	------------------	---------------	-----------------------	---------------------------------------	----

Typical application:

Hydraulic jacking system service with petroleum and water-based fluids
Meets the performance requirements of the Material Handling Institute Specification IJ100

Agency specifications:	MSHA		
Hose construction:	Inner tube: Nitrile	Reinforcement: Two wire braid	Cover: Dura-Tuff premium abrasion
Operating temperature:	-40°C to +49°C (-40°F to +120°F)		
Qualified fittings:	1A series		

PART #	SIZE DIMENSIONS				PRESSURE				BEND		WEIGHT	
	Hose I.D.		Hose O.D. (nominal)		Working Pressure		Min. Burst Pressure		Min. Bend Radius		Weight	
	mm	in	mm	in	bar	psi	bar	psi	mm	in	kg/m	lbs/ft
FC579-04	6,4	0.25	14,1	0.56	690,0	10,000	1,380	20,000	50,8	2.00	0,33	0.22
FC579-06	9,5	0.38	19,2	0.76	690,0	10,000	1,380	20,000	63,5	2.50	0,57	0.38

Premium hose
EC230

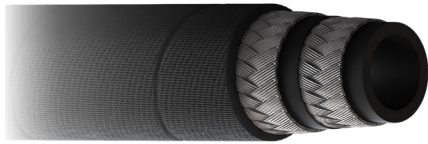

EC230 | Premium large bore
two wire braided hose

Exceeds: SAE 100R2

Aeroquip by Danfoss	EC230-40	63.5 mm (2.50 in) DN60	Dura-Tuff	Exceeds SAE 100R2 Performance MSHA IC-84/19	79 BAR (1150 PSI)	-40°C to +100°C -40°F to +212°F	
----------------------------	-----------------	---------------------------	------------------	--	--------------------------	------------------------------------	--

Typical application:

Hydraulic system service with petroleum and waterbased fluids, for general industrial service

Agency specifications: MSHA

Hose construction:	Inner tube: Nitrile	Reinforcement: Two wire braid	Cover: Dura-Tuff premium abrasion
---------------------------	-------------------------------	---	--

Operating temperature: -40°C to +100°C (-40°F to +212°F)

Qualified fittings: For fitting information, see your Danfoss representative.

PART #	SIZE DIMENSIONS				PRESSURE				BEND		WEIGHT	
	Hose I.D.		Hose O.D. (nominal)		Working Pressure		Min. Burst Pressure		Min. Bend Radius		Weight	
	mm	in	mm	in	bar	psi	bar	psi	mm	in	kg/m	lbs/ft
EC230-40	63,5	2.50	78,6	3.09	79,0	1,150	316	4,600	660,0	26.00	3,88	2.61



FC254

Premium
four wire spiral hose

Exceeds: EN 856 4SP

Aeroquip by Danfoss **FC254-12** 19,0 mm (0,76 in) DN19 **Dura-Tuff** Exceeds EN 856 4SP - ABS MSHA IC-84/19 - USCG + **497 BAR (7200 PSI)** -46°C to +126°C -50°F to +260°F **1W 4S**

Typical application:

For general use with hydraulic system service with petroleum and water-based fluids

Agency specifications:	ABS MSHA USCG		
Hose construction:	Inner tube: Nitrile	Reinforcement: Four wire spiral	Cover: Dura-Tuff premium abrasion
Operating temperature:	-46°C to +126°C (-50°F to +260°F)		
Qualified fittings:	1W series (-08) 4S series (-12 to -32)		

PART #	SIZE DIMENSIONS				PRESSURE				BEND		WEIGHT	
	Hose I.D.		Hose O.D. (nominal)		Working Pressure		Min. Burst Pressure		Min. Bend Radius		Weight	
	mm	in	mm	in	bar	psi	bar	psi	mm	in	kg/m	lbs/ft
FC254-08	12,7	0.50	24,8	0.98	530,0	7,700	2,120	30,800	203,0	8.0	1,07	0.72
FC254-12	19,0	0.75	32,0	1.26	497,0	7,200	1,988	28,800	279,0	11.0	1,58	1.06
FC254-16	25,4	1.00	38,6	1.52	415,0	6,000	1,660	24,000	305,0	12.0	1,96	1.32
FC254-20	31,8	1.25	45,2	1.78	350,0	5,100	1,400	20,400	419,0	16.5	2,43	1.63
FC254-24	38,1	1.50	54,1	2.13	300,0	4,350	1,200	17,400	508,0	20.0	3,02	2.03
FC254-32	50,8	2.00	68,0	2.68	275,0	4,000	1,100	16,000	635,0	25.0	4,49	3.02

Premium hose
GH506

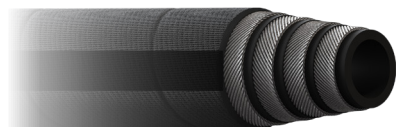

GH506

Premium
four wire spiral hose

Meets: EN 856 4SH | ISO 3862 4SH | ISO 18752

Aeroquip by Danfoss	GH506-12	19.0 mm (0.75 in) DN19	Dura-Tuff	EN 856 4SH • ISO 3862 4SH • ISO 18752 MSHA IC-84/19 • ABS • DNV	420 BAR (6100 PSI)	-40°C to +100°C -40°F to +212°F	1W
---------------------	-----------------	---------------------------	------------------	--	--------------------	------------------------------------	----

Typical application:

High pressure hydraulic systems with petroleum and water-based fluids

Agency specifications:

ABS | DNV | MSHA

Hose construction:

Inner tube:
Nitrile

Reinforcement:
Four wire spiral

Cover:
Dura-Tuff
premium abrasion

Operating temperature:

-40°C to +100°C (-40°F to +212°F)

Qualified fittings:

1W series | 4S series

PART #	SIZE DIMENSIONS				PRESSURE				BEND		WEIGHT	
	Hose I.D.		Hose O.D. (nominal)		Working Pressure		Min. Burst Pressure		Min. Bend Radius		Weight	
	mm	in	mm	in	bar	psi	bar	psi	mm	in	kg/m	lbs/ft
GH506-12	19,0	0.75	32,2	1.27	420,0	6,100	1,680	24,400	280,0	11.02	1,49	1.00
GH506-16	25,4	1.00	38,3	1.51	420,0	6,100	1,680	24,400	340,0	13.39	2,05	1.38
GH506-20	31,8	1.25	45,5	1.79	350,0	5,100	1,400	20,400	460,0	18.11	2,54	1.71
GH506-24	38,1	1.50	53,5	2.11	300,0	4,350	1,200	17,400	560,0	22.05	3,27	2.20
GH506-32	50,8	2.00	68,1	2.68	250,0	3,650	1,000	14,500	700,0	27.56	4,58	3.08

Core | **Premium** | Standard | Braided | **Spiral** | High-Temp | Low-Temp | Abrasion | Suction



FC606

Premium
six wire spiral hose

Exceeds: SAE 100R15 | ISO 3862 R15

Aeroquip by Danfoss	FC606-24	38.1 mm (1.50 in) DN38	Dura-Tuff	SAE 100R15 • ISO 3862 R15 MSAHC-84/19	420 BAR (6100 PSI)	-40°C to +121°C -40°F to +250°F	6S
---------------------	-----------------	---------------------------	------------------	--	---------------------------	------------------------------------	-----------

Typical application:

High-pressure hydraulics, hydrostatic transmissions
Hydraulic system service with petroleum and water-based fluids for general industrial use

Agency specifications:	ABS MSHA		
Hose construction:	Inner tube: Nitrile	Reinforcement: Six wire spiral	Cover: Dura-Tuff premium abrasion
Operating temperature:	-40°C to +121°C (-40°F to +250°F)		
Qualified fittings:	6S series		

PART #	SIZE DIMENSIONS				PRESSURE				BEND		WEIGHT	
	Hose I.D.		Hose O.D. (nominal)		Working Pressure		Min. Burst Pressure		Min. Bend Radius		Weight	
	mm	in	mm	in	bar	psi	bar	psi	mm	in	kg/m	lbs/ft
FC606-24	38,1	1.50	58,4	2.30	420,0	6,100	1,680	24,400	508,0	20.00	4,72	3.17



Premium hose
GH466



GH466

Premium
six wire spiral hose

Exceeds: SAE 100R15 | EN 856 R13 | ISO 18752

Aeroquip by Danfoss **GH466-24**
38,1 mm (1,50 in) DN38
Dura-Tuff
2M Cycles
Exceeds SAE 100R15 / EN 856 R13
MSHA IC-84/19 • ABS • DNV
↻ 420 BAR (6100 PSI)
-40°C to +121°C
-40°F to +250°F
1W 

Typical application:

High pressure hydraulic systems with extreme pressure peaks. For use with petroleum and water-based fluids

Agency specifications:

ABS | DNV | MSHA

Hose construction:

Inner tube:
Nitrile

Reinforcement:
Six wire spiral

Cover:
Dura-Tuff
premium abrasion

Operating temperature:

-40°C to +121°C (-40°F to +250°F)

Qualified fittings:

6S series (-20, -24)
1W series (ALL)

PART #	SIZE DIMENSIONS				PRESSURE				BEND		WEIGHT	
	Hose I.D.		Hose O.D. (nominal)		Working Pressure		Min. Burst Pressure		Min. Bend Radius		Weight	
	mm	in	mm	in	bar	psi	bar	psi	mm	in	kg/m	lbs/ft
GH466-20	31,8	1,25	49,4	1,94	420,0	6,100	1,680	24,400	420,0	16,53	3,48	2,34
GH466-24	38,1	1,50	57,3	2,26	420,0	6,100	1,680	24,400	500,0	19,69	4,63	3,11
GH466-32*	50,8	2,00	71,7	2,82	420,0	6,100	1,680	24,400	630,0	24,80	6,70	4,50

*only qualified with 1W fittings



FC636

Premium
four wire spiral hose

Meets or exceeds: SAE 100R12



FC636-12

19.0 mm (0.75 in)
DN19

Phosphate Ester

275 BAR (4000 PSI)

-40°C to +79°C
-40°F to +175°F

4S

Typical application:

Ground support equipment (GSE), industrial phosphate ester based fluids, water glycol systems

Agency specifications:

Hose construction:	Inner tube: EPDM	Reinforcement: Four wire spiral	Cover: EPDM
---------------------------	----------------------------	---	-----------------------

Operating temperature: -40°C to +79°C (-40°F to +175°F)

Qualified fittings: 4S series

PART #	SIZE DIMENSIONS				PRESSURE				BEND		WEIGHT	
	Hose I.D.		Hose O.D. (nominal)		Working Pressure		Min. Burst Pressure		Min. Bend Radius		Weight	
	mm	in	mm	in	bar	psi	bar	psi	mm	in	kg/m	lbs/ft
FC636-12	19,0	0.75	30,7	1.21	275,0	4,000	1,100	16,000	241,0	9.50	1,31	0.88
FC636-16	25,4	1.00	37,9	1.49	275,0	4,000	1,100	16,000	305,0	12.00	1,74	1.17
FC636-20	31,8	1.25	46,6	1.83	207,0	3,000	828	12,000	419,0	16.50	2,31	1.55
FC636-24	38,1	1.50	53,9	2.12	172,0	2,500	688	10,000	508,0	20.00	2,92	1.96

Premium hose
EC850

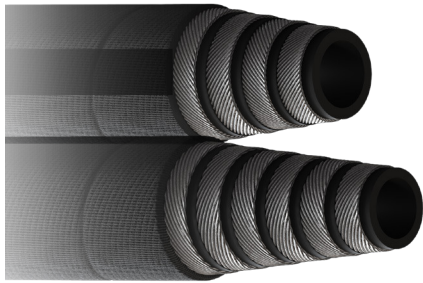

EC850

Premium Dynamax ultra-performance
four & six wire spiral hose

Meets: SAE 100R15 | EN 856 R13 | ISO 18752

Aeroquip by Danfoss	EC850-12	19.0 mm (0.75 in) DN19	Dura-Tuff Dynamax	Exceeds SAE 100R15 / EN 856 R13 Type ISO 18752 • MSHA IC-84/56	500 BAR (7250 PSI)	-40°C to +100°C -40°F to +212°F	1W
----------------------------	-----------------	---------------------------	------------------------------	---	---------------------------	------------------------------------	-----------

Typical application:

Ultra high pressure
Hydraulic systems with petroleum
and water-glycol based fluids
Lubricating oils and water

Agency specifications:	MSHA		
Hose construction:	Inner tube: Nitrile	Reinforcement: Four wire spiral (-10, -12, -16) Six wire spiral (-20)	Cover: Dura-Tuff premium abrasion
Operating temperature:	-40°C to +100°C (-40°F to +212°F)		
Qualified fittings:	1W series		

PART #	SIZE DIMENSIONS				PRESSURE				BEND		WEIGHT	
	Hose I.D.		Hose O.D. (nominal)		Working Pressure		Min. Burst Pressure		Min. Bend Radius		Weight	
	mm	in	mm	in	bar	psi	bar	psi	mm	in	kg/m	lbs/ft
EC850-10	15,9	0.62	27,9	1.10	500	7,250	2,000	29,000	200,0	7.87	1,23	0.82
EC850-12	19,0	0.75	32,2	1.27	500	7,250	2,000	29,000	215,0	8.46	1,52	1.01
EC850-16	25,4	1.00	39,2	1.54	500	7,250	2,000	29,000	270,0	10.63	2,31	1.54
EC850-20**	31,8	1.25	49,4	1.94	500	7,250	2,000	29,000	380,0	14.96	4,01	2.69

** Six wire spiral

Core | **Premium** | Standard | Braided | **Spiral** | High-Temp | Low-Temp | Abrasion | Suction



EC910

Premium SafeShield Waterblast
four wire spiral hose

Meets: ISO 7751 | EN 1829-2 (impulse)

EC910-08 12.7 mm (0.50 in) DN12 **Dura-Tuff** ISO 7751 / EN 1829-2 IMPULSE MSHA IC-84/43 **1100 BAR (16000 PSI)** -40°C to +93°C / -40°F to +200°F **1W**

Typical application:

Waterblast service with water, water-soap, emulsion

Agency specifications:	MSHA		
Hose construction:	Inner tube: Nitrile	Reinforcement: Four wire spiral	Cover: Dura-Tuff premium abrasion with WJTA* color-coded laylines
Operating temperature:	-40°C to +93°C (-40°F to +200°F) Continuous service temperature range -10°C to +80°C (-14°F to +176°F)		
Qualified fittings:	1W series		

*Water Jetting Technology Association

PART #	SIZE DIMENSIONS				PRESSURE				BEND		WEIGHT	
	Hose I.D.		Hose O.D. (nominal)		Working Pressure		Min. Burst Pressure		Min. Bend Radius		Weight	
	mm	in	mm	in	bar	psi	bar	psi	mm	in	kg/m	lbs/ft
EC910-08C50	12,7	0.50	24,6	0.97	1,100	16,000	2,750	40,000	228,6	9.00	1,12	0.75
EC910-12C50	19,0	0.75	32,8	1.29	1,000	14,500	2,500	36,250	279,4	11.00	1,74	1.17
EC910-16C50	25,4	1.00	39,9	1.57	700	10,200	1,750	25,500	304,8	12.00	2,23	1.50

* 50 foot cut lengths (orders must be placed in 50 foot increments)

Premium hose
FC619

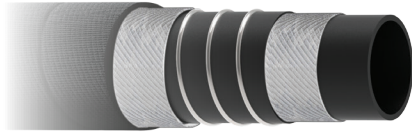

Suction

FC619

Premium suction hose

Exceeds: SAE 100R4 | EN 45545

FC619-12
19.0 mm (0.75 in) DN19
Dura-Tuff
Exceeds SAE 100R4 • ABS MSHA IC-84/19 • EN 45545
21 BAR (305 PSI)
-40°C to +135°C
-40°F to +275°F
1/3 BEND 4S • 1A 1G

Typical application:

Suction and transfer applications for petroleum hydraulic fluids, fuel, lubricating oils, gasoline, water and many other industrial fluids

Agency specifications: ABS | MSHA | USCG

Hose construction:	Inner tube: AQP elastomer	Reinforcement: Helical wire between two textile reinforcement layers	Cover: Dura-Tuff premium abrasion
---------------------------	-------------------------------------	--	---

Operating temperature: -40°C to +135°C (-40°F to +275°F)

Qualified fittings: 1A series (-12 to -32) | 4S series (-12) | 1G series (-12 to -32)

PART #	SIZE DIMENSIONS				PRESSURE				BEND		VACUUM		WEIGHT	
	Hose I.D.		Hose O.D. (nominal)		Working Pressure		Min. Burst Pressure		Min. Bend Radius		Vacuum Service		Weight	
	mm	in	mm	in	bar	psi	bar	psi	mm	in	kg/m	lbs/ft	kg/m	lbs/ft
FC619-12	19,0	0.75	30,0	1.18	21,0	305 †	84,0	1,200	40,0	1.57	94,8	28	0,65	0.44
FC619-16	25,4	1.00	37,1	1.46	17,0	245 †	68,0	1,000	45,0	1.77	94,8	28	0,77	0.52
FC619-20	31,8	1.25	44,8	1.76	14,0	205 †	56,0	820	60,0	2.36	94,8	28	1,12	0.75
FC619-24	38,1	1.50	51,2	2.01	10,5	150 †	42,0	600	65,0	2.56	94,8	28	1,26	0.85
FC619-32	50,8	2.00	64,8	2.55	7,0	100 †	28,0	400	100,0	3.94	94,8	28	1,73	1.16
FC619-40	63,5	2.50	77,7	3.06	4,0	60 †	16,0	240	140,0	5.51	94,8	28	2,35	1.58
FC619-48	76,2	3.00	92,5	3.64	4,0	60 †	16,0	240	279,4	11.00	94,8	28	3,36	2.26

† Maximum working pressure for band clamp type fittings is 3,4 bar [50 psi].

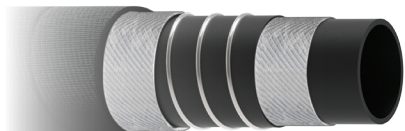

2661

Premium high-temp suction hose

Meets: SAE 100R4

2661-12	19.0 mm (0.75 in) DN19	AQP High-Temp	Exceeds SAE 100R4 MSHA IC-84/19 • USCG +	↻ 21 BAR (305 PSI)	-40°C to +150°C -40°F to +300°F	1A 1G
----------------	------------------------	---------------	--	--------------------	------------------------------------	----------

Typical application:

Suction and transfer applications for petroleum hydraulic fluids, fuel, lubricating oils, gasoline, water and many other industrial fluids

Agency specifications:	ABS MSHA USCG		
Hose construction:	Inner tube: AQP elastomer	Reinforcement: Helical wire between two textile reinforcement layers	Cover: AQP high-temp
Operating temperature:	-40°C to +149°C (-40°F to +300°F)		
Qualified fittings:	1A series 1G series		

PART #	SIZE DIMENSIONS				PRESSURE				BEND		VACUUM		WEIGHT	
	Hose I.D.		Hose O.D. (nominal)		Working Pressure		Min. Burst Pressure		Min. Bend Radius		Vacuum Service		Weight	
	mm	in	mm	in	bar	psi	bar	psi	mm	in	kg/m	lbs/ft	kg/m	lbs/ft
2661-12	19,0	0.75	31,8	1.25	21,0	305 †	84,0	1,205	125,0	4.92	94,8	28	0,62	0.42
2661-16	25,4	1.00	38,0	1.50	17,5	255 †	70,0	1,000	150,0	5.91	94,8	28	0,74	0.50
2661-20	31,8	1.25	45,8	1.80	14,0	205 †	56,0	810	200,0	7.87	94,8	28	1,34	0.90
2661-24	38,1	1.50	53,1	2.09	11,0	160 †	44,0	640	255,0	10.04	94,8	28	1,68	1.13
2661-32	50,8	2.00	64,8	2.55	7,0	100 †	28,0	400	300,0	11.81	94,8	28	1,93	1.30
2661-40	63,5	2.50	78,0	3.07	4,5	65 †	18,0	260	355,0	13.98	94,8	28	2,56	1.72
2661-48 ‡	76,2	3.00	92,5	3.64	4,0	60 †	16,0	230	457,0	17.99	94,8	28	2,92	1.96
2661-64 ‡	101,6	4.00	119,1	4.69	3,5	50 †	14,0	205	610,0	24.02	94,8	28	4,58	3.08

† Maximum working pressure for band clamp type fittings is 3,4 bar [50 psi].

‡ Sold as bulk hose only.









Winner

Table of contents

The **standard** hoses

Core hose 

Hose	Page	Hose	Page	Hose	Page
EC115 Standard one wire braided hose 	78	EC415 Standard four wire spiral hose 	81	WH004 Standard suction hose 	83
EC215 Standard two wire braided hose 	79	EC420 Standard four & six wire spiral hose 	82		
EC118 Premium one & two wire braided hose 	80				

How to order

Accurate processing and prompt delivery of your order depends on easy identification of your requirements. Please order Aeroquip brand parts using correct part numbers as described in this guide. Inquiries and orders should be directed to your Aeroquip distributor or:

www.Danfoss.com/hydraulics

Part numbers and dash sizes

Dash size designates the nominal size in 16th of an inch. This number immediately follows the part number and is separated from it with a dash.

Dimensions

Dimensions given in this guide for Aeroquip products are approximate and should be used for reference only. Exact dimensional information for a given product is subject to change and varying tolerances; contact Danfoss directly for full current information.

Number system - hydraulic hose

Cut lengths hoses are available only on core hose products. Available cut lengths are 50, 100, and 150 ft. The feet should be expressed in inches:

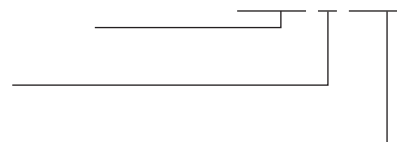

50 ft = 06000

100 ft = 12000

150 ft = 18000

Last digit is in 1/8 of an inch 00484 = 48 1/2 inches

Most core hoses are offered on reels of 250 or 500 ft lengths.

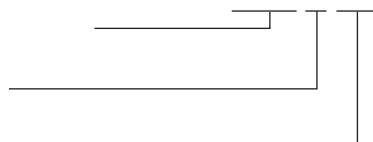

WARNING

Hose assemblies

Danfoss manufactures the terminal ends of our hose fittings to the appropriate requirements established by the SAE. Therefore, the performance ratings of these hose fittings meet the SAE requirements. It is possible to order a hose assembly with a fitting terminal end that has a performance rating lower than the hose rating. When ordering hose assemblies, please keep the connecting end performance rating in mind since this may affect overall hose assembly performance. Hose assembly components (hose and fittings) are easily assembled in the field. However, factory assembled field attachable and crimped hose assemblies are available.

For complete information, contact Danfoss.

Winner

Standard core hose EC115



Standard

EC115

Winner
one wire braid hose

Meets: SAE 100R1 | EN 857 Type 1SC

Winner by Danfoss

EC115-08

12.7 MM (0.50 IN)
DN12

SAE 100R1 - EN 857 1SC
MSHA IC-84/25 DNV - USCG +

160 BAR (2300 PSI)

-40°C to +100°C
-40°F to +212°F

Half Bend

1A - Z
2PC - 1R

Typical application:

Hydraulic system service with petroleum and water based fluids, for general industrial service.

Agency specifications:

DNV | MSHA | USCG

Hose construction:

Inner tube:
Nitrile

Reinforcement:
One wire braid

Cover:
Nitrile

Operating temperature:

-40°C to +100°C (-40°F to +212°F)

Qualified fittings/socket:

Fittings: 1A series | 2-piece Winner | 1R field attachable
Socket: 00110 (pg 173)

PART	SIZE DIMENSIONS				PRESSURE				BEND		WEIGHT	
	Hose I.D.		Hose O.D. (nominal)		Working Pressure		Min. Burst Pressure		Min. Bend Radius		Weight	
#	mm	in	mm	in	bar	psi	bar	psi	mm	in	kg/m	lbs/ft
EC115-04	6.4	0.25	12.6	0.50	225	3,250	900	13,000	50,0	1.97	0.18	0.12
EC115-06	9.5	0.38	16.1	0.63	180	2,600	720	10,400	63,0	2.48	0.26	0.17
EC115-08	12.7	0.50	19.5	0.77	160	2,300	640	9,200	90,0	3.54	0.34	0.23
EC115-10	15.9	0.62	22.5	0.88	130	1,900	520	7,600	100,0	3.94	0.42	0.28
EC115-12	19.0	0.75	26.0	1.02	105	1,525	420	6,100	120,0	4.72	0.50	0.34
EC115-16	25.4	1.00	33.9	1.33	88	1,275	352	5,100	160,0	6.30	0.74	0.50
EC115-20	31.8	1.25	40.9	1.61	63	925	252	3,700	210,0	8.27	0.99	0.67
EC115-24	38.1	1.50	48.0	1.89	50	725	300	4,350	300,0	11.81	1.20	0.81
EC115-32	50.8	2.00	61.0	2.40	40	580	220	3,190	400,0	15.75	1.50	1.01

Core

Premium

Standard

Braided

Spiral

High-Temp

Low-Temp

Abrasion

Suction



✓ Standard

EC215 | Winner
two wire braid hose

Meets: EN 857 2SC | ISO 18752

Winner by Danfoss **EC215-06**

9.5 mm (0.38 in)
DN10

EN 857 2SC • ISO 18752
MSHA IC-84/41 • DNV • USCG +

↻ 345 BAR (5000 PSI)

🌡️ -40°C to +100°C
-40°F to +212°F

📏 Half Bend

1A-Z
2R-2PC

Typical application:

Hydraulic system service with petroleum and water based fluids, for general industrial service.

Agency specifications:	DNV MSHA USCG		
Hose construction:	Inner tube: Nitrile	Reinforcement: Two wire braid	Cover: Nitrile
Operating temperature:	-40°C to +100°C (-40°F to +212°F)		
Qualified fittings/socket:	Fittings: 1A series 2-piece Winner 2R field attachable Socket: 03310 (pg 173)		

PART #	SIZE DIMENSIONS				PRESSURE				BEND		WEIGHT	
	Hose I.D.		Hose O.D. (nominal)		Working Pressure		Min. Burst Pressure		Min. Bend Radius		Weight	
	mm	in	mm	in	bar	psi	bar	psi	mm	in	kg/m	lbs/ft
EC215-04	6.4	0.25	13.5	0.53	400	5,800	1,600	23,200	50,0	1.97	0.28	0.19
EC215-06	9.5	0.38	17.5	0.69	345	5,000	1,380	20,000	65,0	2.56	0.41	0.28
EC215-08	12.7	0.50	20.8	0.82	275	4,000	1,100	16,000	90,0	3.54	0.57	0.38
EC215-10	15.9	0.62	24.0	0.94	250	3,650	1,000	14,600	100,0	3.94	0.68	0.46
EC215-12	19.0	0.75	27.9	1.10	215	3,125	860	12,500	120,0	4.72	0.81	0.54
EC215-16	25.4	1.00	35.7	1.41	165	2,400	660	9,600	160,0	6.30	1.17	0.79
EC215-20	31.8	1.25	43.9	1.73	125	1,800	500	7,200	250,0	9.84	1.56	1.05
EC215-24	38.1	1.50	51.0	2.01	100	1,450	400	5,800	300,0	11.81	1.81	1.22
EC215-32	50.8	2.00	63.4	2.50	90	1,300	380	5,500	400,0	15.75	2.36	1.59

Core | Premium | **Standard** | Braided | Spiral | High-Temp | Low-Temp | Abrasion | Suction

Winner

Standard core hose EC118



✓ Standard

EC118 | Winner
one & two wire braid hose

Meets: SAE 100R17 | ISO 18752

Winner by Danfoss **EC118-08**

12.7 mm (0.50 in)
DN12

SAE 100R17 • ISO 18752
MSHA IC-84/41 • USCG ↕

↻ 210 BAR (3050 PSI)

-40°C to +100°C
-40°F to +212°F

1A • Z
1R • 2pc

Typical application:

Low and medium pressure hydraulic systems with petroleum and water-based fluids

Construction equipment and agriculture equipment

Agency specifications: MSHA | USCG

Hose construction:	Inner tube: Nitrile	Reinforcement: One wire braid (-04 to -08) Two wire braid (-10 to -16)	Cover: Nitrile
---------------------------	-------------------------------	---	--------------------------

Operating temperature: -40°C to +100°C (-40°F to +212°F)

Qualified fittings/socket: Fittings: 1A series | 1R series (-04, -05, -06, -08) | 2-piece Winner
Sockets: 00110 (-04, -06, -08) • 03310 (-10, -12, -16) (pg 173)

PART #	SIZE DIMENSIONS				PRESSURE				BEND		WEIGHT	
	Hose I.D.		Hose O.D. (nominal)		Working Pressure		Min. Burst Pressure		Min. Bend Radius		Weight	
	mm	in	mm	in	bar	psi	bar	psi	mm	in	kg/m	lbs/ft
EC118-04	6,4	0.25	12,5	0.49	210,0	3,050	840,0	12,200	50,0	1.97	0,18	0.12
EC118-06	9,5	0.38	16,1	0.63	210,0	3,050	840,0	12,200	65,0	2.56	0,27	0.18
EC118-08	12,7	0.50	19,9	0.78	210,0	3,050	840,0	12,200	90,0	3.54	0,36	0.24
EC118-10**	15,9	0.62	24,6	0.97	210,0	3,050	840,0	12,200	100,0	3.94	0,69	0.46
EC118-12**	19,0	0.75	28,8	1.13	210,0	3,050	840,0	12,200	120,0	4.72	0,81	0.54
EC118-16**	25,4	1.00	37,1	1.46	210,0	3,050	840,0	12,200	150,0	5.91	1,21	0.81

** indicates two-wire braid

Core | Premium | **Standard** | Braided | Spiral | High-Temp | Low-Temp | Abrasion | Suction



Standard

EC415

Winner
four wire spiral hose

Meets: SAE 100R12 | EN 856 R12 | ISO 18752

Winner by Danfoss **EC415-08**

12.7 mm (0.50 in)
DN12

SAE 100R12 • EN 856 R12 • ISO 18752
MSHA IC-84/41 • USCG +

280 BAR (4050 PSI)

-40°C to +121°C
-40°F to +250°F

Half Bend

4S

Typical application:

Hydraulic system service with petroleum and water based fluids, for general industrial service.

Agency specifications:	MSHA USCG		
Hose construction:	Inner tube: Nitrile	Reinforcement: Four wire spiral	Cover: Nitrile
Operating temperature:	-40°C to +121°C (-40°F to +250°F)		
Qualified fittings:	4S series		

PART #	SIZE DIMENSIONS				PRESSURE				BEND		WEIGHT	
	Hose I.D.		Hose O.D. (nominal)		Working Pressure		Min. Burst Pressure		Min. Bend Radius		Weight	
	mm	in	mm	in	bar	psi	bar	psi	mm	in	kg/m	lbs/ft
EC415-06	9.5	0.38	20.3	0.80	280	4,050	1,120	16,200	63,0	2.48	0.60	0.40
EC415-08	12.7	0.50	23.8	0.94	280	4,050	1,120	16,200	90,0	3.54	0.74	0.50
EC415-10	15.9	0.62	27.7	1.09	280	4,050	1,120	16,200	100,0	3.94	1.03	0.69
EC415-12	19.0	0.75	30.7	1.21	280	4,050	1,120	16,200	120,0	4.72	1.16	0.78
EC415-16	25.4	1.00	38.0	1.50	280	4,050	1,120	16,200	150,0	5.91	1.76	1.18
EC415-20	31.8	1.25	47.0	1.85	210	3,050	840	12,200	210,0	8.27	2.46	1.65
EC415-24	38.1	1.50	53.5	2.11	207	3,000	827	12,000	250,0	9.84	2.87	1.92
EC415-32	50.8	2.00	66.7	2.63	207	3,000	827	12,000	320,0	12.60	4.03	2.70

Winner

Standard core hose EC420

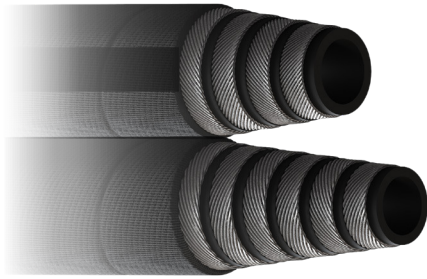

✓ Standard

EC420 | Winner
four & six wire spiral hose

Meets: SAE 100R13 | EN 856 R13 | ISO 18752

Winner by Danfoss **EC420-12**

19 mm (0.75 in)
DN19

SAE 100R13 • EN 856 R13 • ISO 18752
MSHA IC-84/41 • DNV • USCG +

↻ 350 BAR (5100 PSI)

🌡️ -40°C to +121°C
-40°F to +250°F

📐 Half Bend

🔗 4S

Typical application:

Suitable for use in hydraulic systems with high peak pressures and arduous operating conditions.

Agency specifications:

DNV | MSHA | USCG

Hose construction:

Inner tube:
Nitrile

Reinforcement:
Four wire spiral (-12, -16)
Six wire spiral (-20 to -32)

Cover:
Nitrile

Operating temperature:

-40°C to +121°C (-40°F to +250°F)

Qualified fittings:

4S series (12, -16) | 6S series (-20 to -32)

PART	SIZE DIMENSIONS				PRESSURE				BEND		WEIGHT	
	Hose I.D.		Hose O.D. (nominal)		Working Pressure		Min. Burst Pressure		Min. Bend Radius		Weight	
#	mm	in	mm	in	bar	psi	bar	psi	mm	in	kg/m	lbs/ft
EC420-12	19.0	0.75	32.1	1.27	350	5,100	1,400	20,400	120,0	4.72	1.54	1.03
EC420-16	25.4	1.00	38.7	1.53	350	5,100	1,400	20,400	150,0	5.91	2.01	1.35
EC420-20**	31.8	1.25	49.8	1.96	350	5,100	1,400	20,400	210,0	8.27	3.78	2.54
EC420-24**	38.1	1.50	57.3	2.26	350	5,100	1,400	20,400	250,0	9.84	4.73	3.18
EC420-32**	50.8	2.00	71.5	2.81	350	5,100	1,400	20,400	315,0	12.40	7.26	4.88

** 6 wire spiral

Core | Premium | **Standard** | Braided | **Spiral** | High-Temp | Low-Temp | Abrasion | Suction

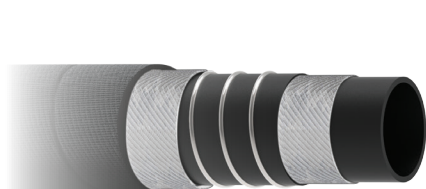

✓ Standard

WH004 | Winner suction & return hose

Exceeds: SAE 100R4 performance

Winner by Danfoss **WH004-12**

19 mm (0.75 in)
DN19

Exceeds SAE 100R4 PERFORMANCE
MSHA IC-261/5

21 BAR (305 PSI)

-40°C to +100°C
-40°F to +212°F

Half Bend

1A-Z
1G-2 pc

Typical application:

Suitable for use in suction applications for hydraulics, crude fuel, lubricating oils, gasoline, air, water and chemical transfer

Agency specifications:	MSHA		
Hose construction:	Inner tube: Oil-resistant NBR	Reinforcement: Textile with helical & anti-static wire	Cover: Nitrile
Operating temperature:	-40°C to +100°C (-40°F to +212°F)		
Qualified fittings/socket:	Fittings: • 1A and 1G: -12, -16, -20, -24 and -32 • 4T Optimum & Winner 2 pc series: -12 and -16 • Hose barb with band clamps: -12 thru -48 with a reduced operating pressure rating of 4 bar (60 psi) Socket: 03310 (pg 173)		

PART #	SIZE DIMENSIONS				PRESSURE				BEND		VACUUM*		WEIGHT	
	Hose I.D.		Hose O.D. (nominal)		Working Pressure		Min. Burst Pressure		Min. Bend Radius		Vacuum Service		Weight	
	mm	in	mm	in	bar	psi	bar	psi	mm	in	kPa	in/Hg	kg/m	lbs/ft
WH004-12	19.0	0.75	28,6	1.13	21,0	305	84	1220 †	40,0	1.57	94.8	28	0,54	0.36
WH004-16	25.4	1.00	35,2	1.39	17,0	245	68	980 †	45,0	1.77	94.8	28	0,68	0.46
WH004-20	31.8	1.25	42,0	1.65	14,0	205	56	820 †	60,0	2.36	94.8	28	0,85	0.57
WH004-24	38.1	1.50	49,2	1.94	10,5	150	42	600 †	65,0	2.56	94.8	28	1,20	0.81
WH004-32	50.8	2.00	62,0	2.44	7,0	100	28	400 †	100,0	3.94	94.8	28	1,53	1.03
WH004-40	63.5	2.50	75,5	2.97	4,0	60	16	240 †	140,0	5.51	94.8	28	2,05	1.38
WH004-48	76.2	3.00	88,0	3.46	4,0	60	16	240 †	180,0	7.09	94.8	28	2,62	1.76

† Maximum working pressure for band clamp type fittings is 3,4 bar [50 psi]

Aeroquip by Danfoss

Braided fittings

Braided series fittings























Hose to fitting chart

Match the fitting
to the braided

Premium core hose:     

Standard core hose: 

Global 1A fittings (pg.90 - 144)			Global OTC fittings (pg.90 - 144)		
For use with hose:		See hose page:	For use with hose:		See hose page:
GH681		39	FC619		72
FC839B		40	2661		73
GH194		41	WH004		83
GH781		42	Two-piece Winner (pg. 173 - 183)		
EC881		43	For use with hose:		See hose page:
FC735		44	EC115		78
GH195		45	EC215		79
GH120		46	EC118		80
FC639		54	WH004		83
GH663		55	Field attachable 1R fittings (pg 146 - 150)		
FC849		56	For use with hose:		See hose page:
FC849B		57	GH681		39
FC510		58	EC115		78
GH793		59	EC118		80
FC611		60	Field attachable 2R fittings (pg 151 - 155)		
FC693		61	For use with hose:		See hose page:
FC579		63	GH781		42
FC619		72	GH793		59
2661		73	EC215		79
EC115		78	Field attachable HI-PAC fittings (pg 158 - 169)		
EC215		79	For use with hose:		See Hose Page:
EC118		80	FC510		58
WH004		83			

Numbering system - hose fittings



4S12FJ12

Product group code: **4S**

End connection size: **12**

End connection code: **FJ** (Female JIC Swivel)

Hose size: **12**

Part numbering system

Part numbers collapse to the shortest possible number of digits:

It is assumed that a fitting has a straight configuration unless a code is added to designate otherwise.

e.g., 1AA8FJ8 has a straight configuration
1AA8FJA8 has a 45° elbow configuration

Dashes and unnecessary zeros are not used.

e.g., 1/4" is designated by "4" not "-4" or "04"
5/8" is designated by "10" not "-10"

Stainless steel fittings

A stainless steel version of many Danfoss fittings is available for use in the most demanding applications, such as those that are highly prone to corrosion or commonly exposed to corrosive chemicals. Stainless steel fittings use the Aeroquip fitting part numbering system with a material designation suffix of "C".

For more information, contact your support representative.

Aeroquip premium crimp fittings

- 1A** = 1A fitting part number
- 4S** = 4S fitting part number for four spiral hose
- 6S** = 6S fitting part number for six spiral hose
- 1R** = Field attachable fitting part number for 1 wire braided hose
- 2R** = Field attachable fitting part number for 2 wire braided hose
- 4T** = One piece fitting for Synflex 100R7, 100R8 and 100R18 Thermoplastic hose
- 1G** = OTC fitting part number
- 1W** = Internal skive spiral part number

If material is round stock, then this position collapses.

A = inch hex stock
(metric hex, this position collapses)

- BF = BSP Female Swivel (1 hex)
- BJ = Banjo
- BP = BSP Male Parallel
- BT = BSP Male Tapered
- CT = Cat Flange
- DK = 24 Male (light duty)
- DL = DKO Female Swivel (light duty)
- DS = DKO Female Swivel (heavy duty)
- EK = 24 Male (heavy duty)
- FC = Female Snap to Connect (STC)
- FH = Flange Code 62
- FJ = Female JIC Swivel
- FL = Flange Code 61
- FP = Female Pipe Rigid
- FR = Female ORS
- FS = Female SAE Swivel
- JF = JIS Female Swivel
- JM = BSP Female Swivel (2 hexes)
- KF = Komatsu Female Swivel
- KS = Komatsu Split Flange
- MB = Male Boss O-Ring
- MC = Male Snap to Connect (STC)
- MF = Male Inverted Flare
- MJ = Male JIC
- MP = Male Pipe
- MR = Male ORS
- PF = Female Pipe Swivel
- PS = Pipe Swivel

If nipple has a straight configuration, then this position collapses.

- A = 45° D = 22-1/2°
- B = 90°, standard or short drop
- C = 90°, long drop
- E = 67-1/2°
- F = 30°
- G = 60°

C = stainless steel, if fitting is zinc plated carbon steel (standard), this position collapses.

TZ = zinc nickel, if fitting is zinc plated carbon steel (standard), this position collapses.

*When ordering sizes 3, 4, 5, 6 and 8 the part number requires only single digits.

Hose installation and maintenance

Proper installation of the hose is essential to the proper operation and safe use of the hose and related equipment. Improper installation of the hose can result in serious injury or property damage caused by spraying fluids or flying projectiles. In order to avoid serious bodily injury or property damage resulting from improper installation of the hose, you should carefully review the information in this catalog regarding hose installation.

Some of the factors you must consider in installing the hose properly are:

- Changes in length
- Proper bend radius
- Protection from high temperature sources
- Elbows and adapters to relieve strain
- Rubbing or abrasion
- Twisting
- Improper hose movement

These factors and the other information in this catalog regarding hose installation should be considered by you before installing the hose. If you have any questions regarding proper hose installation, please contact Danfoss Technical Support.

Proper maintenance of the hose is essential to the safe use of the hose and related equipment. Hose should be stored in a dry place. Hose should also be visually inspected. Any hose that has a cut or gouge in the cover that exposes the reinforcement should be retired from service. Hoses should also be inspected for kinking or broken reinforcement. If the outside diameter of the hose is reduced by 20% at the spot where it is bent then the hose should be retired from service. Inadequate attention to maintenance of the hose can result in hose leakage, bursting, or other failure which can cause serious bodily injury or property damage from spraying fluids, flying projectiles, or other substances.

WARNING

Danfoss fitting tolerances are engineered to match approved Danfoss hose tolerances. The use of Danfoss fittings on hose supplied by other manufacturers and/or the use of Danfoss hoses with fittings supplied by other manufactures may result in the production of unreliable and unsafe hose assemblies and is neither recommended nor authorized by Danfoss or any of its affiliates or subsidiaries.

WARNING

Application considerations must be observed in selecting appropriate components for the application of these products contained herein. The failure to follow the recommendations set forth in this catalog may result in an unstable application which may result in serious personal injury or property damage.

Failure to follow these processes and product instructions and limitations could lead to premature hose assembly failures resulting in property damage, serious injury or death.

DANFOSS OR ANY OF ITS AFFILIATES OR SUBSIDIARIES SHALL NOT BE SUBJECT TO AND DISCLAIMS ANY OBLIGATIONS OR LIABILITIES (INCLUDING BUT NOT LIMITED TO ALL CONSEQUENTIAL, INCIDENTAL AND CONTINGENT DAMAGES) ARISING FROM TORT CLAIMS (INCLUDING WITHOUT LIMITATION NEGLIGENCE AND STRICT LIABILITY) OR OTHER THEORIES OF LAW WITH RESPECT TO ANY HOSE ASSEMBLIES NOT PRODUCED FROM GENUINE DANFOSS HOSE FITTINGS, HOSE AND DANFOSS APPROVED EQUIPMENT, AND IN CONFORMANCE WITH DANFOSS' PROCESS AND PRODUCT INSTRUCTIONS FOR EACH SPECIFIC HOSE ASSEMBLY.

Fitting series descriptions and part # examples

Fitting abbreviations			
ID	Description	Part # example	See page:
BF	JIS/BSPP female swivel	1A8BF8	112
BFA	JIS/BSPP female swivel, 45° elbow	1A8BFA8	114
BFB	JIS/BSPP female swivel 90° elbow	1A10BFB8	115
BJ	Banjo	1A12BJ6	139
BP	BSP male parallel, BSPP	1A8BP8	117
BT	BSP male tapered, BSPT	1A8BT8	116
DL	DKO female swivel, light duty	1A10DL6	118
DLA	DKO female swivel, light duty 45° elbow	1A12DLA8	119
DLB	DKO female swivel, light duty, 90° elbow	1A8DLB6	120
DK	24° male, light duty	1A10DK6	121
DS	DKO female swivel, heavy duty	1A8DS6	122
DSA	DKO female swivel, heavy duty, 45° elbow	1A10DSA6	123
DSB	DKO female swivel, heavy duty, 90° elbow	1A10DSB6	124
EK	24° male, heavy duty	1A8EK6	125
FC	Female snap to connect (STC)	1A8FC8	140
FH	SAE code 62 split flange	1A20FH20	135
FJ	Female JIC/SAE 37° swivel	1AA6FJ8	94-95
FJA	Female JIC/SAE 37° swivel 45° elbow	1AA8FJA8	96
FJB	Female JIC/SAE 37° swivel 90° elbow	1AA8FJB8	97-98
FJC	Female JIC/SAE 37° swivel 90° long drop elbow	1AA8FJC8	99
FL	SAE code 61 split flange	1A12FL12	128
FLA	SAE code 61 split flange 45° elbow	1A12FLA12	129
FLB	SAE code 61 split flange 90° elbow	1A12FLB12	130-131
FLD	SAE code 61 split flange 22 1/2° elbow	1A16FLD16	132
FLE	SAE code 61 split flange 67 1/2° elbow	1A20FLE20	133
FLG	SAE code 61 split flange 60° elbow	1A16FLG16	134
FR	Female ORS swivel	1AA8FR8	103
FRA	Female ORS swivel 45° elbow	1AA8FRA8	104
FRB	Female ORS swivel 90° short drop elbow	1AA8FRB8	105
FRC	Female ORS swivel 90° long drop elbow	1AA8FRC8	106
FS	Female SAE 45° swivel	1AA8FS8	101
JF	JIS female swivel	1A12JF10	126
JM	JIS/BSPP female swivel	1A8JM8	113
KF	Komatsu female swivel	1A8KF8	127
KS	Komatsu split flange	1A10KS10	136
KSA	Komatsu split flange 45° elbow	1A10KSA10	137
KSB	Komatsu split flange 90° elbow	1A10KSB10	138
MB	Male boss o-ring	1AA8MB8	102
MC	Male snap to connect (STC)	1A8MC8	141
MCA	Male snap to connect (STC) 45° elbow	1A6MCA6	142
MCB	Male snap to connect (STC) 90° elbow	1A8MCB8	143
MCC	Male snap to connect (STC) 90° long drop elbow	1A6MCC6	144
MF	Male SAE inverted flare swivel	1AA8MF8	109
MFA	Male SAE inverted flare swivel 45° elbow	1AA6MFA6	110
MFB	Male SAE inverted flare swivel 90° elbow	1AA6MFB6	111
MJ	Male JIC/SAE 37°	1AA8MJ8	100
MP	Male pipe	1AA8MP8	90-91
MR	Male ORS	1AA8MR8	107
PF	Female pipe swivel	1AA8PF8	92
PS	Male pipe swivel	1AA8PS8	93
SL	Male Staplok	1A8SL8	108

Braided series

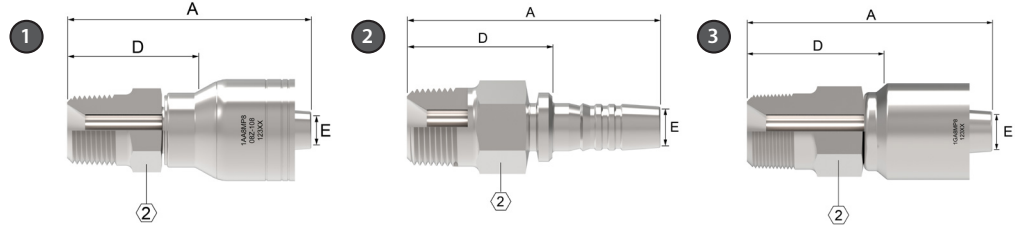

MP

Male pipe

PART			HOSE SIZE INFO		DIMENSIONS						
①	②	③	Thd.	Hose size	A		D		EØ		②
1A part #	Nipple part #	OTC part #			mm	in	mm	in	mm	in	in
—	1SA2MP3	—	1/8-27	-03	40,4	1.59	22,9	0.90	2,5	0.10	7/16
—	1SA4MP3	—	1/4-18	-03	41,4	1.62	23,6	0.93	2,5	0.10	9/16
1AA2MP4	1SA2MP4	1GA2MP4	1/8-27	-04	46,7	1.84	23,4	0.92	4,3	0.17	9/16
1AA4MP4	1SA4MP4	1GA4MP4	1/4-18	-04	52,3	2.06	29,0	1.14	4,3	0.17	9/16
1AA6MP4	1SA6MP4	1GA6MP4	3/8-18	-04	48,3	1.90	24,9	0.98	4,3	0.17	11/16
1AA4MP6	1SA4MP6	1GA4MP6	1/4-18	-06	51,4	2.02	30,1	1.18	6,7	0.26	11/16
1AA6MP6	1SA6MP6	1GA6MP6	3/8-18	-06	55,0	2.17	32,2	1.27	6,7	0.26	11/16
1AA8MP4	1SA8MP4	—	1/2-14	-04	51,3	2.02	31,2	1.23	4,3	0.17	7/8
1AA8MP6	1SA8MP6	1GA8MP6	1/2-14	-06	53,7	2.11	32,4	1.28	6,7	0.26	7/8
1AA4MP8	1SA4MP8	1GA4MP8	1/4-18	-08	58,5	2.30	31,3	1.23	7,7	0.30	13/16
1AA6MP8	1SA6MP8	1GA6MP8	3/8-18	-08	60,8	2.39	33,6	1.32	9,6	0.38	13/16
1AA8MP8	1SA8MP8	1GA8MP8	1/2-14	-08	71,0	2.80	40,6	1.60	9,6	0.38	7/8
1AA12MP8	1SA12MP8	1GA12MP8	3/4-14	-08	62,6	2.46	35,4	1.39	9,6	0.38	1-1/16
1AA6MP10	1SA6MP10	—	3/8-18	-10	63,2	2.49	33,8	1.33	10,7	0.42	15/16
1AA8MP10	1SA8MP10	1GA8MP10	1/2-14	-10	66,2	2.61	40,1	1.58	12,8	0.50	15/16
1AA12MP10	1SA12MP10	1GA12MP10	3/4-14	-10	61,7	2.43	35,6	1.40	12,8	0.50	1-1/16
1AA8MP12	1SA8MP12	1GA8MP12	1/2-14	-12	70,6	2.78	40,6	1.60	14,2	0.56	1-1/8
1AA12MP12	1SA12MP12	1GA12MP12	3/4-14	-12	72,1	2.84	41,9	1.65	15,5	0.61	1-1/8
1AA16MP12	1SA16MP12	1GA16MP12	1-11 1/2	-12	71,1	2.80	40,9	1.61	15,5	0.61	1-3/8

Braided series

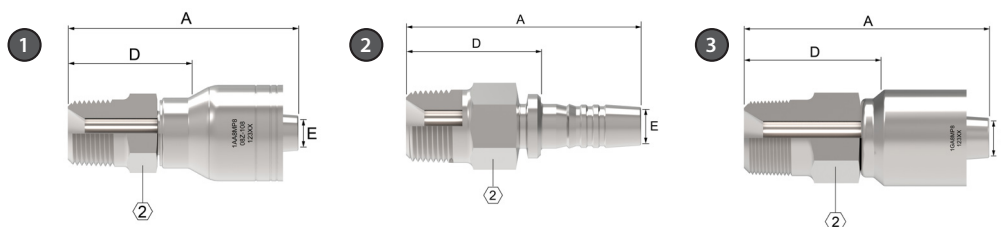

MP

Male pipe (cont.)

PART			HOSE SIZE INFO		DIMENSIONS						
1	2	3	Thd.	Hose size	A		D		E∅		2
1A part #	Nipple part #	OTC part #			mm	in	mm	in	mm	in	in
1AA12MP16	1SA12MP16	1GA12MP16	3/4-14	-16	76,7	3.02	42,4	1.67	19,3	0.76	1-3/8
1AA16MP16	1SA16MP16	1GA16MP16	1-11 1/2	-16	81,8	3.22	47,2	1.86	20,8	0.82	1-3/8
1AA20MP16	1SA20MP16	1GA20MP16	1 1/4-11 1/2	-16	78,2	3.08	43,7	1.72	20,8	0.82	1-11/16
1AA16MP20	1SA16MP20	1GA16MP20	1-11 1/2	-20	93,0	3.66	49,0	1.93	24,1	0.95	1-3/4
1AA20MP20	1SA20MP20	1GA20MP20	1 1/4-11 1/2	-20	84,9	3.34	45,5	1.79	26,6	1.05	1-13/16
1AA24MP24	1SA24MP24	1GA24MP24	1 1/2-11 1/2	-24	106,2	4.18	59,9	2.36	32,0	1.26	2
1AA32MP32	1SA32MP32	1GA32MP32	2-11 1/2	-32	116,6	4.59	66,3	2.61	44,5	1.75	2-1/2

Braided series

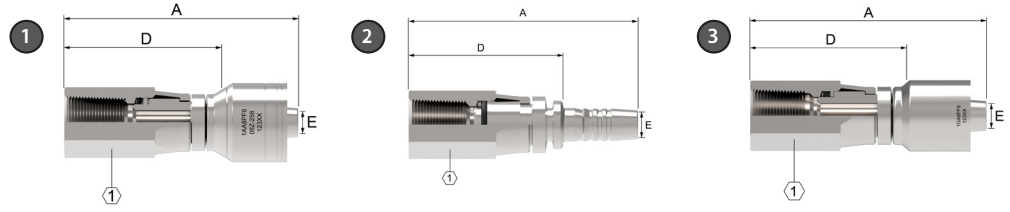

PF

Female Pipe Swivel

PART			HOSE SIZE INFO		DIMENSIONS						
①	②	③	Thd.	Hose size	A		D		EØ		①
1A part #	Nipple part #	OTC part #			mm	in	mm	in	mm	in	
1AA4PF4	1SA4PF4	1GA4PF4	1/4-18	-04	72,9	2.87	49,5	1.95	4,3	0.17	3/4
1AA6PF6	1SA6PF6	1GA6PF6	3/8-18	-06	75,4	2.97	50,0	1.97	6,6	0.26	7/8
1AA8PF8	1SA8PF8	1GA8PF8	1/2-14	-08	90,9	3.58	61,2	2.41	9,7	0.38	1-1/16
1AA12PF12	1SA12PF12	1GA12PF12	3/4-14	-12	92,2	3.63	62,0	2.44	15,5	0.61	1-3/8
1AA16PF16	1SA16PF16	—	1-11 1/2	-16	111,0	4.37	77,5	3.05	20,6	0.81	1-5/8

Braided series

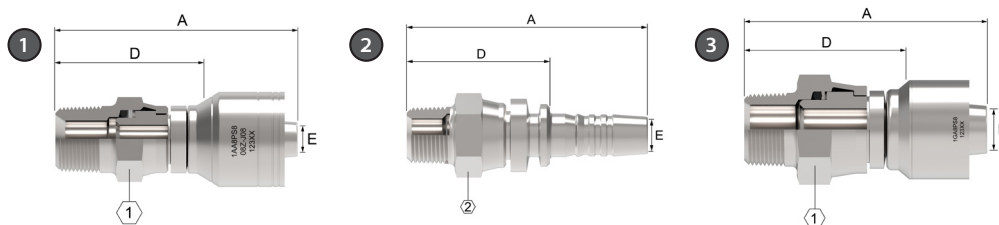

PS

Male Pipe Swivel

PART3			HOSE SIZE INFO		DIMENSIONS						
①	②	③	Thd.	Hose size	A		D		EØ		②
1A part #	Nipple part #	OTC part #			mm	in	mm	in	mm	in	in
—	1SA2PS3	—	1/8-27	-03	53,6	2.11	36,1	1.42	2,5	0.10	9/16
1AA4PS4	1SA4PS4	1GA4PS4	1/4-18	-04	64,5	2.54	41,4	1.62	4,3	0.17	3/4
1AA4PS6	1SA4PS6	—	1/4-18	-06	63,5	2.54	42,4	1.67	6,6	0.26	3/4
1AA6PS6	1SA6PS6	1GA6PS6	3/8-18	-06	67,6	2.66	42,4	1.67	6,6	0.26	7/8
1AA8PS6	1SA8PS6	1GA8PS6	1/2-14	-06	72,4	2.85	47,0	1.85	6,6	0.26	7/8
1AA6PS8	1SA6PS8	1GA6PS8	3/8-18	-08	73,2	2.88	43,4	1.71	9,7	0.38	7/8
1AA8PS8	1SA8PS8	1GA8PS8	1/2-14	-08	79,5	3.13	49,8	1.96	9,7	0.38	15/16
1AA12PS12	1SA12PS12	1GA12PS12	3/4-14	-12	82,3	3.24	52,1	2.05	15,5	0.61	1 3/8
1AA16PS16	1SA16PS16	1GA16PS16	1-11 1/2	-16	98,6	3.88	64,3	2.53	20,6	0.81	1 1/2

Braided series

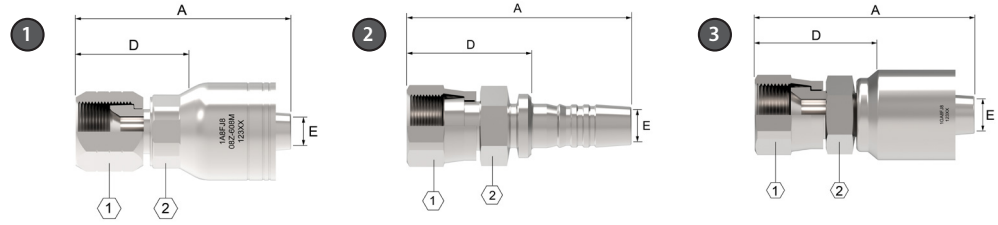

FJ

Female JIC/SAE 37° swivel

PART			HOSE SIZE INFO		DIMENSIONS							
①	②	③	Thd.	Hose size	A		D		EØ		①	②
1A part #	Nipple part #	OTC part #			mm	in	mm	in	mm	in	in	in
—	1SA3FJ3	—	3/8-24	-03	43,0	1.69	25,4	1.00	2,5	0.10	1/2	7/16
—	1SA4FJ3	—	7/16-20	-03	42,9	1.68	25,4	1.00	2,5	0.10	9/16	7/16
1AA3FJ4	1SA3FJ4	1GA3FJ4	3/8-24	-04	49,3	1.94	25,9	1.02	3,3	0.13	1/2	9/16
1AA4FJ4 †	1SA4FJ4	1GA4FJ4	7/16-20	-04	50,8	2.00	27,3	1.07	4,2	0.17	9/16	9/16
1AA5FJ4	1SA5FJ4	1GA5FJ4	1/2-20	-04	50,3	1.98	27,0	1.06	4,2	0.17	5/8	9/16
1AA6FJ4	1SA6FJ4	1GA6FJ4	11/16-18	-04	51,6	2.03	28,2	1.11	4,3	0.17	1 1/16	9/16
1AA5FJ5	1SA5FJ5	1GA5FJ5	1/2-20	-05	52,8	2.08	29,0	1.14	5,3	0.21	5/8	9/16
1AA6FJ5	1SA6FJ5	1GA6FJ5	11/16-18	-05	52,3	2.06	28,4	1.12	5,3	0.21	1 1/16	9/16
1AA4FJ6	1SA4FJ6	1GA4FJ6	7/16-20	-06	55,6	2.19	32,2	1.26	4,3	0.17	9/16	11/16
1AA5FJ6	1SA5FJ6	1GA5FJ6	1/2-20	-06	56,9	2.24	31,5	1.24	5,8	0.23	5/8	11/16
1AA6FJ6 †	1SA6FJ6	1GA6FJ6	11/16-18	-06	57,9	2.28	32,5	1.28	6,6	0.26	1 1/16	11/16
1AA8FJ6	1SA8FJ6	1GA8FJ6	3/4-16	-06	58,7	2.31	33,3	1.31	6,6	0.26	7/8	11/16
1AA10FJ6	1SA10FJ6	—	7/8-14	-06	61,5	2.42	36,2	1.42	6,6	0.26	1	11/16
1AA6FJ8	1SA6FJ8	—	9/16-18	-08	59,9	2.36	34,5	1.36	9,6	0.33	11/16	13/16
1AA8FJ8 †	1SA8FJ8	1GA8FJ8	3/4-16	-08	66,8	2.63	37,1	1.46	9,7	0.38	7/8	13/16
1AA10FJ8	1SA10FJ8	1GA10FJ8	7/8-14	-08	67,1	2.64	37,3	1.47	9,7	0.38	1	7/8
1AA12FJ8	1SA12FJ8	1GA12FJ8	1 1/16-12	-08	69,3	2.73	39,6	1.56	9,7	0.38	1 1/4	1
1AA16FJ8	1SA16FJ8	1GA16FJ8	1 5/16-12	-08	77,7	3.06	48,0	1.89	9,7	0.38	1 1/2	1 1/4
1AA8FJ10	1SA8FJ10	—	3/4-16	-10	67,3	2.65	38,1	1.50	9,9	0.39	7/8	15/16
1AA10FJ10 †	1SA10FJ10	1GA10FJ10	7/8-14	-10	70,4	2.77	41,1	1.62	12,7	0.50	1	15/16
1AA12FJ10	1SA12FJ10	1GA12FJ10	1 1/16-12	-10	69,1	2.72	39,9	1.57	12,7	0.50	1 1/4	1

† Swivel nuts are universal for both SAE 37° and SAE 45° connections.

Braided series

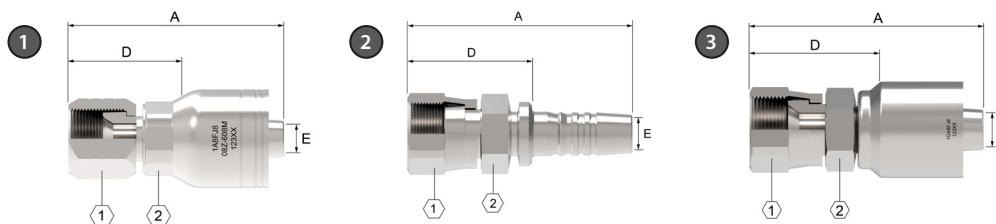

FJ

Female JIC/SAE 37° swivel (cont.)

PART			HOSE SIZE INFO		DIMENSIONS							
①	②	③	Thd.	Hose size	A		D		EØ		①	②
1A part #	Nipple part #	OTC part #			mm	in	mm	in	mm	in	in	in
1AA10FJ12	1SA10FJ12	1GA10FJ12	7/8-14	-12	71,4	2.81	41,4	1.63	12,2	0.48	1	1 1/8
1AA12FJ12	1SA12FJ12	1GA12FJ12	1 1/16-12	-12	72,1	2.84	41,9	1.65	15,5	0.61	1 1/4	1 1/8
1AA14FJ12	1SA14FJ12	1GA14FJ12	1 3/16-12	-12	72,1	2.84	42,6	1.68	15,5	0.61	1 3/8	1 1/8
1AA16FJ12	1SA16FJ12	1GA16FJ12	1 5/16-12	-12	73,9	2.91	43,7	1.72	15,5	0.61	1 1/2	1 1/4
1AA12FJ16	1SA12FJ16	1GA12FJ16	1 1/16-12	-16	80,0	3.15	45,7	1.80	15,5	0.61	1 1/4	1 3/8
1AA14FJ16	1SA14FJ16	—	1 3/16-12	-16	80,0	3.15	46,5	1.83	20,6	0.81	1 3/8	1 3/8
1AA16FJ16	1SA16FJ16	1GA16FJ16	1 5/16-12	-16	83,6	3.29	49,0	1.93	20,6	0.81	1 1/2	1 3/8
1AA20FJ16	1SA20FJ16	1GA20FJ16	1 5/8-12	-16	80,5	3.17	46,0	1.81	20,6	0.81	2	—
1AA16FJ20	1SA16FJ20	1GA16FJ20	1 5/16-12	-20	87,9	3.46	43,9	1.73	21,6	0.85	1 1/2	—
1AA20FJ20	1SA20FJ20	1GA20FJ20	1 5/8-12	-20	91,7	3.61	47,8	1.88	26,7	1.05	2	—
—	1SA24FJ20	—	1 7/8-12	-20	95,5	3.76	51,6	2.03	26,7	1.05	2 1/4	—
1AA24FJ24	1SA24FJ24	1GA24FJ24	1 7/8-12	-24	99,1	3.90	52,6	2.07	32,0	1.26	2 1/4	—
1AA24FJ32	1SA24FJ32	1GA24FJ32	1 7/8-12	-32	103,9	4.09	53,8	2.12	33,3	1.31	2 1/4	—
1AA32FJ32	1SA32FJ32	1GA32FJ32	2 1/2-12	-32	110,2	4.34	60,7	2.39	44,5	1.75	2 7/8	—

Braided series

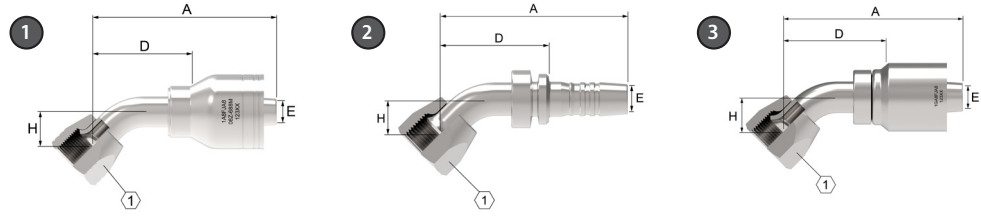

FJA

Female JIC/SAE 37° swivel 45° elbow

PART			HOSE SIZE INFO		DIMENSIONS								
①	②	③	Thd.	Hose size	A		D		EØ		H		①
1A part #	Nipple part #	OTC part #			mm	in	mm	in	mm	in	mm	in	in
1AA4FJA4 †	1SA4FJA4 †	1GA4FJA4 †	7/16-20	-04	45,1	1.78	24,6	0.97	4,2	0.17	8,4	0.33	9/16
1AA5FJA4 †	1SA5FJA4 †	1GA5FJA4 †	1/2-20	-04	51,8	2.04	28,4	1.12	4,3	0.17	9,4	0.37	5/8
1AA6FJA4	1SA6FJA4	1GA6FJA4	9/16-18	-04	53,1	2.09	29,7	1.17	4,3	0.17	9,9	0.39	11/16
1AA4FJA6	1SA4FJA6	—	7/16-20	-06	44,5	1.75	23,4	0.92	4,1	0.16	8,4	0.33	9/16
1AA6FJA6	1SA6FJA6	1GA6FJA6	9/16-18	-06	58,7	2.31	33,3	1.31	6,1	0.24	9,9	0.39	11/16
1AA8FJA6 †	1SA8FJA6 †	1GA8FJA6 †	3/4-16	-06	67,3	2.65	42,2	1.66	6,6	0.26	14,0	0.55	7/8
1AA8FJA8 †	1SA8FJA8 †	1GA8FJA8 †	3/4-16	-08	71,6	2.82	41,9	1.65	9,4	0.37	14,0	0.55	7/8
1AA10FJA8 †	1SA10FJA8 †	1GA10FJA8 †	7/8-14	-08	77,0	3.03	47,2	1.86	9,7	0.38	15,0	0.59	1
1AA10FJA10 †	1SA10FJA10 †	1GA10FJA10 †	7/8-14	-10	75,2	2.96	45,4	1.79	11,7	0.46	16,0	0.63	1
1AA12FJA10	1SA12FJA10	1GA12FJA10	1 1/16-12	-10	85,9	3.38	56,4	2.22	12,7	0.50	19,8	0.78	1 1/4
1AA12FJA12	1SA12FJA12	1GA12FJA12	1 1/16-12	-12	87,1	3.43	56,9	2.24	14,7	0.58	19,8	0.78	1 1/4
1AA16FJA12	1SA16FJA12	—	1 5/16-12	-16	95,0	3.74	60,7	2.39	19,3	0.76	27,2	1.07	1 1/2
1AA20FJA16	1SA20FJA16	1GA20FJA16	1 5/8-12	-16	101,6	4.00	67,3	2.65	20,6	0.81	31,0	1.22	2
1AA16FJA16	1SA16FJA16	1GA16FJA16	1 5/16-12	-16	95,0	3.74	76,4	3.01	20,6	0.81	27,1	1.07	1 1/2
1AA20FJA20	1SA20FJA20	1GA20FJA20	1 5/8-12	-20	112,8	4.44	68,8	2.71	25,7	1.01	31,0	1.22	2

† Swivel nuts are universal for both SAE 37° and SAE 45° connections.

Braided series

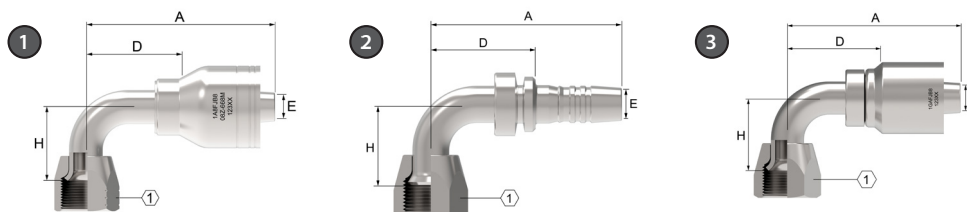

FJB

Female JIC/SAE 37° swivel 90° elbow

PART			HOSE SIZE INFO		DIMENSIONS								
①	②	③	Thd.	Hose size	A		D		EØ		H		①
1A part #	Nipple part #	OTC part #			mm	in	mm	in	mm	in	mm	in	in
—	1SA4FJB3†	—	7/16-20	-03	40,6	1.60	23,1	0.91	2,5	0.10	17,3	0.68	9/16
1AA4FJB4†	1SA4FJB4†	1GA4FJB4†	7/16-20	-04	46,7	1.84	23,3	0.92	4,2	0.17	17,3	0.68	9/16
1AA5FJB4†	1SA5FJB4†	1GA5FJB4†	1/2-20	-04	48,8	1.92	25,4	1.00	4,3	0.17	19,3	0.76	5/8
1AA6FJB4	1SA6FJB4	1GA6FJB4	9/16-18	-04	50,8	2.00	25,1	0.99	4,2	0.17	22,9	0.90	11/16
—	1SA5FJB5†	—	1/2-20	-05	49,5	1.95	25,7	1.01	4,6	0.18	19,3	0.76	5/8
1AA4FJB6	—	—	7/16-20	-06	50,2	1.98	24,9	0.98	3,9	0.15	17,3	0.68	9/16
1AA6FJB6	1SA6FJB6	1GA6FJB6	9/16-18	-06	56,1	2.21	31,0	1.22	6,1	0.24	21,3	0.84	11/16
1AA8FJB6†	1SA8FJB6†	1GA8FJB6†	3/4-16	-06	61,5	2.42	36,1	1.42	6,6	0.26	27,7	1.09	7/8
1AA6FJB8	1SA6FJB8	1GA6FJB8	9/16-18	-08	61,7	2.43	32,0	1.26	6,1	0.24	21,3	0.84	11/16
1AA8FJB8†	1SA8FJB8†	1GA8FJB8†	3/4-16	-08	65,8	2.59	36,1	1.42	9,4	0.37	27,7	1.09	7/8
1AA10FJB8†	1SA10FJB8†	1GA10FJB8†	7/8-14	-08	70,6	2.78	41,0	1.61	9,7	0.38	30,2	1.19	1
1AA10FJB10†	1SA10FJB10†	1GA10FJB10†	7/8-14	-10	70,2	2.76	39,3	1.55	11,7	0.46	31,2	1.23	1
1AA10FJB12	1SA10FJB12	—	7/8-14	-12	65,3	2.57	39,6	1.56	11,7	0.46	30,2	1.19	1
—	1SA12FJB8	—	1 1/16-12	-08	86,1	3.39	56,4	2.22	9,7	0.38	45,7	1.80	1 1/4
1AA12FJB10	1SA12FJB10	1GA12FJB10	1 1/16-12	-10	84,1	3.31	54,9	2.16	12,7	0.50	45,7	1.80	1 1/4
1AA20FJB16	1SA20FJB16	—	1 5/8-12	-16	95,8	3.77	62,2	2.45	20,8	0.82	69,9	2.75	2

† Swivel nuts are universal for both SAE 37° and SAE 45° connections.

Braided series

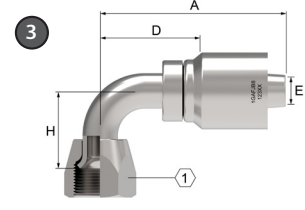
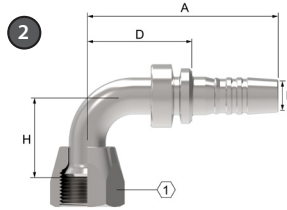
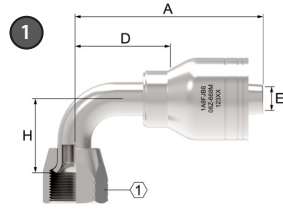

FJB

Female JIC/SAE 37° swivel 90° elbow (cont.)

PART			HOSE SIZE INFO		DIMENSIONS								
①	②	③	Thd.	Hose size	A		D		EØ		H		①
1A part #	Nipple part #	OTC part #			mm	in	mm	in	mm	in	mm	in	in
1AA12FJB12	1SA12FJB12	1GA12FJB12	1 1/16-12	-12	85,4	3.36	55,1	2.17	17,4	0.58	45,7	1.82	1 1/4
1AA16FJB12	1SA16FJB12	1GA16FJB12	1 5/16-12	-12	85,6	3.37	55,4	2.18	15,5	0.61	60,7	2.39	1 1/2
1AA16FJB16	1SA16FJB16	1GA16FJB16	1 5/16-12	-16	90,4	3.56	72,9	2.87	20,6	0.81	60,7	2.39	1 1/2
—	1SA16FJB20	—	1 5/16-12	-20	101,6	4.00	57,7	2.27	19,3	0.76	60,7	2.39	1 1/2
1AA20FJB20	1SA20FJB20	1GA20FJB20	1 5/8-12	-20	108,0	4.25	64,0	2.52	25,7	1.01	69,9	2.75	2
1AA24FJB24	1SA24FJB24	—	1 7/8-12	-24	117,6	4.63	71,4	2.81	32,0	1.26	80,5	3.17	2 1/4

† Swivel nuts are universal for both SAE 37° and SAE 45° connections.

Braided series

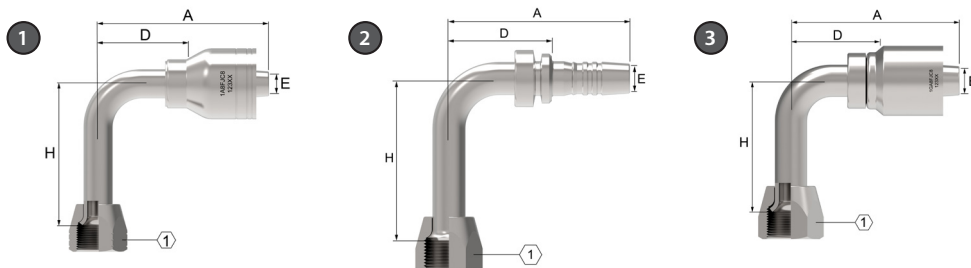

FJC

Female JIC/SAE 37° swivel 90° long drop elbow

PART			HOSE SIZE INFO		DIMENSIONS								
① 1A part #	② Nipple part #	③ OTC part #	Thd.	Hose size	A		D		EØ		H		① in
					mm	in	mm	in	mm	in	mm	in	in
1AA4FJC4 †	1SA4FJC4 †	1GA4FJC4 †	7/16-20	-04	46,7	1.84	23,3	0.92	4,2	0.17	45,7	1.80	9/16
1AA5FJC4 †	1SA5FJC4 †	1GA5FJC4 †	1/2-20	-04	48,8	1.92	25,4	1.00	4,3	0.17	45,7	1.80	5/8
—	1SA6FJC4	—	9/16-18	-04	45,5	1.79	22,1	0.87	4,3	0.17	55,4	2.18	11/16
1AA4FJC6	1SA4FJC6	—	7/16-20	-06	46,0	1.81	24,9	0.98	4,3	0.17	45,7	1.80	9/16
1AA6FJC6	1SA6FJC6	1GA6FJC6	9/16-18	-06	56,4	2.22	31,2	1.23	6,1	0.24	55,4	2.18	11/16
1AA8FJC6 †	1SA8FJC6 †	—	3/4-16	-06	64,5	2.54	39,1	1.54	6,6	0.26	61,7	2.43	7/8
1AA8FJC8 †	1SA8FJC8 †	1GA8FJC8 †	3/4-16	-08	68,8	2.71	39,1	1.54	9,4	0.37	62,2	2.45	7/8
1AA10FJC8 †	1SA10FJC8 †	1GA10FJC8 †	7/8-14	-08	70,6	2.78	40,9	1.61	9,7	0.38	65,3	2.57	1
1AA10FJC10	1SA10FJC10	—	7/8-14	-10	68,6	2.70	39,1	1.54	11,7	0.46	65,3	2.57	1
1AA12FJC12**	1SA12FJC12	1GA12FJC12	1 1/16-12	-12	85,3	3.36	55,2	2.17	14,7	0.58	94,0	3.76	1 1/4
1AA16FJC16***	1SA16FJC16	1GA16FJC16	1 5/16-12	-16	90,4	3.56	72,9	2.87	20,6	0.81	116,4	4.58	1 1/2
1AA20FJC20	1SA20FJC20	1GA20FJC20	1 5/8-12	-20	108,0	4.25	64,0	2.52	25,7	1.01	140,5	5.53	2

† Swivel nuts are universal for both SAE 37° and SAE 45° connections.

** The 90° long drop tube elbow configuration meets a 3.5:1 burst, based on 4000psi operating pressure.

***The 90° long drop tube elbow configuration meets a 3.7:1 burst, based on 3000psi operating pressure.

Braided series

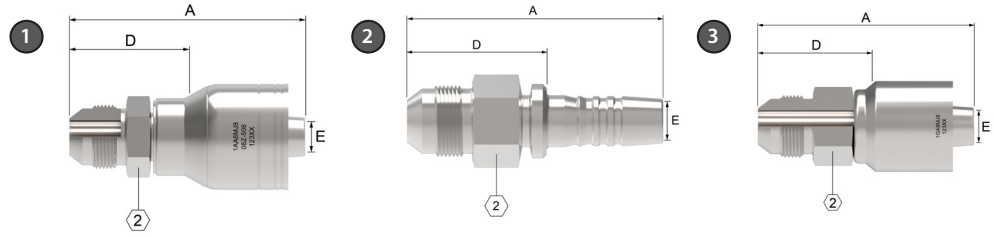

MJ

Male JIC/SAE 37°

PART			HOSE SIZE INFO		DIMENSIONS						
① 1A part #	② Nipple part #	③ OTC part #	Thd.	Hose size	A		D		EØ		②
					mm	in	mm	in	mm	in	in
1AA4MJ4	1SA4MJ4	1GA4MJ4	7/16-20	-04	50,8	2.00	27,2	1.07	4,3	0.17	9/16
1AA5MJ4	1SA5MJ4	1GA5MJ4	1/2-20	-04	46,7	1.84	23,4	0.92	4,3	0.17	9/16
1AA6MJ4	1SA6MJ4	1GA6MJ4	9/16-18	-04	47,0	1.85	23,6	0.93	4,3	0.17	5/8
—	1SA5MJ5	—	1/2-20	-05	52,6	2.07	28,4	1.12	5,3	0.21	9/16
1AA6MJ5	1SA6MJ5	1GA6MJ5	9/16-18	-05	47,8	1.88	23,9	0.94	5,3	0.21	15/8
1AA6MJ6	1SA6MJ6	1GA6MJ6	9/16-18	-06	53,7	2.12	31,0	1.22	6,7	0.26	11/16
1AA8MJ6	1SA8MJ6	1GA8MJ6	3/4-16	-06	53,4	2.10	28,1	1.11	6,7	0.26	13/16
1AA8MJ8	1SA8MJ8	1GA8MJ8	3/4-16	-08	65,8	2.59	35,5	1.40	9,6	0.38	13/16
1AA10MJ6	1SA10MJ6	—	7/8-14	-06	53,3	2.10	30,7	1.21	6,6	0.26	15/16
1AA10MJ8	1SA10MJ8	1GA10MJ8	7/8-14	-08	59,1	2.33	31,9	1.26	9,6	0.38	15/16
1AA12MJ8	1SA12MJ8	1GA12MJ8	1 1/16-12	-08	63,4	2.50	36,2	1.43	9,7	0.38	1-1/8
1AA8MJ10	1SA8MJ10	—	3/4-16	-10	61,7	2.43	35,8	1.41	12,7	0.50	15/16
1AA10MJ10	1SA10MJ10	1GA10MJ10	7/8-14	-10	69,4	2.73	40,5	1.59	12,3	0.48	15/16
1AA12MJ10	1SA12MJ10	1GA12MJ10	1 1/16-12	-10	62,4	2.46	36,4	1.43	12,8	0.50	1-1/8
1AA10MJ12	1SA10MJ12	1GA10MJ12	7/8-14	-12	70,6	2.78	40,4	1.59	12,2	0.48	1-1/8
1AA12MJ12	1SA12MJ12	1GA12MJ12	1 1/16-12	-12	74,7	2.94	43,9	1.73	15,5	0.61	1-1/8
1AA14MJ12	1SA14MJ12	1GA14MJ12	1 3/16-12	-12	69,3	2.73	39,1	1.54	15,5	0.61	1-1/4
1AA16MJ12	1SA16MJ12	1GA16MJ12	1 5/16-12	-12	69,9	2.75	39,6	1.56	15,5	0.61	1-3/8
1AA14MJ16	1SA14MJ16	—	1 3/16-12	-16	79,0	3.11	45,7	1.80	18,3	0.72	1-3/8
1AA16MJ16	1SA16MJ16	1GA16MJ16	1 5/16-12	-16	82,6	3.25	47,5	1.88	20,8	0.82	1-3/8
1AA20MJ16	1SA20MJ16	—	1 5/8-12	-16	77,0	3.03	43,4	1.71	20,6	0.81	1-11/16
1AA20MJ20	1SA20MJ20	1GA20MJ20	1 5/8-12	-20	98,8	3.89	54,9	2.16	26,7	1.05	1-3/4
1AA24MJ24	1SA24MJ24	1GA24MJ24	1 7/8-12	-24	109,5	4.31	63,2	2.49	32,0	1.26	2
1AA32MJ32	1SA32MJ32	1GA32MJ32	2 1/2-12	-32	124,2	4.89	73,9	2.91	44,5	1.75	2-5/8

Braided series

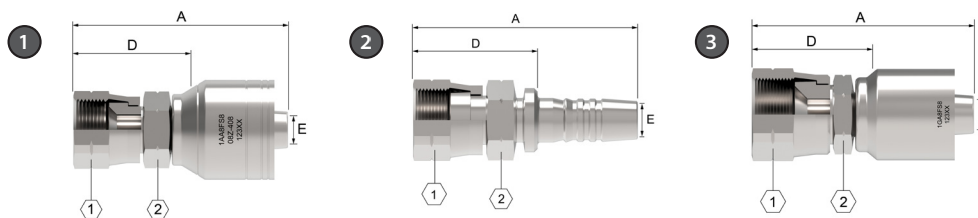

FS

Female SAE 45° swivel

PART			HOSE SIZE INFO		DIMENSIONS							
1	2	3	Thd.	Hose size	A		D		EØ		1	2
1A part #	Nipple part #	OTC part #			mm	in	mm	in	mm	in	in	in
1AA4FS4	1SA4FS4	1GA4FS4	7/16-20	-04	50,8	2.00	27,2	1.07	4,3	0.17	9/16	9/16
1AA5FS4	1SA5FS4	1GA5FS4	1/2-20	-04	50,3	1.98	26,9	1.06	4,3	0.17	5/8	9/16
1AA4FS6	1SA4FS6	1GA4FS6	7/16-20	-06	51,6	2.03	30,3	1.19	4,9	0.19	9/16	11/16
1AA6FS6	1SA6FS6	1GA6FS6	5/8-18	-06	54,7	2.15	33,4	1.31	6,7	0.26	3/4	11/16
1AA8FS6	1SA8FS6	1GA8FS6	3/4-16	-06	58,7	2.31	33,3	1.31	6,6	0.26	7/8	11/16
1AA8FS8	1SA8FS8	1GA8FS8	3/4-16	-08	66,8	2.63	37,1	1.46	9,7	0.38	7/8	13/16
1AA10FS8	1SA10FS8	1GA10FS8	7/8-14	-08	64,6	2.54	37,4	1.47	9,6	0.38	1	13/16
—	1SA10FS10	1GA10FS10	7/8-14	-10	70,4	2.77	40,9	1.61	12,7	0.50	1	15/16
1AA12FS10	1SA12FS10	—	1 1/16-14	-10	69,1	2.72	39,9	1.57	12,7	0.50	1 1/4	1-1/16
1AA12FS12	1SA12FS12	1GA12FS12	1 1/16-14	-12	72,1	2.84	41,9	1.65	15,5	0.61	1 1/4	1-1/8

Braided series

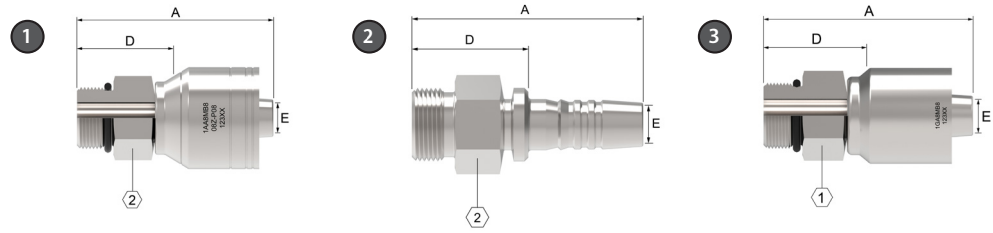

MB

Male boss o-ring

PART			HOSE SIZE INFO		DIMENSIONS						
①	② †	③	Thd.	Hose size	A		D		EØ		②
1A part #	Nipple part #	OTC part #			mm	in	mm	in	mm	in	in
1AA4MB4	1SA4MB4	1GA4MB4	7/16-20	-04	46,7	1.84	23,4	0.92	4,3	0.17	9/16
1AA5MB4	1SA5MB4	1GA5MB4	1/2-20	-04	46,7	1.84	23,4	0.92	4,3	0.17	5/8
1AA6MB4	1SA6MB4	1GA6MB4	9/16-18	-04	45,2	1.78	21,8	0.86	4,3	0.17	11/16
1AA6MB6	1SA6MB6	1GA6MB6	9/16-18	-06	50,8	1.99	25,4	1.00	6,6	0.26	11/16
1AA8MB6	1SA8MB6	1GA8MB6	3/4-16	-06	50,0	1.97	24,9	0.98	6,6	0.26	7/8
1AA10MB6	1SA10MB6	—	7/8-14	-06	47,8	1.88	26,7	1.05	6,6	0.26	1
1AA8MB8	1SA8MB8	1GA8MB8	3/4-16	-08	59,9	2.36	30,2	1.19	9,7	0.38	7/8
1AA10MB8	1SA10MB8	1GA10MB8	7/8-14	-08	57,4	2.26	27,7	1.09	9,7	0.38	1
1AA12MB8	1SA12MB8	1GA12MB8	1 1/16-12	-08	60,7	2.39	31,0	1.22	9,7	0.38	1 1/4
1AA8MB10	1SA8MB10	—	3/4-16	-10	56,1	2.21	30,2	1.19	12,7	0.50	15/16
1AA10MB10	1SA10MB10	1GA10MB10	7/8-14	-10	59,4	2.34	33,5	1.32	12,7	0.50	1
1AA10MB12	1SA10MB12	—	7/8-14	-12	64,3	2.53	37,1	1.46	12,2	0.48	1 1/8
1AA12MB10	1SA12MB10	1GA12MB10	1 1/16-12	-10	60,7	2.39	31,2	1.23	12,7	0.50	1 1/4
1AA12MB12	1SA12MB12	1GA12MB12	1 1/16-12	-12	62,0	2.44	31,8	1.25	15,5	0.61	1 1/4
1AA16MB12	1SA16MB12	1GA16MB12	1 5/16-12	-12	65,0	2.56	34,8	1.37	15,5	0.61	1 1/2
1AA16MB16	1SA16MB16	1GA16MB16	1 5/16-12	-16	69,6	2.74	35,3	1.39	20,8	0.82	1 1/2
1AA20MB20	1SA20MB20	1GA20MB20	1 5/8-12	-20	92,2	3.63	48,3	1.90	26,7	1.05	1 7/8
1AA24MB24	1SA24MB24	1GA24MB24	1 7/8-12	-24	92,2	3.63	46,0	1.81	32,0	1.26	2 1/8

† Nipples do not include O-ring. See pages 245-247 for O-Rings.

Braided series

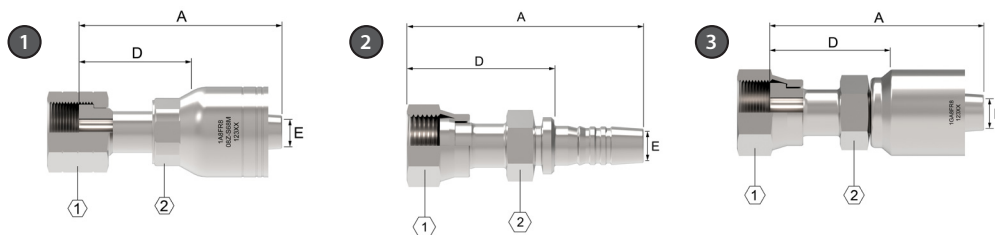

FR

Female ORS swivel

PART			HOSE SIZE INFO		DIMENSIONS							
1	2	3	Thd.	Hose size	A		D		EØ		1	2
1A part #	Nipple part #	OTC part #			mm	in	mm	in	mm	in	in	in
1AA4FR4	1SA4FR4	1GA4FR4	9/16-18	-04	49,5	1.95	26,1	1.03	4,2	0.17	11/16	9/16
1AA6FR4	1SA6FR4	1GA6FR4	11/16-16	-04	51,8	2.04	28,4	1.12	4,2	0.17	13/16	9/16
1AA8FR4	1SA8FR4	—	13/16-16	-04	52,3	2.06	32,5	1.28	4,1	0.16	13/16	15/16
1AA4FR6	1SA4FR6	1GA4FR6	9/16-18	-06	54,4	2.14	29,2	1.15	4,3	0.17	11/16	11/16
1AA6FR6	1SA6FR6	1GA6FR6	11/16-16	-06	56,6	2.23	31,5	1.24	6,6	0.26	13/16	11/16
1AA8FR6	1SA8FR6	1GA8FR6	13/16-16	-06	58,9	2.32	33,5	1.32	6,6	0.26	15/16	13/16
1AA6FR8	1SA6FR8	1GA6FR8	11/16-16	-08	63,8	2.51	34,0	1.34	6,6	0.26	13/16	7/8
1AA8FR8	1SA8FR8	1GA8FR8	13/16-16	-08	67,8	2.67	38,1	1.50	9,7	0.38	15/16	7/8
1AA10FR8	1SA10FR8	1GA10FR8	1-14	-08	67,1	2.64	37,3	1.47	9,7	0.38	1 1/8	15/16
1AA12FR8	1SA12FR8	1GA12FR8	1 3/16-16	-08	71,1	2.80	41,4	1.63	9,7	0.38	1 3/8	1 1/8
1AA8FR10	1SA8FR10	1GA8FR10	13/16-16	-10	67,8	2.67	38,4	1.51	9,7	0.38	15/16	15/16
1AA10FR10	1SA10FR10	1GA10FR10	1-14	-10	70,1	2.76	40,9	1.61	12,2	0.48	1 1/8	15/16
1AA12FR10	1SA12FR10	1GA12FR10	1 3/16-12	-10	70,9	2.79	41,4	1.63	12,7	0.50	1 3/8	1 1/8
1AA10FR12	1SA10FR12	1GA10FR12	1-14	-12	71,4	2.81	41,4	1.62	12,2	0.48	1 1/8	1 1/8
1AA12FR12	1SA12FR12	1GA12FR12	1 3/16-12	-12	73,9	2.91	43,7	1.72	15,5	0.61	1 3/8	1 1/8
1AA16FR12	1SA16FR12	1GA16FR12	1 7/16-12	-12	75,7	2.98	45,5	1.79	15,5	0.61	1 5/8	1 3/8
1AA12FR16	1SA12FR16	1GA12FR16	1 3/16-12	-16	81,8	3.22	47,2	1.86	15,5	0.61	1 3/8	1 3/8
1AA16FR16	1SA16FR16	1GA16FR16	1 7/16-12	-16	83,6	3.29	49,3	1.94	20,6	0.81	1 5/8	1 3/8
1AA20FR16	1SA20FR16	1GA20FR16	1 11/16-12	-16	82,6	3.25	48,3	1.90	20,6	0.81	1 7/8	1 5/8
1AA20FR20	1SA20FR20	1GA20FR20	1 11/16-12	-20	103,4	4.07	59,2	2.33	25,9	1.02	1 7/8	1 3/4
1AA24FR20	1SA24FR20	1GA24FR20	2-12	-20	98,6	3.88	54,6	2.15	26,7	1.05	2 1/4	1 13/16
1AA24FR24	1SA24FR24	1GA24FR24	2-12	-24	102,1	4.02	55,6	2.19	32,0	1.26	2 1/4	2

Braided series

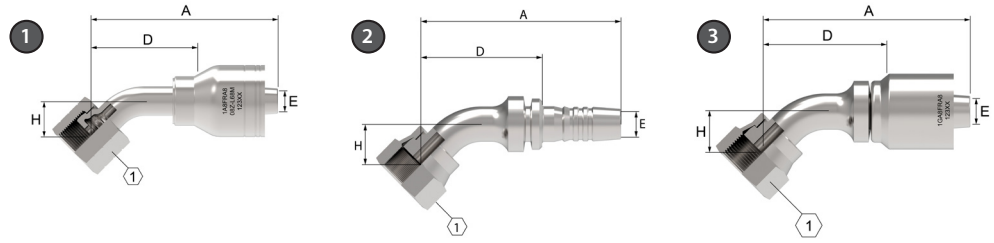

FRA

Female ORS swivel 45° elbow

PART			HOSE SIZE INFO		DIMENSIONS								
1	2	3	Thd.	Hose size	A		D		EØ		H		1
1A part #	Nipple part #	OTC part #			mm	in	mm	in	mm	in	mm	in	in
1AA4FRA4	1SA4FRA4	1GA4FRA4	9/16-18	-04	53,8	2.12	30,4	1.20	4,2	0.17	10,4	0.41	11/16
1AA6FRA4	1SA6FRA4	1GA6FRA4	11/16-16	-04	58,4	2.30	35,1	1.38	4,3	0.17	10,9	0.43	13/16
1AA4FRA6	1SA4FRA6	1GA4FRA6	9/16-18	-06	58,4	2.30	33,0	1.30	4,3	0.17	10,4	0.41	11/16
1AA6FRA6	1SA6FRA6	1GA6FRA6	11/16-16	-06	61,7	2.43	36,3	1.43	6,6	0.26	10,9	0.43	13/16
1AA8FRA6	1SA8FRA6	1GA8FRA6	13/16-16	-06	69,6	2.74	44,2	1.74	6,6	0.26	15,0	0.59	15/16
1AA6FRA8	1SA6FRA8	—	11/16-16	-08	67,3	2.65	37,6	1.48	6,6	0.26	10,9	0.43	13/16
1AA8FRA8	1SA8FRA8	1GA8FRA8	13/16-16	-08	74,5	2.93	45,5	1.79	9,1	0.36	15,0	0.59	15/16
1AA10FRA8	1SA10FRA8	1GA10FRA8	1-14	-08	80,8	3.18	51,1	2.01	9,7	0.38	16,5	0.65	1 1/8
1AA12FRA8	1SA12FRA8	1GA12FRA8	1 3/16-12	-08	89,2	3.51	59,4	2.34	9,7	0.38	21,1	0.83	1 3/8
1AA10FRA10	1SA10FRA10	1GA10FRA10	1-14	-10	77,5	3.05	51,3	2.02	11,4	0.45	16,5	0.65	1 1/8
1AA12FRA10	1SA12FRA10	—	1 3/16-12	-10	89,4	3.52	59,9	2.36	12,7	0.50	21,1	0.83	1 3/8
1AA10FRA12	1SA10FRA12	—	1-14	-12	78,5	3.09	51,8	2.04	11,4	0.45	16,5	0.65	1 1/8
1AA12FRA12	1SA12FRA12	1GA12FRA12	1 3/16-12	-12	90,7	3.57	60,5	2.38	14,0	0.55	21,1	0.83	1 3/8
1AA16FRA12	1SA16FRA12	1GA16FRA12	1 7/16-12	-12	102,6	4.04	72,4	2.85	15,5	0.61	23,9	0.94	1 5/8
1AA12FRA16	1SA12FRA16	—	1 3/16-12	-16	94,5	3.72	60,9	2.40	14,0	0.55	21,1	0.83	1 3/8
1AA16FRA16	1SA16FRA16	1GA16FRA16	1 7/16-12	-16	107,4	4.23	73,1	2.88	20,6	0.81	23,9	0.94	1 5/8
1AA20FRA16	1SA20FRA16	—	1 11/16-12	-16	117,3	4.62	83,8	3.30	20,7	0.81	25,4	1.00	1 7/8
1AA20FRA20	1SA20FRA20	1GA20FRA20	1 11/16-12	-20	129,5	5.10	85,6	3.37	25,7	1.02	25,4	1.00	1 7/8
1AA24FRA20	1SA24FRA20	1GA24FRA20	2-12	-20	139,4	5.49	95,5	3.76	25,7	1.01	27,2	1.07	2 1/4
1AA24FRA24	1SA24FRA24	1GA24FRA24	2-12	-24	115,3	4.54	68,8	2.71	32,0	1.26	27,2	1.07	2 1/4

Braided series

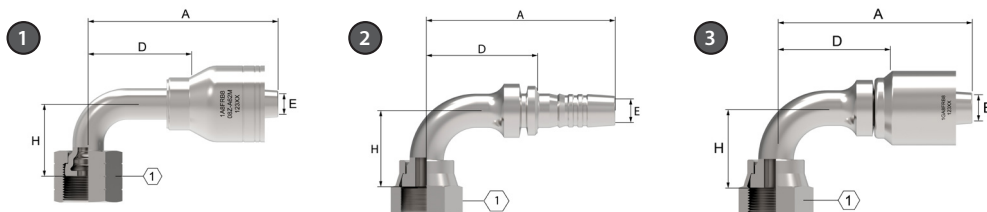

FRB

Female ORS swivel 90° short drop elbow

PART			HOSE SIZE INFO		DIMENSIONS								
1	2	3	Thd.	Hose size	A		D		EØ				1
1A part #	Nipple part #	OTC part #			mm	in	mm	in	mm	in	mm	in	mm
1AA4FRB4	1SA4FRB4	1GA4FRB4	9/16-18	-04	53,1	2.09	23,3	0.92	4,2	0.17	20,8	0.82	11/16
1AA6FRB4	1SA6FRB4	1GA6FRB4	11/16-16	-04	56,4	2.22	25,2	0.99	4,2	0.17	22,9	0.90	13/16
—	1SA8FRB4	—	13/16-16	-04	60,2	2.37	36,8	1.45	4,3	0.17	30,2	1.19	15/16
1AA4FRB6	1SA4FRB6	1GA4FRB6	9/16-18	-06	56,1	2.21	30,7	1.21	4,3	0.17	20,8	0.82	11/16
1AA6FRB6	1SA6FRB6	1GA6FRB6	11/16-16	-06	59,4	2.34	34,0	1.34	6,6	0.26	22,9	0.90	13/16
1AA8FRB6	1SA8FRB6	1GA8FRB6	13/16-16	-06	66,5	2.62	41,4	1.62	6,6	0.26	29,2	1.15	15/16
1AA6FRB8	1SA6FRB8	1GA6FRB8	11/16-16	-08	65,0	2.56	35,3	1.39	6,6	0.26	22,9	0.90	13/16
1AA8FRB8	1SA8FRB8	1GA8FRB8	13/16-16	-08	72,1	2.84	42,4	1.67	9,1	0.36	29,2	1.15	15/16
1AA10FRB8	1SA10FRB8	1GA10FRB8	1-14	-08	78,0	3.07	48,5	1.91	9,7	0.38	32,3	1.27	1 1/8
1AA12FRB8	1SA12FRB8	1GA12FRB8	1 3/16-12	-08	87,6	3.45	57,9	2.28	9,7	0.38	47,8	1.88	1 3/8
1AA10FRB10	1SA10FRB10	1GA10FRB10	1-14	-10	78,0	3.07	48,5	1.91	11,4	0.45	32,3	1.27	1 1/8
1AA12FRB10	1SA12FRB10	1GA12FRB10	1 3/16-12	-10	87,4	3.44	58,2	2.29	12,7	0.50	47,8	1.88	1 3/8
1AA10FRB12	1SA10FRB12	1GA10FRB12	1-14	-12	79,0	3.11	49,0	1.93	11,4	0.45	32,3	1.27	1 1/8
1AA12FRB12	1SA12FRB12	1GA12FRB12	1 3/16-12	-12	88,6	3.49	58,4	2.30	14,0	0.55	47,8	1.88	1 3/8
1AA16FRB12	1SA16FRB12	1GA16FRB12	1 7/16-12	-12	102,6	4.04	72,4	2.85	15,5	0.61	32,3	2.21	1 5/8
1AA16FRB16	1SA16FRB16	1GA16FRB16	1 7/16-12	-16	107,2	4.22	72,9	2.87	20,6	0.81	47,8	2.21	1 5/8
1AA20FRB16	1SA20FRB16	1GA20FRB16	1 11/16-12	-16	123,2	4.85	89,0	3.50	20,6	0.81	56,1	2.51	1 7/8
1AA20FRB20	1SA20FRB20	1GA20FRB20	1 11/16-12	-20	134,6	5.30	90,7	3.57	25,9	1.02	56,1	2.51	1 7/8
1AA24FRB20	1SV24FRB20	—	2-12	-20	109,7	4.32	70,4	2.77	26,6	1.05	63,8	2.70	2 1/4
1AA24FRB24	1SA24FRB24	1GA24FRB24	2-12	-24	117,6	4.63	71,4	2.81	32,0	1.26	63,8	2.70	2 1/4

Braided series

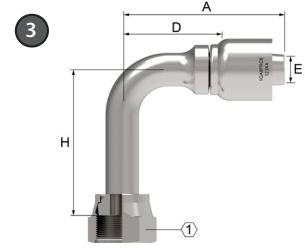
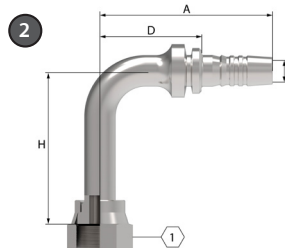
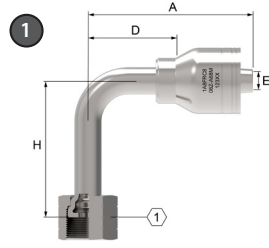

FRC

Female ORS swivel 90° long drop elbow

PART			HOSE SIZE INFO		DIMENSIONS								
1	2	3	Thd.	Hose size	A		D		EØ		H		1
1A part #	Nipple part #	OTC part #			mm	in	mm	in	mm	in	mm	in	in
1AA4FRC4	1SA4FRC4	1GA4FRC4	9/16-18	-04	53,1	2.09	23,3	0.92	4,2	0.17	46,0	1.81	11/16
1AA6FRC4	1SA6FRC4	1GA6FRC4	11/16-16	-04	56,4	2.22	33,0	1.30	4,3	0.17	54,1	2.13	13/16
1AA8FRC4	1SA8FRC4	1GA8FRC4	13/16-16	-04	65,8	2.59	42,4	1.67	4,3	0.17	64,8	2.55	15/16
1AA6FRC6	1SA6FRC6	1GA6FRC6	11/16-16	-06	59,4	2.34	34,0	1.34	6,1	0.24	54,1	2.13	13/16
1AA8FRC6	1SA8FRC6	1GA8FRC6	13/16-16	-06	68,8	2.71	43,4	1.71	6,6	0.26	64,8	2.55	15/16
1AA8FRC8	1SA8FRC8	1GA8FRC8	13/16-16	-08	72,9	2.87	43,2	1.70	9,4	0.37	64,8	2.55	15/16
1AA10FRC8	1SA10FRC8	1GA10FRC8	1-14	-08	78,0	3.07	48,5	1.91	9,7	0.38	70,1	2.76	1 1/8
1AA10FRC10	1SA10FRC10	1GA10FRC10	1-14	-10	78,0	3.07	48,5	1.91	11,7	0.46	70,1	2.76	1 1/8
1AA12FRC12**	1SA12FRC12	1GA12FRC12	1 3/16-12	-12	88,4	3.48	58,4	2.30	14,2	0.56	96,0	3.78	1 3/8
1AA16FRC12	1SA16FRC12	—	1 7/16-12	-12	102,6	4.04	72,9	2.87	20,6	0.81	114,3	4.50	1 5/8
1AA16FRC16***	1SA16FRC16	1GA16FRC16	1 7/16-12	-16	107,2	4.22	72,6	2.86	19,8	0.78	114,3	4.50	1 5/8
1AA20FRC20	1SA20FRC20	1GA20FRC20	1 11/16-12	-20	134,6	5.30	90,7	3.57	25,7	1.01	129,3	5.09	1 7/8
1AA24FRC20	1SV24FRC20	—	2-12	-20	109,7	4.32	70,4	2.77	26,7	1.05	140,7	5.54	2 1/4
1AA24FRC24	1SA24FRC24	1GA24FRC24	2-12	-24	117,6	4.63	71,4	2.81	32,0	1.26	140,7	5.54	2 1/4

**The 90° long drop tube elbow configuration meets a 3.5:1 burst, based on 4000psi operating pressure.

***The 90° long drop tube elbow configuration meets a 3.7:1 burst, based on 3000psi operating pressure.

Braided series

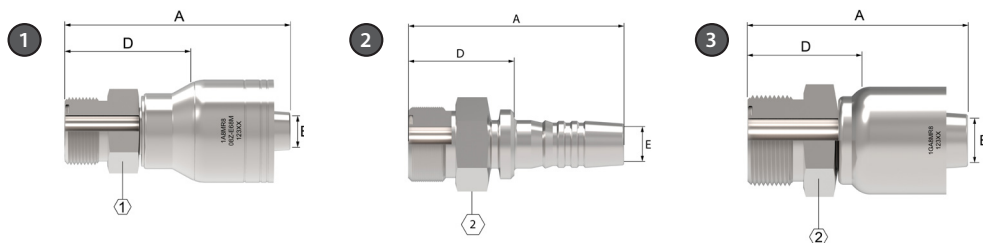

MR

Male ORS†

PART			HOSE SIZE INFO		DIMENSIONS						
1	2	3	Thd.	Hose size	A		D		EØ		2
1A part #	Nipple part #	OTC part #			mm	in	mm	in	mm	in	in
1AA4MR4	1SA4MR4	1GA4MR4	9/16-18	-04	45,2	1.78	21,8	0.86	4,3	0.17	5/8
1AA6MR6	1SA6MR6	1GA6MR6	11/16-16	-06	50,5	1.99	29,5	1.16	6,6	0.26	3/4
1AA8MR6	1SA8MR6	1GA8MR6	13/16-16	-06	49,5	1.95	24,1	0.95	6,6	0.26	7/8
1AA8MR8	1SA8MR8	1GA8MR8	13/16-16	-08	58,4	2.30	34,0	1.34	9,7	0.38	7/8
1AA10MR8	1SA10MR8	—	1-14	-08	55,1	2.17	29,7	1.17	9,7	0.38	1 1/16
1AA12MR8	1SA12MR8	—	1 3/16-12	-08	57,7	2.27	32,3	1.27	9,7	0.38	1 1/4
1AA10MR10	1SA10MR10	—	1-14	-10	57,4	2.26	36,6	1.44	12,2	0.48	1 1/16
1AA12MR10	1SA12MR10	—	1 3/16-12	-10	57,4	2.26	31,5	1.24	12,7	0.50	1 1/4
1AA12MR12	1SA12MR12	1GA12MR12	1 3/16-12	-12	66,8	2.63	38,9	1.53	15,5	0.61	1 1/4
1AA16MR12	1SA16MR12	1GA16MR12	1 7/16-12	-12	64,3	2.53	34,0	1.34	15,5	0.61	1 1/2
—	1SA16MR16	—	1 7/16-12	-16	76,2	3.00	41,7	1.64	20,6	0.81	1 1/2
1AA16MR16	1SA16MR16	—	1 7/16-12	-16	75,2	2.96	42,9	1.69	20,7	0.81	1 1/2
1AA20MR20	1SV20MR20	—	1 11/16-12	-20	85,1	3.35	45,7	1.80	26,2	1.03	1 3/4

† Does not include O-ring. See pages 245-247 for O-Rings.

Braided series

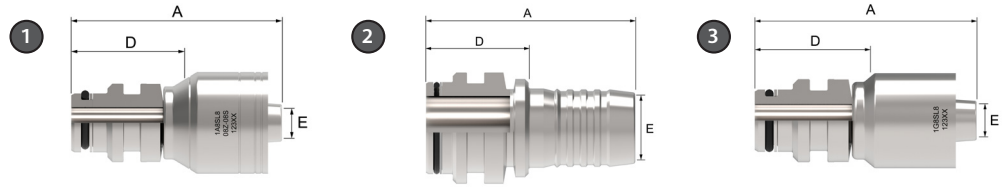

SL

Male Staplok

PART			HOSE SIZE INFO	DIMENSIONS					
1	2	3	Hose size	A		D		EØ	
1A part #	Nipple part #	OTC part #		mm	in	mm	in	mm	in
1A4SL4	1S4SL4	1G4SL4	-04	55,4	2.18	32,0	1.26	4,3	0.17
1A6SL6	1S6SL6	1G6SL6	-06	58,4	2.30	33,0	1.30	6,6	0.26
1A8SL6	1S8SL6	1G8SL6	-06	58,4	2.30	33,0	1.30	6,6	0.26
1A8SL8	1S8SL8	1G8SL8	-08	64,0	2.52	34,3	1.35	9,7	0.38
1A12SL12	1S12SL12	1G12SL12	-12	65,0	2.56	34,8	1.37	15,5	0.61
1A16SL16	1S16SL16	1G16SL16	-16	74,9	2.95	40,6	1.60	20,6	0.81
1A20SL20	1S20SL20	1G20SL20	-20	86,4	3.40	42,4	1.67	26,7	1.05
1A32SL32	1S32SL32	1G32SL32	-32	98,3	3.87	48,0	1.89	44,5	1.75

Braided series

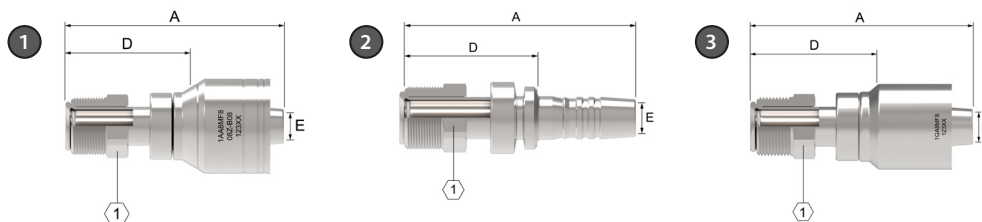

MF

Male SAE inverted flare swivel

PART			HOSE SIZE INFO		DIMENSIONS						
1	2	3	Thd.	Hose size	A		D		EØ		1
1A part #	Nipple part #	OTC part #			mm	in	mm	in	mm	in	in
—	1SA4MF3	—	7/16-24	-03	54,6	2.15	37,1	1.46	2,5	0.10	7/16
1AA3MF4	1SA3MF4	—	3/8-24	-04	61,5	2.42	38,1	1.50	2,5	0.10	3/8
1AA4MF4	1SA4MF4	1GA4MF4	7/16-24	-04	60,7	2.39	37,1	1.46	4,3	0.17	7/16
1AA5MF4	1SA5MF4	—	1/2-20	-04	60,7	2.39	37,1	1.46	4,3	0.17	1/2
1AA5MF6	1SA5MF6	1GA5MF6	1/2-20	-06	66,0	2.60	40,9	1.61	6,1	0.24	1/2
1AA4MF6	1SA4MF6	—	7/16-24	-06	64,3	2.53	38,9	1.53	4,3	0.17	7/16
1AA6MF6	1SA6MF6	1GA6MF6	5/8-18	-06	66,0	2.60	40,9	1.61	6,6	0.26	5/8
1AA7MF6	1SA7MF6	—	11/16-18	-06	62,2	2.45	40,6	1.60	6,6	0.26	11/16
1AA8MF8	1SA8MF8	1GA8MF8	3/4-18	-08	70,9	2.79	41,4	1.62	9,7	0.38	3/4
1AA10MF8	1SA10MF8	—	7/8-18	-08	74,7	2.94	49,0	1.93	9,7	0.38	7/8

Braided series

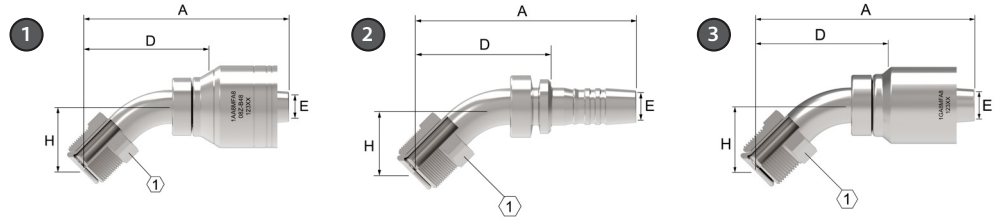

MFA

Male SAE inverted flare swivel 45° elbow

PART			HOSE SIZE INFO		DIMENSIONS								
①	②	③	Thd.	Hose size	A		D		EØ		H		①
1A part #	Nipple part #	OTC part #			mm	in	mm	in	mm	in	mm	in	in
1AA3MFA4	1SA3MFA4	—	3/8-24	-04	69,9	2.75	49,8	1.96	2,5	0.10	17,5	0.69	3/8
1AA4MFA4	1SA4MFA4	1GA4MFA4	7/16-24	-04	67,8	2.67	44,5	1.75	4,3	0.17	24,4	0.96	7/16
1AA5MFA4	1SA5MFA4	—	1/2-20	-04	64,5	2.54	44,5	1.75	4,3	0.17	24,4	0.96	1/2
1AA4MFA6	1SA4MFA6	—	7/16-24	-06	71,4	2.81	46,0	1.81	4,3	0.17	24,4	0.96	7/16
1AA5MFA6	1SA5MFA6	1GA5MFA6	1/2-20	-06	73,2	2.88	48,0	1.89	6,1	0.24	24,4	0.96	1/2
1AA6MFA6	1SA6MFA6	1GA6MFA6	5/8-18	-06	73,2	2.88	48,0	1.89	6,6	0.26	24,4	0.96	5/8
1AA7MFA6	1SA7MFA6	—	11/16-18	-06	69,3	2.73	48,0	1.89	6,6	0.26	24,4	0.96	11/16
1AA8MFA8	1SA8MFA8	1GA8MFA8	3/4-18	-08	78,0	3.07	48,3	1.90	9,7	0.38	23,6	0.93	3/4

Braided series

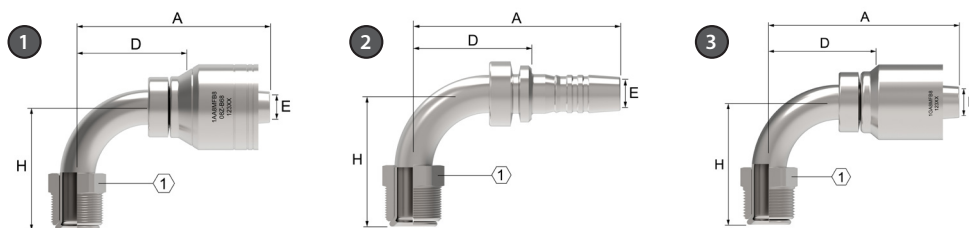

MFB

Male SAE inverted flare swivel 90° elbow

PART			HOSE SIZE INFO		DIMENSIONS								
①	②	③	Thd.	Hose size	A		D		EØ		H		①
1A part #	Nipple part #	OTC part #			mm	in	mm	in	mm	in	mm	in	in
1AA4MFB4	1SA4MFB4	1GA4MFB4	7/16-24	-04	58,2	2.29	34,8	1.37	4,3	0.17	42,3	1.69	7/16
1AA5MFB4	1SA5MFB4	—	1/2-20	-04	58,2	2.29	34,8	1.37	4,3	0.17	43,9	1.73	1/2
1AA4MFB6	1SA4MFB6	—	7/16-24	-06	61,7	2.43	36,6	1.44	4,3	0.17	42,3	1.69	7/16
1AA5MFB6	1SA5MFB6	1GA5MFB6	1/2-20	-06	63,8	2.51	38,4	1.51	6,1	0.24	43,9	1.73	1/2
1AA6MFB6	1SA6MFB6	1SA6MFB6	5/8-18	-06	63,8	2.51	38,4	1.51	6,6	0.26	43,9	1.73	5/8
1AA7MFB6	1SA7MFB6	—	11/16-18	-06	62,0	2.44	40,9	1.61	6,6	0.26	43,9	1.73	11/16
1AA8MFB8	1SA8MFB8	1GA8MFB8	3/4-18	-08	69,3	2.73	39,6	1.56	9,7	0.38	44,5	1.75	3/4

Braided series

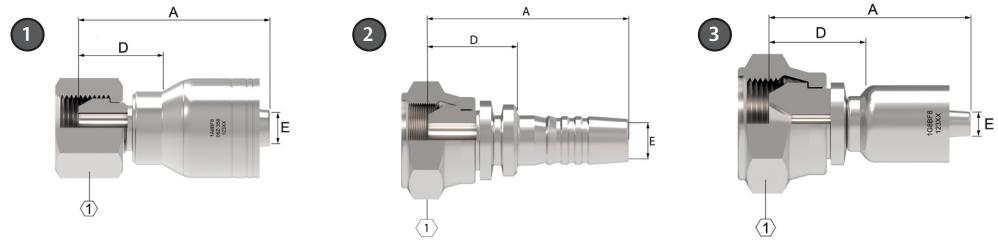

BF

JIS/BSPP female swivel†

PART			HOSE SIZE INFO		DIMENSIONS							
①	②	③	Thd.	Hose size	A		D		EØ		①	
1A part #	Nipple part #	OTC part #			mm	in	mm	in	mm	in	mm	in
1A4BF4	1S4BF4	1G4BF4	G 1/4	-04	42,3	1.66	18,9	0.74	4,2	0.16	19,0	0.75
1A6BF4	1S6BF4	—	G 3/8*	-04	45,5	1.79	22,1	0.87	4,3	0.17	22,0	0.87
1A6BF6	1S6BF6	1G6BF6	G 3/8	-06	46,4	1.83	21,1	0.83	6,7	0.26	22,0	0.87
1A8BF6	1S8BF6	1G8BF6	G 1/2	-06	47,9	1.88	22,6	0.89	6,7	0.26	27,0	1.06
1A8BF8	1S8BF8	1G8BF8	G 1/2	-08	53,5	2.11	23,8	0.94	9,6	0.38	27,0	1.06
1A10BF8	1S10BF8	—	G 5/8*	-08	56,4	2.22	26,7	1.05	9,6	0.38	30,0	1.18
1A10BF10	1S10BF10	1G10BF10	G 5/8	-10	54,1	2.13	24,7	0.97	12,8	0.50	30,0	1.18
1A12BF12	1S12BF12	1G12BF12	G 3/4	-12	55,5	2.18	25,3	1.00	15,5	0.61	32,0	1.26
1A16BF16	1S16BF16	1G16BF16	G 1	-16	62,0	2.44	27,6	1.09	20,7	0.81	41,0	1.61
1A20BF20	1S20BF20	1G20BF20	G 1 1/4	-20	73,6	2.90	29,6	1.16	26,6	1.05	50,0	1.97
—	1S24BF24	1G24BF24	G 1 1/2	-24	80,0	3.15	33,7	1.33	32,0	1.26	55,0	2.16
—	1S32BF32	1G32BF32	G 2	-32	85,4	3.36	35,2	1.38	44,4	1.75	70,0	2.75

† The JIS parallel thread and the BSPP connection are interchangeable. G as part of thread size is ISO Designation for parallel thread.

Braided series

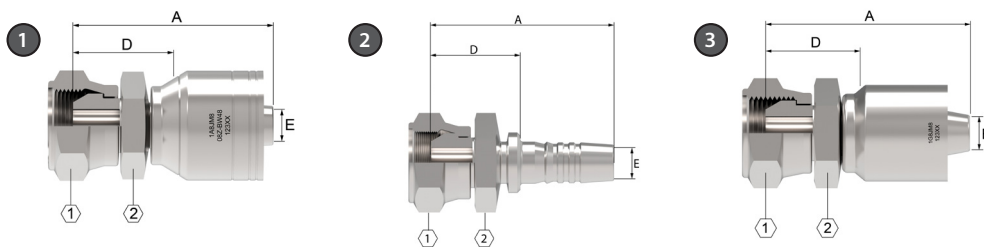

JM

JIS/BSPP female swivel†

PART			HOSE SIZE INFO		DIMENSIONS									
1	2	3	Thd.	Hose size	A		D		EØ		1		2	
1A part #	Nipple part #	OTC part #			mm	in	mm	in	mm	in	mm	in	in	in
1A4JM4	1S4JM4	1G4JM4	G 1/4	-04	47,0	1.85	23,6	0.93	4,2	0.16	19,0	0.75	19,0	0.75
1A6JM6	1S6JM6	1G6JM6	G 3/8	-06	51,0	2.01	25,7	1.01	6,7	0.26	22,0	0.87	22,0	0.87
1A8JM8	1S8JM8	1G8JM8	G 1/2	-08	58,0	2.28	28,3	1.11	9,6	0.38	27,0	1.06	27,0	1.06
1A12JM12	1S12JM12	1G12JM12	G 3/4	-12	62,0	2.44	31,8	1.25	15,5	0.61	32,0	1.26	36,0	1.42
1A16JM16	1S16JM16	1G16JM16	G 1	-16	69,0	2.72	34,6	1.36	20,7	0.81	41,0	1.61	41,0	1.61
1A20JM20	1S20JM20	1G20JM20	G 1 1/4	-20	80,2	3.16	36,2	1.42	26,6	1.05	50,0	1.97	46,0	1.81

†The JIS parallel thread and the BSPP connection are interchangeable. G as part of thread size is ISO Designation for parallel thread.

Braided series

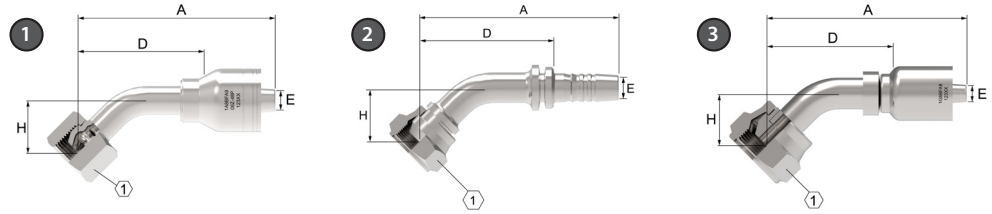

BFA

JIS/BSPP female swivel, 45° elbow[†]

PART			HOSE SIZE INFO		DIMENSIONS									
1	2	3	Thd.	Hose size	A		D		EØ		H		1	
1A part #	Nipple part #	OTC part #			mm	in	mm	in	mm	in	mm	in	mm	in
1A4BFA4	1S4BFA4	1G4BFA4	G 1/4	-04	65,3	2.57	41,9	1.65	4,2	0.16	16,5	0.65	19,0	0.75
1A6BFA6	1S6BFA6	1G6BFA6	G 3/8	-06	73,8	2.90	48,5	1.91	6,7	0.26	19,0	0.75	22,0	0.87
1A8BFA8	1S8BFA8	1G8BFA8	G 1/2	-08	91,5	3.60	61,8	2.43	9,6	0.38	24,8	0.98	27,0	1.06
1A10BFA10	1S10BFA10	1G10BFA10	G 5/8	-10	100,4	3.95	71,0	2.79	12,8	0.50	27,4	1.08	30,0	1.18
1A12BFA12	1S12BFA12	1G12BFA12	G 3/4	-12	108,8	4.28	78,6	3.09	15,5	0.61	29,4	1.16	32,0	1.26
1A16BFA16	1S16BFA16	1G16BFA16	G 1	-16	126,8	4.99	92,4	3.09	20,7	0.81	33,2	1.31	41,0	1.61
1A20BFA20	1S20BFA20	1G20BFA20	G 1 1/4	-20	153,6	6.05	109,6	4.31	26,6	1.05	37,2	1.46	50,0	1.97

[†]The JIS parallel thread and the BSPP connection are interchangeable. G as part of thread size is ISO Designation for parallel thread.

Braided series

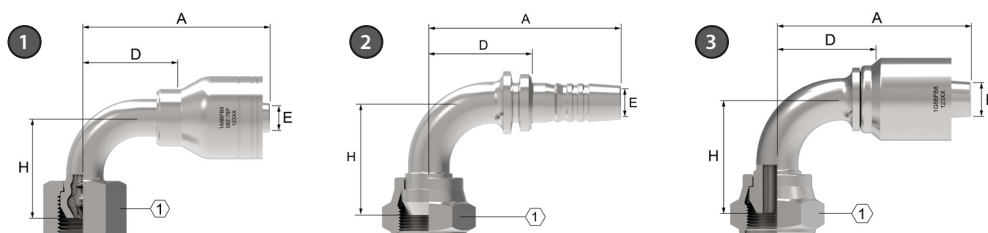

BFB

JIS/BSPP female swivel 90° elbow†

PART			HOSE SIZE INFO		DIMENSIONS									
1	2	3	Thd.	Hose size	A		D		EØ		H		1	
1A part #	Nipple part #	OTC part #			mm	in	mm	in	mm	in	mm	in	mm	in
1A4BFB4	1S4BFB4	1G4BFB4	G 1/4	-04	45,8	1.80	22,4	0.88	4,2	0.16	24,8	0.98	17,0	0.67
1A6BFB6	1S6BFB6	1G6BFB6	G 3/8	-06	58,9	2.32	33,6	1.32	6,7	0.26	35,0	1.38	22,0	0.87
1A8BFB6	1S8BFB6	1G8BFB6	G 1/2	-06	75,7	2.98	50,4	1.98	6,7	0.26	47,8	1.88	27,0	1.06
1A8BFB8	1S8BFB8	1G8BFB8	G 1/2	-08	65,5	2.58	35,8	1.41	9,6	0.38	37,5	1.48	27,0	1.06
1A10BFB8	1S10BFB8	—	G 5/8*	-08	90,7	3.57	61,0	2.40	9,6	0.38	56,3	2.22	27,0	1.06
1A10BFB10	1S10BFB10	1G10BFB10	G 5/8	-10	90,6	3.57	61,2	1.41	12,8	0.50	56,3	2.22	27,0	1.06
1A12BFB12	1S12BFB12	1G12BFB12	G 3/4	-12	82,2	3.24	52,0	2.05	15,5	0.61	47,5	1.87	32,0	1.26
1A16BFB16	1S16BFB16	1G16BFB16	G 1	-16	118,2	4.65	83,8	3.30	20,7	0.81	71,5	2.81	41,0	1.61
1A20BFB20	1S20BFB20	1G20BFB20	G 1 1/4	-20	146,2	5.75	102,2	4.02	26,6	1.05	82,5	3.25	50,0	1.97

†The JIS parallel thread and the BSPP connection are interchangeable. G as part of thread size is ISO Designation for parallel thread.

Braided series

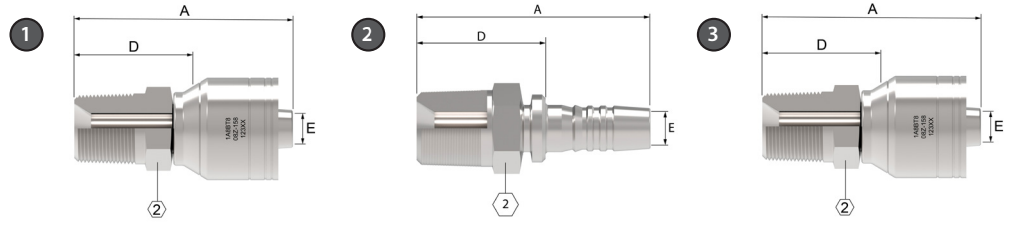

BT

BSP male tapered, BSPT†

PART			HOSE SIZE INFO		DIMENSIONS							
1	2	3	Thd.	Hose size	A		D		EØ		2	
1A part #	Nipple part #	OTC part #			mm	in	mm	in	mm	in	mm	in
1A4BT4	1S4BT4	1G4BT4	R 1/4 -19	-04	50,6	1.99	27,2	1.07	4,2	0.16	14,0	0.55
1A6BT6	1S6BT6	1G6BT6	R 3/8 -19	-06	54,9	2.16	29,6	1.16	6,7	0.26	19,0	0.75
1A8BT8	1S8BT8	1G8BT8	R 1/2 -14	-08	66,2	2.61	36,5	1.44	9,6	0.38	22,0	0.87
1A12BT12	1S12BT12	1G12BT12	R 3/4 -14	-12	71,1	2.80	40,9	1.61	15,5	0.61	30,0	1.18
1A16BT16	1S16BT16	1G16BT16	R 1 -11	-16	81,2	3.20	46,8	1.84	20,7	0.81	36,0	1.42
1A20BT20	1S20BT20	1G20BT20	R 1 1/4 -11	-20	96,2	3.79	52,2	2.05	26,6	1.05	46,0	1.81

†The JIS parallel thread and the BSPP connection are interchangeable.

Braided series

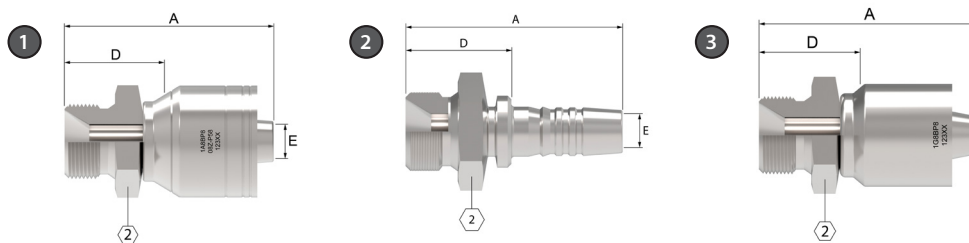

BP

BSP male parallel, BSPP

PART			HOSE SIZE INFO		DIMENSIONS							
1	2	3	Thd.	Hose size	A		D		EØ		2	
1A part #	Nipple part #	OTC part #			mm	in	mm	in	mm	in	mm	in
1A4BP4	1S4BP4	1G4BP4	G 1/4 -19	-04	44,3	1.74	20,9	0.82	4,2	0.16	19,0	0.75
1A6BP6	1S6BP6	1G6BP6	G 3/8 -19	-06	48,4	1.90	23,1	0.91	6,7	0.26	22,0	0.87
1A6BP8	1S6BP8	—	G 3/8 -19	-08	55,9	2.20	26,4	1.04	9,6	0.38	22,0	0.87
1A8BP6	1S8BP6	1G8BP6	G 1/2 -14	-06	52,4	2.06	27,1	1.07	6,7	0.26	27,0	1.06
1A8BP8	1S8BP8	1G8BP8	G 1/2 -14	-08	58,0	2.28	28,3	1.11	9,6	0.38	27,0	1.06
1A10BP10	1S10BP10	—	G 5/8 -14	-10	62,0	2.44	35,5	1.25	12,7	0.50	30,0	1.18
1A12BP12	1S12BP12	1G12BP12	G 3/4 -14	-12	63,1	2.48	32,9	1.29	15,5	0.61	32,0	1.26
1A16BP16	1S16BP16	1G16BP16	G1 -11	-16	70,9	2.79	36,5	1.44	20,7	0.81	41,0	1.61
1A20BP20	1S20BP20	—	G 1 1/4 -11	-20	86,1	3.39	42,2	1.66	26,6	1.50	50,0	1.97

G as part of thread size is ISO Designation for parallel thread.

Braided series

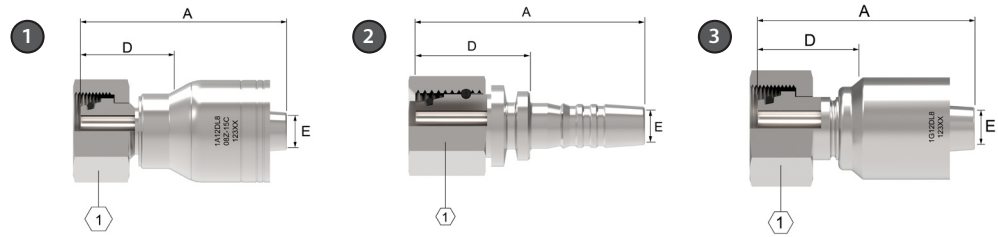

DL

DKO female swivel, light duty

PART			HOSE SIZE INFO			DIMENSIONS							
①	②	③	Thd.	Tube O.D.	Hose size	A		D		EØ		①	
1A part #	Nipple part #	OTC part #				mm	in	mm	in	mm	in	mm	in
1A5DL4	1S5DL4	1G5DL4	M12 x 1.5	6	-04	48,0	1.89	24,6	0.97	4,2	0.16	17,0	0.67
1A6DL4	S6DL4	1G6DL4	M14 x 1.5	8	-04	46,0	1.81	22,6	0.89	4,2	0.16	17,0	0.67
1A8DL4	1S8DL4	—	M16 x 1.5	10	-04	48,3	1.90	24,9	0.98	4,3	0.17	19,0	0.75
1A8DL6	1S8DL6	1G8DL6	M16 x 1.5	10	-06	56,9	2.24	31,6	1.24	6,7	0.26	19,0	0.75
1A10DL6	1S10DL6	1G10DL6	M18 x 1.5	12	-06	51,2	2.01	25,9	1.02	6,7	0.26	22,0	0.87
1A12DL8	1S12DL8	1G12DL8	M22 x 1.5	15	-08	58,3	2.29	28,6	1.12	9,6	0.38	27,0	1.06
1A16DL10	1S16DL10	1G16DL10	M26 x 1.5	18	-10	59,2	2.33	29,8	1.17	12,8	0.50	32,0	1.26
1A20DL12	1S20DL12	1G20DL12	M30 x 2	22	-12	62,5	2.46	32,3	1.27	15,5	0.61	36,0	1.42
1A25DL16	1S25DL16	1G25DL16	M36 x 2	28	-16	68,2	2.68	33,8	1.33	20,7	0.81	41,0	1.61
1A32DL20	1S32DL20	1G32DL20	M45 x 2	35	-20	83,7	3.29	39,7	1.56	26,6	1.05	50,0	1.97
1A40DL24	1S40DL24	1G40DL24	M52 x 2	42	-24	87,2	3.43	40,9	1.61	32,0	1.26	60,0	2.36

Braided series

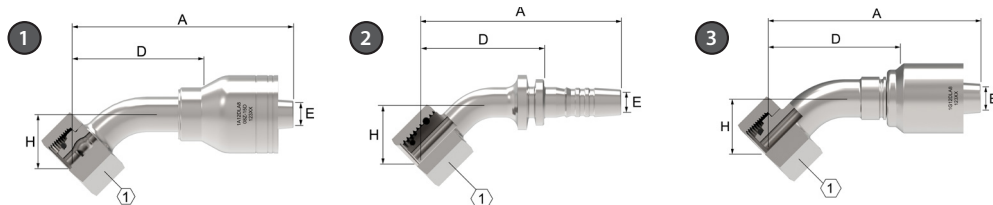

DLA

DKO female swivel, light duty 45° elbow

PART			HOSE SIZE INFO			DIMENSIONS									
①	②	③	Thd.	Tube O.D.	Hose size	A		D		EØ		H		①	
1A part #	Nipple part #	OTC part #				mm	in	mm	in	mm	in	mm	in	mm	in
1A6DLA4	1S6DLA4	1G6DLA4	M14 x 1.5	8	-04	62,4	2.46	39,0	1.53	4,2	0.16	17,5	0.69	17,0	0.67
1A8DLA4	1S8DLA4	—	M16 X 1.5	10	-06	64,8	2.55	41,5	1.63	4,2	0.17	18,4	0.72	19,0	0.75
1A8DLA6	1A8DLA6	1A8DLA6	M16 x 1.5	10	-06	66,8	2.63	41,5	1.63	6,7	0.26	19,0	0.75	19,0	0.75
1A10DLA6	1S10DLA6	1G10DLA6	M18 x 1.5	12	-08	69,8	2.75	44,5	1.75	6,7	0.26	20,5	0.81	22,0	0.87
1A12DLA8	1S12DLA8	1G12DLA8	M22 x 1.5	15	-10	81,7	3.22	52,0	2.05	9,6	0.38	21,5	0.85	27,0	1.06
1A16DLA10	1S16DLA10	1G16DLA10	M26 x 1.5	18	-12	88,4	3.48	59,0	2.32	12,8	0.50	27,5	1.08	32,0	1.26
1A20DLA12	1S20DLA12	1G20DLA12	M30 x 2	22	-16	98,4	3.87	68,2	2.68	15,5	0.61	26,0	1.02	36,0	1.42
1A25DLA16	1S25DLA16	1G25DLA16	M36 x 2	28	-20	120,0	4.72	85,6	3.37	20,7	0.81	33,5	1.32	41,0	1.61
1A32DLA20	—	—	M45 x 2	35		148,0	5.83	104,0	4.09	26,6	1.05	43,0	1.69	50,0	1.97

Braided series

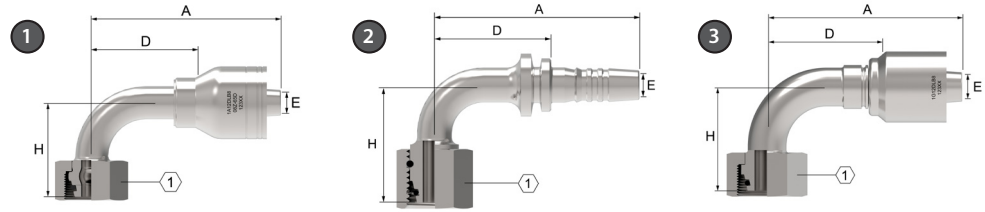

DLB

DKO female swivel, light duty, 90° elbow

PART			HOSE SIZE INFO			DIMENSIONS									
①	②	③	Thd.	Tube O.D.	Hose size	A		D		EØ		H		①	
1A part #	Nipple part #	OTC part #				mm	in	mm	in	mm	in	mm	in	mm	in
1A5DLB4	1S5DLB4	1G5DLB4	M12 x 1.5	6	-04	49,9	1.96	26,5	1.04	4,2	0.16	26,5	1.04	17,0	0.67
1A6DLB4	1S5DLB4	1G6DLB4	M14 x 1.5	8	-04	51,9	2.04	28,5	1.12	4,2	0.16	31,5	1.24	17,0	0.67
1A8DLB4	1S8DLB4	—	M16 x 1.5	10	-04	55,4	2.18	32,0	1.26	4,3	0.17	35,5	1.40	19,0	0.75
1A8DLB6	1S8DLB6	1G8DLB6	M16 x 1.5	10	-06	57,3	2.25	32,0	1.26	6,7	0.26	35,5	1.40	19,0	0.75
1A10DLB6	1S10DLB6	1G10DLB6	M18 x 1.5	12	-06	60,3	2.37	35,0	1.38	6,7	0.26	39,0	1.53	22,0	0.87
1A12DLB8	1S12DLB8	1G12DLB8	M22 x 1.5	15	-08	72,0	2.83	42,3	1.66	9,6	0.38	43,0	1.69	27,0	1.06
1A16DLB10	1S16DLB10	1G16DLB10	M26 x 1.5	18	-10	82,9	3.26	53,5	2.11	12,8	0.50	59,0	2.12	32,0	1.26
1A20DLB12	1S20DLB12	1G20DLB12	M30 x 2	22	-12	95,0	3.74	64,8	2.55	15,5	0.61	54,0	2.12	36,0	1.42
1A25DLB16	1S25DLB16	1G25DLB16	M36 x 2	28	-16	154,4	6.08	120,0	4.72	20,7	0.81	71,0	2.79	41,0	1.61
1A32DLB20	—	—	M45 x 2	35	-20	119,0	4.68	75,0	2.95	26,6	1.05	76,0	2.99	50,0	1.97

Braided series

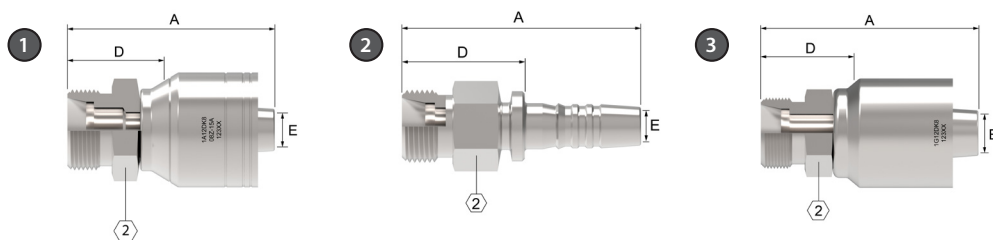

DK

24° male, light duty

PART			HOSE SIZE INFO			DIMENSIONS							
1	2	3	Thd.	Tube O.D.	Hose size	A		D		EØ		2	
1A part #	Nipple part #	OTC part #				mm	in	mm	in	mm	in	mm	in
1A5DK4	1S5DK4	1G5DK4	M12 x 1.5	6	-04	44,7	1.76	21,3	0.84	4,2	0.16	12,0	0.47
1A6DK4	1S6DK4	1G6DK4	M14 x 1.5	8	-04	44,5	1.75	21,1	0.83	4,2	0.16	14,0	0.55
1A8DK4	1S8DK4	—	M16 X 1.5	10	-04	46,0	1.81	22,6	0.89	4,3	0.17	17,0	0.67
1A8DK6	1S8DK6	1G8DK6	M16 x 1.5	10	-06	52,0	2.05	26,7	1.05	6,7	0.26	17,0	0.67
1A10DK6	1S10DK6	1G10DK6	M18 x 1.5	12	-06	49,0	1.93	23,7	0.93	6,7	0.26	19,0	0.75
1A12DK8	1S12DK8	1G12DK8	M22 x 1.5	15	-08	56,0	2.20	26,3	1.03	9,6	0.38	24,0	0.94
1A16DK10	1S16DK10	1G16DK10	M26 x 1.5	18	-10	56,0	2.20	26,6	1.05	12,8	0.50	27,0	1.06
1A20DK12	1S20DK12	1G20DK12	M30 x 2	22	-12	62,0	2.44	31,8	1.25	15,5	0.61	32,0	1.26
1A25DK16	1S25DK16	1G25DK16	M36 x 2	28	-16	66,0	2.60	31,6	1.24	20,7	0.81	41,0	1.61
1A32DK20	1S32DK20	1G32DK20	M45 x 2	35	-20	79,4	3.12	35,4	1.39	26,6	1.05	46,0	1.81

Braided series

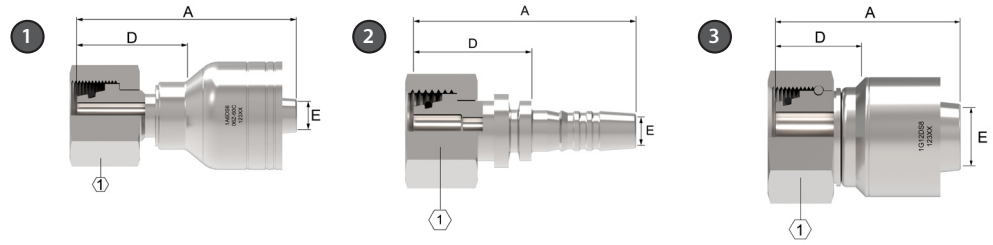

DS

DKO female swivel, heavy duty

PART			HOSE SIZE INFO			DIMENSIONS							
①	②	③	Thd.	Tube O.D.	Hose size	A		D		EØ		①	
1A part #	Nipple part #	OTC part #				mm	in	mm	in	mm	in	mm	in
1A5DS4	1S5DS4	1G5DS4	M16 x 1.5	8	-04	49,6	1.95	26,2	1.03	4,2	0.16	19,0	0.75
1A6DS4	1S6DS4	1G6DS4	M18 x 1.5	10	-04	50,8	2.00	27,4	1.08	4,2	0.16	22,0	0.87
1A8DS4	1S8DS4	—	M20 X 1.5	12	-04	50,8	2.00	27,4	1.08	4,3	0.17	24,0	0.94
1A6DS6	1S6DS6	—	M18 X 1.5	10	-06	52,8	2.08	27,7	1.09	6,6	0.26	22,0	0.87
1A8DS6	1S8DS6	1G8DS6	M20 x 1.5	12	-06	53,8	2.12	28,5	1.12	6,7	0.26	24,0	0.94
1A10DS6	1S10DS6	1G10DS6	M22 x 1.5	14	-06	56,9	2.24	31,6	1.24	6,7	0.26	27,0	1.06
1A10DS8	1S10DS8	—	M22 x 1.5	14	-08	55,2	2.17	25,5	1.00	9,6	0.38	27,0	1.06
1A12DS8	1S12DS8	1G12DS8	M24 x 1.5	16	-08	62,4	2.46	32,7	1.29	9,6	0.38	30,0	1.18
1A16DS10	1S16DS10	1G16DS10	M30 x 2	20	-10	66,9	2.63	37,5	1.48	12,8	0.50	36,0	1.42
1A16DS12	1S16DS12	—	M30 x 2	20	-12	60,2	2.37	30,2	1.19	14,0	0.55	36,0	1.42
1A20DS12	1S20DS12	1G20DS12	M36 x 2	25	-12	72,0	2.83	41,8	1.64	15,5	0.61	46,0	1.81
1A25DS16	1S25DS16	1G25DS16	M42 x 2	30	-16	78,5	3.09	44,1	1.44	20,7	0.81	50,0	1.97
1A32DS20	—	—	M52 x 2	38	-20	93,7	3.69	49,7	1.96	26,6	1.05	60,0	2.36

Braided series

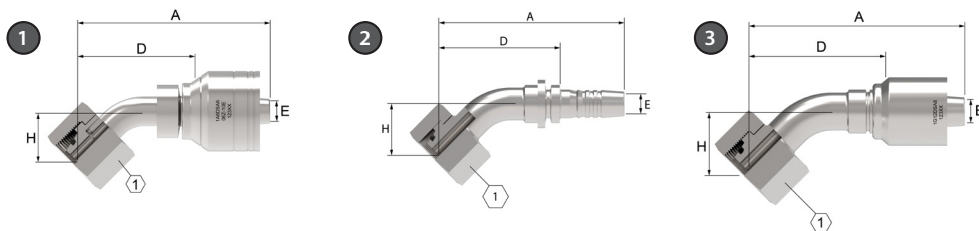

DSA

DKO female swivel, heavy duty, 45° elbow

PART			HOSE SIZE INFO			DIMENSIONS									
1	2	3	Thd.	Tube O.D.	Hose size	A		D		EØ		H		1	
1A part #	Nipple part #	OTC part #				mm	in	mm	in	mm	in	mm	in	mm	in
1A6DSA4	1S6DSA4	1G6DSA4	M18 x 1.5	10	-04	61,4	2.42	38,0	1.50	4,2	0.16	17,0	0.67	22,0	0.87
1A8DSA6	1S8DSA6	1G8DSA6	M20 x 1.5	12	-06	68,3	2.69	43,0	1.69	6,7	0.26	19,0	0.75	24,0	0.94
1A10DSA6	1S10DSA6	1G10DSA6	M22 x 1.5	14	-06	68,8	2.71	43,5	1.71	6,7	0.26	20,0	0.79	27,0	1.06
1A12DSA8	1S12DSA8	1G12DSA8	M24 x 1.5	16	-08	79,7	3.14	50,0	1.97	9,6	0.38	23,0	0.90	30,0	1.18
1A16DSA10	1S16DSA10	1G16DSA10	M30 x 2	20	-10	89,3	3.51	59,9	2.36	12,8	0.50	26,0	1.02	36,0	1.42
1A20DSA12	1S20DSA12	1G20DSA12	M36 x 2	25	-12	107,4	4.23	77,2	3.04	15,5	0.61	32,5	1.28	46,0	1.81
1A25DSA16	1S25DSA16	1G25DSA16	M42 x 2	30	-16	121,4	4.78	87,0	3.42	20,7	0.81	37,5	1.48	55,0	2.16

Braided series

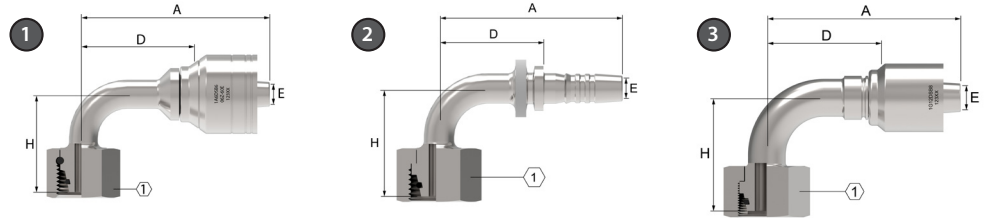

DSB

DKO female swivel, heavy duty, 90° elbow

PART			HOSE SIZE INFO			DIMENSIONS									
①	②	③	Thd.	Tube O.D.	Hose size	A		D		EØ		H		①	
1A part #	Nipple part #	OTC part #				mm	in	mm	in	mm	in	mm	in	mm	in
1A6DSB4	1S6DSB4	1G6DSB4	M18 x 1.5	10	-04	54,5	2.14	31,0	1.22	4,2	0.16	33,5	1.32	22,0	0.87
1A8DSB6	1S8DSB6	1G8DSB6	M20 x 1.5	12	-06	60,3	2.37	35,0	1.38	6,7	0.26	35,0	1.38	24,0	0.94
1A10DSB6	1S10DSB6	1G10DSB6	M22 x 1.5	14	-06	63,8	2.51	38,5	1.51	6,7	0.26	42,0	1.65	27,0	1.06
1A12DSB8	1S12DSB8	1G12DSB8	M24 x 1.5	16	-08	73,7	2.90	44,0	1.73	9,6	0.38	49,0	1.93	30,0	1.18
1A16DSB10	1S16DSB10	1G16DSB10	M30 x 2	20	-10	82,0	3.23	52,6	2.07	12,8	0.50	53,5	2.11	36,0	1.42
1A20DSB12	1S20DSB12	1G20DSB12	M36 x 2	25	-12	93,0	3.66	62,8	2.47	15,5	0.61	64,5	2.54	46,0	1.81
1A25DSB16	1S25DSB16	1G25DSB16	M42 x 2	30	-16	104,0	4.09	69,6	2.74	20,7	0.81	74,0	2.91	50,0	1.97

Braided series

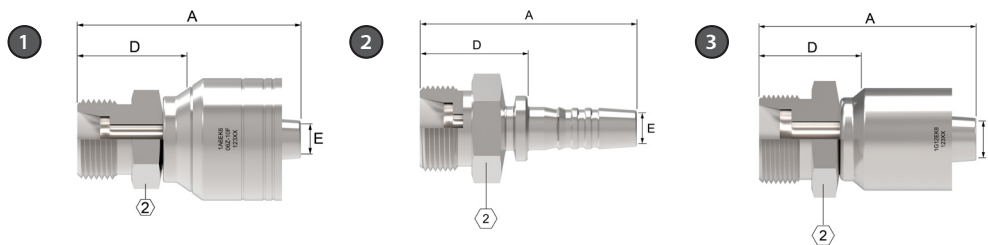

EK

24° male, heavy duty

PART			HOSE SIZE INFO			DIMENSIONS							
1	2	3	Thd.	Tube O.D.	Hose size	A		D		EØ		2	
1A part #	Nipple part #	OTC part #				mm	in	mm	in	mm	in	mm	in
1A4EK4	1S4EK4	—	M12 x 1.5	6	-04	44,7	1.76	21,3	0.84	4,2	0.16	12,0	0.47
1A5EK4	1S5EK4	1G5EK4	M16 x 1.5	8	-04	47,5	1.87	24,1	0.95	4,2	0.16	17,0	0.67
1A6EK4	1S6EK4	1G6EK4	M18 x 1.5	10	-04	40,7	1.60	23,6	0.93	4,2	0.16	19,0	0.75
1A6EK6	1S6EK6	—	M18 x 1.5	10	-06	49,5	1.94	24,2	0.95	6,7	0.26	19,0	0.75
1A8EK6	1S8EK6	1G8EK6	M20 x 1.5	12	-06	50,3	1.98	25,0	0.98	6,7	0.26	22,0	0.87
1A10EK6	1S10EK6	1G10EK6	M22 x 1.5	14	-06	52,6	2.07	27,3	1.07	6,7	0.26	24,0	0.94
1A12EK8	1S12EK8	1G12EK8	M24 x 1.5	16	-08	58,0	2.28	28,3	1.11	9,6	0.38	27,0	1.06
1A16EK10	1S16EK10	1G16EK10	M30 x 2	20	-10	62,0	2.44	32,7	1.29	12,8	0.50	32,0	1.26
1A16EK12	1S16EK12	—	M30 x 2	20	-12	57,7	2.27	30,7	1.21	15,5	0.61	32,0	1.26
1A20EK12	1S20EK12	1G20EK12	M36 x 2	25	-12	65,5	2.58	35,3	1.39	15,5	0.61	41,0	1.61
1A25EK16	1S25EK16	1G25EK16	M42 x 2	30	-16	72,3	2.85	37,9	1.49	20,7	0.81	46,0	1.81

Braided series

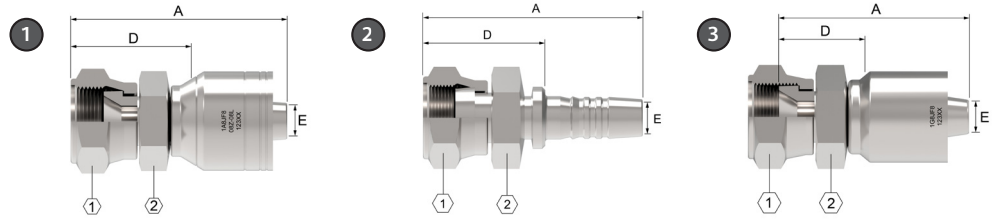

JF

JIS female swivel

PART			HOSE SIZE INFO		DIMENSIONS									
1	2	3	Thd.	Hose size	A		D		EØ		1		2	
1A part #	Nipple part #	OTC part #			mm	in	mm	in	mm	in	mm	in	mm	in
1A4JF4	1S4JF4	1G4JF4	G 7/16 -20	-04	53,2	2.09	27,3	1.08	4,2	0.17	19,0	0.75	19,0	0.75
1A6JF6	1S6JF6	1G6JF6	G 3/8 -19	-06	59,2	2.33	33,9	1.33	6,7	0.26	22,0	0.87	22,0	0.87
1A8JF8	1A8JF8	1A8JF8	G 1/2 -14	-08	66,8	2.62	36,6	1.44	9,6	0.38	27,0	1.06	27,0	1.06
1A12JF10	1S12JF10	—	G 3/4 -14	-10	62,3	2.45	32,9	1.29	12,7	0.50	32,0	1.26	36,0	1.42
1A12JF12	1S12JF12	1G12JF12	G 3/4 -14	-12	73,3	2.88	43,1	1.70	15,5	0.61	32,0	1.26	36,0	1.42
1A16JF16	1S16JF16	1G16JF16	G1 -11	-16	83,6	3.29	49,2	1.94	20,7	0.81	41,0	1.61	41,0	1.61
1A20JF20	1S20JF20	1G20JF20	G 1 1/4 -11	-20	102,1	4.02	58,1	2.29	26,6	1.05	50,0	1.97	46,0	1.81

G as part of thread size is ISO Designation for parallel thread.

Braided series

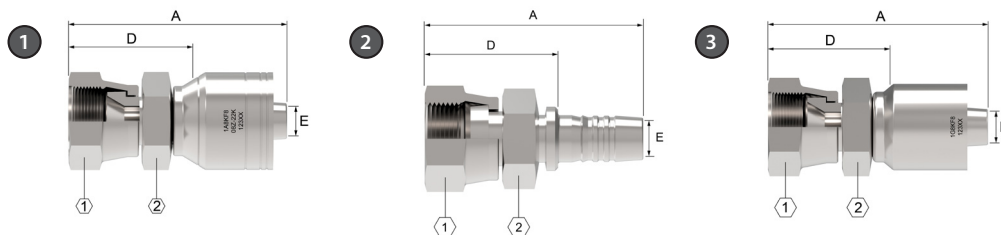

KF

Komatsu female swivel

PART			HOSE SIZE INFO		DIMENSIONS									
1	2	3	Thd.	Hose size	A		D		E∅		1		2	
1A part #	Nipple part #	OTC part #			mm	in	mm	in	mm	in	mm	in	mm	in
1A4KF4	1S4KF4	1G4KF4	M14 x 1.5	-04	56,1	2.21	32,7	1.29	42,2	1.66	19,0	0.75	19,0	0.75
1A6KF6	1S6KF6	1G6KF6	M18 x 1.5	-06	60,4	2.38	35,1	1.38	6,7	0.26	24,0	0.94	22,0	0.87
1A8KF8	1S8KF8	1G8KF8	M22 x 1.5	-08	69,5	2.74	39,8	1.57	9,6	0.38	27,0	1.06	27,0	1.06
1A10KF10	1S10KF10	1G10KF10	M24 x 1.5	-10	75,4	2.96	46,0	1.81	12,4	0.49	31,7	1.25	30,0	1.18
1A10KF12	1S10KF12	1G10KF12	M24 x 1.5	-12	76,6	3.01	46,4	1.83	12,4	0.49	32,0	1.26	30,0	1.18
1A12KF12	1S12KF12	1G12KF12	M30 x 1.5	-12	81,5	3.21	51,3	2.02	15,5	0.61	36,0	1.42	36,0	1.42
1A16KF16	1S16KF16	1G16KF16	M33 x 1.5	-16	91,4	3.60	57,0	2.24	20,7	0.81	41,0	1.61	41,0	1.61
1A20KF20	1S20KF20	1G20KF20	M36 x 1.5	-20	113,4	4.46	69,4	2.73	26,6	1.05	46,0	1.81	46,0	1.81

Braided series

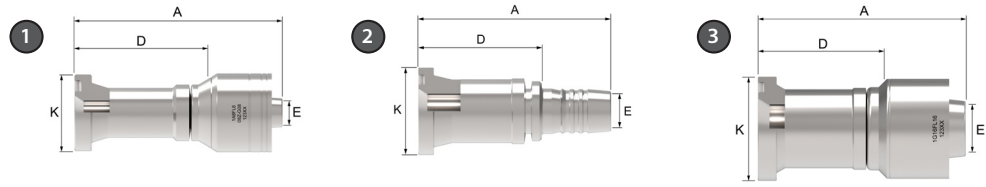

FL

SAE code 61 split flange

PART			HOSE SIZE INFO		DIMENSIONS					
1	2	3	Thd. Flange head Dia. K Ø	Hose size	A		D		EØ	
1A part #	Nipple part #	OTC part #			mm	in	mm	in	mm	in
1A8FL8	1S8FL8	1G8FL8	1.19	-08	82,0	3.23	52,3	2.06	9,7	0.38
1A12FL8	1S12FL8	1G12FL8	1.50	-08	83,1	3.27	53,3	2.10	9,7	0.38
1A12FL10	1S12FL10	1G12FL10	1.50	-10	82,8	3.26	53,3	2.10	12,7	0.50
1A12FL12	1S12FL12	1G12FL12	1.50	-12	84,1	3.31	53,8	2.12	15,5	0.61
1A16FL12	1S16FL12	1G16FL12	1.75	-12	84,1	3.31	53,8	2.12	15,5	0.61
1A20FL12	1S20FL12	1G20FL12	2.00	-12	91,7	3.61	61,5	2.42	15,5	0.61
1A12FL16	1S12FL16	—	1.50	-16	89,0	3.50	54,4	2.14	14,7	0.58
1A16FL16	1S16FL16	1G16FL16	1.75	-16	88,6	3.49	54,4	2.14	20,8	0.82
1A20FL16	1S20FL16	1G20FL16	2.00	-16	96,3	3.79	62,0	2.44	20,8	0.82
1A24FL16	1S24FL16	1G24FL16	2.38	-16	97,3	3.83	62,7	2.47	20,8	0.82
1A16FL20	1S16FL20	1G16FL20	1.75	-20	100,1	3.94	56,1	2.21	20,8	0.82
1A20FL20	1S20FL20	1G20FL20	2.00	-20	107,7	4.24	63,8	2.51	26,7	1.05
1A24FL20	1S24FL20	1G24FL20	2.38	-20	108,5	4.27	64,5	2.54	26,7	1.05
1A32FL20	1S32FL20	1G32FL20	2.81	-20	108,5	4.27	64,5	2.54	25,7	1.01
1A20FL24	1S20FL24	1G20FL24	2.00	-24	111,0	4.37	64,8	2.55	26,7	1.05
1A24FL24	1S24FL24	1G24FL24	2.38	-24	111,8	4.40	65,5	2.58	32,0	1.26
1A32FL24	1S32FL24	1G32FL24	2.81	-24	111,8	4.40	65,5	2.58	30,2	1.19
1A24FL32	1S24FL32	1G24FL32	2.38	-32	117,1	4.61	66,8	2.63	32,0	1.26
1A32FL32	1S32FL32	1G32FL32	2.81	-32	117,1	4.61	66,8	2.63	44,5	1.75
1A40FL32	1S40FL32	1G40FL32	3.31	-32	116,8	4.60	66,8	2.63	44,5	1.75

Braided series

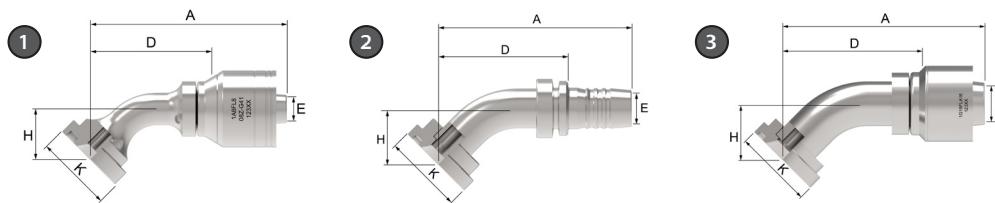

FLA

SAE code 61 split flange 45° elbow

PART			HOSE SIZE INFO		DIMENSIONS							
1	2	3	Thd.Flange head Dia. K Ø	Hose size	A		D		EØ		H	
1A part #	Nipple part #	OTC part #			mm	in	mm	in	mm	in	mm	in
1A8FLA8	1S8FLA8	1G8FLA8	1.19	-08	79,0	3.11	49,3	1.94	9,4	0.37	19,8	0.78
1A12FLA8	1S12FLA8	1G12FLA8	1.50	-08	92,5	3.64	62,7	2.47	9,4	0.37	25,4	1.00
1A12FLA10	1S12FLA10	1G12FLA10	1.50	-10	93,5	3.68	64,3	2.53	11,7	0.46	25,4	1.00
1A12FLA12	1S12FLA12	1G12FLA12	1.50	-12	93,2	3.67	63,0	2.48	14,7	0.58	25,7	1.01
1A16FLA12	1S16FLA12	1G16FLA12	1.75	-12	105,7	4.16	75,4	2.97	14,7	0.58	26,9	1.06
1A12FLA16	1S12FLA16	—	1.50	-16	99,8	3.93	65,3	2.57	14,7	0.58	25,7	1.01
1A16FLA16	1S16FLA16	1G16FLA16	1.75	-16	110,5	4.35	76,2	3.00	19,3	0.76	26,9	1.06
1A20FLA16	1S20FLA16	1G20FLA16	2.00	-16	122,2	4.81	87,6	3.45	19,3	0.76	29,2	1.15
—	1S16FLA20	1G16FLA20	1.75	-20	121,9	4.80	77,7	3.06	19,3	0.76	26,9	1.06
1A16FLA20	—	—	1.75	-20	121,9	4.80	77,7	3.06	19,3	0.76	26,9	1.06
—	1S20FLA20	1G20FLA20	2.00	-20	134,1	5.28	90,2	3.55	25,7	1.01	30,0	1.18
1A20FLA20	—	—	2.00	-20	134,1	5.28	90,2	3.55	25,7	1.01	30,0	1.18
1A24FLA20	1S24FLA20	1G24FLA20	2.37	-20	150,9	5.94	106,7	4.20	25,7	1.01	35,8	1.41
1A20FLA24	1S20FLA24	1G20FLA24	2.00	-24	115,3	4.54	69,1	2.72	32,0	1.26	27,4	1.08
1A24FLA24	1S24FLA24	1G24FLA24	2.37	-24	154,2	6.07	108,0	4.25	32,0	1.26	35,8	1.41
1A32FLA24	1S32FLA24	—	2.81	-24	154,2	6.07	108,0	4.25	32,0	1.26	35,8	1.41
1A24FLA32	1S24FLA32	1G24FLA32	2.37	-32	159,3	6.27	109,0	4.29	32,0	1.26	35,8	1.41
1A32FLA32	1S32FLA32	1G32FLA32	2.81	-32	190,2	7.49	140,2	5.52	44,5	1.75	50,8	2.00
1A40FLA32	1S40FLA32	1G40FLA32	3.31	-32	133,9	5.27	83,6	3.29	44,5	1.75	33,0	1.30

For flanges, split flange halves, kits and o-rings, see pages 241-247.

Braided series

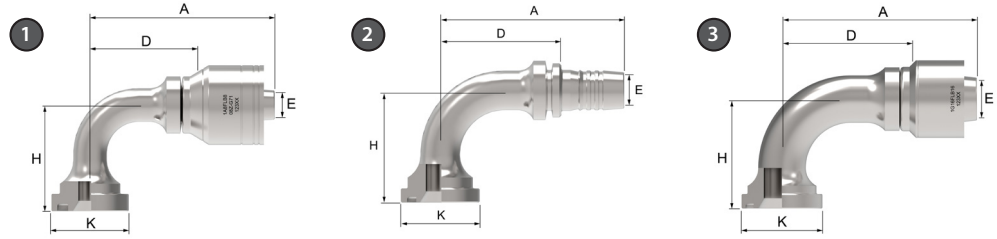

FLB

SAE code 61 split flange 90° elbow

PART			HOSE SIZE INFO		DIMENSIONS							
1	2	3	Thd. Flange head Dia. K Ø	Hose size	A		D		EØ		H	
1A part #	Nipple part #	OTC part #			mm	in	mm	in	mm	in	mm	in
1A8FLB8	1S8FLB8	1G8FLB8	1.19	08	72,6	2.86	42,3	1.69	9,4	0.37	41,4	1.63
1A12FLB8	1S12FLB8	1G12FLB8	1.50	08	87,6	3.45	57,9	2.28	9,4	0.37	54,1	2.13
1A12FLB10	1S12FLB10	1G12FLB10	1.50	10	87,4	3.44	58,2	2.29	12,7	0.50	54,1	2.13
1A12FLB12	1S12FLB12	1G12FLB12	1.50	12	88,6	3.49	58,4	2.30	14,7	0.58	54,1	2.13
1A16FLB12	1S16FLB12	1G16FLB12	1.75	12	102,4	4.03	72,1	2.84	15,5	0.61	60,3	2.38
1A20FLB12	1S20FLB12	—	2.00	12	118,6	4.67	88,4	3.48	14,7	0.58	66,5	2.62
1A12FLB16	1S12FLB16	1G12FLB16	1.50	16	106,7	4.20	72,4	2.85	19,3	0.76	55,1	2.17
1A16FLB16	1S16FLB16	1G16FLB16	1.75	16	107,2	4.22	72,6	2.86	19,3	0.76	60,5	2.38
1A20FLB16	1S20FLB16	1G20FLB16	2.00	16	123,2	4.85	89,0	3.50	19,3	0.76	66,5	2.62
1A24FLB16	1S24FLB16	1G24FLB16	2.37	16	142,0	5.59	107,7	4.24	19,3	0.76	79,2	3.12
1A16FLB20	1S16FLB20	1G16FLB20	1.75	20	118,4	4.66	74,4	2.93	19,3	0.76	60,5	2.38
1A20FLB20	1S20FLB20	1G20FLB20	2.00	20	134,6	5.30	90,7	3.57	25,7	1.01	66,5	2.62
—	1S24FLB20	1G24FLB20	2.37	20	153,4	6.04	109,5	4.31	25,7	1.01	79,2	3.12

Braided series

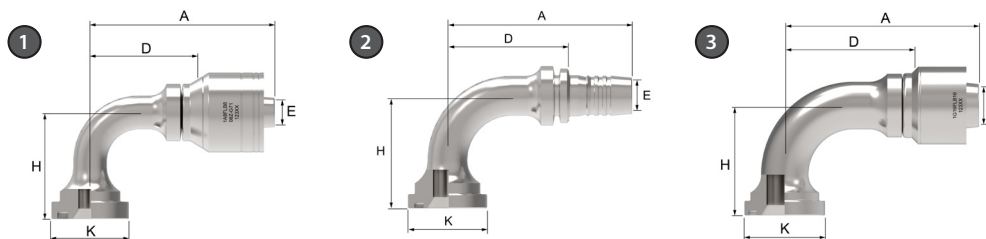

FLB

SAE code 61 split flange 90° elbow (cont.)

PART			HOSE SIZE INFO		DIMENSIONS							
1	2	3	Thd. Flange head Dia. K Ø	Hose size	A		D		EØ		H	
1A part #	Nipple part #	OTC part #			mm	in	mm	in	mm	in	mm	in
1A24FLB20	—	—	2.37	-20	153,4	6.04	109,5	4.31	25,7	1.01	79,2	3.12
—	1S32FLB20	1G32FLB20	2.81	-20	108,0	4.25	64,0	2.52	25,7	1.01	65,0	2.56
1A16FLB24	1S16FLB24	1G16FLB24	1.75	-24	121,9	4.80	75,4	2.97	19,3	0.76	60,5	2.38
1A20FLB24	1S20FLB24	1G20FLB24	2.00	-24	137,9	5.43	91,7	3.61	25,7	1.01	66,5	2.62
1A24FLB24	1S24FLB24	1G24FLB24	2.37	-24	157,0	6.18	110,5	4.35	32,0	1.26	79,2	3.12
1A32FLB24	1S32FLB24	1G32FLB24	2.81	-24	184,9	7.28	138,4	5.45	32,0	1.26	114,3	4.50
1A24FLB32	1S24FLB32	—	2.37	-32	161,8	6.37	111,8	4.40	32,0	1.26	79,2	3.12
1A32FLB32	1S32FLB32	1G32FLB32	2.81	-32	189,7	7.47	139,4	5.49	44,5	1.75	114,3	4.50
1A40FLB32	1S40FLB32	1G40FLB32	3.31	-32	189,7	7.47	139,4	5.49	44,5	1.75	115,8	4.56

For flanges, split flange halves, kits and o-rings, see pages 241-247.

Braided series

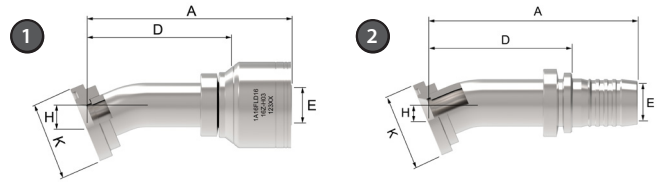

FLD

SAE code 61 split flange 22 1/2° elbow

PART		HOSE SIZE INFO		DIMENSIONS							
1	2	Thd. Flange head Dia. K Ø	Hose size	A		D		EØ		H	
1A part #	Nipple part #			mm	in	mm	in	mm	in	mm	in
1A16FLD16	1S16FLD16	1.75	-16	117,9	4.64	83,6	3.29	19,3	0.76	11,4	0.45
1A20FLD16	1S20FLD16	2.00	-16	130,0	5.12	95,8	3.77	19,3	0.76	11,7	0.46
1A20FLD20	1S20FLD20	2.00	-20	141,5	5.57	97,3	3.83	25,7	1.01	11,7	0.46

For flanges, split flange halves, kits and o-rings, see pages 241-247.

Braided series

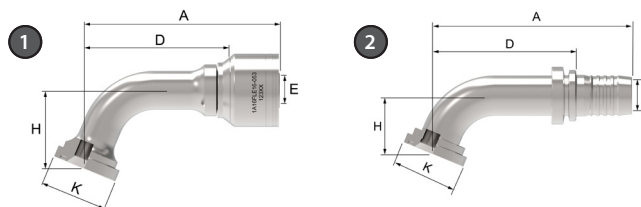

FLE

SAE code 61 split flange 67 1/2° elbow

PART		HOSE SIZE INFO		DIMENSIONS							
1	2	Thd. Flange head Dia. K Ø	Hose size	A		D		E Ø		H	
1A part #	Nipple part #			mm	in	mm	in	mm	in	mm	in
1A20FLE20	1S20FLE20	2.00	-20	157,0	6.18	112,8	4.44	25,7	1.01	46,5	1.83
1A24FLE20	1ST24FLE20	2.37	-24	189,7	7.47	143,5	5.65	30,2	1.19	46,0	1.81

For flanges, split flange halves, kits and o-rings, see pages 241-247.

Braided series

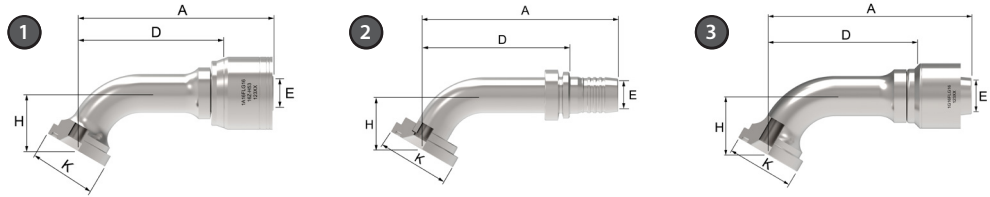

FLG

SAE code 61 split flange 60° elbow

PART			HOSE SIZE INFO		DIMENSIONS							
1	2	3	Thd. Flange head Dia. K Ø	Hose size	A		D		EØ		H	
1A part #	Nipple part #	OTC part #			mm	in	mm	in	mm	in	mm	in
1A16FLG16	1S16FLG16	1G16FLG16	1.75	-16	133,1	5.24	98,8	3.89	19,9	0.78	38,4	1.51
—	1S20FLG16	—	2.00	-16	151,1	5.95	116,8	4.60	19,3	0.76	39,9	1.57
1A24FLG24	1S24FLG24	1G24FLG24	2.37	-24	189,7	7.47	143,5	5.65	30,2	1.19	46,0	1.81

For flanges, split flange halves, kits and o-rings, see pages 241-247.

Braided series

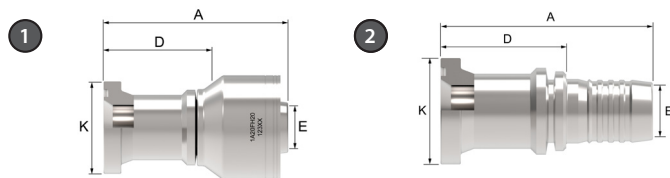

FH

SAE code 62 split flange

PART			HOSE SIZE INFO		DIMENSIONS					
1	2	3	Thd. Flange head Dia. K Ø	Hose size	A		D		E Ø	
1A part #	Nipple part #	OTC part #			mm	in	mm	in	mm	in
1A20FH20	1S20FH20	—	2.13	-20	107,7	4.24	63,8	2.51	26,7	1.05

For flanges, split flange halves, kits and o-rings, see pages 241-247.

Braided series

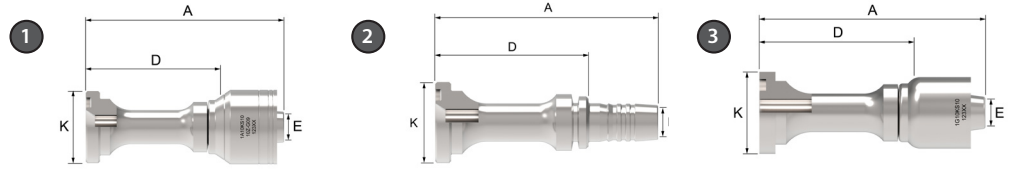

KS

Komatsu split flange

PART			HOSE SIZE INFO		DIMENSIONS					
1	2	3	Thd. Flange head Dia. K Ø	Hose size	A		D		EØ	
1A part #	Nipple part #	OTC part #			mm	in	mm	in	mm	in
1A10KS10	1S10KS10	1G10KS10	34.2	-10	94,2	0.16	64,8	2.55	11,5	0.45

Braided series

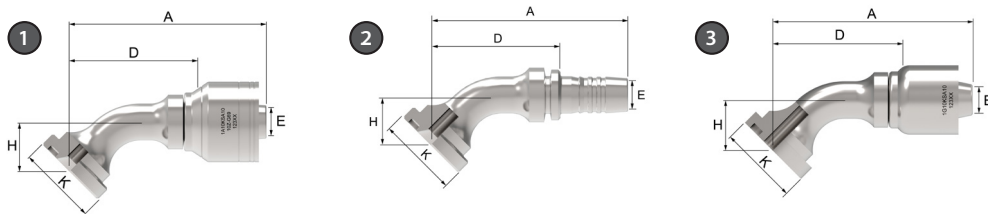

KSA

Komatsu split flange 45° elbow

PART			HOSE SIZE INFO		DIMENSIONS							
1	2	3	Thd. Flange head Dia. K Ø	Hose size	A		D		E Ø		H	
1A part #	Nipple part #	OTC part #			mm	in	mm	in	mm	in	mm	in
1A10KSA10	1S10KSA10	1G10KSA10	34.2	-10	86,1	3.39	56,7	2.23	11,5	0.45	21,8	0.86

Braided series

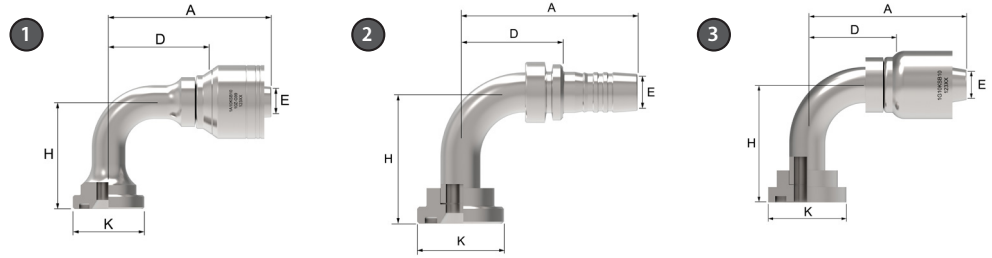

KSB

Komatsu split flange 90° elbow

PART			HOSE SIZE INFO		DIMENSIONS							
1	2	3	Thd. Flange head Dia. K Ø	Hose size	A		D		EØ		H	
1A part #	Nipple part #	OTC part #			mm	in	mm	in	mm	in	mm	in
1A10KSB10	1S10KSB10	1G10KSB10	34.2	-10	69.8	2.75	40,4	1.59	11,7	0.46	51,3	2.02

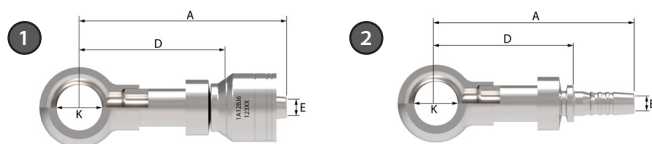

BJ

Banjo

PART		DIMENSIONS								
1	2	Hose size	A		D		K		EØ	
1A part #	Nipple part #		mm	in	mm	in	mm	in	mm	in
1A6BJ4		-04	68.8	2.71	45.4	1.79	12.1	0.48	4.2	0.17
1A8BJ4		-04	70.9	2.79	47.5	1.87	14.1	0.56	4.2	0.17
1A8BJ6		-06	76.2	3.00	50.9	2.00	14.1	0.56	6.7	0.26
1A10BJ6		-06	76.9	3.03	51.6	2.03	16.1	0.63	6.7	0.26
1A12BJ6	1S12BJ6	-06	83.2	3.28	57.9	2.28	18.1	0.71	6.7	0.26
1A12BJ8		-08	85.4	3.36	55.7	2.19	18.1	0.71	9.6	0.38
1A16BJ10		-10	92.5	3.64	63.1	2.48	22.1	0.87	12.8	0.50

Braided series

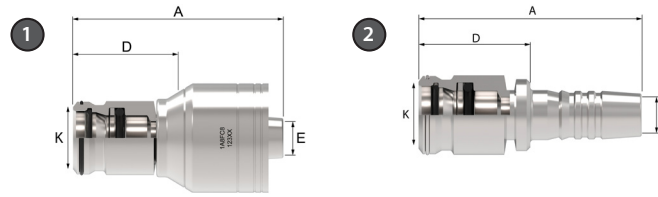

FC

Female snap to connect (STC)

PART		DIMENSIONS								
1	2	Hose size	A		D		K		EØ	
1A part #	Nipple part #		mm	in	mm	in	mm	in	mm	in
1A6FC4		-04	43.4	1.71	23.2	0.91	17.6	0.69	4.2	0.17
1A6FC6	1S6FC6	-06	50.1	1.97	28.2	1.11	17.6	0.69	6.7	0.26
1A8FC8	1S8FC8	-08	55.4	2.18	29.9	1.18	20.6	0.81	9.6	0.38
1A10FC8	1S10FC8	-08	60.2	2.37	34.7	1.37	24.7	0.97	9.6	0.38
1A10FC10	1S10FC10	-10	58.5	2.30	32.4	1.28	24.7	0.97	12.8	0.50
	1S12FC10	-10	67.3	2.65	37.9	1.49	31.2	1.23	12.8	0.50
1A12FC12	1S12FC12	-12	64.2	2.53	37.1	1.46	31.2	1.23	15.5	0.61
	1S16FC16	-16	79.9	3.15	45.3	1.78	41.0	1.61	20	0.79

Braided series

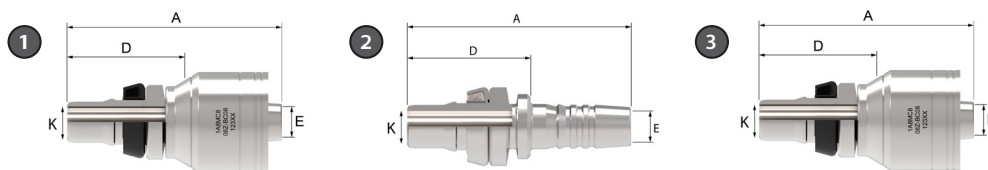

MC

Male snap to connect (STC)

PART			DIMENSIONS						
1	2	3	Hose size	A		D		K	
1A part #	Nipple part #	OTC part #		mm	in	mm	in	mm	in
1A4MC4			-04	46.5	1.83	26.5	1.04	4.2	0.17
1A6MC4	1S6MC4	1G6MC4	-04	49.2	1.94	29.0	1.14	6.6	0.26
1A6MC6	1S6MC6	1G6MC6	-06	51.3	2.02	30.2	1.19	6.6	0.26
1A8MC6	1S8MC6		-06	56	2.20	34.8	1.37	8.8	0.35
1A6MC8	1S6MC8		-08	56.9	2.24	31.4	1.24	6.6	0.26
1A8MC8	1S8MC8	1G8MC8	-08	62	2.44	36.6	1.44	8.8	0.35
1A10MC8			-08	69.1	2.72	43.2	1.70	11.5	0.45
1A12MC8	1S12MC8		-08	69.4	2.73	43.9	1.73	13.9	0.55
1A8MC10			-10	63.5	2.50	37.4	1.47	8.8	0.35
1A10MC10	1S10MC10	1G10MC10	-10	65.7	2.59	39.6	1.56	11.5	0.45
1A10MC12	1S10MC12		-12	72.2	2.84	45.1	1.78	11.5	0.45
1A12MC12	1S12MC12	1G12MC12	-12	71.3	2.81	44.4	1.75	13.9	0.55
1A16MC12	1S16MC12		-12	80.9	3.19	53.8	2.12	19.9	0.78
1A12MC16			-16	79.3	3.12	44.9	1.77	13.9	0.55
1A16MC16	1S16MC16	1G16MC16	-16	83.1	3.27	49.3	1.94	19.9	0.78
1A16MC20	1S16MC20		-20	90.5	3.56	51.0	2.01	19.9	0.78

Braided series

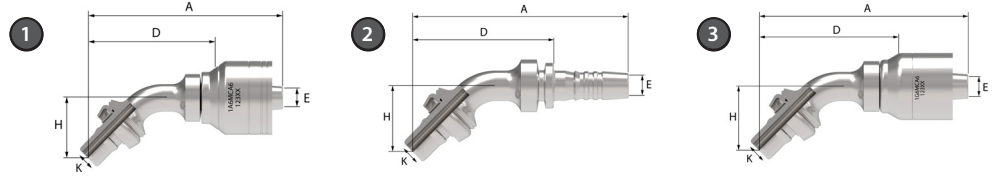

MCA

Male snap to connect (STC) 45° elbow

PART			DIMENSIONS								
1	2	3	Hose size	A		D		K		H	
1A part #	Nipple part #	OTC part #		mm	in	mm	in	mm	in	mm	in
	1S4MCA4		-04	64.6	2.54	41.2	1.62	4.2	0.17	21.2	0.83
1A6MCA4	1S6MCA4		-04	69.8	2.75	46.4	1.83	6.6	0.26	22.2	0.87
1A6MCA6	1S6MCA6	1G6MCA6	-06	68.9	2.71	47.6	1.87	6.6	0.26	22.2	0.87
1A8MCA6			-06	80.2	3.16	59.0	2.32	8.8	0.35	29.6	1.17
1A8MCA8	1S8MCA8		-08	86.7	3.41	60.2	2.37	8.8	0.35	29.6	1.17
1A10MCA8			-08	93.7	3.69	68.2	2.69	11.5	0.45	33.6	1.32
1A10MCA10	1S10MCA10		-10	94.4	3.72	68.4	2.69	11.5	0.45	33.6	1.32
1A12MCA12	1S12MCA12		-12	107.1	4.22	80.0	3.15	13.9	0.55	40.7	1.60
1A16MCA16	1S16MCA16		-16	136.1	5.36	101.7	4.00	19.9	0.78	52.5	2.07

Braided series

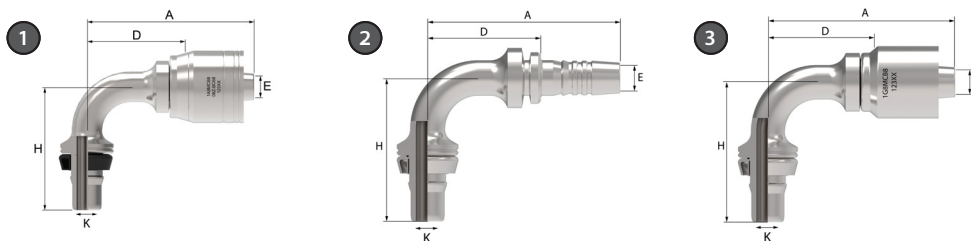

MCB

Male snap to connect (STC) 90° elbow

PART			DIMENSIONS								
1	2	3	Hose size	A		D		K		H	
1A part #	Nipple part #	OTC part #		mm	in	mm	in	mm	in	mm	in
1A4MCB4			-04	49.7	1.96	29.6	1.17	4.2	0.17	36.1	1.42
1A6MCB4	1S6MCB4	1G6MCB4	-04	53	2.09	32.8	1.29	6.6	0.26	39.6	1.56
1A6MCB6	1S6MCB6	1G6MCB6	-06	55.3	2.18	34.0	1.34	6.6	0.26	39.6	1.56
1A6MCB6.055			-06	55.3	2.18	34.0	1.34	6.6	0.26	54.8	2.16
1A8MCB6	1S8MCB6		-06	62.4	2.46	41.1	1.62	8.8	0.35	52.4	2.06
1A8MCB8	1S8MCB8	1G8MCB8	-08	67.8	2.67	42.3	1.67	8.8	0.35	53.0	2.09
1A10MCB8	1S10MCB8		-08	74.4	2.93	48.4	1.91	11.5	0.45	60.4	2.38
1A8MCB10	1S8MCB10		-10	68.7	2.70	42.6	1.68	8.8	0.35	53.0	2.09
1A10MCB10	1S10MCB10	1G10MCB10	-10	77.9	3.07	48.5	1.91	11.5	0.45	60.4	2.38
1A10MCB10.067	1S10MCB10.067	1G10MCB10.067	-10	74.6	2.94	48.5	1.91	11.5	0.45	67.0	2.64
1A12MCB12	1S12MCB12	1G12MCB12	-12	85.6	3.37	58.5	2.30	13.9	0.55	75.7	2.98
1A16MCB16	1S16MCB16	1G16MCB16	-16	107.3	4.22	72.9	2.87	19.9	0.78	90.0	3.54

Braided series

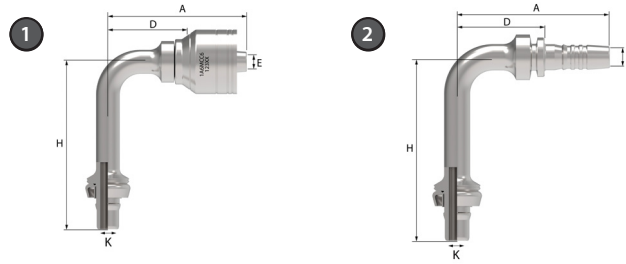

MCC

Male snap to connect (STC) 90° long drop elbow

PART		DIMENSIONS								
1	2	Hose size	A		D		K		H	
1A part #	Nipple part #		mm	in	mm	in	mm	in	mm	in
1A4MCC4		-04	49.4	1.94	29.3	1.15	4.2	0.17	61.2	2.41
1A6MCC4	1S6MCC4	-04	52.9	2.08	32.8	1.29	6.6	0.26	70.6	2.78
1A6MCC6	1S6MCC6	-06	55.3	2.18	34.0	1.34	6.6	0.26	70.6	2.78
1A6MCC8		-08	60.7	2.39	35.2	1.39	6.6	0.26	70.6	2.78
1A8MCC8	1S8MCC8	-08	67.8	2.67	42.3	1.67	8.8	0.35	88.0	3.46
1A10MCC10	1S10MCC10	-10	74.8	2.94	48.5	1.91	11.5	0.45	98.4	3.87
1A12MCC12	1S12MCC12	-12	85.6	3.37	58.5	2.30	13.9	0.55	123.7	4.87
1A16MCC16		-16	106.7	4.20	72.9	2.87	19.9	0.78	148.2	5.83

Aeroquip by Danfoss

Braided fittings

Field attachable 1R & 2R series

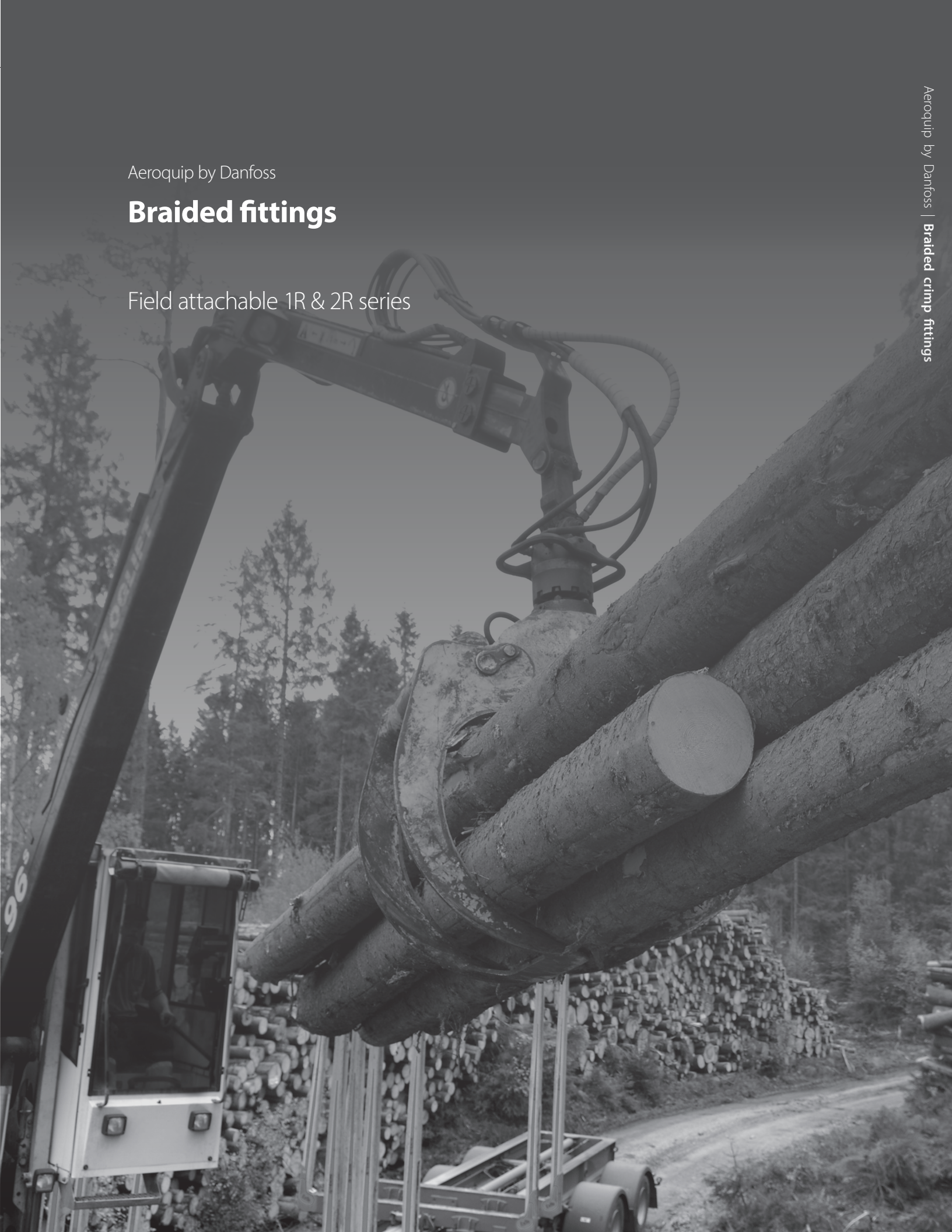

1R series

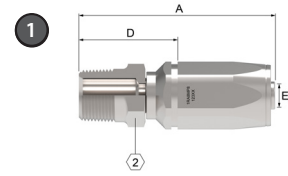

MP

Male Pipe

PART			HOSE SIZE INFO		DIMENSIONS					
1 Assy part #	Nipple/nipple assy	New field attachable socket	Thread size	Hose size	A		D		EØ	
					mm	in	mm	in	mm	in
1RA2MP4	4202-2-4S	1RA4	1/8-27	-04	55,1	2.17	28,7	1.13	4,3	0.17
1RA4MP4	4202-4-4S	1RA4	1/4-18	-04	59,9	2.36	33,5	1.32	4,3	0.17
1RA4MP6	4202-4-6S	1RA6	1/4-18	-06	68,1	2.68	39,4	1.55	7,6	0.30
1RA6MP6	4202-6-6S	1RA6	3/8-18	-06	69,8	2.75	36,9	1.45	7,9	0.31
1RA6MP8	4202-6-8S	1RA8	3/8-18	-08	71,6	2.82	34,3	1.35	9,9	0.39
1RA8MP8	4202-8-8S	1RA8	1/2-14	-08	78,0	3.07	40,6	1.60	9,9	0.39
1RA12MP12	4202-12-12S	1RA12	3/4-14	-12	90,2	3.55	49,5	1.95	15,5	0.61
1RA16MP16	4202-16-16S	1RA16	1-11 1/2	-16	108,0	4.25	54,1	2.13	20,8	0.82

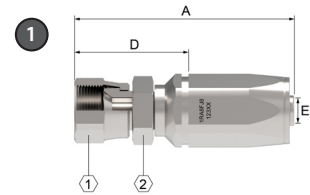

FJ

SAE 37° (JIC) swivel

PART			HOSE SIZE INFO		DIMENSIONS					
1 Assy part #	Nipple/nipple assy	New field attachable socket	Thread size	Hose size	A		D		EØ	
					mm	in	mm	in	mm	in
1RA4FJ4	4103-4-4-4S	1RA4	7/16/20	-04	63,5	2.50	37,1	1.46	4,3	0.17
1RA6FJ6	4103-4-6-6S	1RA6	9/16-18	-06	73,9	2.91	45,2	1.78	7,9	0.31
1RA8FJ8	4103-4-8-8S	1RA8	3/4-16	-08	80,8	3.18	42,8	1.68	9,9	0.39
1RA12FJ12	4103-4-12S	1RA12	1 1/16 -12	-12	96,5	3.80	55,9	2.20	15,5	0.61
1RA16FJ16	4103-4-16S	1RA16	1 5/16 -12	-16	110,0	4.33	56,1	2.21	20,8	0.82

1R series

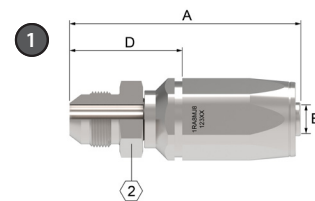

MJ

SAE 37° (JIC) male flare

PART			HOSE SIZE INFO		DIMENSIONS					
1 Assy part #	Nipple/nipple assy	New field attachable socket	Thread size	Hose size	A		D		EØ	
					mm	in	mm	in	mm	in
1RA4MJ4	4203-4-4S	1RA4	7/16-20	-04	59,4	2.34	33,0	1.30	4,3	0.17
1RA6MJ6	4203-6-6S	1RA6	9/16-18	-06	67,8	2.67	39,1	1.54	7,9	0.31
1RA8MJ8	4203-8-8S	1RA8	3/4-16	-08	75,4	2.97	37,6	1.48	9,9	0.39
1RA12MJ12	4203-12S	1RA12	1 1/16-12	-12	93,0	3.66	52,3	2.06	15,5	0.61
1RA16MJ16	4203-16S	1RA16	1 5/16-12	-16	107,4	4.23	53,3	2.10	20,8	0.82

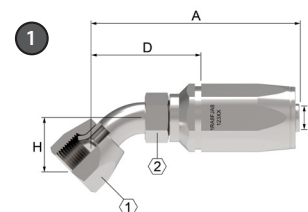

FJA

SAE 37° (JIC) swivel 45° elbow

PART			HOSE SIZE INFO		DIMENSIONS							
1 Assy part #	Nipple/nipple assy	New field attachable socket	Thread size	Hose size	A		D		EØ		DIM H	
					mm	in	mm	in	mm	in	mm	in
1RA4FJA4	185287-4S	1RA4	7/16-20	-04	60,2	2.37	33,8	1.33	4,3	0.17	8,4	0.33
1RA6FJA6	185287-6S	1RA6	9/16-18	-06	69,9	2.75	41,1	1.62	7,9	0.31	9,9	0.39
1RA8FJA8	185287-8S	1RA8	3/4-16	-08	82,3	3.24	45,0	1.77	9,9	0.39	14,0	0.55
1RA12FJA12	185287-12S	1RA12	1 1/16-12	-12	104,3	4.11	62,7	2.40	14,8	0.58	19,8	0.78
1RA16FJA16	185287-16S	1RA16	1 5/16-12	-16	124,0	4.88	69,9	2.75	20,8	0.82	27,2	1.07

1R series

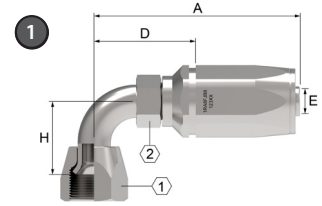

FJB

SAE 37° (JIC) swivel 90° elbow (short)

PART			HOSE SIZE INFO		DIMENSIONS							
1 Assy part #	Nipple/nipple assy	New field attachable socket	Thread size	Hose size	A		D		EØ		DIM H	
					mm	in	mm	in	mm	in	mm	in
1RA4FJB4	185264-4S	1RA4	7/16-20	-04	60,0	2.36	31,0	1.22	3,9	0.15	17,3	0.68
1RA6FJB6	185264-6S	1RA6	9/16-18	-06	67,3	2.65	38,6	1.52	7,9	0.31	21,6	0.85
1RA8FJB8	185264-8S	1RA8	3/4-16	-08	76,2	3.00	39,1	1.54	9,9	0.39	27,7	1.09
1RA12FJB12	185264-12S	1RA12	1 1/16-12	-12	102,9	4.05	62,2	2.45	15,5	0.61	46,2	1.82
1RA16FJB16	185264-16S	1RA16	1 5/16-12	-16	119,1	4.69	65,0	2.56	20,8	0.82	60,7	2.39

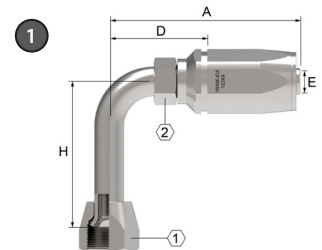

FJC

SAE 37° (JIC) swivel 90° elbow (long)

PART			HOSE SIZE INFO		DIMENSIONS							
1 Assy part #	Nipple/nipple assy	New field attachable socket	Thread size	Hose size	A		D		EØ		DIM H	
					mm	in	mm	in	mm	in	mm	in
1RA4FJC4	185263-4S	1RA4	7/16-20	-04	69,1	2.72	36,1	1.42	6,2	0.24	45,7	1.80
1RA6FJC6	185263-6S	1RA6	9/16-18	-06	67,3	2.65	38,6	1.52	7,9	0.31	55,4	2.18
1RA8FJC8	185263-8S	1RA8	3/4-16	-08	79,2	3.13	42,2	1.66	9,9	0.39	61,7	2.43
1RA12FJC12	185263-12S	1RA12	1 1/16-12	-12	102,9	4.05	62,2	2.45	15,5	0.61	94,7	3.73
1RA16FJC16	185263-16S	1RA16	1 5/16-12	-16	119,1	4.69	65,0	2.56	20,8	0.82	116,3	4.58

1R series

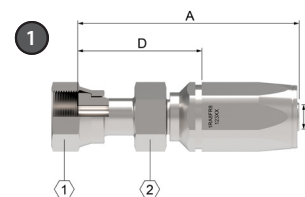

FR

ORS swivel

PART			HOSE SIZE INFO		DIMENSIONS					
1 Assy part #	Nipple/nipple assy	New field attachable socket	Thread size	Hose size	A		D		EØ	
					mm	in	mm	in	mm	in
1RA4FR4	FJ8732-0404S	1RA4	9/16/18	-04	66,5	2.62	40,1	1.58	4,1	0.16
1RA6FR6	FJ8732-0606S	1RA6	11/16-16	-06	74,9	2.95	46,2	1.82	6,6	0.26
1RA8FR8	FJ8732-0808S	1RA8	13/16-16	-08	85,9	3.38	47,9	1.89	9,6	0.38
1RA12FR12	FJ8732-1212S	1RA12	1 3/16-12	-12	101,6	4.00	60,9	2.40	14,0	0.55
1RA16FR16	FJ8732-1616S	1RA16	1 7/16-12	-16	117,9	4.64	63,8	2.51	19,8	0.78

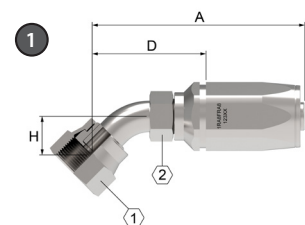

FRA

ORS swivel 45° elbow

PART			HOSE SIZE INFO		DIMENSIONS							
1 Assy part #	Nipple/nipple assy	New field attachable socket	Thread size	Hose size	A		D		EØ		DIM H	
					mm	in	mm	in	mm	in	mm	in
1RA4FRA4	FJ8733-0404S	1RA4	9/16-18	-04	63,0	2.48	40,1	1.58	4,3	0.17	10,4	0.41
1RA6FRA6	FJ8733-0606S	1RA6	11/16-16	-06	70,9	2.79	46,2	1.82	6,6	0.26	10,9	0.43
1RA8FRA8	FJ8733-0808S	1RA8	13/16-16	-08	83,3	3.28	48,5	1.91	9,7	0.38	15,0	0.59
1RA12FRA12	FJ8733-1212S	1RA12	1 3/16-12	-12	105,4	4.15	60,9	2.40	15,5	0.61	21,1	0.83
1RA16FRA16	FJ8733-1616S	1RA16	1 7/16-12	-16	124,7	4.91	72,5	2.85	19,3	0.76	24,1	0.95

1R series

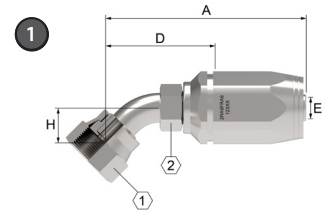

FRB

ORS swivel 90° elbow

PART			HOSE SIZE INFO		DIMENSIONS							
1 Assy part #	Nipple/nipple assy	New field attachable socket	Thread size	Hose size	A		D		EØ		DIM H	
					mm	in	mm	in	mm	in	mm	in
1RA4FRB4	FJ8734-0404S	1RA4	9/16-18	-04	58,9	2.32	32,5	1.28	4,3	0.17	20,8	0.82
1RA6FRB6	FJ8734-0606S	1RA6	11/16-16	-06	69,1	2.72	36,1	1.42	6,2	0.24	23,1	0.91
1RA8FRB8	FJ8734-0808S	1RA8	13/16-16	-08	76,5	3.01	39,1	1.54	9,7	0.38	29,2	1.15
1RA12FRB12	FJ8734-1212S	1RA12	1 3/16-12	-12	102,9	4.05	62,2	2.45	15,5	0.61	47,8	1.88
1RA16FRB16	FJ8734-1616S	1RA16	1 7/16-12	-16	119,1	4.69	65,3	2.57	20,6	0.81	56,1	2.21

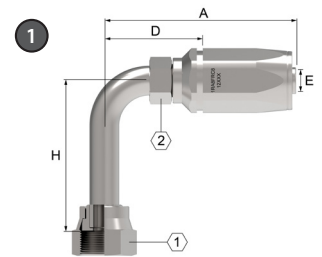

FRC

ORS swivel 90° elbow long drop

PART			HOSE SIZE INFO		DIMENSIONS							
1 Assy part #	Nipple/nipple assy	New field attachable socket	Thread size	Hose size	A		D		EØ		DIM H	
					mm	in	mm	in	mm	in	mm	in
1RA4FRC4	FJ8735-0404S	1RA4	9/16-18	-04	58.9	2.32	32.5	1.28	4.3	0.17	45.7	1.80
1RA6FRC6	FJ8735-0606S	1RA6	11/16-16	-06	70.4	2.77	41.7	1.64	6.6	0.26	54.1	2.13
1RA8FRC8	FJ8735-0808S	1RA8	13/16-16	-08	79.5	3.13	41.7	1.64	9.4	0.37	63.2	2.49
1RA12FRC12	FJ8735-1212S	1RA12	1 3/16-12	-12	102.9	4.05	62.2	2.45	15.5	0.61	96.0	3.78
1RA16FRC16	FJ8735-1616S	1RA16	1 7/16-12	-16	119.1	4.69	65.3	2.57	20.6	0.81	114.3	4.50

2R series

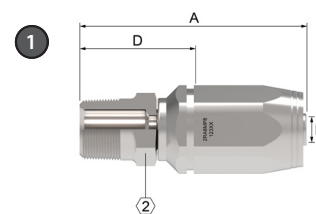

MP

Male Pipe

PART			HOSE SIZE INFO		DIMENSIONS					
1 Assy part #	Nipple/nipple assy	New field attachable socket	Thread size	Hose size	A		D		EØ	
					mm	in	mm	in	mm	in
2RA4MP4	4202-4-4S	2RA4	1/4-18	-04	63,5	2.50	33,8	1.33	4,3	0.17
2RA6MP6	4202-6-6S	2RA6	3/8-18	-06	69,9	2.75	35,8	1.41	7,9	0.31
2RA6MP8	4202-6-8S	2RA8	3/8-18	-08	72,1	2.84	34,5	1.36	9,9	0.39
2RA8MP8	4202-8-8S	2RA8	1/2-14	-08	74,5	3.09	40,1	1.58	9,9	0.39
2RA12MP12	4202-12-12S	2RA12	3/4-14	-12	91,7	3.61	44,2	1.74	15,5	0.61
2RA12MP16	4202-16-16S	2RA16	1-11 1/2	-16	111,8	4.40	59,7	2.35	20,8	0.82

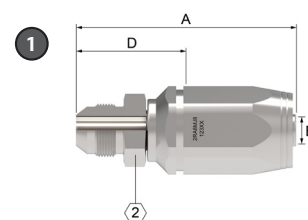

FJ

SAE 37° (JIC) swivel

PART			HOSE SIZE INFO		DIMENSIONS					
1 Assy part #	Nipple/nipple assy	New field attachable socket	Thread size	Hose size	A		D		EØ	
					mm	in	mm	in	mm	in
2RA4FJ4	4103-4-4-4S	2RA4	7/16-20	-04	63,2	2.49	33,5	1.32	4,3	0.17
2RA6FJ6	4103-4-6-6S	2RA6	9/16-18	-06	69,9	2.75	35,8	1.41	7,9	0.31
2RA8FJ8	4103-4-8-8S	2RA8	3/4-16	-08	75,9	2.99	37,6	1.48	9,9	0.39
2RA12FJ12	4103-4-12S	2RA12	1 1/16-12	-12	98,1	3.86	53,6	2.11	15,5	0.61
2RA16FJ16	4103-4-16S	2RA16	1 5/16-12	-16	111,3	4.38	59,2	2.33	20,8	0.82

2R series

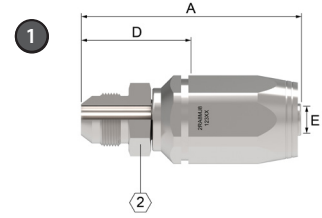

MJ

SAE 37° (JIC) male flare

PART			HOSE SIZE INFO		DIMENSIONS					
① Assy part #	Nipple/nipple assy	New field attachable socket	Thread size	Hose size	A		D		EØ	
					mm	in	mm	in	mm	in
2RA4MJ4	4203-4-4S	2RA4	7/16-20	-04	63,2	2.49	33,5	1.32	4,3	0.17
2RA6MJ6	4203-6-6S	2RA6	9/16-18	-06	69,9	2.75	37,3	1.47	7,5	0.30
2RA8MJ8	4203-8-8S	2RA8	3/4-16	-08	75,9	2.99	37,6	1.48	9,9	0.39
2RA12MJ12	4203-12S	2RA12	1 1/16-12	-12	94,5	3.72	47,0	1.85	15,5	0.61
2RA16FJA16	4203-16S	2RA16	1 5/16-12	-16	111,3	4.38	59,2	2.33	20,8	0.82

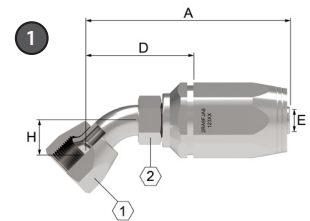

FJA

SAE 37° (JIC) swivel 45° elbow

PART			HOSE SIZE INFO		DIMENSIONS							
① Assy part #	Nipple/nipple assy	New field attachable socket	Thread size	Hose size	A		D		EØ		DIM H	
					mm	in	mm	in	mm	in	mm	in
2RA4FJA4	185287-4S	2RA4	7/16-20	-04	63,8	2.51	34,0	1.34	3,9	0.15	8,0	0.32
2RA6FJA6	185287-6S	2RA6	9/16-18	-06	71,6	2.82	37,6	1.48	7,9	0.31	9,9	0.39
2RA8FJA8	185287-8S	2RA8	3/4-16	-08	82,8	3.26	44,5	1.75	9,9	0.39	14,0	0.55
2RA12FJA12	185287-12S	2RA12	1 1/16-12	-12	105,4	4.15	57,9	2.28	15,5	0.61	19,8	0.78
2RA16FJA16	185287-16S	2RA16	1 5/16-12	-16	127,8	5.03	75,7	2.98	20,8	0.82	27,2	1.07

2R series

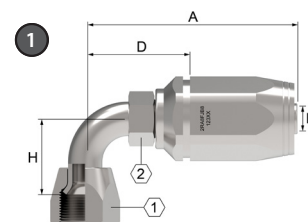

FJB

SAE 37° (JIC) swivel 90° elbow (short)

PART			HOSE SIZE INFO		DIMENSIONS							
1 Assy part #	Nipple/nipple assy	New field attachable socket	Thread size	Hose size	A		D		EØ		DIM H	
					mm	in	mm	in	mm	in	mm	in
2RA4FJB4	185264-4S	2RA4	7/16-20	-04	60,9	2.40	31,2	1.23	4,3	0.17	17,3	0.68
2RA6FJB6	185264-6S	2RA6	9/16-18	-06	69,1	2.72	35,1	1.38	7,9	0.31	21,6	0.85
2RA8FJB8	185264-8S	2RA8	3/4-16	-08	76,7	3.02	39,2	1.54	9,4	0.37	27,7	1.09
2RA12FJB12	185264-12S	2RA12	1 1/16-12	-12	104,4	4.11	56,9	2.24	15,5	0.61	46,2	1.82
2RA16FJB16	185264-16S	2RA16	1 5/16-12	-16	122,9	4.84	70,9	2.79	20,8	0.82	60,7	2.39

FJC

SAE 37° (JIC) swivel 90° elbow (long)

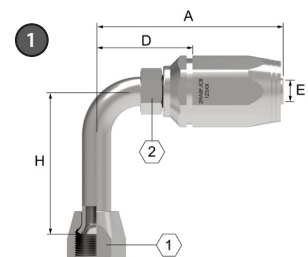

PART			HOSE SIZE INFO		DIMENSIONS							
1 Assy part #	Nipple/nipple assy	New field attachable socket	Thread size	Hose size	A		D		EØ		DIM H	
					mm	in	mm	in	mm	in	mm	in
2RA4FJC4	185263-4S	2RA4	7/16-20	-04	60,9	2.40	31,2	1.23	4,3	0.17	46,7	1.80
2RA6FJC6	185263-6S	2RA6	9/16-18	-06	69,1	2.72	36,7	1.45	6,2	0.24	55,4	2.18
2RA8FJC8	185263-8S	2RA8	3/4-16	-08	76,7	3.02	38,6	1.52	9,9	0.39	61,7	2.43
2RA12FJC12	185263-12S	2RA12	1 1/16-12	-12	104,4	4.11	56,9	2.24	15,5	0.61	94,7	3.73
2RA16FJC16	185263-16S	2RA16	1 5/16-12	-16	122,9	4.84	70,9	2.79	20,8	0.82	116,3	4.58

2R series

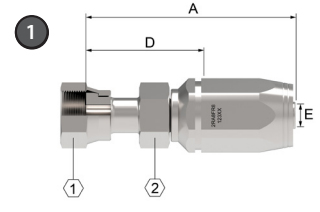

FR

ORS swivel

PART			HOSE SIZE INFO		DIMENSIONS					
1 Assy part #	Nipple/nipple assy	New field attachable socket	Thread size	Hose size	A		D		EØ	
					mm	in	mm	in	mm	in
2RA4FR4	FJ8732-0404S	2RA4	9/16-18	-04	70.1	2.76	40.3	1.59	4.1	0.16
2RA6FR6	FJ8732-0606S	2RA6	11/16-16	-06	77.0	3.03	42.9	1.69	6.6	0.26
2RA8FR8	FJ8732-0808S	2RA8	13/16-16	-08	86.4	3.40	48.7	1.92	9.6	0.38
2RA12FR12	FJ8732-1212S	2RA12	1 3/16 -12	-12	103.1	4.06	59.9	2.36	14.0	0.55
2RA16FR16	FJ8732-1616S	2RA16	1 7/16 -12	-16	121.7	4.79	69.6	2.74	19.8	0.78

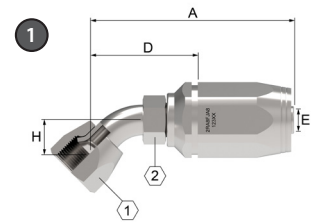

FRA

ORS 45° elbow

PART			HOSE SIZE INFO		DIMENSIONS							
1 Assy part #	Nipple/nipple assy	New field attachable socket	Thread size	Hose size	A		D		EØ		DIM H	
					mm	in	mm	in	mm	in	mm	in
2RA4FRA4	FJ8733-0404S	2RA4	9/16-18	-04	66,5	2.62	36,8	1.45	4,3	0.17	10,4	0.41
2RA6FRA6	FJ8733-0606S	2RA6	11/16-16	-06	72,9	2.87	38,9	1.53	6,6	0.26	10,9	0.43
2RA8FRA8	FJ8733-0808S	2RA8	13/16-16	-08	83,8	3.30	45,5	1.79	9,7	0.38	15,0	0.59
2RA12FRA12	FJ8733-1212S	2RA12	1 3/16 -12	-12	106,9	4.21	62,4	2.46	14,5	0.58	21,1	0.83
2RA16FRA16	FJ8733-1616S	2RA16	1 7/16 -12	-16	124,7	4.91	72,6	2.86	20,6	0.81	23,9	0.94

2R series

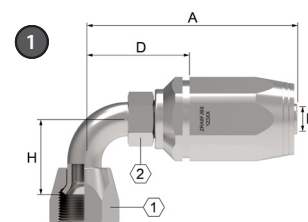

FRB

ORS swivel 90° elbow

PART			HOSE SIZE INFO		DIMENSIONS							
1 Assy part #	Nipple/nipple assy	New field attachable socket	Thread size	Hose size	A		D		EØ		DIM H	
					mm	in	mm	in	mm	in	mm	in
2RA4FRB4	FJ8734-0404S	2RA4	9/16-18	-04	62,7	2.47	33,0	1.30	4,3	0.17	20,8	0.82
2RA6FRB6	FJ8734-0606S	2RA6	11/16-16	-06	69,1	2.72	36,7	1.45	6,2	0.24	23,1	0.91
2RA8FRB8	FJ8734-0808S	2RA8	13/16-16	-08	77,0	3.03	38,6	1.52	9,7	0.38	29,2	1.15
2RA12FRB12	FJ8734-1212S	2RA12	1 3/16-12	-12	104,4	4.11	56,9	2.24	15,5	0.61	47,8	1.88
2RA16FRB16	FJ8734-1616S	2RA16	1 7/16-12	-16	122,9	4.84	70,9	2.79	20,6	0.81	56,1	2.21

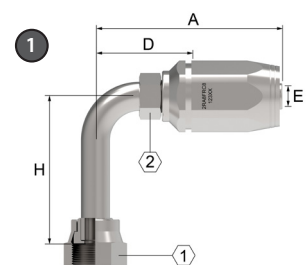

FRC

ORS Swivel

PART			HOSE SIZE INFO		DIMENSIONS							
1 Assy part #	Nipple/nipple assy	New field attachable socket	Thread size	Hose size	A		D		EØ		DIM H	
					mm	in	mm	in	mm	in	mm	in
2RA4FRC4	FJ8735-0404S	2RA4	9/16-18	-04	62,7	2.47	33,0	1.30	4,3	0.17	45,7	1.80
2RA6FRC6	FJ8735-0606S	2RA6	11/16-16	-06	69,1	2.72	35,1	1.38	6,6	0.26	54,1	2.13
2RA8FRC8	FJ8735-0808S	2RA8	13/16-16	-08	77,0	3.03	38,6	1.52	9,7	0.38	63,8	2.51
2RA12FRC12	FJ8735-1212S	2RA12	1 3/16-12	-12	104,4	4.11	59,9	2.36	14,8	0.58	96,7	3.80
2RA16FRC16	FJ8735-1616S	2RA16	1 7/16-12	-16	122,9	4.84	70,9	2.79	20,6	0.81	114,3	4.50

Aeroquip by Danfoss

Braided fittings

Field attachable Hi-Pac series



Field attachable Hi-Pac series

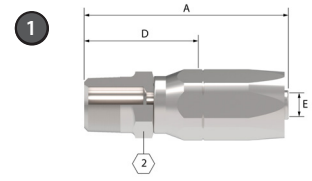

FC5131 (Hi-Pac)

Male pipe

PART	HOSE SIZE INFO		DIMENSIONS					
	Thread size	Hose size	A		D		EØ	
			mm	in	mm	in	mm	in
1 Part #								
FC5131-0404S	1/4-18	-04	62,5	2.46	31,5	1.24	4,3	0.17
FC5131-0406S	1/4-18	-06	69,9	2.75	32,5	1.28	7,9	0.31
FC5131-0606S	3/8-18	-06	69,9	2.75	32,5	1.28	7,9	0.31
FC5131-0808S	1/2-14	-08	74,5	3.09	36,6	1.44	9,9	0.39
FC5131-1212S	3/4-14	-12	91,7	3.61	44,2	1.74	15,5	0.61
FC5131-1616S	1-11 1/2	-16	111,8	4.40	58,2	2.29	20,8	0.82

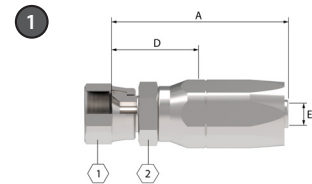

FC5130 (Hi-Pac)

SAE 37° (JIC) female

PART	HOSE SIZE INFO		DIMENSIONS					
	Thread size	Hose size	A		D		EØ	
			mm	in	mm	in	mm	in
1 Part #								
FC5130-0404S	7/16-20	-04	66,0	2.60	35,1	1.38	4,3	0.17
FC5130-0606S	9/16-18	-06	75,7	2.98	38,4	1.51	7,9	0.31
FC5130-0806S	3/4-16	-06	79,0	3.11	41,7	1.64	7,9	0.31
FC5130-0808S	3/4-16	-08	81,3	3.20	40,9	1.61	9,9	0.39
FC5130-1008S	7/8-14	-08	84,1	3.31	45,7	1.80	9,9	0.39
FC5130-1010S	7/8-14	-10	87,4	3.44	46,5	1.83	12,7	0.50
FC5130-1212S	1 1/16-12	-12	98,0	3.86	50,5	1.99	15,5	0.61
FC5130-1616S	1 5/16-12	-16	113,8	4.48	60,2	2.37	20,8	0.82

Field attachable Hi-Pac series

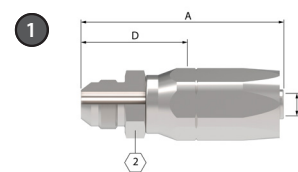

FC5133 (Hi-Pac)

SAE 37° (JIC) male flare

PART	HOSE SIZE INFO		DIMENSIONS					
	Thread size	Hose size	A		D		EØ	
1 Part #			mm	in	mm	in	mm	in
FC5133-0404S	7/16-20	-04	62,0	2.44	31,2	1.23	4,3	0.17
FC5133-0606S	9/16-18	-06	69,9	2.75	32,3	1.27	7,6	0.30
FC5133-0806S	3/4-16	-06	73,9	2.91	36,3	1.43	7,9	0.31
FC5133-0808S	3/4-16	-08	75,9	2.99	34,0	1.34	9,9	0.39
FC5133-1008S	7/8-14	-08	78,7	3.10	36,6	1.44	9,9	0.39
FC5133-1010S	7/8-14	-10	81,8	3.22	40,9	1.61	12,2	0.48
FC5133-1212S	1 1/16-12	-12	94,5	3.72	47,0	1.85	15,5	0.61
FC5133-1412S	1 3/16-12	-12	95,5	3.76	47,8	1.88	15,5	0.61
FC5133-1616S	1 5/16-12	-16	111,3	4.38	57,7	2.27	20,8	0.82

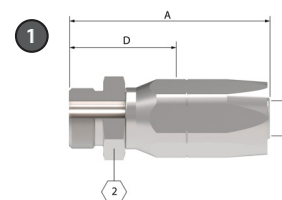

FC5379 (Hi-Pac)

SAE male o-ring boss

PART	HOSE SIZE INFO		DIMENSIONS					
	Thread size	Hose size	A		D		EØ	
1 Part #			mm	in	mm	in	mm	in
FC52379-10	7/8-14	-08	72,1	2.84	30,2	1.19	9,9	0.39
FC52379-12	9/16-12	-08	76,2	3.00	34,3	1.35	9,9	0.39
FC52379-16	1 5/16-12	-16	99,8	3.93	46,2	1.82	20,8	0.82

†O-ring not included. For flanges, split flange halves, kits and o-rings, see pages 241-247.

Field attachable Hi-Pac series

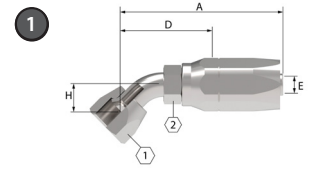

FC5144 (Hi-Pac)

SAE 37° (JIC) swivel 45° elbow

PART	HOSE SIZE INFO		DIMENSIONS							
	Thread size	Hose size	A		D		EØ		mm	in
1 Part #			mm	in	mm	in	mm	in	mm	in
FC5144-0404S	7/16-20	-04	62,7	2.47	31,8	1.25	4,3	0.17	8,4	0.33
FC5144-0606S	9/16-18	-06	71,6	2.82	34,3	1.35	7,9	0.31	9,9	0.39
FC5144-0806S	3/4-16	-06	80,5	3.17	43,8	1.70	7,9	0.31	14,0	0.55
FC5144-0808S	3/4-16	-08	83,8	3.30	43,9	1.73	9,9	0.39	14,0	0.55
FC5144-1008S	7/8-14	-08	87,6	3.45	42,2	1.66	9,9	0.39	16,3	0.64
FC5144-1010S	7/8-20	-10	89,9	3.54	50,5	1.99	12,7	0.50	16,3	0.64
FC5144-1212S	11/16-12	-12	105,4	4.15	57,9	2.28	15,5	0.61	19,8	0.78
FC5144-1616S	1 5/16-12	-16	127,8	5.03	74,2	2.92	20,8	0.82	27,2	1.07

Field attachable Hi-Pac series

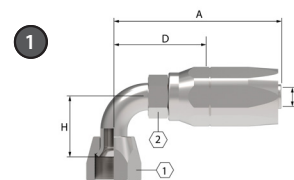

FC5143 (Hi-Pac)

SAE 37° (JIC) swivel 90° elbow short

PART	HOSE SIZE INFO		DIMENSIONS							
	Thread size	Hose size	A		D		EØ			
1 Part #			mm	in	mm	in	mm	in	mm	in
FC5143-0404S	7/16-20	-04	59,9	2.36	29,2	1.15	4,3	0.17	17,3	0.68
FC5143-0606S	9/16-18	-06	69,1	2.72	31,8	1.25	7,9	0.31	21,6	0.85
FC5143-0806S	3/4-16	-06	74,7	2.94	37,1	1.46	7,9	0.31	27,7	1.09
FC5143-0808S	3/4-16	-08	76,7	3.02	35,1	1.38	9,9	0.39	27,7	1.09
FC5143-1008S	7/8-14	-08	80,0	3.15	38,1	1.50	9,9	0.39	31,2	1.23
FC5143-1010S	7/8-14	-10	83,3	3.28	42,4	1.67	12,7	0.50	31,2	1.23
FC5143-1212S	1 1/16-12	-12	104,4	4.11	56,9	2.24	15,5	0.61	46,2	1.82
FC5143-1616S	1 5/16-12	-16	122,9	4.84	69,3	2.73	20,8	0.82	60,7	2.39

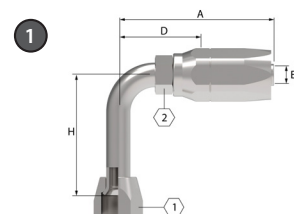

FC5142 (Hi-Pac)

SAE 37° (JIC) swivel 90° elbow long

PART	HOSE SIZE INFO		DIMENSIONS							
	Thread size	Hose size	A		D		EØ			
1 Part #			mm	in	mm	in	mm	in	mm	in
FC5142-0404S	7/16-20	-04	59,9	2.36	29,2	1.15	4,3	0.17	45,7	1.80
FC5142-0606S	9/16-18	-06	69,1	2.72	31,8	1.25	7,9	0.31	55,4	2.18
FC5142-0806S	3/4-16	-06	77,7	3.06	40,3	1.59	7,9	0.31	61,7	2.43
FC5142-0808S	3/4-16	-08	80,0	3.15	38,1	1.50	9,9	0.39	61,7	2.43
FC5142-1008S	7/8-14	-08	86,4	3.40	44,5	1.75	9,9	0.39	65,3	2.57
FC5142-010S	7/8-14	-10	89,7	3.53	48,8	1.92	12,7	0.50	65,3	2.57
FC5142-1212S	1 1/16-12	-12	104,4	4.11	56,9	2.24	15,5	0.61	94,7	3.73
FC5142-1616S	1 5/16-12	-16	122,9	4.84	69,3	2.73	20,8	0.82	116,3	4.58

Field attachable Hi-Pac series

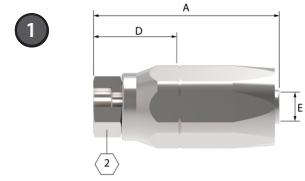

FC5380 (Hi-Pac)

Lifesaver[†]

PART	HOSE SIZE INFO		DIMENSIONS							
	Thread size	Hose size	A		B [†]		D		EØ	
1 Part #			mm	in	mm	in	mm	in	mm	in
FC5380-0404S	1/4	-04	50,5	1.99	6,4	0.25	19,6	0.77	4,3	0.17
FC5380-0606S	3/8	-06	56,4	2.22	9,7	0.38	19,1	0.75	7,9	0.31
FC5380-0808S	1/2	-08	60,9	2.40	12,7	0.50	19,1	0.75	9,9	0.39
FC5380-1010S	5/8	-10	64,3	2.53	15,7	0.62	23,4	0.92	12,7	0.50
FC5380-1212S	3/4	-12	72,6	2.86	19,1	0.75	25,1	0.99	15,5	0.61
FC5380-1616S	1	-16	84,8	3.34	25,4	1.00	31,2	1.23	20,8	0.82

[†]"B" dimension is counterbore diameter for mating tubing.

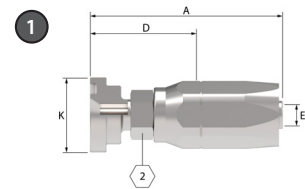

FC5135 (Hi-Pac)

Code 61 SAE J518 straight split flange

PART	HOSE SIZE INFO		DIMENSIONS							
	Hose size	Flange head dia.	A		D		EØ			
1 Part #			mm	in	mm	in	mm	in	mm	in
FC5135-0808S	-08	30,2	1.19	77,0	3.03	35,1	1.38	9,9	0.39	
FC5135-1208S	-08	38,1	1.50	78,0	3.07	36,1	1.42	9,9	0.39	
FC5135-1212S	-12	38,1	1.50	89,7	3.53	42,2	1.66	15,5	0.61	
FC5135-1612S	-12	44,5	1.75	99,6	3.92	52,1	2.05	15,5	0.61	
FC5135-616S	-16	44,5	1.75	118,1	4.65	64,5	2.54	20,8	0.82	
FC5135-2016S	-16	50,8	2.00	118,1	4.65	64,5	2.54	20,8	0.82	

Field attachable Hi-Pac series

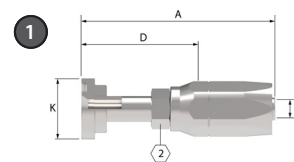

FC5136 (Hi-Pac)

Code 61 SAE J518 22 1/2" split flange

PART ① Part #	HOSE SIZE INFO		DIMENSIONS								
	Hose size	Flange head dia.		A		D		EØ		H	
		mm	in	mm	in	mm	in	mm	in	mm	in
FC5136-0808S	-08	30,2	1.19	95,5	3.76	53,6	2.11	9,9	0.39	12,7	0.50
FC5136-1212S	-12	38,1	1.50	109,7	4.32	62,0	2.44	15,5	0.61	12,7	0.50
FC5136-1612S	-12	44,5	1.75	109,7	4.32	62,0	2.44	15,5	0.61	12,7	0.50
FC5136-1616S	-16	44,5	1.75	122,9	4.84	69,3	2.73	20,8	0.82	12,7	0.50
FC5136-2016S	-16	50,8	2.00	122,9	4.84	69,3	2.73	20,8	0.82	12,7	0.50

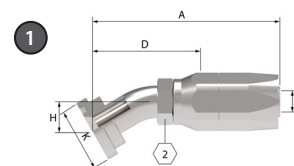

FC5137 (Hi-Pac)

Code 61 SAE J518 30" split flange

PART ① Part #	HOSE SIZE INFO		DIMENSIONS								
	Hose size	Flange head dia.		A		D		EØ		H	
		mm	in	mm	in	mm	in	mm	in	mm	in
FC5137-1212S	-12	38,1	4.38	111,3	4.38	63,8	2.51	15,5	0.61	17,5	0.69
FC5137-1612S	-12	44,5	4.38	111,3	4.38	63,8	2.51	15,5	0.61	17,5	0.69
FC5137-1616S	-16	44,5	4.61	117,1	4.61	63,5	2.50	20,8	0.82	12,7	0.50
FC5137-2016S	-16	50,8	4.61	117,1	4.61	63,5	2.50	20,8	0.82	12,7	0.50

Field attachable Hi-Pac series

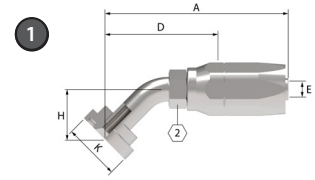

FC5138 (Hi-Pac)

Code 61 SAE J518 45° split flange

PART	HOSE SIZE INFO		DIMENSIONS								
	Part #	Hose size	Flange head dia.		A		D		EØ		H
		mm	in	mm	in	mm	in	mm	in	mm	in
FC5138-0808S	-08	30,2	1.19	94,2	3.71	52,3	2.06	9,9	0.39	25,4	1.00
FC5138-1212S	-12	38,1	1.50	110,2	4.34	62,7	2.47	15,5	0.61	25,4	1.00
FC5138-1612S	-12	44,5	1.75	111,5	4.39	64,0	2.52	15,5	0.61	25,4	1.00
FC5138-1616S	-16	44,5	1.75	129,3	5.09	75,7	2.98	20,8	0.82	28,4	1.12
FC5138-2016S	-16	50,8	2.00	129,3	5.09	75,7	2.98	20,8	0.82	28,4	1.12

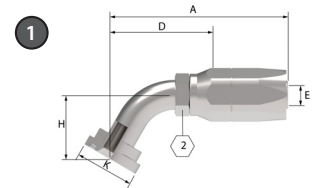

FC5139 (Hi-Pac)

Code 61 SAE J518 60° split flange

PART	HOSE SIZE INFO		DIMENSIONS								
	Part #	Hose size	Flange head dia.		A		D		EØ		H
		mm	in	mm	in	mm	in	mm	in	mm	in
FC5139-1212S	-12	38,1	1.50	114,8	4.52	67,3	2.65	15,5	0.61	41,1	1.62
FC5139-1612S	-12	44,5	1.75	114,8	4.52	67,3	2.65	15,5	0.61	41,1	1.62
FC5139-1616S	-16	44,5	1.75	130,8	5.15	77,2	3.04	20,8	0.82	41,7	1.64
FC5139-2016S	-16	50,8	2.00	130,8	5.15	77,2	3.04	20,8	0.82	41,7	1.64

Field attachable Hi-Pac series

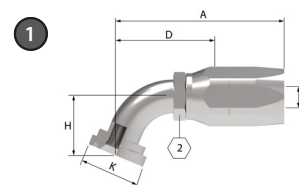

FC5140 (Hi-Pac)

Code 61 SAE J518 67 1/2" split flange

PART 1 Part #	HOSE SIZE INFO		DIMENSIONS								
	Hose size	Flange head dia.	A		D		EØ		H		
		mm	in	mm	in	mm	in	mm	in	mm	in
FC5140-0808S	-08	30,2	1.19	88,1	3.47	46,2	1.82	9,9	0.39	35,1	1.38
FC5140-1212S	-12	38,1	1.50	111,0	4.37	63,5	2.50	15,5	0.61	41,1	1.62
FC5140-1612S	-12	44,5	1.75	111,0	4.37	63,5	2.50	15,5	0.61	41,1	1.62
FC5140-1616S	-16	44,5	1.75	128,7	5.07	75,2	2.96	20,8	0.82	44,5	1.75
FC5140-2016S	-16	50,8	2.00	128,7	5.07	75,2	2.96	20,8	0.82	44,5	1.75

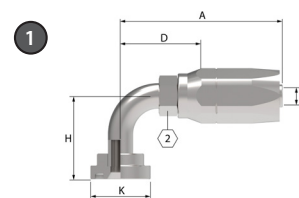

FC5141 (Hi-Pac)

Code 61 SAE J518 90° split flange

PART 1 Part #	HOSE SIZE INFO		DIMENSIONS								
	Hose size	Flange head dia.	A		D		EØ		H		
		mm	in	mm	in	mm	in	mm	in	mm	in
FC5141-0808S	-08	30,2	1.19	80,0	3.15	38,1	1.50	9,9	0.39	41,1	1.62
FC5141-1208S	-08	38,1	1.50	80,0	3.15	38,1	1.50	9,9	0.39	41,1	1.62
FC5141-1212S	-12	38,1	1.50	104,4	4.11	56,9	2.24	15,5	0.61	53,8	2.12
FC5141-1612S	-12	44,5	1.75	104,4	4.11	56,9	2.24	15,5	0.61	53,8	2.12
FC5141-1616S	-16	44,5	1.75	122,9	4.84	69,3	2.73	20,8	0.82	60,5	2.38
FC5141-2016S	-16	50,8	2.00	122,9	4.84	69,3	2.73	20,8	0.82	60,5	2.38

NOTE: For correct socket part number, see page I-3.
For flanges, split flange halves, kits and o-rings, see pages 241-247.

Field attachable Hi-Pac series

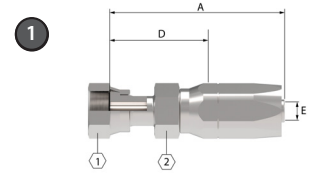

FJ9728 (Hi-Pac)

ORS swivel straight

PART	HOSE SIZE INFO		DIMENSIONS					
	Hose size	Flange head dia	A		D		EØ	
			mm	in	mm	in	mm	in
FJ9728-0404S	-04	9/16-18	68,8	2.71	38,1	1.50	4,3	0.17
FJ9728-0606S	-06	11/16-16	76,7	3.02	39,4	1.55	6,6	0.26
FJ9728-0808S	-08	13/16-16	86,4	3.40	44,5	1.75	9,9	0.39
FJ9728-1010S	-10	1-14	91,9	3.62	51,1	2.01	12,7	0.50
FJ9728-1212S	-12	1 3/16-12	102,9	4.05	55,4	2.18	15,5	0.61
FJ9728-1616S	-16	1 7/16-12	121,4	4.78	68,1	2.68	20,8	0.82

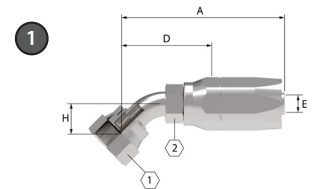

FJ9729 (Hi-Pac)

ORS swivel 45° elbow

PART	HOSE SIZE INFO		DIMENSIONS							
	Hose size	Flange head dia	A		D		EØ		H	
			mm	in	mm	in	mm	in	mm	in
FJ9729-0404S	-04	9/16-18	65,5	2.58	34,5	1.36	3,8	0.15	10,4	0.41
FJ9729-0606S	-06	11/16-16	72,6	2.86	35,3	1.39	6,1	0.24	10,9	0.43
FJ9729-0808S	-08	13/16-16	83,8	3.30	41,9	1.65	9,4	0.37	15,0	0.59
FJ9729-1010S	-10	1-14	91,9	3.62	51,1	2.01	11,7	0.46	16,5	0.65
FJ9729-1212S	-12	1 3/16-12	106,9	4.21	59,4	2.34	14,7	0.58	21,1	0.83
FJ9729-1616S	-16	1 7/16-12	124,7	4.91	71,1	2.80	19,3	0.76	23,9	0.94

Field attachable Hi-Pac series

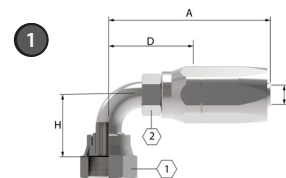

FJ8730 (Hi-Pac)

ORS swivel 90° elbow short drop

PART	HOSE SIZE INFO		DIMENSIONS							
	Part #	Hose size	Flange head dia	A		D		EØ		H
			mm	in	mm	in	mm	in	mm	in
FJ9730-0404S	-04	9/16-18	61,5	2.42	30,7	1.21	3,8	0.15	20,8	0.82
FJ9730-0606S	-06	11/16-16	69,1	2.72	31,8	1.25	6,1	0.24	22,9	0.90
FJ9730-0808S	-08	13/16-16	76,7	3.02	35,1	1.38	9,4	0.37	29,2	1.15
FJ9730-1010S	-10	1-14	83,3	3.28	42,4	1.67	11,7	0.46	32,3	1.27
FJ9730-1212S	-12	1 3/16-12	104,4	4.11	56,9	2.24	14,7	0.58	47,8	1.88
FJ9730-1616S	-16	1 7/16-12	122,9	4.84	69,3	2.73	19,3	0.76	56,1	2.21

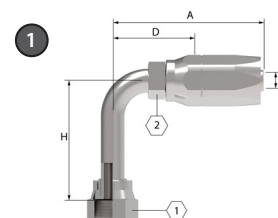

FJ9731 (Hi-Pac)

ORS swivel 90° elbow long drop

PART	HOSE SIZE INFO		DIMENSIONS							
	Part #	Hose size	Flange head dia	A		D		EØ		H
			mm	in	mm	in	mm	in	mm	in
FJ9731-0404S	-04	9/16-18	61,5	2.42	30,7	1.21	3,8	0.15	45,7	1.80
FJ9731-0606S	-06	11/16-16	72,4	2.85	34,8	1.37	6,1	0.24	54,1	2.13
FJ9731-0808S	-08	13/16-16	80,0	3.15	38,1	1.50	9,4	0.37	63,8	2.51
FJ9731-1010S	-10	1-14	83,3	3.28	42,4	1.67	11,7	0.46	70,1	2.76
FJ9731-1212S	-12	1 3/16-12	104,4	4.11	56,9	2.24	14,7	0.58	96,0	3.78
FJ9731-1616S	-16	1 7/16-12	122,9	4.84	69,3	2.73	19,3	0.76	114,3	4.50

Field attachable Hi-Pac series

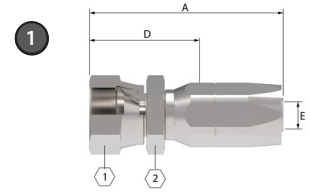

FJ7201 (Hi-Pac)

30° swivel-metric threads special komatsu

PART		HOSE SIZE INFO		DIMENSIONS					
1 Part #	Hose size	Thread	A		D		EØ		
			mm	in	mm	in	mm	in	
FJ7201-0306S	-06	M18x1.5	79,0	3.11	41,7	1.64	6,4	0.25	
FJ7201-0408S	-08	M22x1.5	84,3	3.32	42,2	1.66	9,4	0.37	
FJ7201-0510S	-10	M24x1.5	90,9	3.58	50,0	1.97	12,7	0.50	
FJ7201-0612S	-12	M30x1.5	103,6	4.08	56,4	2.22	15,5	0.61	
FJ7201-1016S	-16	M33x1.5	123,4	4.86	70,1	2.76	20,3	0.80	

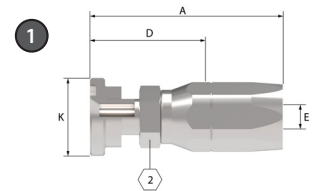

FJ7202 (Hi-Pac)

Komatsu split flange

PART		HOSE SIZE INFO		DIMENSIONS					
1 Part #	Hose size	Thread	A		D		EØ		
			mm	in	mm	in	mm	in	
FJ7202-1010S	-10	34,3	1.35	114,8	4.52	73,9	2.91	11,7	0.46

Field attachable Hi-Pac series

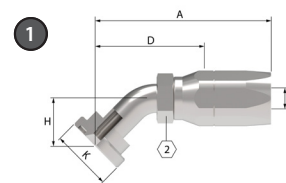

FJ7203 (Hi-Pac)

Komatsu split flange 45° elbow

PART	HOSE SIZE INFO			DIMENSIONS							
	Part #	Hose size	Thread		A		D		EØ		H
mm			in	mm	in	mm	in	mm	in	mm	in
FJ7203-1010S	-10	34,3	1.35	96,5	3.80	55,6	2.19	11,7	0.46	21,8	0.86

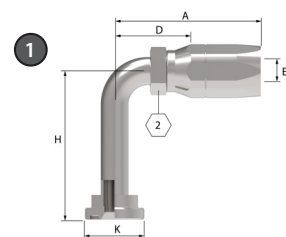

FJ7204 (Hi-Pac)

Komatsu split flange 90° elbow

PART	HOSE SIZE INFO			DIMENSIONS							
	Part #	Hose size	Thread		A		D		EØ		H
mm			in	mm	in	mm	in	mm	in	mm	in
FJ7204-1010S	-10	34,3	1.35	89,7	3.53	48,8	1.92	11,7	0.46	76,7	3.02

Winner by Danfoss

Braided fittings

Winner standard series



Winner

Ordering information

Winner standard crimp fittings

26711 D-04-04 SM W ZF

Fitting series

Material stock code

A = Large hex stock

D = Hex stock female nipple

If material is round stock position collapses

Terminal end size

Hose size

Special suffix code

SM = Backup hex smaller than swivel hex

SP = BSPT with 60° cone

HXX = Special drop length, XX is the drop length in mm

If no special design is required, position collapses

Nut design

T = Captive nut

W = Wire nut

If crimp nut is used or if nut is not required, position collapses

Plating type code

ZF = Zinc Trivalent Chromate (Cr3)

Braided – standard fittings

00110

Crimp Socket 1 wire For use with hose: EC115 and EC118

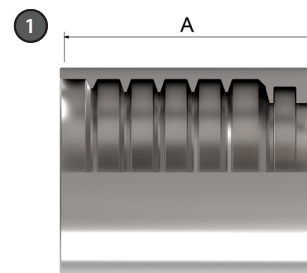

PART #	HOSE SIZE INFO		DIMENSIONS				WEIGHT	
1 Part #	DN	Dash Size	A		OD		Weight	
			mm	in	mm	in	kg	lb
00110-04ANZF	6	-04	27,5	1.08	21.0	0.83	0.03	0.07
00110-06ANZF	10	-06	30,0	1.18	24.3	0.96	0.04	0.08
00110-08ANZF	12	-08	34,0	1.34	28.0	1.10	0.05	0.10
00110-10ANZF	16	-10	37,0	1.46	31.3	1.23	0.06	0.13
00110-12ANZF	20	-12	42,0	1.65	28.7	1.13	0.08	0.17
00110-16ANZF	25	-16	51,0	2.01	43.5	1.71	0.13	0.28

03310

Crimp Socket 2 wire For use with hose: EC215 and WH004

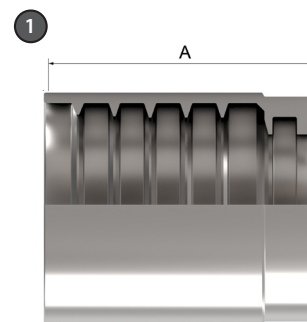

PART #	HOSE SIZE INFO		DIMENSIONS				WEIGHT	
1 Part #	DN	Dash Size	A		OD		Weight	
			mm	in	mm	in	kg	lb
03310-04NZF	6	-04	30.5	1.20	23.0	0.91	0.04	0.09
03310-06NZF	10	-06	32.0	1.26	26.0	1.02	0.04	0.09
03310-08NZF	12	-08	34.0	1.34	29.0	1.14	0.05	0.10
03310-10ANZF	16	-10	35.0	1.38	34.5	1.36	0.06	0.14
03310-12NZF	20	-12	42.0	1.65	37.0	1.46	0.08	0.18
03310-16NZF	25	-16	52.0	2.05	46.7	1.84	0.15	0.33

Winner

Braided – standard fittings

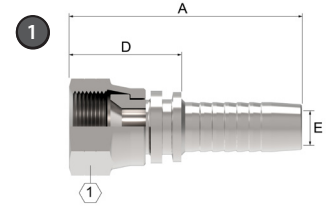

26711

Female JIC/SAE 37° Swivel For use with hose: EC115, EC215 and EC118

PART	HOSE SIZE INFO				DIMENSIONS							WEIGHT	
	Terminal End	Thread	Hose Size		A		D Cut Off Factor		E Ø		⊕	Weight	
① Part #	Dash Size		DN	Dash Size	mm	in	mm	in	mm	in	mm	kg	lb
26711-04-04ZF	-04	7/16"-20	6	-04	43.0	1.69	15.0	0.59	4.0	0.16	14	0.020	0.044
26711-06-04ZF	-06	9/16"-18	6	-04	43.5	1.71	15.5	0.61	4.0	0.16	19	0.032	0.071
26711-06-06ZF	-06	9/16"-18	10	-06	45.5	1.79	15.5	0.61	7.0	0.28	19	0.037	0.082
26711-08-06ZF	-08	3/4"-16	10	-06	47.5	1.87	17.5	0.69	7.0	0.28	22	0.054	0.119
26711-08-08ZF	-08	3/4"-16	12	-08	50.0	1.97	18.5	0.73	9.9	0.39	22	0.060	0.132
26711-10-08ZF	-10	7/8"-14	12	-08	50.5	1.99	19.0	0.75	10.0	0.39	27	0.090	0.198
26711-10-10ZF	-10	7/8"-14	16	-10	53.5	2.11	19.5	0.77	12.0	0.47	27	0.100	0.220
26711-12-12ZF	-12	1 1/16"-12	20	-12	60.0	2.36	21.5	0.85	15.0	0.59	32	0.130	0.287
26711-16-16ZF	-16	1 5/16"-12	25	-16	70.0	2.76	23.0	0.91	21.0	0.83	41	0.210	0.463

Braided – standard fittings

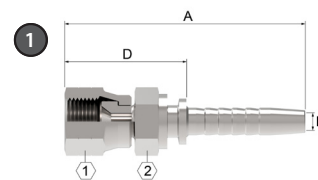

26711D

Female JIC/SAE 37° Swivel* For use with hose: EC115, EC215 and EC118

PART	HOSE SIZE INFO				DIMENSIONS								WEIGHT	
	Terminal End	Thread	Hose Size		A		D Cut Off Factor		E Ø		1	2	Weight	
1 Part #	Dash Size		DN	Dash Size	mm	in	mm	in	mm	in	mm	mm	kg	lb
26711D-04-04ZF	-04	7/16"-20	6	-04	57.0	2.24	29.0	1.14	4.0	0.16	14	14	0.03	0.07
26711D-06-04ZF	-06	9/16"-18	6	-04	59.0	2.32	31.0	1.22	3.9	0.15	19	19	0.04	0.10
26711D-06-06ZF	-06	9/16"-18	10	-06	61.0	2.40	31.0	1.22	6.9	0.27	19	19	0.05	0.10
26711D-08-06ZF	-08	3/4"-16	10	-06	66.0	2.60	36.0	1.42	6.9	0.27	22	22	0.08	0.18
26711D-08-08ZF	-08	3/4"-16	12	-08	67.0	2.64	35.5	1.40	9.8	0.38	22	22	0.08	0.17
26711D-10-08ZF	-10	7/8"-14	12	-08	70.5	2.78	39.0	1.54	9.9	0.39	27	27	0.10	0.23
26711D-10-10ZF	-10	7/8"-14	16	-10	61.0	2.40	27.0	1.06	12.0	0.47	27	27	0.12	0.26
26711D-12-10ZF	-12	1 1/16"-12	16	-10	79.5	3.13	45.5	1.79	11.9	0.47	32	32	0.18	0.39
26711D-12-12ZF	-12	1 1/16"-12	20	-12	84.5	3.33	46.0	1.81	14.9	0.59	32	32	0.19	0.41
26711D-12-16ZF	-12	1 3/16"-12	25	-16	95.0	3.74	48.0	1.89	20.9	0.82	32	36	0.23	0.50
26711D-16-12ZF	-16	1 5/16"-12	20	-12	86.6	3.41	48.1	1.89	14.9	0.59	41	41	0.30	0.65
26711D-16-16ZF	-16	1 5/16"-12	25	-16	96.7	3.81	49.7	1.96	20.9	0.82	41	41	0.32	0.71

Winner

Braided – standard fittings

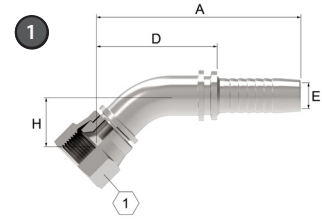

26741

Female JIC/SAE 37° Swivel 45° Elbow For use with hose: EC115, EC215 and EC118

PART	HOSE SIZE INFO				DIMENSIONS								WEIGHT		
	Terminal End	Thread	Hose Size		A		D Cut Off Factor		E Ø		H		1	Weight	
1 Part #	Dash Size		DN	Dash Size	mm	in	mm	in	mm	in	mm	in	mm	kg	lb
26741-04-04ZF	-04	7/16"-20	6	-04	63.1	2.48	35.1	1.38	4.0	0.16	13.0	0.51	14	0.035	0.077
26741-06-06ZF	-06	9/16"-18	10	-06	68.8	2.71	38.8	1.53	7.0	0.28	14.8	0.58	19	0.062	0.137
26741-08-08ZF	-08	3/4"-16	12	-08	76.8	3.02	45.3	1.78	10.0	0.39	19.0	0.75	22	0.105	0.231
26741-10-10ZF	-10	7/8"-14	16	-10	88.4	3.48	54.4	2.14	12.0	0.47	22.1	0.87	27	0.146	0.322
26741-12-12ZF	-12	1 1/16"-12	20	-12	97.8	3.85	59.3	2.33	15.0	0.59	24.2	0.95	32	0.240	0.529
26741-16-16ZF	-16	1 5/16"-12	25	-16	121.3	4.78	74.3	2.93	21.0	0.83	28.7	1.13	41	0.400	0.882
26741-04-04H10ZF	-04	7/16"-12	6	-04	59.0	2.32	31.0	1.22	3.9	0.15	10.0	0.39	14	0.01	0.01
26741-06-04H11ZF	-06	9/6"-18	6	-04	60.0	2.36	3.02	1.26	3.9	0.15	11.0	0.43	19	0.01	0.02
26741-06-06H11ZF	-06	9/6"-18	10	-06	65.7	2.59	35.7	1.41	6.9	0.27	11.0	0.43	19	0.05	0.11
26741-08-06TZF	-08	3/4"-16	10	-06	70.4	2.77	40.4	1.59	6.9	0.27	15.0	0.59	22	0.07	0.15
26741-08-08H15ZF	-08	3/4"-16	12	-08	78.9	3.11	47.4	1.87	9.9	0.39	15.0	0.59	22	0.07	0.16
26741-10-10H16ZF	-10	7/8"-14	16	-10	87.4	3.44	53.4	2.10	11.9	0.47	16.0	0.63	27	0.12	0.26
26741-12-12H21ZF	-12	1 1/16"-12	20	-12	95.4	3.76	56.9	2.24	14.9	0.59	21.0	0.83	32	0.19	0.42
26741-16-16H24ZF	-16	1 5/16"-12	25	-16	119.47	4.7	72.47	2.85	20.9	0.82	24.0	0.94	41	0.36	0.80

Braided – standard fittings

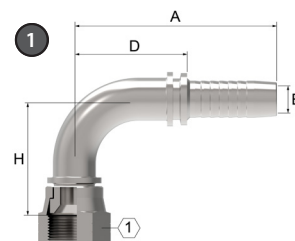

26791

Female JIC/SAE 37° Swivel 90° Elbow For use with hose: EC115, EC215 and EC118

PART ① Part #	HOSE SIZE INFO				DIMENSIONS									WEIGHT	
	Terminal End	Thread	Hose Size		A		D Cut Off Factor		E Ø		H		① Weight		
	Dash Size		DN	Dash Size	mm	in	mm	in	mm	in	mm	in	mm	kg	lb
26791-04-04ZF	-04	7/16"-20	6	-04	58.0	2.28	30.0	1.18	4.0	0.16	26.3	1.04	14	0.040	0.088
26791-06-04ZF	-06	9/16"-18	6	-04	58.0	2.28	30.0	1.18	4.0	0.16	27.0	1.06	19	0.048	0.106
26791-06-06ZF	-06	9/16"-18	10	-06	64.5	2.54	34.5	1.36	7.0	0.28	31.5	1.24	19	0.070	0.154
26791-08-08ZF	-08	3/4"-16	12	-08	71.0	2.80	39.5	1.56	10.0	0.39	40.0	1.57	22	0.118	0.260
26791-10-08ZF	-10	7/8"-14	12	-08	71.0	2.80	39.5	1.56	10.0	0.39	42.0	1.65	27	0.132	0.291
26791-10-10ZF	-10	7/8"-14	16	-10	83.0	3.27	49.0	1.93	12.0	0.47	47.5	1.87	27	0.190	0.419
26791-12-12ZF	-12	1 1/16"-12	20	-12	93.0	3.66	54.5	2.15	15.0	0.59	53.5	2.11	32	0.300	0.661
26791-16-16ZF	-16	1 5/16"-12	25	-16	118.0	4.65	71.0	2.80	21.0	0.83	66.1	2.60	41	0.460	1.014
26791-04-04H21ZF	-04	7/16"-20	6	-04	55.3	2.18	27.3	1.07	3.9	0.15	21.0	0.83	14	0.03	0.06
26791-06-04H23ZF	-06	9/16"-18	6	-04	55.3	2.18	27.3	1.07	3.9	0.15	23.0	0.91	19	0.04	0.09
26791-06-06H23ZF	-06	9/16"-18	10	-06	61.8	2.43	31.8	1.25	6.9	0.27	23.0	0.91	19	0.05	0.11
26791-06-06H54ZF	-06	9/16"-18	10	-06	64.5	2.54	34.5	1.36	6.9	0.27	54.0	2.13	19	0.08	0.17
26791-08-06H29ZF	-08	3/4"-16	10	-06	68.5	2.7	38.5	1.52	6.9	0.27	29.0	1.14	22	0.08	0.17
26791-08-08H29ZF	-08	3/4"-16	12	-08	78.5	3.09	47.0	1.85	9.9	0.39	29.0	1.14	22	0.08	0.18
26791-10-08H32ZF	-10	7/8"-14	12	-08	76.0	2.99	44.5	1.75	9.9	0.39	32.0	1.26	27	0.11	0.25
26791-10-10H32ZF	-10	7/8"-14	16	-10	83.5	3.29	49.5	1.95	11.9	0.47	32.0	1.26	27	0.12	0.27
26791-12-10H48ZF	-12	1 1/16"-12	16	-10	83.0	3.27	49.0	1.93	11.9	0.47	48.0	1.89	32	0.21	0.46
26791-12-10H96ZF	-12	1 1/16"-12	16	-10	83.0	3.27	49.0	1.93	12.0	0.47	96.0	3.78	32	0.26	0.58
26791-12-12H48ZF	-12	1 1/16"-12	20	-12	92.8	3.65	54.3	2.14	14.9	0.59	48.0	1.89	32	0.22	0.49
26791-12-12H96ZF	-12	1 1/16"-12	20	-12	93.0	3.66	54.5	2.15	14.9	0.59	96.0	3.78	32	0.33	0.72
26791-16-16H56ZF	-16	1 5/16"-12	25	-16	118.3	4.66	71.3	2.81	20.9	0.82	56.0	2.2	41	0.48	1.06

Winner

Braided – standard fittings

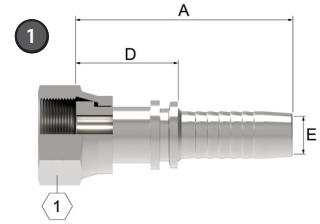

24211

Female ORS Swivel For use with hose: EC115, EC215 and EC118

PART		HOSE SIZE INFO				DIMENSIONS						WEIGHT	
① Part #	Terminal End	Thread	Hose Size		A		D Cut Off Factor		E Ø		①	Weight	
	Dash Size		DN	Dash Size	mm	in	mm	in	mm	in	mm	kg	lb
24211-04-04ZF	-04	9/16"×18	6	-04	50.5	1.99	22.5	0.89	4.0	0.16	17	0.034	0.075
24211-06-06ZF	-06	11/16"×16	10	-06	55.5	2.19	25.5	1.00	7.0	0.28	22	0.055	0.121
24211-08-08ZF	-08	13/16"×16	12	-08	59.5	2.34	28.0	1.10	10.0	0.39	27	0.086	0.190
24211-10-10ZF	-10	1"×14	16	-10	67.0	2.64	33.0	1.30	12.0	0.47	30	0.120	0.265
24211-12-12ZF	-12	1 3/16"×12	20	-12	73.5	2.89	35.0	1.38	15.0	0.59	36	0.195	0.430
24211-16-16TZF	-16	1 7/16"×12	25	-16	82.0	3.23	35.0	1.38	21.0	0.83	41	0.260	0.573

Braided – standard fittings

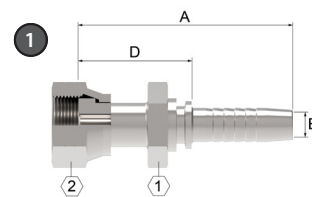

24211D

Female ORS Swivel* For use with hose: EC115, EC215 and EC118

PART	HOSE SIZE INFO				DIMENSIONS								WEIGHT	
	Terminal End	Thread	Hose Size		A		D Cut Off Factor		E Ø		1	2	Weight	
			Dash size	DN	Dash Size	mm	in	mm	in	mm	in	mm	mm	kg
24211D-04-04ZF	-04	9/16"-18	6	-04	56.0	2.20	28.0	1.10	4.00	0.16	19	17	0.04	0.09
24211D-06-04ZF	-06	11/16"-16	6	-04	60.5	2.38	32.5	1.28	4.00	0.16	22	22	0.07	0.15
24211D-06-06ZF	-06	11/16"-16	10	-06	63.5	2.50	33.5	1.32	7.00	0.28	22	22	0.08	0.17
24211D-06-08ZF	-06	11/16"-16	12	-08	65.5	2.58	34.0	1.34	10.0	0.39	22	22	0.09	0.19
24211D-08-06ZF	-08	13/16"-16	10	-06	65.5	2.58	35.5	1.40	7.00	0.28	24	24	0.11	0.24
24211D-08-08ZF	-08	13/16"-16	12	-08	67.5	2.66	36.0	1.42	10.0	0.39	24	24	0.11	0.24
24211D-08-10ZF	-08	13/16"-16	16	-10	71.0	2.80	37.0	1.46	11.9	0.47	24	24	0.13	0.29
24211D-10-08SMZF	-10	1"-14	12	-08	70.0	2.76	38.5	1.52	10.0	0.39	24	30	0.14	0.30
24211D-10-08ZF	-10	1"-14	12	-08	72.5	2.85	41.0	1.61	9.90	0.39	30	30	0.17	0.36
24211D-10-10SMZF	-10	1"-14	16	-10	74.0	2.91	39.0	1.54	11.5	0.45	24	30	0.16	0.35
24211D-10-10ZF	-10	1"-14	16	-10	76.0	2.99	42.0	1.65	11.9	0.47	30	30	0.18	0.39
24211D-10-12ZF	-10	1"-14	20	-12	81.5	3.21	43.0	1.69	15.0	0.59	30	30	0.20	0.44
24211D-12-08ZF	-12	1 3/16"-12	12	-08	75.8	2.98	44.3	1.74	9.90	0.39	36	36	0.25	0.56
24211D-12-10ZF	-12	1 3/16"-12	16	-10	79.5	3.13	45.5	1.79	11.9	0.47	36	36	0.26	0.56
24211D-12-12ZF	-12	1 3/16"-12	20	-12	84.0	3.31	45.5	1.79	14.9	0.59	36	36	0.26	0.58
24211D-12-16ZF	-12	1 3/16"-12	25	-16	93.5	3.68	46.5	1.83	20.9	0.82	36	36	0.29	0.65
24211D-16-12ZF	-16	1 7/16"-12	20	-12	86.5	3.41	48.0	1.89	14.9	0.59	41	41	0.33	0.73
24211D-16-16ZF	-16	1 7/16"-12	25	-16	96.0	3.78	49.0	1.93	20.9	0.82	41	41	0.36	0.78

Winner

Braided – standard fittings

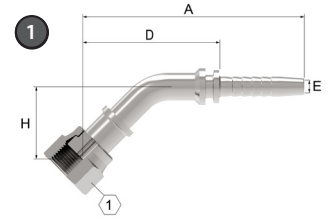

24241

Female ORS Swivel 45° Elbow For use with hose: EC115, EC215 and EC118

PART	HOSE SIZE INFO				DIMENSIONS								WEIGHT		
	Terminal End	Thread	Hose Size		A		D Cut Off Factor		E Ø		H		1	Weight	
1 Part #	Dash size		DN	Dash Size	mm	in	mm	in	mm	in	mm	in	mm	kg	lb
24241-04-04H10ZF	-04	9/16"-18	6	-04	59.5	2.34	34.5	1.36	3.9	0.15	10	0.39	17	0.03	0.07
24241-04-06H10ZF	-04	9/16"-18	10	-06	66.9	2.63	36.9	1.45	7.0	0.28	10	0.39	17	0.04	0.09
24241-06-04H11TZF	-06	11/16"-16	6	-04	63.5	2.50	35.5	1.40	3.9	0.15	11	0.43	22	0.06	0.13
24241-06-06H11ZF	-06	11/16"-16	10	-06	64.9	2.56	34.9	1.37	7.0	0.28	11	0.43	22	0.06	0.12
24241-08-06H15TZF	-08	13/16"-16	10	-06	71.3	2.81	41.3	1.63	6.9	0.27	15	0.59	24	0.08	0.17
24241-08-08H15ZF	-08	13/16"-16	12	-08	80.9	3.19	49.4	1.94	9.9	0.39	15	0.59	24	0.11	0.24
24241-10-08H16TZF	-10	1"-14	12	-08	82.4	3.24	50.9	2.00	10.0	0.39	16	0.63	30	0.15	0.34
24241-10-10H16ZF	-10	1"-14	16	-10	86.6	3.41	52.6	2.07	11.9	0.47	16	0.63	30	0.14	0.30
24241-12-12H21ZF	-12	1 3/16"-12	20	-12	106.9	4.21	68.4	2.69	14.9	0.59	21	0.83	36	0.29	0.64
24241-16-16H24TZF	-16	1 7/16"-12	25	-16	123.4	4.86	76.4	3.01	20.9	0.82	24	0.94	41	0.36	0.80

Braided – standard fittings

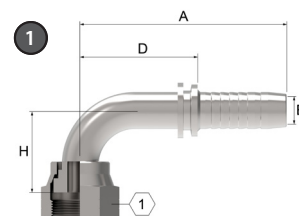

24291

Female ORS Swivel 90° Elbow For use with hose: EC115, EC215 and EC118

PART 1 Part #	HOSE SIZE INFO				DIMENSIONS								WEIGHT		
	Terminal End Dash Size	Thread	Hose Size		A		D Cut Off Factor		E Ø		H		1 mm	Weight	
			DN	Dash Size	mm	in	mm	in	mm	in	mm	in		kg	lb
24291-04-04ZF	-04	9/16"×18	6	-04	58.0	2.28	30.0	1.18	4.0	0.16	41.0	1.61	17	0,052	0.115
24291-06-06ZF	-06	11/16"×16	10	-06	65.3	2.57	35.3	1.39	7.0	0.28	42.5	0.17	22	0,090	0.198
24291-08-08ZF	-08	13/16"×16	12	-08	72.5	2.85	41.0	1.61	10.0	0.39	57.5	2.26	27	0,145	0.320
24291-10-10ZF	-10	1"×14	16	-10	90.0	3.54	56.0	2.20	12.0	0.47	66.0	2.60	30	0,235	0.518
24291-12-12ZF	-12	1.3/16"×12	20	-12	104.0	4.09	65.5	2.58	15.0	0.59	77.0	3.03	36	0,390	0.860
24291-16-16TZF	-16	1.7/16"×12	25	-16	123.9	4.88	76.9	3.03	21.0	0.83	67.5	2.66	41	0,504	1.111
24291-04-04H21ZF	-04	9/16"-18	6	-04	59.5	2.34	31.5	1.24	4.0	0.16	21.0	0.83	17	0.04	0.08
24291-06-04H23TZF	-06	11/16"-16	6	-04	59.5	2.34	31.5	1.24	3.9	0.15	23.0	0.91	22	0.06	0.13
24291-06-04H38TZF	-06	11/16"-16	6	-04	58.0	2.28	30.0	1.18	3.9	0.15	38.0	1.50	22	0.07	0.15
24291-06-04H54TZF	-06	11/16"-16	6	-04	58.0	2.28	30.0	1.18	3.9	0.15	54.0	2.13	22	0.08	0.17
24291-06-06H23ZF	-06	11/16"-16	10	-06	64.5	2.54	34.5	1.36	7.0	0.28	23.0	0.91	22	0.06	0.12
24291-06-06H38ZF	-06	11/16"-16	10	-06	66.0	2.60	36.0	1.42	6.9	0.27	38.0	1.50	22	0.07	0.16
24291-06-06H54ZF	-06	11/16"-16	10	-06	65.3	2.57	35.3	1.39	7.0	0.28	54.0	2.13	22	0.08	0.17
24291-06-08H23ZF	-06	11/16"-16	12	-08	72.9	2.87	41.4	1.63	9.9	0.39	23.0	0.91	22	0.08	0.17
24291-08-06H29TZF	-08	13/16"-16	10	-06	66.0	2.60	36.0	1.42	7.0	0.28	29.0	1.14	24	0.08	0.18
24291-08-08H29ZF	-08	13/16"-16	12	-08	73.0	2.87	41.5	1.63	9.0	0.35	29.0	1.14	24	0.10	0.21
24291-08-08H41ZF	-08	13/16"-16	12	-08	79.0	3.11	47.5	1.87	9.9	0.39	41.0	1.61	24	0.13	0.28
24291-08-08H64ZF	-08	13/16"-16	12	-08	72.5	2.85	41.0	1.61	9.9	0.39	64.0	2.52	24	0.15	0.34
24291-08-10H29ZF	-08	13/16"-16	16	10	86.7	3.41	52.7	2.07	11.9	0.47	29.0	1.14	24	0.13	0.28
24291-10-08H32TZF	-10	1"-14	12	-08	74.0	2.91	42.5	1.67	10.0	0.39	32.0	1.26	30	0.15	0.34
24291-10-08H47TZF	-10	1"-14	12	-08	72.5	2.85	41.0	1.61	9.9	0.39	47.0	1.85	30	0.17	0.37
24291-10-08H70TZF	-10	1"-14	12	-08	72.5	2.85	41.0	1.61	9.9	0.39	70.0	2.76	30	0.19	0.42
24291-10-10H32ZF	-10	1"-14	16	-10	83.5	3.29	49.5	1.95	12.0	0.47	32.0	1.26	30	0.14	0.32
24291-10-10H47ZF	-10	1"-14	16	-10	90.0	3.54	56.0	2.20	11.9	0.47	47.0	1.85	30	0.20	0.45
24291-10-10H70ZF	-10	1"-14	16	-10	90.0	3.54	56.0	2.20	12.0	0.47	70.0	2.76	30	0.24	0.54
24291-10-12H32ZF	-10	1"-14	20	-12	90.8	3.57	52.3	2.06	14.9	0.59	32.0	1.26	30	0.00	0.00
24291-12-10H48TZF	-12	1 3/16"-12	16	-10	90.0	3.54	56.0	2.20	12.0	0.47	48.0	1.89	36	0.26	0.58
24291-12-10H96TZF	-12	1 3/16"-12	16	-10	90.0	3.54	56.0	2.20	11.9	0.47	96.0	3.78	36	0.33	0.73
24291-12-12H48ZF	-12	1 3/16"-12	20	-12	106.0	4.17	67.5	2.66	14.9	0.59	48.0	1.89	36	0.31	0.68
24291-12-12H58ZF	-12	1 3/16"-12	20	-12	106.0	4.17	67.5	2.66	14.9	0.59	58.0	2.28	36	0.32	0.71
24291-12-12H96ZF	-12	1 3/16"-12	20	-12	104.0	4.09	65.5	2.58	14.9	0.59	96.0	3.78	36	0.46	1.01
24291-16-12H56TZF	-16	1 7/16	20	-12	104.0	4.09	65.5	2.58	14.9	0.59	56.0	2.20	41	0.41	0.90
24291-16-16H56TZF	-16	1 7/16"-12	25	-16	119.8	4.72	72.8	2.87	20.9	0.82	56.0	2.20	41	0.44	0.96
24291-16-16H114TZF	-16	1 7/16"-12	25	-16	123.9	4.88	76.9	3.03	20.0	0.79	114	4.49	41	0.64	1.41

Winner

Braided – standard fittings

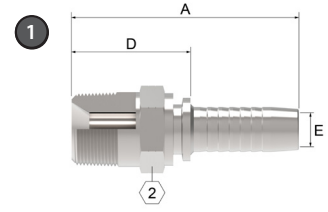

15611

Male Pipe - NPTF For use with hose: EC115, EC215 and EC118

PART		HOSE SIZE INFO				DIMENSIONS						WEIGHT	
1 Part #	Terminal End	Thread	Hose Size		A		D Cut Off Factor		E Ø		2	Weight	
	Dash Size		DN	Dash Size	mm	in	mm	in	mm	in		mm	kg
15611-F02-04ZF	-02	1/8"x27	6	-04	50.5	1.99	22.5	0.89	4.0	0.16	12	0.015	0.033
15611-F04-04ZF	-04	1/4"x18	6	-04	56.0	2.20	28.0	1.10	4.0	0.16	17	0.030	0.066
15611-F04-06ZF	-04	1/4"x18	10	-06	57.5	2.26	27.5	1.08	7.0	0.28	17	0.032	0.070
15611-F06-06ZF	-06	3/8"x18	10	-06	59.0	2.32	29.0	1.14	7.0	0.28	19	0.048	0.106
15611-F08-06ZF	-08	1/2"x14	10	-06	64.0	2.52	34.0	1.34	7.0	0.28	22	0.068	0.150
15611-F08-08ZF	-08	1/2"x14	12	-08	66.0	2.60	34.5	1.36	10.0	0.39	22	0.075	0.165
15611-F12-12ZF	-12	3/4"x14	20	-12	77.0	3.03	38.5	1.52	15.0	0.59	27	0.130	0.286
15611-F16-16ZF	-16	1"x11.5	25	-16	93.5	3.68	46.5	1.83	21.0	0.83	36	0.230	0.506

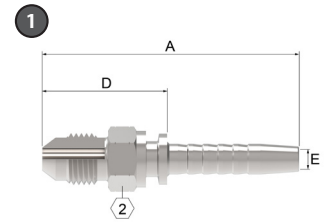

16711

Male JIC/SAE 37° For use with hose: EC115, EC215 and EC118

PART		HOSE SIZE INFO				DIMENSIONS						WEIGHT	
1 Part #	Terminal End	Thread	Hose Size		A		D Cut Off Factor		E Ø		2	Weight	
	Dash Size		DN	Dash Size	mm	in	mm	in	mm	in		mm	kg
16711-06-04ZF	-06	9/16"x18	6	-04	54.5	2.15	26.5	1.04	4.00	0.16	17	0.03	0.07
16711-08-06ZF	-08	3/4"x16	10	-06	61.5	2.42	31.5	1.24	7.00	0.28	22	0.06	0.14
16711-08-08ZF	-08	3/4"x16	12	-08	63.5	2.50	32.0	1.26	9.90	0.39	22	0.06	0.13
16711-10-08ZF	-10	7/8"x14	12	-08	65.5	2.58	34.0	1.34	10.0	0.39	24	0.08	0.19
16711-10-10ZF	-10	7/8"x14	16	-10	69.0	2.72	35.0	1.38	12.0	0.47	24	0.09	0.20
16711-12-10ZF	-12	11/16"x12	16	-10	73.5	2.89	39.5	1.56	12.0	0.47	30	0.12	0.26
16711-16-12ZF	-16	1 5/16"x12	20	-12	81.5	3.21	43.0	1.69	15.0	0.59	36	0.19	0.42

Braided – standard fittings

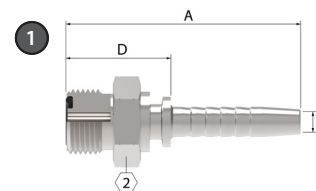

14211

Male ORS For use with hose: EC115, EC215 and EC118

PART 1 Part #	HOSE SIZE INFO				DIMENSIONS							WEIGHT	
	Terminal End	Thread	Hose Size		A		D Cut Off Factor		E Ø		1	Weight	
	Dash Size		DN	Dash Size	mm	in	mm	in	mm	in	mm	kg	lb
14211-06-04ZF	-06	11/16"-16	6	-04	52.0	2.05	24.0	0.94	3.9	0.15	19	0.04	0.08
14211-06-06ZF	-06	11/16"-16	10	-06	54.0	2.13	24.0	0.94	6.7	0.26	19	0.04	0.09
14211-08-06ZF	-08	13/16"-16	10	-06	57.5	2.26	27.5	1.08	7.0	0.28	22	0.06	0.13
14211-08-08ZF	-08	13/16"-16	12	-08	60.0	2.36	28.5	1.12	9.6	0.38	22	0.07	0.15
14211-10-08ZF	-10	1"-14	12	-08	64.0	2.52	32.5	1.28	10.0	0.39	27	0.11	0.24
14211-12-10ZF	-12	1 3/16"-12	16	-10	70.0	2.76	36.0	1.42	12.0	0.47	32	0.16	0.36
14211-12-12ZF	-12	1 3/16"-12	20	-12	75.0	2.95	36.5	1.44	15.0	0.59	32	0.17	0.38
14211-16-12ZF	-16	1 7/16"-12	20	-12	75.5	2.97	37.0	1.46	14.9	0.59	38	0.23	0.50

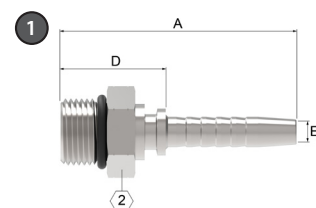

16011

Male Boss O-Ring For use with hose: EC115, EC215 and EC118

PART 1 Part #	HOSE SIZE INFO				DIMENSIONS							WEIGHT	
	Terminal End	Thread	Hose Size		A		D Cut Off Factor		E Ø		1	Weight	
	Dash Size		DN	Dash Size	mm	in	mm	in	mm	in	mm	kg	lb
16011-06-04ZF	-06	9/16"-18	6	-04	50.5	1.99	22.5	0.89	3.9	0.15	17	0.03	0.06
16011-06-06ZF	-06	9/16"-18	10	-06	52.5	2.07	22.5	0.89	6.9	0.27	17	0.03	0.07
16011-08-06ZF	-08	3/4"-16	10	-06	53.5	2.11	23.5	0.93	6.9	0.27	22	0.05	0.10
16011-08-08ZF	-08	3/4"-16	12	-08	55.5	2.19	24.0	0.94	9.9	0.39	22	0.06	0.12

Winner

Aeroquip by Danfoss

Spiral fittings

4S & 6S series







Hose to fitting chart

Match the
to the spiral

Premium core hose:     

Standard core hose: 

4S series fittings (pg 187 - 236)			6S series fittings (pg 187 - 236)			1W series fittings (pg 237 - 240)		
For use with hoses:		See page:	For use with hoses:		See page:	For use with hoses:		See page:
GH493		47	FC500		50	EC600		53
FC736		48	F273B		51	GH506		66
EC525		49	EC810		52	GH466		68
FC500		50	EC600		53	EC850		70
F273B		51	FC606		67	EC910		71
EC810		52	GH466		68			
EC600		53	EC850		70			
GH506		66	EC420		82			
FC254		65						
FC636		69						
EC850		70						
EC415		81						
EC420		82						

Spiral – 4S and 6S series

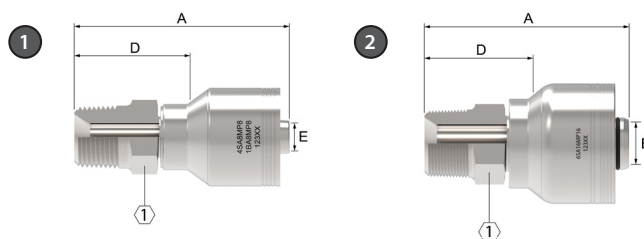

MP

Male Pipe NPTF - Rigid (Straight)

PART	HOSE SIZE INFO				DIMENSIONS						
	Terminal End Hose Size	DN	Hose size	Thread	A		D		EØ		①
① 4S part #					mm	in	mm	in	mm	in	in
4SA8MP12	-8	19	-12	1/	84,6	3.33	48,4	1.90	14,2	0.56	7/8
4SA12MP12	-12	19	-12	3/4	85,9	3.38	49,6	1.95	14,2	0.56	1 1/16
4SA16MP12	-16	19	-12	1-11 1/2	84,8	3.34	48,6	1.91	14,2	0.56	1 3/8
4SA12MP16	-12	25	-16	3/4	89,1	3.51	49,2	1.94	19,2	0.75	1 3/8
4SA16MP16	-16	25	-16	1-11 1/2	94,0	3.70	54,1	2.13	19,2	0.75	1 3/8
4SA20MP16	-20	25	-16	1 1/4-11 1/2	90,4	3.56	50,5	1.99	19,2	0.75	1 11/16
4SA16MP20	-16	31	-20	1-11 1/2	107,6	4.24	52,5	2.07	25,2	0.99	1 7/16
4SA20MP20	-20	31	-20	1 1/4-11 1/2	119,6	4.71	64,4	2.54	25,2	0.99	1 11/16
4SA24MP24	-24	38	-24	1 1/2-11 1/2	143,2	5.64	65,2	2.57	31,1	1.22	2
4SA32MP32	-32	51	-32	2-11 1/2	150,1	5.91	72,1	2.84	42,1	1.66	2 1/2
② 6S part #	Terminal End Hose Size	DN	Hose size	Thread	A		D		EØ		
6SA16MP16	-16	25	-16	1-11 1/2	94,0	3.70	54,1	2.13	19,2	0.75	1 3/8
6SA20MP20	-20	31	-20	1 1/4-11 1/2	120,4	4.74	64,4	2.54	25,2	0.99	1 11/16
6SA24MP24	-24	38	-24	1 1/2-11 1/2	143,2	5.64	65,2	2.57	31,1	1.22	2
6SA32MP32	-32	51	-32	2-11 1/2	150,1	5.91	72,1	2.84	42,1	1.66	2 1/2

Spiral – 4S and 6S series

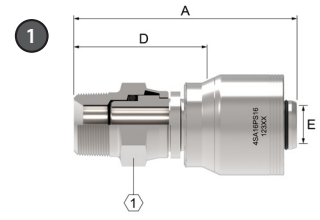

PS

Male Pipe NPTF - Swivel (Straight)

PART	HOSE SIZE INFO				DIMENSIONS							
	4S part #	Terminal End Hose Size	DN	Hose size	Thread	A		D		EØ		1
						mm	in	mm	in	mm	in	in
4SA16PS16	-16	25	-16	1 11 1/2		110,2	4.34	70,1	2.76	19,2	0.75	1 1/2

Spiral – 4S and 6S series

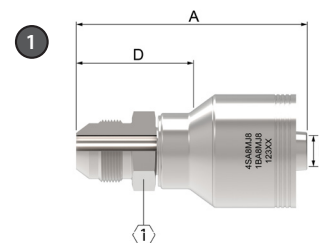

MJ

Male JIC/37° - Rigid (Straight)

PART	HOSE SIZE INFO				DIMENSIONS						
	Terminal End Hose Size	DN	Hose size	Thread	A		D		EØ		1
1 4S part #					mm	in	mm	in	mm	in	in
4SA10MJ12	-10	19	-12	7/8	84,3	3.32	48,2	1.90	12,3	0.48	15/16
4SA12MJ12	-12	19	-12	1 1/16	86,9	3.42	50,8	2.00	14,2	0.56	1 1/8
4SA14MJ12	-14	19	-12	1 3/16	83,1	3.27	47,0	1.85	14,2	0.56	1 1/4
4SA16MJ12	-16	19	-12	1 5/16	83,6	3.29	47,5	1.87	14,2	0.56	1 3/8
4SA16MJ16	-16	25	-16	1 5/16	93,7	3.69	54,0	2.13	19,2	0.75	1 3/8
4SA20MJ16	-20	25	-16	1 5/8	99,6	3.92	60,0	2.36	19,2	0.76	1 11/16
4SA20MJ20	-20	31	-20	1 5/8	115,7	4.56	60,5	2.38	25,2	0.99	1 11/16
4SA24MJ24	-24	38	-24	1 7/8	151,3	5.96	73,3	2.89	31,1	1.22	2
4SA32MJ32	-32	51	-32	2 1/2	163,8	6.45	85,8	3.38	42,1	1.66	2 5/8

See note below

When assembled with all Danfoss components, all SAE 37° JIC male and female terminal ends in the 4S & 6S product line are rated at the pressures listed in the table above and have passed one million impulse cycles at 133% of this pressure. All straight configurations achieve a 4:1 burst.

The 45° and 90° elbow configurations in the -12 size meet a 3.2:1 burst the 45° and 90° elbow configurations in the -16 size achieve a 2.8:1 burst; the 45° and 90° elbow configurations in the -20 size meet a 4:1 burst and the 45° & 90° elbow configurations in the -24 size meet a 2.4:1 burst.

Spiral – 4S and 6S series

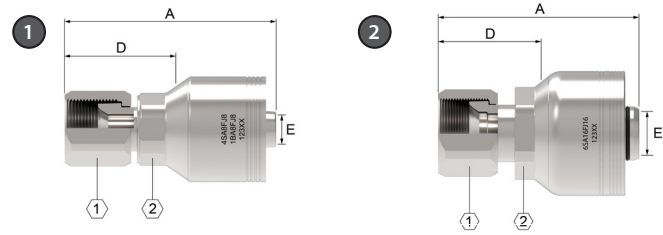

FJ

Female JIC/37° swivel (Straight)

PART	HOSE SIZE INFO				DIMENSIONS								
	Terminal End Hose Size	DN	Hose size	Thread	A		D		EØ		1	2	
4S part #					mm	in	mm	in	mm	in	in	mm	in
4SA10FJ12	-10	19	-12	7/8	75,0	2.95	38,8	1.53	12,3	0.48	1	30,0	1 3/16
4SA12FJ12	-12	19	-12	1 1/16	82,0	3.23	45,7	1.80	14,2	0.56	1 1/4	30,0	1 3/16
4SA14FJ12	-14	19	-12	1 3/16	77,5	3.05	41,3	1.63	14,2	0.56	1 3/8	30,0	1 3/16
4SA16FJ12	-16	19	-12	1 5/16	80,2	3.16	44,0	1.73	14,2	0.56	1 1/2	30,0	1 3/16
4SA12FJ16	-12	25	-16	1 1/16	78,8	3.10	39,1	1.54	15,5	0.61	1 1/4	41,0	1 5/8
4SA16FJ16	-16	25	-16	1 5/16	89,2	3.51	49,3	1.94	19,2	0.76	1 1/2	41,0	1 5/8
4SA20FJ16	-20	25	-16	1 5/8	85,8	3.38	46,0	1.81	19,2	0.76	2	41,0	1 5/8
4SA16FJ20	-16	31	-20	1 5/16	99,1	3.90	43,7	1.72	25,2	0.99	1 1/2	46,0	1 13/16
4SA20FJ20	-20	31	-20	1 5/8	101,6	4.00	46,3	1.82	25,2	0.99	2	46,0	1 13/16
4SA24FJ20	-24	31	-20	1 7/8	106,8	4.20	51,5	2.03	25,2	0.99	2 1/4	46,0	1 13/16
4SA24FJ24	-24	38	-24	1 7/8	134,9	5.31	56,8	2.24	31,1	1.22	2 1/4	57,0	2 1/4
4SA32FJ32	-32	51	-32	2 1/2	146,0	5.75	68,0	2.68	42,1	1.66	2 7/8		
6S part #	Terminal End Hose Size	DN	Hose size	Thread	A		D		EØ		1	2	
6SA16FJ16	-16	25	-16	1 5/16	89,2	3.51	49,3	1.94	19,2	0.76	1 1/2	41,0	1 5/8
6SA20FJ20	-20	31	-20	1 5/8	102,3	4.03	46,3	1.82	25,2	0.99	2	46,0	1 13/16
6SA24FJ20	-24	31	-20	1 7/8	107,5	4.23	51,5	2.03	25,2	0.99	2 1/4	46,0	1 13/16
6SA24FJ24	-24	38	-24	1 7/8	134,9	5.31	56,8	2.24	31,1	1.22	2 1/4	57,0	2 1/4
6SA32FJ32	-32	51	-32	2 1/2	146,0	5.75	68,0	2.68	42,1	1.66	2 7/8		

See note below

When assembled with all Danfoss components, all SAE 37° JIC male and female terminal ends in the 4S & 6S product line are rated at the pressures listed in the table above and have passed one million impulse cycles at 133% of this pressure. All straight configurations achieve a 4:1 burst.

The 45° and 90° elbow configurations in the -12 size meet a 3.2:1 burst the 45° and 90° elbow configurations in the -16 size achieve a 2.8:1 burst; the 45° and 90° elbow configurations in the -20 size meet a 4:1 burst and the 45° & 90° elbow configurations in the -24 size meet a 2.4:1 burst.

Spiral – 4S and 6S series

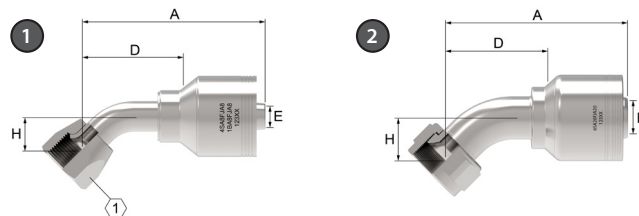

FJA

Female JIC/37° swivel (45° elbow)

PART	HOSE SIZE INFO				DIMENSIONS								
	Terminal End Hose Size	DN	Hose size	Thread	A		D		EØ		H		①
① 4S part #					mm	in	mm	in	mm	in	mm	in	in
4SA12FJA12	-12	19	-12	1 1/16	112,3	4.42	76,1	3.00	14,2	0.56	29,0	1.14	1 1/4
4SA16FJA12	-16	19	-12	1 5/16	133,6	5.26	97,5	3.84	14,2	0.56	38,0	1.50	1 1/2
4SA16FJA16	-16	25	-16	1 5/16	128,8	5.07	89,3	3.52	19,2	0.76	38,0	1.50	1 1/2
4SA20FJA16	-20	25	-16	1 5/8	120,1	4.73	80,4	3.17	19,2	0.75	32,0	1.26	2
4SA20FJA20	-20	31	-20	1 5/8	135,6	5.34	80,4	3.17	25,2	0.99	32,0	1.26	2
4SA24FJA24	-24	38	-24	1 7/8	212,0	8.35	134,0	5.28	31,1	1.22	43,0	1.69	2 1/4
② 6S part #	Terminal End Hose Size	DN	Hose size	Thread	A		D		EØ				
6SA20FJA20	-20	31	-20	1 5/8	136,4	5.37	80,4	3.17	25,2	0.99	32,0	1.26	2
6SA24FJA24	-24	38	-24	1 7/8	212,0	8.35	134,0	5.28	31,1	1.22	43,0	1.69	2 1/4

See note below

When assembled with all Danfoss components, all SAE 37° JIC male and female terminal ends in the 4S & 6S product line are rated at the pressures listed in the table above and have passed one million impulse cycles at 133% of this pressure. All straight configurations achieve a 4:1 burst.

The 45° and 90° elbow configurations in the -12 size meet a 3.2:1 burst the 45° and 90° elbow configurations in the -16 size achieve a 2.8:1 burst; the 45° and 90° elbow configurations in the -20 size meet a 4:1 burst and the 45° & 90° elbow configurations in the -24 size meet a 2.4:1 burst.

Spiral – 4S and 6S series

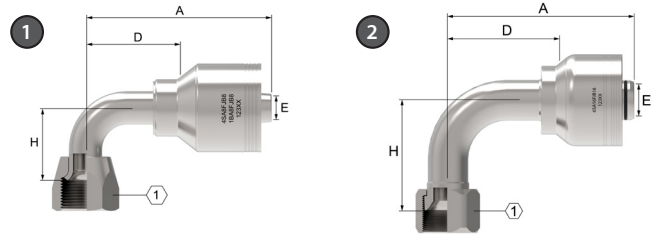

FJB

Female JIC/37° swivel (90° elbow)

PART	HOSE SIZE INFO				DIMENSIONS								
	Terminal End Hose Size	DN	Hose size	Thread	A		D		EØ		H		1
4S part #					mm	in	mm	in	mm	in	mm	in	in
4SA12FJB12	-12	19	-12	1 1/16	101,3	3.99	65,3	2.57	14,2	0.56	58,0	2.28	1 1/4
4SA16FJB12	-16	19	-12	1 5/16	110,0	4.33	73,8	2.91	14,2	0.56	71,0	2.80	1 1/2
4SA16FJB16	-16	25	-16	1 5/16	113,1	4.45	73,5	2.89	19,2	0.76	71,0	2.80	1 1/2
4SA20FJB16	-20	25	-16	1 5/8	117,1	4.61	77,4	3.05	19,2	0.75	78,0	3.07	2
4SA20FJB20	-20	31	-20	1 5/8	132,6	5.22	77,4	3.05	25,2	0.99	78,0	3.07	2
4SA24FJB24	-24	38	-24	1 7/8	208,9	8.22	130,8	5.15	31,1	1.22	104,0	4.09	2 1/4
6S part #	Terminal End Hose Size	DN	Hose size	Thread	A		D		EØ		H		1
6SA16FJB16	-16	25	-16	1 5/16	113,1	4.45	73,5	2.89	19,0	0.75	71,0	2.80	1 1/2
6SA20FJB20	-20	31	-20	1 5/8	133,4	5.25	77,4	3.05	25,2	0.99	78,0	3.07	2
6SA24FJB24	-24	38	-24	1 7/8	208,9	8.22	130,8	5.15	31,1	1.22	104,0	4.09	2 1/4

See note below

When assembled with all Danfoss components, all SAE 37° JIC male and female terminal ends in the 4S & 6S product line are rated at the pressures listed in the table above and have passed one million impulse cycles at 133% of this pressure. All straight configurations achieve a 4:1 burst.

The 45° and 90° elbow configurations in the -12 size meet a 3.2:1 burst; the 45° and 90° elbow configurations in the -16 size achieve a 2.8:1 burst; the 45° and 90° elbow configurations in the -20 size meet a 4:1 burst and the 45° & 90° elbow configurations in the -24 size meet a 2.4:1 burst.

Spiral – 4S and 6S series

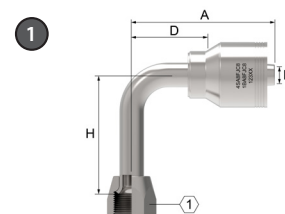

FJC

Female JIC/37° swivel (90° Elbow - Long Drop)

PART ① 4S part #	HOSE SIZE INFO				DIMENSIONS								
	Terminal End Hose Size	DN	Hose size	Thread	A		D		EØ		H		①
					mm	in	mm	in	mm	in	mm	in	in
4SA12FJC12	-12	19	-12	1 1/16	101,3	3.99	65,3	2.57	14,2	0.56	96,0	3.78	1 1/4
4SA16FJC16	-16	25	-16	1 5/16	112,5	4.43	73,5	2.89	19,0	0.75	114,0	4.49	1 1/2
4SA20FJC20	-20	31	-20	1 5/8	132,6	5.22	77,4	3.05	25,2	0.99	129,0	5.08	2

See note below

When assembled with all Danfoss components, all SAE 37° JIC male and female terminal ends in the 4S & 6S product line are rated at the pressures listed in the table above and have passed one million impulse cycles at 133% of this pressure. All straight configurations achieve a 4:1 burst.

The 45° and 90° elbow configurations in the -12 size meet a 3.2:1 burst the 45° and 90° elbow configurations in the -16 size achieve a 2.8:1 burst; the 45° and 90° elbow configurations in the -20 size meet a 4:1 burst and the 45° & 90° elbow configurations in the -24 size meet a 2.4:1 burst.

Spiral – 4S and 6S series

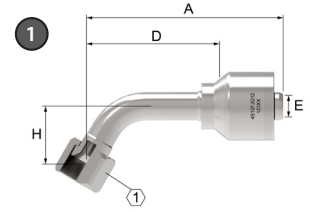

FJG

Female JIC/37° - swivel (60° elbow)

PART	HOSE SIZE INFO				DIMENSIONS									
	4S part #	Terminal End Hose Size	DN	Hose size	Thread	A		D		EØ		H		①
						mm	in	mm	in	mm	in	mm	in	in
4SA12FJG12		-12	19	-12	1 1/16	127,0	5.00	90,8	3.58	14,2	0.56	38,9	1.53	1 1/4
4SA16FJG16		-16	25	-16	1 5/16	144,4	5.69	104,8	4.12	19,2	0.76	47,6	1.87	1 1/2

See note below

When assembled with all Danfoss components, all SAE 37° JIC male and female terminal ends in the 4S & 6S product line are rated at the pressures listed in the table above and have passed one million impulse cycles at 133% of this pressure. All straight configurations achieve a 4:1 burst.

The 45° and 90° elbow configurations in the -12 size meet a 3.2:1 burst; the 45° and 90° elbow configurations in the -16 size achieve a 2.8:1 burst; the 45° and 90° elbow configurations in the -20 size meet a 4:1 burst and the 45° & 90° elbow configurations in the -24 size meet a 2.4:1 burst.

Spiral – 4S and 6S series

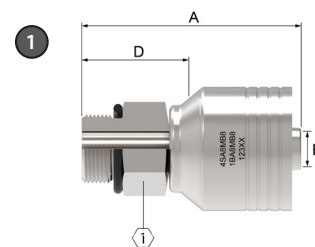

MB

Male O-ring boss - Rigid (Straight)

PART	HOSE SIZE INFO				DIMENSIONS						
	Terminal End Hose Size	DN	Hose size	Thread	A		D		EØ		1
1 4S part #					mm	in	mm	in	mm	in	mm
4SA12MB12	-12	19	-12	1 1/16	78,7	3.10	42,5	1.67	14,2	0.56	1 1/4
4SA16MB16	-16	25	-16	1 5/16	88,1	3.47	48,5	1.91	19,2	0.76	1 1/2
4SA20MB20	-20	31	-20	1 5/8	109,5	4.31	54,4	2.14	25,2	0.99	1 7/8
4SA24MB24	-24	38	-24	1 7/8	134,1	5.28	56,0	2.21	31,1	1.22	2 1/8

Spiral – 4S and 6S series

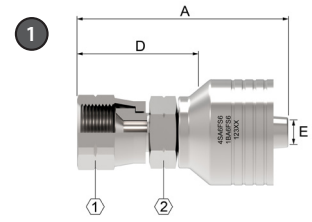

FS

Female SAE 45° flare swivel (straight)

PART	HOSE SIZE INFO				DIMENSIONS							
	Terminal End Hose Size	DN	Hose size	Thread	A		D		EØ		1	2
① 4S part #					mm	in	mm	in	mm	in	in	in
4SA12FS12	-12	19	-12	1 1/16	61,5	2.42	25,4	1.00	14,2	0.56	1 1/4	1 3/16

Spiral – 4S and 6S series

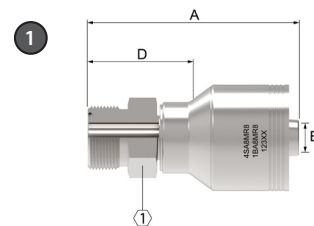

MR

Male ORS - rigid (straight)

PART	HOSE SIZE INFO				DIMENSIONS						
	Terminal End Hose Size	DN	Hose size	Thread	A		D		EØ		1
1 4S part #					mm	in	mm	in	mm	in	in
4SA12MR12	-12	19	-12	1 3/16	80,8	3.18	44,4	1.75	14,2	0.56	1 1/4
4SA16MR12	-16	19	-12	1 7/16	78,2	3.08	41,9	1.65	14,2	0.56	1 1/2
4SA16MR16	-16	25	-16	1 7/16	87,7	3.45	47,9	1.89	19,2	0.76	1 1/2
4SA20MR16	-20	25	-16	1 11/16	81,1	3.19	41,5	1.63	19,2	0.76	1 3/4
4SA20MR20	-20	31	-20	1 11/16	107,1	4.22	52,0	2.05	25,2	0.99	1 3/4

Spiral – 4S and 6S series

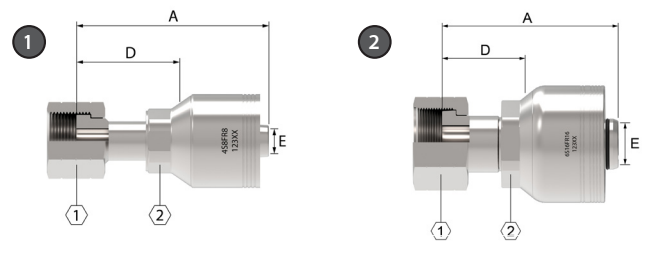

FR

Female ORS swivel (straight)

PART		HOSE SIZE INFO				DIMENSIONS								
1 4S part #	Terminal End Hose Size	DN	Hose size	Thread	A		D		EØ		1		2	
					mm	in	mm	in	mm	in	in	mm	in	
4SA10FR12	-10	19	-12	1	74,4	2.93	38,1	1.50	14,2	0.56	1 1/8	30,0	1 3/16	
4SA12FR12	-12	19	-12	1 3/16	77,4	3.05	41,2	1.62	14,2	0.56	1 3/8	30,0	1 3/16	
4SA16FR12	-16	19	-12	1 7/16	79,2	3.12	43,1	1.70	14,2	0.56	1 5/8	30,0	1 3/16	
4SA12FR16	-12	25	-16	1 3/16	80,5	3.17	40,8	1.61	19,2	0.76	1 3/8	41,0	1 5/8	
4SA16FR16	-16	25	-16	1 7/16	82,4	3.24	42,6	1.68	19,2	0.76	1 5/8	41,0	1 5/8	
4SA20FR16	-20	25	-16	1 11/16	82,4	3.24	42,7	1.68	19,2	0.76	1 7/8	41,0	1 5/8	
4SA20FR20	-20	31	-20	1 11/16	99,0	3.90	43,8	1.72	25,2	0.99	1 7/8	46,0	1 13/16	
4SA24FR24	-24	38	-24	2	125,7	4.95	47,6	1.87	31,1	1.22	2 1/4	57,0	2 1/4	
2 6S part #	Terminal End Hose Size	DN	Hose size	Thread	A		D		EØ		1		2	
					mm	in	mm	in	mm	in	in	mm	in	
6SA16FR16	-16	25	-16	1 7/16	82,4	3.24	42,6	1.68	19,2	0.76	1 5/8	41,0	1 5/8	
6SA20FR16	-20	25	-16	1 11/16	82,4	3.24	42,7	1.68	19,2	0.76	1 7/8	41,0	1 5/8	
6SA20FR20	-20	31	-20	1 11/16	99,8	3.93	43,8	1.72	25,2	0.99	1 7/8	46,0	1 13/16	
6SA24FR24	-24	38	-24	2	125,7	4.95	47,6	1.87	31,1	1.22	2 1/4	57,0	2 1/4	

Spiral – 4S and 6S series

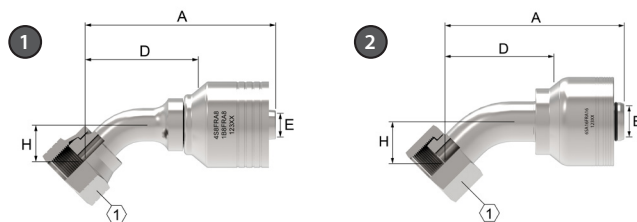

FRA

Female ORS swivel (45° elbow)

PART	HOSE SIZE INFO				DIMENSIONS								
	Terminal End Hose Size	DN	Hose size	Thread	A		D		EØ		H		1
4S part #					mm	in	mm	in	mm	in	mm	in	in
4SA12FRA12	-12	19	-12	1 3/16	108,7	4.28	72,5	2.85	14,2	0.56	24,0	0.94	1 3/8
4SA16FRA12	-16	19	-12	1 7/16	119,9	4.72	83,7	3.30	14,2	0.56	28,0	1.10	1 5/8
4SA16FRA16	-16	25	-16	1 7/16	112,8	4.44	73,0	2.87	19,2	0.76	28,0	1.10	1 5/8
4SA20FRA16	-20	25	-16	1 11/16	136,7	5.38	97,0	3.82	19,2	0.76	31,0	1.22	1 7/8
4SA20FRA20	-20	31	-20	1 11/16	153,4	6.04	98,1	3.86	25,2	0.99	31,0	1.22	1 7/8
4SA24FRA24	-24	38	-24	2	212,0	8.35	134,0	5.28	31,1	1.22	43,0	1.69	2 1/4
6S part #	Terminal End Hose Size	DN	Hose size	Thread	A		D		EØ		H		1
6SA16FRA16	-16	25	-16	1 7/16	112,8	4.44	73,0	2.87	19,2	0.76	28,0	1.10	1 5/8
6SA20FRA16	-20	25	-16	1 11/16	136,7	5.38	97,0	3.82	19,2	0.76	31,0	1.22	1 7/8
6SA20FRA20	-20	31	-20	1 11/16	154,1	6.07	98,1	3.86	25,2	0.99	31,0	1.22	1 7/8
6SA24FRA24	-24	38	-24	2	212,0	8.35	134,0	5.28	31,1	1.22	43,0	1.69	2 1/4

Spiral – 4S and 6S series

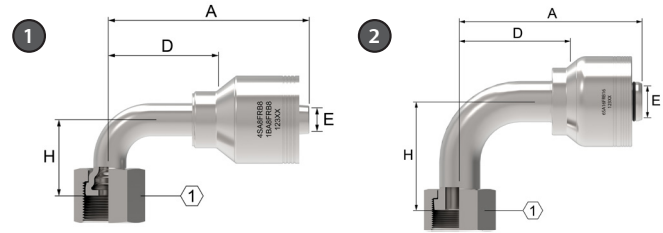

FRB

Female ORS swivel (90° elbow)

PART		HOSE SIZE INFO				DIMENSIONS							
1 4S part #	Terminal End Hose Size	DN	Hose size	Thread	A		D		EØ		H		1
					mm	in	mm	in	mm	in	mm	in	
4SA10FRB12	-10	19	-12	1	91,5	3.60	55,3	2.18	14,2	0.56	32,3	1.27	1 1/8
4SA12FRB12	-12	19	-12	1 3/16	104,4	4.11	68,1	2.68	14,2	0.56	58,0	2.28	1 3/8
4SA16FRB12	-16	19	-12	1 7/16	117,1	4.61	80,9	3.19	14,2	0.56	71,0	2.80	1 5/8
4SA12FRB16	-12	25	-16	1 3/16	107,5	4.23	67,7	2.67	19,2	0.76	58,0	2.28	1 3/8
4SA16FRB16	-16	25	-16	1 7/16	112,8	4.44	73,0	2.87	19,2	0.76	71,0	2.80	1 5/8
4SA20FRB16	-20	25	-16	1 11/16	136,5	5.37	96,8	3.81	19,2	0.76	78,0	3.07	1 7/8
4SA20FRB20	-20	31	-20	1 11/16	153,1	6.03	97,9	3.85	25,2	0.99	78,0	3.07	1 7/8
4SA24FRB20	-24	31	-20	2	152,9	6.02	97,9	3.85	25,2	0.99	86,0	3.39	2 1/4
4SA24FRB24	-24	38	-24	2	208,9	8.22	130,8	5.15	31,1	1.22	104,0	4.09	2 1/4
2 6S part #	Terminal End Hose Size	DN	Hose size	Thread	A		D		EØ		H		1
					mm	in	mm	in	mm	in	mm	in	
6SA16FRB16	-16	25	-16	1 7/16	112,8	4.44	73,0	2.87	19,2	0.76	71,0	2.80	1 5/8
6SA20FRB16	-20	25	-16	1 11/16	136,5	5.37	96,8	3.81	19,2	0.76	78,0	3.07	1 7/8
6SA20FRB20	-20	31	-20	1 11/16	153,9	6.06	97,9	3.85	25,2	0.99	78,0	3.07	1 7/8
6SA24FRB24	-24	38	-24	2	208,9	8.22	130,8	5.15	31,1	1.22	104,0	4.09	2 1/4

Spiral – 4S and 6S series

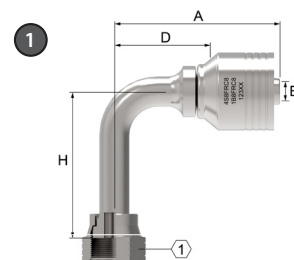

FRC

Female ORS swivel (90° elbow - long drop)

PART 4S part #	HOSE SIZE INFO				DIMENSIONS								
	Terminal End Hose Size	DN	Hose size	Thread	A		D		EØ		H		1
					mm	in	mm	in	mm	in	mm	in	in
4SA10FRC12	-10	19	-12	1	91,5	3.60	55,3	2.18	14,2	0.56	70,0	2.76	1 1/8
4SA12FRC12	-12	19	-12	1 3/16	104,4	4.11	68,0	2.68	14,2	0.56	96,0	3.78	1 3/8
4SA16FRC12	-16	19	-12	1 7/16	117,1	4.61	80,9	3.19	14,2	0.56	114,0	4.49	1 5/8
4SA16FRC16	-16	25	-16	1 7/16	112,8	4.44	73,0	2.87	19,2	0.76	114,0	4.49	1 5/8
4SA20FRC20	-20	31	-20	1 11/16	152,9	6.02	97,9	3.85	25,2	0.99	129,0	5.08	1 7/8
4SA24FRC20	-24	31	-20	2	152,9	6.02	97,9	3.85	25,2	0.99	141,0	5.55	2 1/4
4SA24FRC24	-24	38	-24	2	152,9	6.02	97,9	3.85	25,2	0.99	141,0	5.55	2 1/4

Spiral – 4S and 6S series

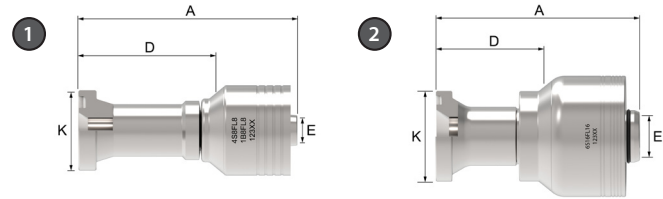

FL

SAE Code 61 Flange (straight)

PART	HOSE SIZE INFO			DIMENSIONS							
	Terminal End Hose Size	DN	Hose size	Flange Head Dia. K Ø		A		D		EØ	
1 4S part #				mm	in	mm	in	mm	in	mm	in
4S12FL12	-12	19	-12	38,1	1.50	90,7	3.57	54,5	2.15	14,2	0.56
4S16FL12	-16	19	-12	44,5	1.75	90,2	3.55	54,0	2.13	14,2	0.56
4S20FL12	-20	19	-12	50,8	2.00	97,7	3.85	61,5	2.42	14,2	0.56
4S16FL16	-16	25	-16	44,5	1.75	93,3	3.67	53,6	2.11	19,2	0.76
4S20FL16	-20	25	-16	50,8	2.00	100,8	3.97	61,1	2.41	19,2	0.76
4S24FL16	-24	25	-16	60,4	2.38	97,4	3.83	57,7	2.27	19,2	0.76
4S16FL20	-16	31	-20	44,5	1.75	110,5	4.35	55,5	2.18	25,2	0.99
4S20FL20	-20	31	-20	50,8	2.00	117,4	4.62	62,2	2.45	25,2	0.99
4S24FL20	-24	31	-20	60,4	2.38	106,7	4.20	51,6	2.03	25,2	0.99
4S32FL20	-32	31	-20	71,4	2.81	104,9	4.13	49,9	1.96	25,2	0.99
4S24FL24	-24	38	-24	60,4	2.38	171,6	6.75	93,6	3.68	31,1	1.22
4S32FL24	-32	38	-24	71,4	2.81	174,7	6.88	96,7	3.81	31,1	1.22
4S32FL32	-32	51	-32	71,4	2.81	177,5	6.99	99,5	3.92	42,1	1.66
2 6S part #	Terminal End Hose Size	DN	Hose size	Flange Head Dia. K Ø		A		D		EØ	
6S16FL16	-16	25	-16	44,5	1.75	93,3	3.67	53,6	2.11	19,2	0.76
6S20FL20	-20	31	-20	50,8	2.00	118,2	4.65	62,2	2.45	25,2	0.99
6S24FL24	-24	38	-24	60,4	2.38	171,6	6.75	93,6	3.68	31,1	1.22
6S32FL24	-32	38	-24	71,4	2.81	174,7	6.88	96,7	3.81	31,1	1.22
6S32FL32	-32	51	-32	71,4	2.81	177,5	6.99	99,5	3.92	42,1	1.66

Spiral – 4S and 6S series

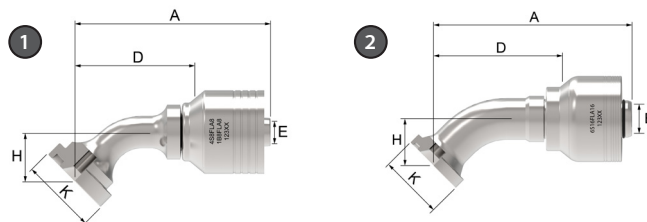

FLA

SAE Code 61 Flange (45° elbow)

PART	HOSE SIZE INFO			DIMENSIONS									
	Terminal End Hose Size	DN	Hose size	Flange Head Dia. K Ø		A		D		EØ		H	
1 4S part #				mm	in	mm	in	mm	in	mm	in	mm	in
4S12FLA12	-12	19	-12	38,1	1.50	113,8	4.48	77,6	3.06	14,2	0.56	27,0	1.06
4S16FLA12	-16	19	-12	44,4	1.75	127,9	5.04	91,7	3.61	14,2	0.56	32,0	1.26
4S12FLA16	-12	25	-16	38,1	1.50	116,9	4.60	77,2	3.04	19,2	0.76	27,0	1.06
4S16FLA16	-16	25	-16	44,4	1.75	131,0	5.16	91,3	3.59	19,2	0.76	32,0	1.26
4S20FLA16	-16	31	-20	44,4	1.75	152,1	5.99	97,0	3.82	25,2	0.99	32,0	1.26
4S16FLA20	-20	25	-16	50,8	2.00	150,2	5.91	110,5	4.35	19,2	0.76	39,0	1.54
4S20FLA20	-20	31	-20	50,8	2.00	166,8	6.57	111,6	4.39	25,2	0.99	39,0	1.54
4S24FLA20	-24	31	-20	60,4	2.38	161,6	6.36	106,6	4.20	25,2	0.99	39,5	1.34
4S24FLA24	-24	38	-24	60,3	2.37	214,3	8.44	136,3	5.37	31,1	1.22	45,0	1.77
4S32FLA24	-32	38	-24	71,4	2.81	251,0	9.88	173,0	6.81	31,1	1.22	57,5	2.26
4S32FLA32	-32	51	-32	71,4	2.81	253,9	10.00	175,9	6.92	42,1	1.66	57,5	2.26
2 6S part #	Terminal End Hose Size	DN	Hose size	Flange Head Dia. K Ø		A		D		EØ		H	
6S16FLA16	-16	25	-16	44,4	1.75	131,0	5.16	91,3	3.59	19,2	0.76	32,0	1.26
6S20FLA16	-20	25	-16	50,8	2.00	150,2	5.91	110,5	4.35	19,2	0.76	39,0	1.54
6S20FLA20	-20	31	-20	50,8	2.00	167,6	6.60	111,6	4.39	25,2	0.99	39,0	1.54
6S24FLA24	-24	38	-24	60,3	2.37	214,3	8.44	136,3	5.37	31,1	1.22	45,0	1.77
6S32FLA24	-32	38	-24	71,4	2.81	251,0	9.88	173,0	6.81	31,1	1.22	57,5	2.26
6S32FLA32	-32	51	-32	71,4	2.81	253,9	10.00	175,9	6.92	42,1	1.66	57,5	2.26

Spiral – 4S and 6S series

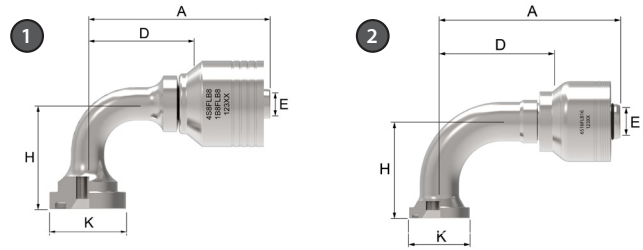

FLB

SAE Code 61 Flange (90° elbow)

PART		HOSE SIZE INFO			DIMENSIONS								
1 4S part #	Terminal End Hose Size	DN	Hose size	Flange Head Dia. K Ø		A		D		EØ		H	
				mm	in	mm	in	mm	in	mm	in	mm	in
4S12FLB12	-12	19	-12	38,1	1.50	108,5	4.27	72,3	2.85	14,2	0.56	59,0	2.32
4S16FLB12	-16	19	-12	44,4	1.75	122,8	4.84	86,6	3.41	14,2	0.56	71,0	2.80
4S20FLB12	-20	19	-12	50,8	2.00	108,5	4.72	72,3	2.85	14,2	0.56	65,0	2.56
4S16FLB16	-16	25	-16	44,4	1.75	126,0	4.96	86,2	3.39	19,2	0.76	71,0	2.80
4S16FLB16.116	-16	25	-16	44,4	1.75	126,0	4.96	86,2	3.39	19,2	0.76	116,0	4.57
4S20FLB16	-20	25	-16	50,8	2.00	145,2	5.72	105,4	4.15	19,2	0.76	89,0	3.50
4S24FLB16	-24	25	-16	60,4	2.38	136,5	5.37	96,8	3.81	19,2	0.76	81,9	3.22
4S16FLB20	-16	31	-20	44,4	1.75	147,1	5.79	91,9	3.62	25,2	0.99	71,0	2.80
4S20FLB20	-20	31	-20	50,8	2.00	161,8	6.37	106,5	4.19	25,2	0.99	89,0	3.50
4S24FLB20	-24	31	-20	60,4	2.38	152,9	6.02	97,9	3.85	25,2	0.99	81,9	3.22
4S24FLB24	-24	38	-24	60,3	2.37	208,9	8.22	130,9	5.15	31,1	1.22	104,0	4.09
4S32FLB24	-32	38	-24	71,4	2.81	247,4	9.74	169,4	6.67	31,1	1.22	138,0	5.43
4S32FLB32	-32	51	-32	71,4	2.81	250,3	9.85	172,2	6.78	42,1	1.66	138,0	5.43
2 6S part #	Terminal End Hose Size	DN	Hose size	Flange Head Dia. K Ø		A		D		EØ		H	
mm				in	mm	in	mm	in	mm	in	mm	in	
6S16FLB16	-16	25	-16	44,4	1.75	126,0	4.96	86,2	3.39	19,2	0.76	71,0	2.80
6S20FLB16	-20	25	-16	50,8	2.00	145,2	5.72	105,4	4.15	19,2	0.76	89,0	3.50
6S20FLB20	-20	31	-20	50,8	2.00	162,5	6.40	106,5	4.19	25,2	0.99	89,0	3.50
6S24FLB24	-24	38	-24	60,3	2.37	208,8	8.22	130,8	5.15	31,1	1.22	104,0	4.09
6S32FLB24	-32	38	-24	71,4	2.81	247,4	9.74	169,4	6.67	31,1	1.22	138,0	5.43
6S32FLB32	-32	51	-32	71,4	2.81	250,3	9.85	172,2	6.78	42,1	1.66	138,0	5.43

Spiral – 4S and 6S series

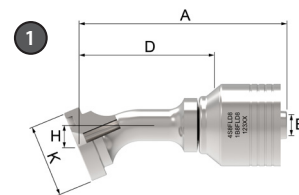

FLD

SAE Code 61 Flange (22.5° elbow)

PART	HOSE SIZE INFO			DIMENSIONS									
	Terminal End Hose Size	DN	Hose size	Flange Head Dia. K Ø		A		D		EØ		H	
1 4S part #				mm	in	mm	in	mm	in	mm	in	mm	in
4S12FLD12	-12	19	-12	38,1	1.50	121,3	4.78	85,1	3.35	14,2	0.56	11,6	0.46
4S16FLD12	-16	25	-12	44,4	1.75	136,7	5.38	100,5	3.96	14,2	0.56	13,5	0.53
4S16FLD16	-16	25	-16	44,4	1.75	139,8	5.50	100,1	3.94	19,2	0.76	13,5	0.53
4S20FLD16	-20	25	-16	50,8	2.00	160,9	6.33	121,2	4.77	19,2	0.76	16,3	0.64
4S20FLD20	-20	31	-20	50,8	2.00	177,3	6.98	122,3	4.81	25,2	0.99	16,3	0.64
4S24FLD20	-24	31	-20	60,4	2.38	173,6	6.83	117,6	4.63	25,2	0.99	17,1	0.67
4S24FLD24	-24	38	-24	60,3	2.37	226,4	8.91	148,4	5.84	31,1	1.22	18,8	0.74
4S32FLD24	-32	38	-24	71,4	2.81	266,7	10.50	188,7	7.43	31,1	1.22	23,5	0.93
4S32FLD32	-32	51	-32	71,4	2.81	269,6	10.61	191,5	7.54	42,1	1.66	23,5	0.93

Spiral – 4S and 6S series

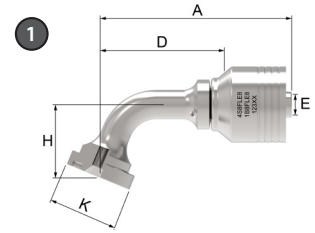

FLE

SAE Code 61 Flange (67.5° elbow)

PART	HOSE SIZE INFO			DIMENSIONS									
	Terminal End Hose Size	DN	Hose size	Flange Head Dia. K Ø		A		D		EØ		H	
1 4S part #				mm	in	mm	in	mm	in	mm	in	mm	in
4S12FLE12	-12	19	-12	38,1	1.50	128,6	5.06	92,4	3.64	14,2	0.56	43,2	1.70
4S16FLE12	-16	19	-12	44,4	1.75	147,0	5.79	110,8	4.36	14,2	0.56	51,5	2.03
4S16FLE16	-16	25	-16	44,4	1.75	150,1	5.91	110,3	4.34	19,2	0.76	51,5	2.03
4S20FLE16	-20	25	-16	50,8	2.00	175,4	6.91	135,7	5.34	19,2	0.76	64,4	2.54
4S20FLE20	-20	31	-20	50,8	2.00	191,8	7.55	136,8	5.39	25,2	0.99	64,4	2.54
4S24FLE20	-24	31	-20	60,4	2.38	180,8	7.12	125,8	4.95	25,2	0.99	59,5	2.34
4S24FLE24	-24	38	-24	60,3	2.37	244,2	9.61	166,2	6.54	31,1	1.22	75,2	2.96
4S32FLE24	-32	38	-24	71,4	2.81	294,1	11.58	216,1	8.51	31,1	1.22	99,3	3.91
4S32FLE32	-32	51	-32	71,4	2.81	297,0	11.69	219,0	8.62	42,1	1.66	99,3	3.91

Spiral – 4S and 6S series

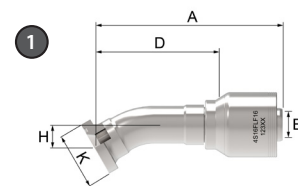

FLF

SAE Code 61 Flange (30° elbow)

PART 4S part #	HOSE SIZE INFO			DIMENSIONS									
	Terminal End Hose Size	DN	Hose size	Flange Head Dia. K Ø		A		D		EØ		H	
				mm	in	mm	in	mm	in	mm	in	mm	in
4S12FLF12	-12	19	-12	38,1	1.50	119,4	4.70	83,3	3.28	14,2	0.56	16,4	0.65
4S16FLF12	-16	19	-12	44,4	1.75	134,6	5.30	98,4	3.87	14,2	0.56	19,3	0.76
4S16FLF16	-16	25	-16	44,4	1.75	137,7	5.42	97,9	3.85	19,2	0.76	19,3	0.76
4S20FLF16	-20	25	-16	50,8	2.00	158,3	6.23	118,6	4.67	19,2	0.76	23,3	0.92
4S20FLF20	-20	31	-20	50,8	2.00	174,7	6.88	119,7	4.71	25,2	0.99	23,3	0.92
4S24FLF20	-24	31	-20	60,4	2.38	169,9	6.69	114,9	4.52	25,2	0.99	24,1	0.95
4S24FLF24	-24	38	-24	60,3	2.37	223,4	8.80	145,4	5.72	31,1	1.22	26,8	1.06
4S32FLF32	-32	51	-32	71,4	2.81	265,9	10.47	187,8	7.39	42,1	1.66	33,9	1.34

Spiral – 4S and 6S series

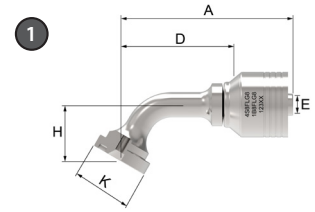

FLG

SAE Code 61 Flange (60° elbow)

PART	HOSE SIZE INFO			DIMENSIONS									
	Terminal End Hose Size	DN	Hose size	Flange Head Dia. K Ø		A		D		EØ		H	
1 4S part #				mm	in	mm	in	mm	in	mm	in	mm	in
4S12FLG12	-12	19	-12	38,1	1.50	133,9	5.27	97,7	3.85	14,2	0.56	37,6	1.48
4S16FLG12	-16	19	-12	44,4	1.75	153,2	6.03	117,1	4.61	14,2	0.56	44,7	1.76
4S16FLG16	-16	25	-16	44,4	1.75	156,4	6.16	116,6	4.59	19,2	0.76	44,7	1.76
4S20FLG16	-20	25	-16	50,8	2.00	183,3	7.22	143,5	5.65	19,2	0.76	55,8	2.20
4S20FLG20	-20	25	-20	50,8	2.00	199,7	7.86	144,7	5.70	25,2	0.99	55,8	2.20
4S24FLG20	-24	31	-20	60,4	2.38	188,1	7.41	133,0	5.24	25,2	0.99	51,7	2.04
4S24FLG24	-24	38	-24	60,3	2.37	253,3	9.97	175,3	6.90	31,1	1.22	65,2	2.57
4S32FLG32	-32	51	-32	71,4	2.81	309,1	12.17	231,1	9.10	42,1	1.66	85,8	3.38

Spiral – 4S and 6S series

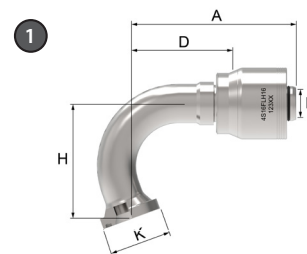

FLH

SAE Code 61 Flange (110° elbow)

PART	HOSE SIZE INFO			DIMENSIONS									
	Terminal End Hose Size	DN	Hose size	Flange Head Dia. K Ø		A		D		E Ø		H	
1 4S part #				mm	in	mm	in	mm	in	mm	in	mm	in
4S16FLH16	-16	25	-16	44,4	1.75	114,6	4.51	74,9	2.95	19,2	0.76	85,2	3.35

Spiral – 4S and 6S series

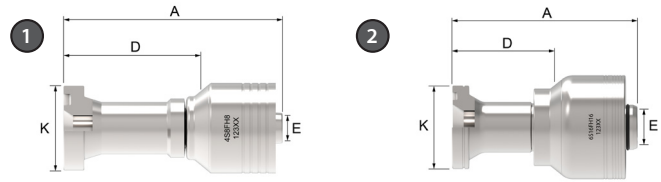

FH

SAE Code 62 Flange (straight)

PART	HOSE SIZE INFO			DIMENSIONS							
	Terminal End Hose Size	DN	Hose size	Flange Head Dia. K Ø		A		D		EØ	
1 4S part #				mm	in	mm	in	mm	in	mm	in
4S12FH12	-12	19	-12	41,3	1.63	90,7	3.57	54,5	2.15	14,2	0.56
4S16FH12	-16	19	-12	47,7	1.88	90,2	3.55	54,0	2.13	14,2	0.56
4S12FH16	-12	25	-16	41,3	1.63	96,3	3.79	56,7	2.23	14,2	0.56
4S16FH16	-16	25	-16	47,7	1.88	98,9	3.89	59,1	2.33	19,2	0.76
4S20FH16	-20	25	-16	54,0	2.13	100,8	3.97	61,0	2.40	19,2	0.76
4S16FH20	-16	31	-20	47,7	1.88	123,8	4.87	68,6	2.70	25,2	0.99
4S20FH20	-20	31	-20	54,0	2.13	123,3	4.85	68,1	2.68	25,2	0.99
4S24FH20	-24	31	-20	63,5	2.50	129,0	5.08	73,9	2.91	25,2	0.99
4S24FH24	-24	38	-24	63,5	2.50	189,6	7.46	111,6	4.39	31,1	1.22
4S32FH24	-32	38	-24	79,4	3.13	204,4	8.05	126,4	4.89	31,1	1.22
4S32FH32	-32	51	-32	79,4	3.13	202,7	7.98	124,7	4.91	42,1	1.66
2 6S part #	Terminal End Hose Size	DN	Hose size	Flange Head Dia. K Ø		A		D		EØ	
6S16FH16	-16	25	-16	47,7	1.88	98,8	3.89	59,2	2.33	19,2	0.76
6S20FH16	-20	25	-16	54,0	2.13	100,8	3.97	61,0	2.40	19,2	0.76
6S20FH20	-20	31	-20	54,0	2.13	124,0	4.88	68,1	2.68	25,2	0.99
6S24FH20	-24	31	-20	63,5	2.50	129,8	5.11	73,9	2.91	25,2	0.99
6S24FH24	-24	38	-24	63,5	2.50	189,6	7.46	111,6	4.39	31,1	1.22
6S32FH24	-32	38	-24	79,4	3.13	204,4	8.05	126,4	4.98	31,1	1.22
6S32FH32	-32	51	-32	79,4	3.13	202,7	7.98	124,7	4.91	42,1	1.66

Spiral – 4S and 6S series

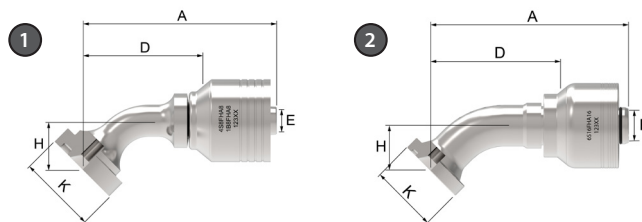

FHA

SAE Code 62 Flange (45° elbow)

PART	HOSE SIZE INFO			DIMENSIONS									
	Terminal End Hose Size	DN	Hose size	Flange Head Dia. K Ø		A		D		EØ		H	
1 4S part #				mm	in	mm	in	mm	in	mm	in	mm	in
4S12FHA12	-12	19	-12	41,3	1.63	113,8	4.48	77,6	3.06	14,2	0.56	27,0	1.06
4S16FHA12	-16	19	-12	47,7	1.88	128,0	5.04	91,7	3.61	14,2	0.56	32,0	1.26
4S12FHA16	-12	25	-16	41,3	1.63	116,9	4.60	77,2	3.04	15,1	0.59	27,0	1.06
4S16FHA16	-16	25	-16	47,7	1.88	130,9	5.15	91,2	3.59	19,2	0.76	32,0	1.26
4S20FHA16	-20	25	-16	54,0	2.13	150,2	5.91	110,5	4.35	19,2	0.76	39,0	1.54
4S20FHA20	-20	31	-20	54,0	2.13	166,6	6.56	111,6	4.39	25,2	0.99	39,0	1.54
4S24FHA20	-24	31	-20	63,5	2.50	183,2	7.21	128,2	5.05	25,2	0.99	45,0	1.77
4S24FHA24	-24	38	-24	63,5	2.50	214,1	8.43	136,1	5.36	31,1	1.22	45,0	1.77
4S32FHA24	-32	38	-24	79,4	3.13	251,0	9.88	173,0	6.81	31,1	1.22	57,5	2.26
4S32FHA32	-32	51	-32	79,4	3.13	253,9	10.00	175,9	6.93	42,1	1.66	57,5	2.26
2 6S part #	Terminal End Hose Size	DN	Hose size	Flange Head Dia. K Ø		A		D		EØ		H	
6S16FHA16	-16	25	-16	47,7	1.88	130,9	5.15	91,2	3.59	19,2	0.76	32,0	1.26
6S20FHA16	-20	25	-16	54,0	2.13	150,2	5.91	110,0	4.35	19,0	0.75	39,0	1.54
6S20FHA20	-20	31	-20	54,0	2.13	167,6	6.60	111,6	4.39	25,2	0.99	39,0	1.54
6S24FHA20	-24	31	-20	63,5	2.50	184,2	7.25	128,2	5.05	25,2	0.99	45,0	1.77
6S24FHA24	-24	38	-24	63,5	2.50	214,1	8.43	136,1	5.36	31,1	1.22	45,0	1.77
6S32FHA24	-32	38	-24	79,4	3.13	251,0	9.88	173,0	6.81	31,1	1.22	57,5	2.26
6S32FHA32	-32	51	-32	79,4	3.13	253,9	10.00	175,9	6.93	42,1	1.66	57,5	2.26

Spiral – 4S and 6S series

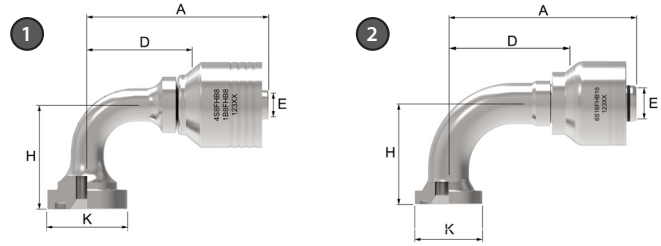

FHB

SAE Code 62 Flange (90° elbow)

PART	HOSE SIZE INFO					DIMENSIONS							
	Terminal End Hose Size	DN	Hose size	Flange Head Dia KØ		A		D		EØ		H	
1 4S part #				mm	in	mm	in	mm	in	mm	in	mm	in
4S12FHB12	-12	19	-12	41,3	1.63	108,5	4.27	72,3	2.85	14,2	0.56	59,0	2.32
4S16FHB12	-16	19	-12	47,7	1.88	122,9	4.84	86,6	3.41	14,2	0.56	71,0	2.80
4S16FHB16	-16	25	-16	47,7	1.88	125,5	4.94	86,1	3.39	19,2	0.76	71,0	2.80
4S16FHB16.120	-16	25	-16	47,7	1.88	126,0	4.96	86,2	3.39	19,2	0.76	120,0	4.72
4S20FHB16	-20	25	-16	54,0	2.13	145,3	5.72	105,4	4.15	19,2	0.76	89,0	3.50
4S16FHB20	-16	31	-20	47,7	1.88	147,1	5.79	91,9	3.62	25,2	0.99	71,0	2.80
4S20FHB20	-20	31	-20	54,0	2.13	161,5	6.36	106,5	4.19	25,2	0.99	89,0	3.50
4S20FHB20.120	-20	31	-20	54,0	2.13	161,5	6.36	106,5	4.19	25,2	0.99	120,0	4.72
4S24FHB20	-24	31	-20	63,5	2.50	178,0	7.01	123,0	4.84	25,2	0.99	104,0	4.09
4S24FHB24	-24	38	-24	63,5	2.50	208,9	8.22	130,8	5.15	31,1	1.22	104,0	4.09
4S32FHB24	-32	38	-24	79,4	3.13	247,4	9.74	169,4	9.74	31,1	1.22	138,0	5.43
4S32FHB32	-32	51	-32	79,4	3.13	250,3	9.85	172,2	6.78	42,1	1.66	138,0	5.43
2 6S part #				mm	in	mm	in	mm	in	mm	in	mm	in
6S16FHB16	-16	25	-16	47,7	1.88	125,5	4.94	86,1	3.39	19,2	0.76	71,0	2.80
6S20FHB16	-20	25	-16	54,0	2.13	145,3	5.72	105,4	4.15	19,2	0.76	89,0	3.50
6S16FHB20	-16	31	-20	47,7	1.88	147,9	5.82	91,9	3.62	25,2	0.99	71,0	2.80
6S20FHB20	-20	31	-20	54,0	2.13	162,5	6.40	106,5	4.19	25,2	0.99	89,0	3.50
6S24FHB20	-24	31	-20	63,5	2.50	179,0	7.05	123,0	4.84	25,2	0.99	104,0	4.09
6S24FHB24	-24	38	-24	63,5	2.50	208,9	8.22	130,8	5.15	31,1	1.22	104,0	4.09
6S32FHB24	-32	38	-24	79,4	3.13	247,4	9.74	169,4	6.67	31,1	1.22	138,0	5.43
6S32FHB32	-32	51	-32	79,4	3.13	250,3	9.85	172,2	6.78	42,1	1.66	138,0	5.43

Spiral – 4S and 6S series

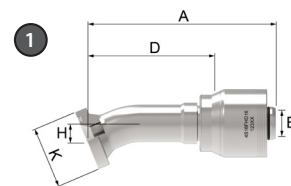

FHD

SAE Code 62 Flange (22.5° elbow)

PART ① 4S part #	HOSE SIZE INFO			DIMENSIONS									
	Terminal End Hose Size	DN	Hose size	Flange Head Dia. K Ø		A		D		E Ø		H	
				mm	in	mm	in	mm	in	mm	in	mm	in
4S16FHD16	-16	25	-16	47,7	1.88	140,0	5.51	100,1	3.94	19,2	0.76	13,5	0.53
4S20FHD16	-20	25	-16	54,0	2.13	160,9	6.33	121,2	4.77	19,2	0.76	16,3	0.64
4S32FHD32	-32	51	-32	79,4	3.13	269,6	10.61	191,5	7.54	42,1	1.66	23,5	0.93

Spiral – 4S and 6S series

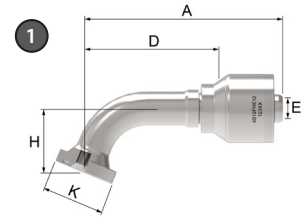

FHE

SAE Code 62 Flange (67.5° elbow)

PART	HOSE SIZE INFO			DIMENSIONS									
	Terminal End Hose Size	DN	Hose size	Flange Head Dia. K Ø		A		D		EØ		H	
① 4S part #				mm	in	mm	in	mm	in	mm	in	mm	in
4S32FHE32	-32	51	-32	79,4	3.13	297,0	11.69	219,0	8.62	42,1	1.66	99,3	3.91

Spiral – 4S and 6S series

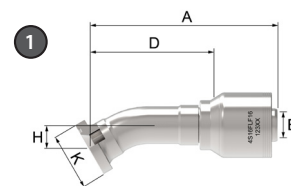

FHF

SAE Code 62 Flange (30° elbow)

PART	HOSE SIZE INFO			DIMENSIONS									
	Terminal End Hose Size	DN	Hose size	Flange Head Dia. K Ø		A		D		EØ		H	
1 4S part #				mm	in	mm	in	mm	in	mm	in	mm	in
4S24FHF20	-20	31	-20	63,5	2.50	192,6	7.58	137,6	5.42	25.2	0.99	26,8	1.06
4S32FHF32	-32	51	-32	79,4	3.13	265,8	10.47	187,8	7.39	42,1	1.66	33,9	1.34

Spiral – 4S and 6S series

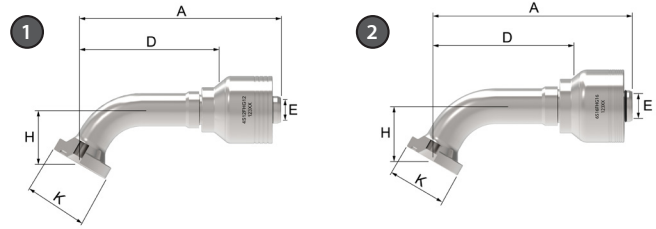

FHG

SAE Code 62 Flange (60° elbow)

PART	HOSE SIZE INFO			DIMENSIONS									
	Terminal End Hose Size	DN	Hose size	Flange Head Dia. K Ø		A		D		EØ		H	
1 4S part #				mm	in	mm	in	mm	in	mm	in	mm	in
4S12FHG12	-12	19	-12	41,3	1.63	133,9	5.27	97,7	3.85	14,2	0.56	37,6	1.48
4S16FHG16	-16	25	-16	47,7	1.88	156,4	6.16	116,6	4.59	19,2	0.76	44,6	1.76
4S32FHG32	-32	51	-32	79,4	3.13	309,1	12.17	231,1	9.10	42,1	1.66	85,8	3.38
2 6S part #	Terminal End Hose Size	DN	Hose size	Flange Head Dia. K Ø		A		D		EØ		H	
6S16FHG16	-16	25	-16	47,7	1.88	156,4	6.16	116,6	4.59	19,2	0.76	44,7	1.76
6S20FHG16	-20	25	-16	54,0	2.13	183,3	7.22	143,5	5.65	19,2	0.76	55,8	2.20
6S20FHG20	-20	31	-20	54,0	2.13	200,6	7.90	144,6	5.69	25,2	0.99	55,8	2.20

Spiral – 4S and 6S series

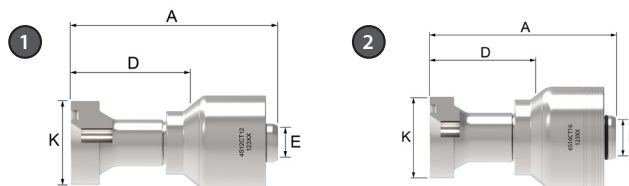

CT

CAT Flange (straight)

PART		HOSE SIZE INFO			DIMENSIONS						
1 4S part #	Terminal End Hose Size	DN	Hose size	Flange Head Dia. K Ø		A		D		EØ	
				mm	in	mm	in	mm	in	mm	in
4S12CT12	-12	19	-12	41,3	1.63	96,2	3.79	60,0	2.36	14,2	0.56
4S16CT12	-16	19	-12	47,6	1.87	94,9	3.74	58,7	2.31	14,2	0.56
4S16CT16	-16	25	-16	47,6	1.87	102,1	4.02	62,3	2.45	19,2	0.76
4S20CT16	-20	25	-16	54,0	2.13	104,8	4.13	65,0	2.56	19,2	0.76
4S20CT20	-20	31	-20	54,0	2.13	124,5	4.90	69,1	2.72	25,2	0.99
4S24CT20**	-24	31	-20	63,5	2.50	130,9	5.15	75,9	2.99	25,2	0.99
4S24CT24	-24	38	-24	63,5	2.50	195,0	7.68	117,0	4.61	31,1	1.22
4S32CT24	-32	38	-24	79,4	3.13	206,0	8.11	128,0	5.04	31,1	1.22
4S32CT32	-32	51	-32	79,4	3.13	208,9	8.22	130,9	5.15	42,1	1.66
2 6S part #	Terminal End Hose Size	DN	Hose size	Flange Head Dia. K Ø		A		D		EØ	
				mm	in	mm	in	mm	in	mm	in
6S16CT16	-16	25	-16	47,6	1.87	102,1	4.02	62,3	2.45	19,2	0.76
6S20CT16	-20	25	-16	54,0	2.13	104,8	4.13	65,0	2.56	19,2	0.76
6S20CT20	-20	31	-20	54,0	2.13	125,2	4.93	69,1	2.72	25,2	0.99
6S24CT20	-24	31	-20	63,5	2.50	131,8	5.19	75,9	2.99	25,2	0.99
6S24CT24	-24	38	-24	63,5	2.50	195,0	7.68	117,0	4.61	31,1	1.22
6S32CT24	-32	38	-24	79,4	3.13	206,0	8.11	128,1	5.04	31,1	1.22
6S32CT32	-32	51	-32	79,4	3.13	208,9	8.22	130,9	5.15	42,1	1.66

Spiral – 4S and 6S series

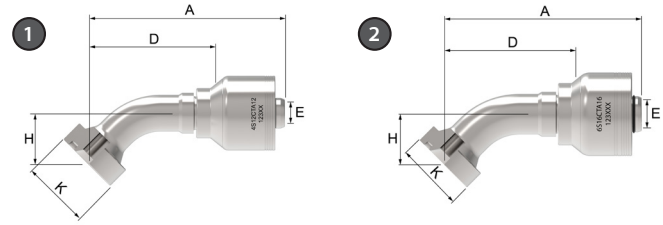

CTA

CAT Flange (45° elbow)

PART		HOSE SIZE INFO				DIMENSIONS							
1 4S part #	Terminal End Hose Size	DN	Hose size	Flange Head Dia KØ		A		D		EØ		H	
				mm	in	mm	in	mm	in	mm	in	mm	in
4S12CTA12	-12	19	-12	41,3	1,63	117,7	4.63	81,5	3.21	14,2	0.56	30,9	1.22
4S16CTA12	-16	19	-12	47,6	1,87	131,2	5.17	95,0	3.74	14,2	0.56	35,3	1.39
4S16CTA16	-16	25	-16	47,6	1,87	134,3	5.29	94,6	3.72	19,2	0.76	35,3	1.39
4S20CTA16	-20	25	-16	54,0	2,13	153,0	6.02	113,2	4.46	19,2	0.76	41,8	1.65
4S20CTA20	-20	31	-20	54,0	2,13	169,4	6.67	114,3	4.50	25,2	0.99	41,8	1.65
4S24CTA20**	-24	31	-20	63,5	2.50	185,3	7.30	129,1	5.08	25,2	0.99	46,2	1.82
4S24CTA24	-24	38	-24	63,5	2.50	215,2	8.47	137,2	5.40	31,1	1.22	46,2	1.82
4S32CTA32	-32	51	-32	79,4	3.13	255,1	10.04	177,0	6.97	42,1	1.66	58,7	1.31
2 6S part #	Terminal End Hose Size	DN	Hose size	Flange Head Dia KØ		A		D		EØ		H	
				mm	in	mm	in	mm	in	mm	in	mm	in
6S16CTA16	-16	25	-16	47,6	1,87	134,3	5.29	94,6	3.72	19,2	0.76	35,3	1.39
6S20CTA16	-20	25	-16	54,0	2,13	153,0	6.02	113,2	4.46	19,2	0.76	41,8	1.65
6S20CTA20	-20	31	-20	54,0	2,13	170,3	6.70	114,3	4.50	25,2	0.99	41,8	1.65
6S24CTA20	-24	31	-20	63,5	2.50	185,3	7.30	129,1	5.08	25,2	0.99	46,2	1.82
6S24CTA24	-24	38	-24	63,5	2.50	215,2	8.47	137,2	5.40	31,1	1.22	46,2	1.82
6S32CTA24	-32	38	-24	79,4	3.13	252,2	9.93	174,2	6.86	31,1	1.22	58,7	2.31
6S32CTA32	-32	51	-32	79,4	3.13	255,1	10.04	177,0	6.97	42,1	1.66	58,7	2.31

Spiral – 4S and 6S series

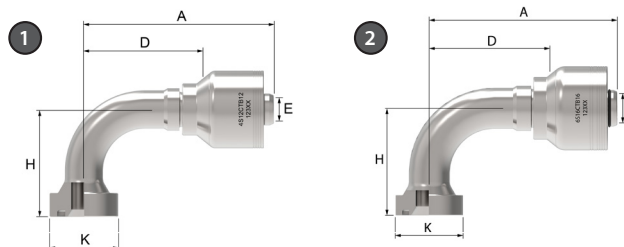

CTB

CAT Flange (90° elbow)

PART	HOSE SIZE INFO					DIMENSIONS							
	Terminal End Hose Size	DN	Hose size	Flange Head Dia KØ		A		D		EØ		H	
1 4S part #				mm	in	mm	in	mm	in	mm	in	mm	in
4S12CTB12	-12	19	-12	41,3	1.63	108,5	4.27	72,3	2.85	14,2	0.56	64,5	2.54
4S16CTB12	-16	19	-12	47,6	1.87	122,8	4.83	86,6	3.41	14,2	0.56	75,7	2.98
4S16CTB16	-16	25	-16	47,6	1.87	126,0	4.96	86,2	3.39	19,2	0.76	75,7	2.98
4S20CTB16	-20	25	-16	54,0	2.13	145,2	5.72	105,4	4.15	19,2	0.76	92,9	3.66
4S20CTB20	-20	31	-20	54,0	2.13	161,5	6.36	106,5	4.19	25,2	0.99	92,9	3.66
4S24CTB20	-24	31	-20	63,5	2.50	179,0	7.05	123,0	4.84	25,2	0.99	105,6	4.16
4S24CTB24	-24	38	-24	63,5	2.50	208,9	8.22	130,9	5.15	31,1	1.22	105,7	4.16
4S32CTB32	-32	51	-32	79,4	3.13	250,3	9.85	172,2	6.78	42,1	1.66	139,7	5.50
2 6S part #	Terminal End Hose Size	DN	Hose size	Flange Head Dia KØ		A		D		EØ		H	
6S16CTB16	-16	25	-16	47,6	1.87	126,0	4.96	86,2	3.39	19,2	0.76	75,7	2.98
6S20CTB16	-20	25	-16	54,0	2.13	145,2	5.72	105,4	4.15	19,2	0.76	92,9	3.66
6S20CTB20	-20	31	-20	54,0	2.13	162,5	6.40	106,5	4.19	25,2	0.99	92,9	3.66
6S24CTB20	-24	31	-20	63,5	2.50	179,0	7.05	123,0	4.84	25,2	0.99	105,6	4.16
6S24CTB24	-24	38	-24	63,5	2.50	208,9	8.22	130,9	5.15	31,1	1.22	105,7	4.16
6S32CTB24	-32	38	-24	69,6	2.74	247,4	9.74	169,4	6.67	31,1	1.22	139,7	5.50
6S32CTB32	-32	51	-32	79,4	3.13	250,3	9.85	172,2	6.78	42,1	1.66	139,7	5.50

Spiral – 4S and 6S series

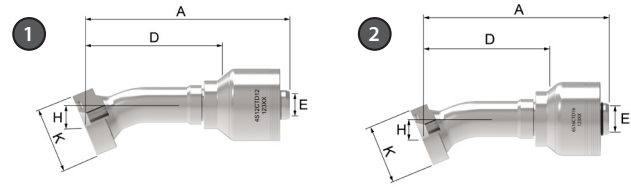

CTD

CAT Flange (22.5° elbow)

PART	HOSE SIZE INFO					DIMENSIONS							
	Terminal End Hose Size	DN	Hose size	Flange Head Dia KØ		A		D		EØ		H	
1 4S part #				mm	in	mm	in	mm	in	mm	in	mm	in
4S12CTD12	-12	19	-12	41,3	1.63	126,2	4.97	90,2	3.55	14,2	0.56	13,6	0.54
4S16CTD16	-16	25	-16	47,6	1.87	144,2	5.68	104,4	4.11	19,2	0.76	15,3	0.60
4S20CTD16	-20	25	-16	54,0	2.13	164,5	6.48	124,8	4.91	19,2	0.76	17,8	0.70
4S20CTD20**	-20	31	-20	54,0	2.13	181,9	7.16	125,9	4.96	25,2	0.99	17,8	0.70
4S24CTD20**	-24	31	-20	63,5	2.50	198,0	7.80	142,0	5.59	25,2	0.99	19,4	0.76
4S24CTD24	-24	38	-24	63,5	2.50	227,9	8.97	149,9	5.90	31,1	1.22	19,4	0.76
4S32CTD32	-32	51	-32	79,4	3.13	271,1	10.67	193,0	7.60	42,1	1.66	24,2	0.95
2 6S part #	Terminal End Hose Size	DN	Hose size	Flange Head Dia KØ		A		D		EØ		H	
6S16CTD16	-16	25	-16	47,6	1.87	144,2	5.68	104,4	4.11	19,2	0.76	15,3	0.60
6S20CTD16	-20	25	-16	54,0	2.13	164,5	6.48	124,8	4.91	19,2	0.76	17,8	0.70
6S20CTD20	-20	31	-20	54,0	2.13	181,9	7.16	125,9	4.96	25,2	0.99	17,8	0.70
6S24CTD20	-24	31	-20	63,5	2.50	198,0	7.80	142,0	5.59	25,2	0.99	19,4	0.76
6S24CTD24	-24	38	-24	63,5	2.50	227,9	8.97	149,9	5.90	31,1	1.22	19,4	0.76
6S32CTD32	-32	51	-32	79,4	3.13	271,1	10.67	193,0	7.60	42,1	1.66	24,2	0.95

Spiral – 4S and 6S series

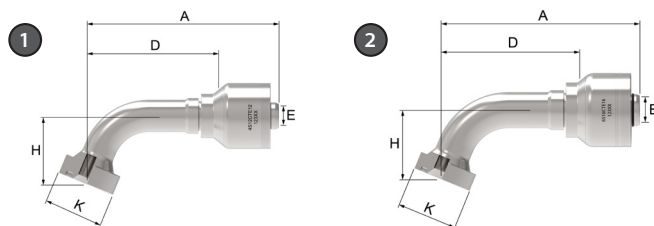

CTE

CAT Flange (67.5° elbow)

PART	HOSE SIZE INFO					DIMENSIONS							
	Terminal End Hose Size	DN	Hose size	Flange Head Dia KØ		A		D		EØ		H	
1 4S part #				mm	in	mm	in	mm	in	mm	in	mm	in
4S12CTE12	-12	19	-12	41,3	1.63	130,7	5.15	94,5	3.72	14,2	0.56	48,3	1.90
4S16CTE16	-16	25	-16	47,6	1.87	151,9	5.98	112,2	4.42	19,2	0.76	55,8	2.20
4S20CTE16	20	25	-16	54,0	2.13	176,9	6.96	137,1	5.40	19,2	0.76	68,1	2.68
4S20CTE20**	-20	31	-20	54,0	2.13	194,2	7.65	138,3	5.44	25,2	0.99	68,1	2.68
4S24CTE20**	-24	31	-20	63,5	2.50	214,9	8.46	159,0	6.26	25,2	0.99	76,8	3.02
4S24CTE24	-24	38	-24	63,5	2.50	244,8	9.64	166,8	6.57	31,1	1.22	76,8	3.02
4S32CTE32	-32	51	-32	79,4	3.13	297,6	11.72	219,6	8.65	42,1	1.66	100,8	3.97
2 6S part #	Terminal End Hose Size	DN	Hose size	Flange Head Dia KØ		A		D		EØ		H	
6S16CTE16	-16	25	-16	47,6	1.87	151,9	5.98	112,2	4.42	19,2	0.76	55,8	2.20
6S20CTE16	-20	25	-16	54,0	2.13	176,9	6.96	137,1	5.40	19,2	0.76	68,1	2.68
6S20CTE20	-20	31	-20	54,0	2.13	194,2	7.65	138,3	5.44	25,2	0.99	68,1	2.68
6S24CTE20	-24	31	-20	63,5	2.50	214,9	8.46	159,0	6.26	25,2	0.99	76,8	3.02
6S24CTE24	-24	38	-24	63,5	2.50	244,8	9.64	166,8	6.57	31,1	1.22	76,8	3.02
6S32CTE24	-32	38	-24	79,4	3.13	294,7	11.60	216,7	8.53	31,1	1.22	100,8	3.97
6S32CTE32	-32	51	-32	79,4	3.13	297,6	11.72	219,6	8.65	42,1	1.66	100,8	3.97

Spiral – 4S and 6S series

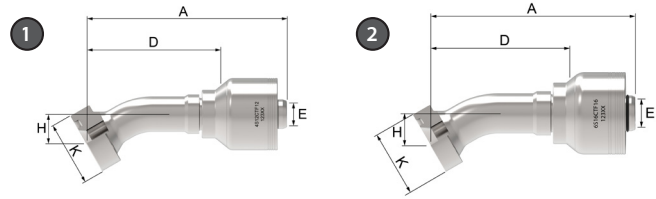

CTF

CAT Flange (30° elbow)

PART	HOSE SIZE INFO			DIMENSIONS									
	Terminal End Hose Size	DN	Hose size	Flange Head Dia. K Ø		A		D		EØ		H	
1 4S part #				mm	in	mm	in	mm	in	mm	in	mm	in
4S12CTF12	-12	19	-12	41,3	1.63	124,2	4.89	88,0	3.46	14,2	0.56	19,1	0.75
4S16CTF16	-16	25	-16	47,6	1.87	141,7	5.58	102,0	4.02	19,2	0.76	21,6	0.85
4S20CTF16	-20	25	-16	54,0	2.13	161,7	6.37	122,0	4.80	19,2	0.76	25,3	1.00
4S20CTF20**	-20	31	-20	54,0	2.13	179,1	7.05	123,1	4.85	25,2	0.99	25,3	1.00
4S24CTF20**	-24	31	-20	63,5	2.50	194,9	7.67	138,9	5.47	25,2	0.99	27,7	1.09
4S24CTF24	-24	38	-24	63,5	2.50	224,8	8.85	146,8	5.78	31,1	1.22	27,7	1.09
4S32CTF32	-32	51	-32	79,4	3.13	267,3	10.52	189,2	7.45	42,1	1.66	34,8	1.37
2 6S part #				mm	in	mm	in	mm	in	mm	in	mm	in
6S16CTF16	-16	25	-16	47,6	1.87	141,7	5.58	102,0	4.02	19,2	0.76	21,6	0.85
6S20CTF16	-20	25	-16	54,0	2.13	161,7	6.37	122,0	4.80	19,2	0.76	25,3	1.00
6S20CTF20	-20	31	-20	54,0	2.13	179,1	7.05	123,1	4.85	25,2	0.99	25,3	1.00
6S24CTF20	-24	31	-20	63,5	2.50	194,9	7.67	138,9	5.47	25,2	0.99	27,7	1.09
6S24CTF24	-24	38	-24	63,5	2.50	224,8	8.85	146,8	5.78	31,1	1.22	27,7	1.09
6S32CTF24	-32	38	-24	79,4	3.13	264,3	10.41	186,3	7.34	31,1	1.22	34,8	1.37
6S32CTF32	-32	51	-32	79,4	3.13	267,3	10.52	189,2	7.45	42,1	1.66	34,8	1.37

Spiral – 4S and 6S series

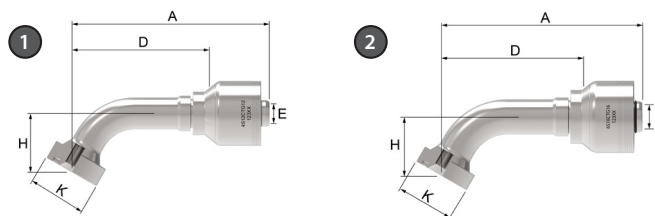

CTG

CAT Flange (60° elbow)

PART	HOSE SIZE INFO			DIMENSIONS									
	Terminal End Hose Size	DN	Hose size	Flange Head Dia. K Ø		A		D		EØ		H	
1 4S part #				mm	in	mm	in	mm	in	mm	in	mm	in
4S12CTG12	-12	19	-12	41,3	1.63	136,6	5.38	100,5	3.96	14,2	0.56	42,3	1.67
4S16CTG16	-16	25	-16	47,6	1.87	158,8	6.25	119,0	4.69	19,2	0.76	48,7	1.92
4S20CTG16	-20	25	-16	54,0	2.13	185,2	7.29	145,5	5.73	19,2	0.76	59,2	2.33
4S20CTG20**	-20	31	-20	54,0	2.13	202,6	7.98	146,6	5.77	25,2	0.99	59,2	2.33
4S24CTG20**	-24	31	-20	63,5	2.50	224,3	8.83	168,3	6.63	25,2	0.99	66,6	2.62
4S24CTG24	-24	38	-24	63,5	2.50	254,2	10.01	176,2	6.94	31,1	1.22	66,6	2.62
4S32CTG32	-32	51	-32	79,4	3.13	310,0	12.20	231,9	9.13	42,1	1.66	87,3	3.44
2 6S part #	Terminal End Hose Size	DN	Hose size	Flange Head Dia. K Ø		A		D		EØ		H	
6S16CTG16	-16	19	-12	41,3	1.63	130,7	5.15	95,5	3.72	14,2	0.56	48,3	1.90
6S20CTG16	-20	25	-16	54,0	2.13	185,2	7.29	145,5	5.73	19,2	0.76	59,2	2.33
6S20CTG20	-20	31	-20	54,0	2.13	202,6	7.98	146,6	5.77	25,2	0.99	59,2	2.33
6S24CTG20	-24	31	-20	63,5	2.50	224,3	8.83	168,3	6.63	25,2	0.99	66,6	2.62
6S24CTG24	-24	38	-24	63,5	2.50	254,2	10.01	176,2	6.94	31,1	1.22	66,6	2.62
6S32CTG24	-32	38	-24	79,4	3.13	307,0	12.09	229,0	9.02	31,1	1.22	87,3	3.44
6S32CTG32	-32	51	-32	79,4	3.13	310,0	12.20	231,9	9.13	42,1	1.66	87,3	3.44

Spiral – 4S and 6S series

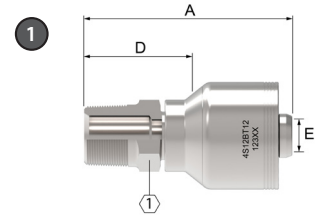

BT

BSP Male tapered rigid (straight)

PART ① 4S part #	HOSE SIZE INFO			DIMENSIONS								
	Terminal End Hose Size	DN	Hose size	Thread		A		D		EØ		① mm
						mm	in	mm	in	mm	in	mm
4S12BT12	-12	19	-12	R 3/4		84,0	3.31	47,7	1.88	14,2	0.56	27,0
4S16BT16	-16	25	-16	R 1		94,9	3.74	55,2	2.17	19,2	0.75	36,0
4S20BT20	-20	31	-20	R 1 1/4		118,4	4.66	63,3	2.49	25,2	0.99	46,0

"R" as part of thread size is ISO designation for tapered thread.

Spiral – 4S and 6S series

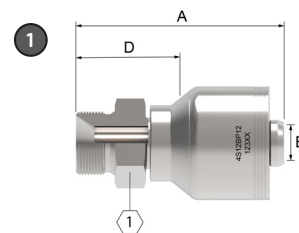

BP

Male parallel rigid (60° cone seat straight)

PART	HOSE SIZE INFO			DIMENSIONS								
	Terminal End Hose Size	DN	Hose size	Thread	A		D		EØ		1	
1 4S part #					mm	in	mm	in	mm	in	mm	in
4S12BP12	-12	19	-12	G 3/4	79,6	3.13	43,4	1.71	14,2	0.56	32,0	27,0
4S16BP16	-16	25	-16	G 1	89,8	3.53	50,1	1.97	19,2	0.75	41,0	36,0
4S20BP20	-20	31	-20	G 1 1/4	109,7	4.32	54,5	2.15	25,1	0.99	50,0	46,0

"G" as part of thread size is ISO designation for parallel thread.

Spiral – 4S and 6S series

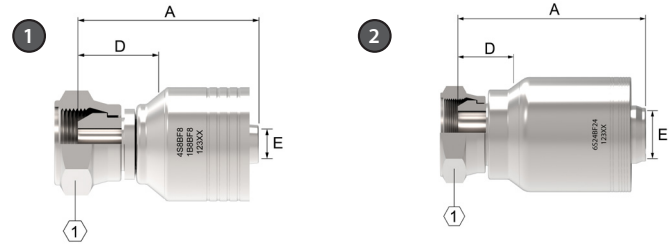

BF

Female BSPP swivel (60° cone street straight)

PART	HOSE SIZE INFO			DIMENSIONS							
	Terminal End Hose Size	DN	Hose size	Thread	A		D		EØ		1
1 4S part #					mm	in	mm	in	mm	in	mm
4S12BF12	-12	19	-12	G 3/4	66,2	2.61	29,9	1.18	14,2	0.56	32,0
4S16BF12	-16	19	-12	G 1	68,7	2.70	32,3	1.27	14,2	0.56	41,0
4S16BF16	-16	25	-16	G 1	71,0	2.80	32,3	1.27	19,2	0.76	41,0
4S20BF16	-20	25	-16	G 1 1/4	72,5	2.85	32,7	1.29	19,2	0.76	50,0
4S20BF20	-20	31	-20	G 1 1/4	82,8	3.26	32,7	1.29	25,2	0.99	50,0
4S24BF24	-24	38	-24	G 1 1/2	117,9	4.64	39,8	1.57	31,1	1.22	55,0
4S32BF32	-32	51	-32	G 2	121,0	4.76	43,0	1.69	42,1	1.66	70,0
2 6S part #	Terminal End Hose Size	DN	Hose size	Thread	A		D		EØ		1
6S24BF24	-24	38	-24	G 1 1/2	117,9	4.64	39,8	1.57	31,1	1.22	55,0
6S32BF32	-32	51	-32	G 2	121,0	4.76	43,0	1.69	42,1	1.66	70,0

"G" as part of thread size is ISO designation for parallel thread.

Spiral – 4S and 6S series

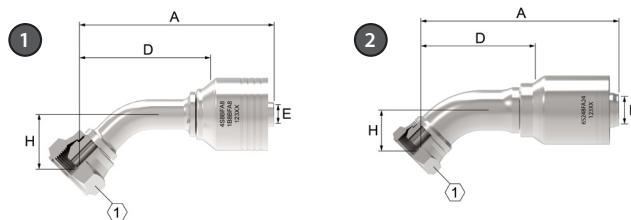

BFA

Female BSPP swivel (60° cone seat 45° elbow)

PART		HOSE SIZE INFO			DIMENSIONS								
① 4S part #	Terminal End Hose Size	DN	Hose size	Thread	A		D		EØ		H		① mm
					mm	in	mm	in	mm	in	mm	in	
4S12BFA12	-12	19	-12	G 3/4	112,3	4.42	75,9	2.99	14,2	0.56	26,0	1.02	32,0
4S16BFA12	-16	19	-12	G 1	115,8	4.56	79,5	3.13	14,2	0.56	30,0	1.18	41,0
4S16BFA16	-16	25	-16	G 1	130,3	5.13	90,6	3.57	19,2	0.76	30,0	1.18	41,0
4S20BFA16	-20	25	-16	G 1 1/4	133,0	5.24	93,4	3.68	19,2	0.76	34,0	1.34	50,0
4S20BFA20	-20	31	-20	G 1 1/4	149,5	5.89	99,1	3.90	25,2	0.99	34,0	1.34	50,0
4S24BFA24	-24	38	-24	G 1 1/2	208,3	8.20	130,3	5.13	31,1	1.22	42,4	1.67	55,0
4S32BFA32	-32	51	-32	G 2	248,4	9.78	170,4	6.71	42,1	1.66	54,1	2.13	70,0
② 6S part #	Terminal End Hose Size	DN	Hose size	Thread	A		D		EØ		H		① mm
					mm	in	mm	in	mm	in	mm	in	
6S24BFA24	-24	38	-24	G 1 1/2	208,3	8.20	130,3	5.13	31,1	1.22	42,4	1.67	55,0
6S32BFA32	-32	51	-32	G 2	248,4	9.78	170,4	6.71	42,1	1.66	54,1	2.13	70,0

G as part of thread size is ISO designation for parallel thread.

Spiral – 4S and 6S series

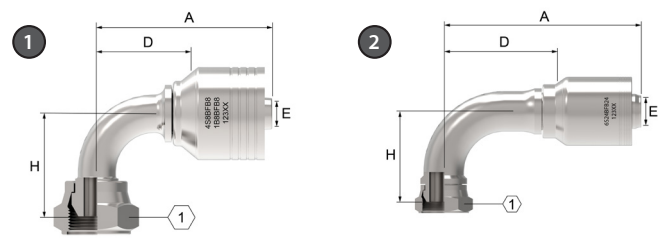

BFB

Female BSPP swivel (60° cone seat 90° elbow)

PART	HOSE SIZE INFO			DIMENSIONS									
	Terminal End Hose Size	DN	Hose size	Thread	A		D		EØ		H		1
4S part #					mm	mm	in	mm	in	mm	in	mm	in
4S12BFB12	-12	19	-12	G 3/4	105,9	4.17	69,6	2.74	14,2	0.56	57,0	2.24	32,0
4S16BFB12	-16	19	-12	G 1	105,9	4.17	69,6	2.74	14,2	0.56	68,0	2.68	41,0
4S16BFB16	-16	25	-16	G 1	125,5	4.94	85,8	3.38	19,2	0.76	68,0	2.68	41,0
4S20BFB16	-20	25	-16	G 1 1/4	125,5	4.94	85,8	3.38	19,2	0.76	79,0	3.11	50,0
4S20BFB20	-20	31	-20	G 1 1/4	145,0	5.71	95,0	3.74	25,2	0.99	79,0	3.11	50,0
4S24BFB24	-24	38	-24	G 1 1/2	205,1	8.07	127,0	5.00	31,1	1.22	98,6	3.88	55,0
4S32BFB32	-32	51	-32	G 2	245,7	9.67	167,6	6.60	42,1	1.66	125,3	4.93	70,0
6S part #	Terminal End Hose Size	DN	Hose size	Thread	A		D		EØ		H		1
6S24BFB24	-24	38	-24	G 1 1/2	205,1	8.07	127,0	5.00	31,1	1.22	98,6	3.88	55,0
6S32BFB32	-32	51	-32	G 2	245,7	9.67	167,6	6.60	42,1	1.66	125,3	4.93	70,0

"G" as part of thread size is ISO designation for parallel thread.

Spiral – 4S and 6S series

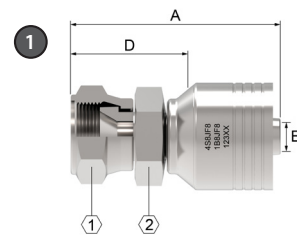

JF

JIS Female swivel (30° flare seat straight)

PART	HOSE SIZE INFO			DIMENSIONS									
	Terminal End Hose Size	DN	Hose size	Thread	A		D		EØ		1		2
1 4S part #					mm	in	mm	in	mm	in	mm	in	mm
4S12JF12	-12	19	-12	G 3/4	62,4	2.46	26,2	1.03	14,2	0.56	30,0	1 3/16	32,0
4S16JF16	-16	25	-16	G 1	66,6	2.62	26,8	1.06	19,2	0.76	41,0	1 5/8	41,0
4S20JF20	-20	31	-20	G 1 1/4	85,5	3.37	30,2	1.19	25,2	0.99	46,0	1 13/16	50,0

*"G" as part of thread size is ISO designation for parallel thread.

Spiral – 4S and 6S series

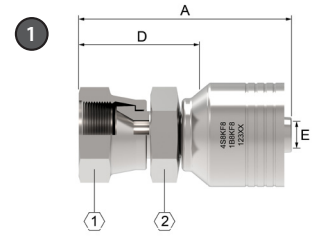

KF

Komatsu female swivel (30° flare seat straight)

PART ① 4S part #	HOSE SIZE INFO			DIMENSIONS									
	Terminal End Hose Size	DN	Hose size	Thread	A		D		EØ		①		②
				in	mm	in	mm	in	mm	in	mm	in	mm
4S12KF12	-12	19	-12	M30X1.5	62,4	2.46	26,2	1.03	14,2	0.56	30,0	1 3/16	36,0
4S16KF16	-16	25	-16	M33X1.5	66,6	2.62	26,8	1.06	19,2	0.76	41,0	1 5/8	41,0
4S20KF20	-20	31	-20	M36X1.5	85,5	3.37	30,2	1.19	25,2	0.99	46,0	1 13/16	46,0

Spiral – 4S and 6S series

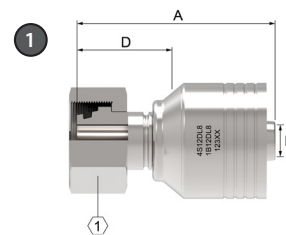

DL

Female swivel DIN 24° seat (l.Rh DKO light straight)

PART	HOSE SIZE INFO			DIMENSIONS								
	4S part #	Tube O.D.	DN	Hose size	Thread	A		D		EØ		1
					mm	mm	in	in	mm	in	mm	in
4S20DL12	22	19	-12	M30X2	76,0	2,99	39,7	1,56	14,2	0,56	36,0	
4S25DL16	28	25	-16	M36X2	79,7	3,14	40,3	1,59	19,2	0,76	41,0	
4S32DL20	35	35	-20	M45X2	100,5	3,96	45,5	1,79	25,2	0,99	50,0	

Spiral – 4S and 6S series

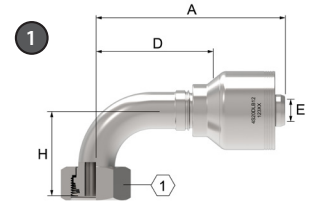

DLB

I.Rh DKO (light) 90° elbow

PART	HOSE SIZE INFO			DIMENSIONS										
	4S part #	Tube O.D.	DN	Hose size	Thread	A		D		EØ		H		1
					mm	mm	in	in	mm	in	mm	in	mm	mm
4S20DLB12	22	19	-12	M30X2	106,1	4.18	69,8	1.75	14,2	0.56	50,7	2.00	36,0	
4S32DLB20	28	25	-20	M45X2	154,2	6.07	99,2	3.90	25.2	0.99	79,0	3.11	41,0	

Spiral – 4S and 6S series

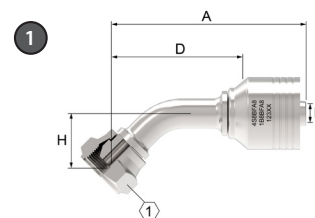

EK

Male DIN 24° Seat Rigid (S.Rh. DKO - Heavy Straight)

PART	HOSE SIZE INFO			DIMENSIONS								
	4S part #	Tube O.D.	DN	Hose size	Thread	A		D		EØ		①
					in	mm	in	in	mm	in	mm	in
4S20EK12	25	19	-12	M36X2	78,6	3.09	42,3	1.67	14,2	0.56	41,0	
4S25EK16	30	25	-16	M42X2	83,7	3.30	44,0	1.73	19,2	0.75	46,0	
4S32EK20	38	31	-20	M52X2	106,9	4.21	51,7	2.04	25,2	0.99	55,0	

Spiral – 4S and 6S series

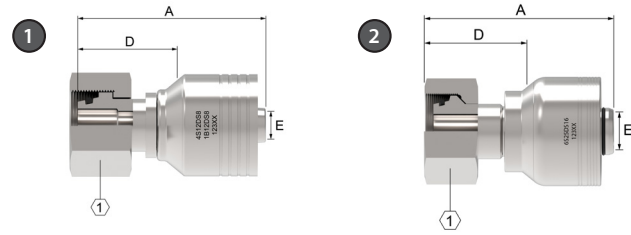

DS

Female Swivel DIN 24° seat (S.RH. DKO - Heavy Straight)

PART	HOSE SIZE INFO			DIMENSIONS								
1 4S part #	Tube O.D.	DN	Hose size	Thread	A		D		EØ		⊕	
				mm	mm	in	in	mm	in	mm	mm	
	4S16DS12	16	19	-12	M30X2	73,7	2.90	37,4	1.47	14,2	0.56	36,0
	4S20DS12	20	19	-12	M36X2	86,6	3.41	50,3	1.98	14,2	0.56	46,0
	4S25DS12	25	19	-12	M42X2	88,2	3.47	51,9	2.04	14,2	0.56	50,0
	4S25DS16	30	25	-16	M42X2	91,1	3.59	51,4	2.02	19,2	0.76	50,0
	4S32DS16	38	25	-16	M52X2	94,5	3.72	55,3	2.18	19,2	0.76	60,0
	4S25DS20	30	31	-20	M42X2	96,6	3.80	41,6	1.64	22,1	0.87	50,0
	4S32DS20	38	31	-20	M52X2	111,5	4.39	56,5	2.22	25,2	0.99	60,0
	2 6S part #	Terminal End Hose Size	DN	Hose size	Thread	A		D		EØ		⊕
6S25DS16		30	25	-16	M42X2	91,1	3.59	51,4	2.02	19,2	0.76	50,0
6S32DS16		38	25	-16	M52X2	95,0	3.74	55,3	2.18	19,2	0.76	60,0
6S32DS20	38	31	-20	M52X2	112,5	4.43	56,5	2.22	25,2	0.99	60,0	

Spiral – 4S and 6S series

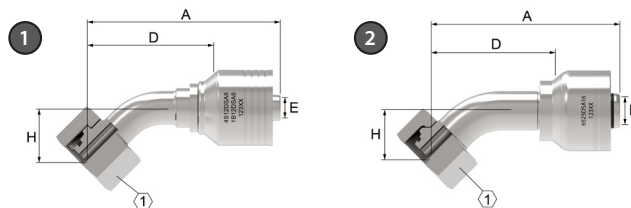

DSA

Female Swivel DIN 24° Seat (S.Rh. DKO - Heavy 45° elbow)

PART	HOSE SIZE INFO			DIMENSIONS									
1					A		D		EØ		H		
4S part #	Tube O.D.	DN	Hose size	Thread	mm	in	in	mm	in	mm	in	mm	in
4S20DSA12	25	19	-12	M36X2	116,7	4.59	80,4	3.17	14,2	0.56	32,0	1.26	46,0
4S25DSA12	30	19	-12	M42X2	130,8	5.15	94,4	3.72	14,2	0.56	35,0	1.38	50,0
4S25DSA16	30	25	-16	M42X2	134,2	5.28	94,4	3.72	19,2	0.76	35,0	1.38	50,0
4S32DSA16	38	25	-16	M52X2	145,1	5.71	105,3	4.15	19,2	0.76	39,0	1.54	60,0
4S32DSA20	38	31	-20	M52X2	161,3	6.35	106,3	4.19	25,2	0.99	39,0	1.54	60,0
2					A		D		EØ		H		
6S part #	Tube O.D.	DN	Hose size	Thread	mm	in	in	mm	in	mm	in	mm	in
6S25DSA16	30	25	-16	M42X2	134,1	5.28	94,4	3.72	19,2	0.76	35,0	1.38	50,0
6S32DSA16	38	25	-16	M52X2	145,1	5.71	105,3	4.15	19,2	0.76	39,0	1.54	60,0
6S32DSA20	38	31	-20	M52X2	162,4	6.39	106,3	4.19	25,2	0.99	39,0	1.54	60,0

Spiral – 4S and 6S series

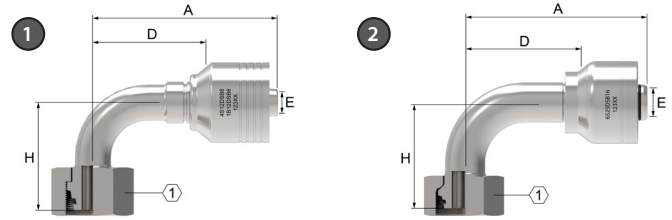

DSB

Female Swivel DIN 24° Seat (S.Rh. DKO - Heavy 90° elbow)

PART		HOSE SIZE INFO			DIMENSIONS									
①	4S part #	Tube O.D.	DN	Hose size	Thread	A		D		EØ		H		①
						mm	mm	in	mm	in	mm	in	mm	
	4S20DSB12	25	19	-12	M36X2	103,9	4.09	67,7	2.67	14,2	0.56	65,0	2.56	46,0
	4S25DSB12	30	19	-12	M42X2	122,7	4.83	86,4	3.40	14,2	0.56	76,0	2.99	50,0
	4S25DSB16	30	25	-16	M42X2	124,5	4.90	84,8	3.34	19,2	0.76	76,0	2.99	50,0
	4S32DSB16	38	25	-16	M52X2	136,7	5.38	97,0	3.82	19,2	0.76	89,0	3.50	60,0
	4S32DSB20	38	31	-20	M52X2	153,0	6.02	98,0	3.86	25,2	0.99	89,0	3.50	60,0
②	6S part #	Tube O.D.	DN	Hose size	Thread	A		D		EØ		H		①
						mm	mm	in	mm	in	mm	in	mm	
	6S25DSB16	30	25	-16	M42X2	124,5	4.90	84,8	3.34	19,2	0.76	76,0	2.99	50,0
	6S32DSB16	38	25	-16	M52X2	136,7	5.38	97,0	3.82	19,2	0.76	89,0	3.50	60,0
	6S32DSB20	38	31	-20	M52X2	154,2	6.07	98,0	3.86	25,2	0.99	89,0	3.50	60,0

Aeroquip by Danfoss

Spiral fittings

1W series



Spiral – 1W series

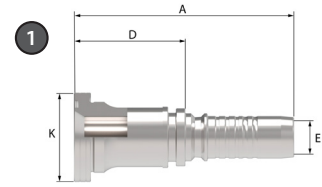

FH

Straight SAE Code 62 Flange

PART	HOSE SIZE INFO				DIMENSIONS					
	1W part #	Flange head Dia. K Ø		DN	Hose size	A		D		EØ
	mm	in			mm	in	in	mm	in	mm
1W12FH12	41,3	1.62	19	-12	110,6	4.35	58,6	2.31	15,1	0.59
1W16FH16	47,6	1.88	25	-16	134,0	5.28	67,4	2.65	19,6	0.77
1W20FH20*	54,0	2.13	31	-20	145,2	5.72	70,3	2.77	25,5	1.00
1W24FH24	63,5	2.5	38	-24	203	7.99	104,5	4.11	30	1.18
1W32FH32	79,4	3.126	51	-32	200,8	7.91	92,4	3.64	42,1	1.66

* Requires separate installation of 2 ea. p/n 05.071-27.30x2.40 O-rings (must be ordered separately). O-rings must be installed with PAG oil (only) prior to crimping.

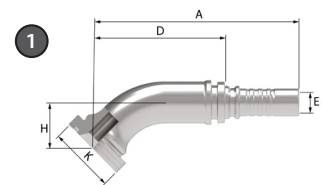

FHA

45° SAE Code 62 Flange Elbow

PART	HOSE SIZE INFO				DIMENSIONS					
	1W part #	Flange head Dia. K Ø		DN	Hose size	A		D		H
	mm	in			mm	in	mm	in	mm	in
1W12FHA12	41,3	1.62	19	-12	130,1	5.12	78,1	3.07	27,0	1.06
1W16FHA16	47,6	1.88	25	-16	160,6	6.32	94,0	3.70	31,0	1.22
1W20FHA20*	54,0	2.13	31	-20	190,0	7.48	115,1	4.53	39,0	1.54

* Requires separate installation of 2 ea. p/n 05.071-27.30x2.40 O-rings (must be ordered separately). O-rings must be installed with PAG oil (only) prior to crimping.

Spiral – 1W series

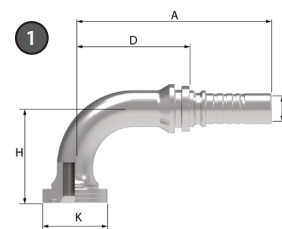

FHB

90° SAE Code 62 Flange Elbow

PART	HOSE SIZE INFO				DIMENSIONS					
	1W part #	Flange head Dia. K Ø		DN	Hose size	A		D		EØ
	mm	in			mm	in	mm	in	mm	in
1W12FHB12	41,3	1.62	19	-12	124,8	4,91	72,8	2,87	59,0	2,32
1W16FHB16	47,6	1.88	25	-16	155,6	6,13	89,0	3,50	71,0	2,80
1W20FHB20*	54,0	2.13	31	-20	185,0	7,28	110,1	4,33	89,0	3,50

* Requires separate installation of 2 ea. p/n 05.071-27.30x2.40 O-rings (must be ordered separately). O-rings must be installed with PAG oil (only) prior to crimping.

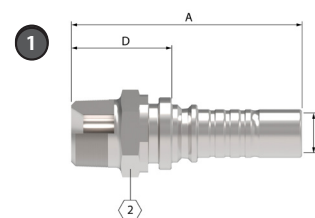

MP

90° SAE Code 62 Flange Elbow

PART	HOSE SIZE INFO				DIMENSIONS						
	1W part #	Terminal hose end size		DN	Hose size	A		D		EØ	
					mm	in	mm	in	mm	in	mm
1W12MP12		-12	19	-12	92,1	3,63	40,1	1,58	15,1	0,59	30
1W16MP16		-16	25	-16	114,5	4,51	47,9	1,88	19,6	0,77	36

* Requires separate installation of 2 ea. p/n 05.071-27.30x2.40 O-rings (must be ordered separately). O-rings must be installed with PAG oil (only) prior to crimping.

Spiral – 1W series

1W sockets

Sockets for 1W fittings

Part ① 1W part #	Hose size info		Dimensions			
	DN	Hose size	L		OD	
			mm	in	mm	in
1WA12	20	-12	52,1	2.05	43,1	1.70
1WA16	25	-16	66,5	2.62	48,8	1.92
1WA20	31	-20	77,7	3.06	57,2	2.25
1WB24	38	-24	96,6	3.80	70,6	2.78
1WB32	51	-32	107,1	4.22	87,6	3.45
1WD12	20	-12	57,0	2.24	42,1	1.66
1WD16	25	-16	67,5	2.66	51,4	2.02
1WE20	31	-20	78,7	3.10	63,5	2.50

Socket type by hose

Part ① Hose part #	Dimensions Socket
EC600-12	1WD12
EC600-16	1WD16
EC600-20	1WE20
EC600-24	1WB24
EC600-32	1WB32
EC850-10	1WD10
EC850-12	1WD12
EC850-16	1WD16
EC850-20	1WE20
EC910-12	1WA12
EC910-16	1WA16
GH466-20	1WB20
GH466-24	1WB24
GH466-32	1WB32
GH506-12	1WA12
GH506-16	1WA16
GH506-20	1WA20
GH506-24	1WA24
GH506-32	1WA32

* Requires separate installation of 2 ea. p/n 05.071-27.30x2.40 O-rings (must be ordered separately). O-rings must be installed with PAG oil (only) prior to crimping.

Aeroquip by Danfoss

Flange | Flange kit | O-rings



Split flange

Split flanges

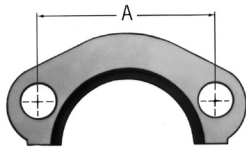
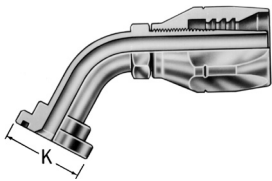

Danfoss has standard pressure series (code 61) and high pressure series (code 62) split flange components in kit form that save time in selecting and ordering. Each kit includes two flange halves, four grade-8 hex bolts, four lock washers and an O-Ring. The standard kit has a Buna-N 90 durometer O-Ring that is compatible with petroleum and water-base hydraulic fluids. Optional kits contain EPDM and Viton* O-Ring for applications where fluid compatibility or high temperatures require other than Buna-N O-Ring.

*Viton is a trademark of The Chemours Company FC, LLC

Two methods can be used to determine the flange dash size and code. The first is by measuring the flange head diameter on the fitting itself. This is referred to as the “K” dimension. The second is by measuring the “A” dimension on the flange or the flange port. Either will determine the dash size and the code since these dimensions are exclusive to either code 61 or code 62 split flange kits. See chart below for these dimensions. In some cases, split flange fittings are available for hoses which exceed the pressures listed; when ordering fittings or hose assemblies, the terminal end performance rating may reduce the overall rating of the assembly.

Split flange					
“A” Dim.	“K” Flange head diameter	Flange dash size	Maximum operating pressure*		Recommended bolt torque
			bar	psi	
Code 61					
1.50	1.19	-08	350,0	5000	175–225
1.88	1.50	-12	350,0	5000	225–350
2.06	1.75	-16	350,0	5000	325–425
2.31	2.00	-20	280,0	4000	425–550
2.75	2.38	-24	210,0	3000	550–700
3.06	2.81	-32	210,0	3000	650–800
3.50	3.31	-40	175,0	2500	950–1100
4.19	4.00	-48	140,0	2000	1650–1800
Code 62					
1.59	1.25	-08	420,0	6000	175–225
2.00	1.63	-12	420,0	6000	300–400
2.25	1.88	-16	420,0	6000	500–600
2.62	2.12	-20	420,0	6000	750–900
3.12	2.50	-24	420,0	6000	1400–1600
3.81	3.12	-32	420,0	6000	2400–2600

*Per SAE J518 standard.

Many leakage problems can be avoided if the split flanges are properly assembled.

1. Clean all mating surfaces.
 2. Lubricate the O-Ring.
 3. Partially tighten each bolt in rotation until all are fully tightened to the recommended torque value.
1. Determine the dash size and the code.
 2. Select O-Ring for fluid compatibility.
 3. Order by kit number shown on pages 245-247.

Split flange kits

SAE standard pressure series
(Code 61) SAE J518

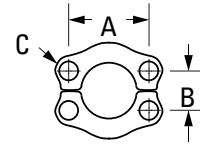
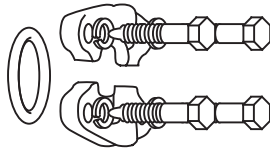

O-Rings material: Buna-N 90 Durometer
Temperature range: -40°F to +250°F (-40°C to + 121°C)

Split flange SAE standard pressure series

Nominal Flange Size	Complete Kit	*Flange halves 2 required	*Buna-N O-Ring 1 required	*Bolts 4 required	*Lock washer 4 required	A	B	C	Bolt torque lb.-in
1/2	FF593-08	449-74446-8	FF9446-210	FF9442-0520-94	210104-5S	1.50	0.68	0.34	175-225
3/4	FF593-12	449-74446-12	FF9446-214	FF9442-0620-94	210104-6S	1.88	0.88	0.41	250-350
1	FF593-16	449-74446-16	FF9446-219	FF9442-0620-94	210104-2-6S	2.06	1.04	0.41	325-425
1-1/4	FF593-20	449-74446-20	FF9446-222	FF9442-0724-94	210104-7S	2.31	1.18	0.48	425-550
1-1/2	FF593-24	449-74446-24	FF9446-225	FF9442-0824-94	210104-8S	2.75	1.40	0.53	550-700
2	FF593-32	449-74446-32	FF9446-228	FF9442-0824-94	210104-8S	3.06	1.68	0.53	650-800
2-1/2	FF593-40	449-74446-40	FF9446-232	FF9442-0828-94	210104-8S	3.50	2.00	0.53	950-1100
3	FF593-48	449-74446-48	FF9446-237	FF9442-1028-94	210104-10S	4.19	2.44	0.66	1650-1800

* Included in kit.

*Viton kit available as part # FF687-Size. EPDM kit available as part # FF688-size. See pg. 244 for Viton and EPDM O-Ring part numbers.

Note: All measurements in inches.

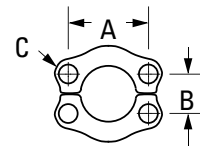
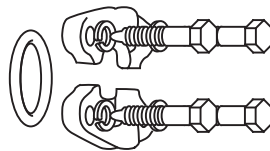

SAE high pressure series
(Code 62) SAE J518

O-Ring material: Buna-N 90 Durometer
Temperature range: -40°F to +250°F (-40°C to + 121°C)

Split flange SAE high pressure series

Nominal Flange Size	Complete Kit	*Flange halves 2 required	*Buna-N O-Ring 1 required	*Bolts 4 required	*Lock washer 4 required	A	B	C	Bolt torque lb.-in
3/4	FF595-12	FC3425-12-449	FF9446-214	FF9442-0624-94	210104-6S	2.00	0.94	0.42	300-400
1	FF595-16	FC3425-16-449	FF9446-219	FF9442-0728-94	210104-7S	2.25	1.10	0.50	500-600
1-1/4	FF595-20	FC3425-20-449	FF9446-222	FF9442-0828-94	210104-8S	2.62	1.24	0.60	750-900
1-1/2	FF595-24	FC3425-24-449	FF9446-225	FF9442-1036-94	210104-10S	3.12	1.44	0.66	1400-1600
2	FF595-32	FC3425-32-449	FF9446-228	FF9442-1244-94	210104-12S	3.81	1.76	0.78	2400-2600

* Included in kit.

* Viton kit available as part #FF689-size. See page 244 for Viton O-Ring part numbers.

Note: All measurements in inches.

Note: Code 62 split flange kits cannot be used with Cat flange fittings. Use existing split flanges.

Split flange kits

Split flange kits

4 hole flange
SAE standard pressure series
(Code 61) SAE J518

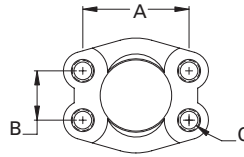

4-hole flange SAE standard pressure

Nominal Flange Size	4 bolt flange	A	B	C (Threaded)
3/4	FC2119-12-449	1.88	0.88	3/8-16
1	FC2119-16-449	2.06	1.03	7/16-14
1-1/4	FC2119-20-449	2.31	1.19	3/8-16
1-1/2	FC2119-24-449	2.75	1.41	1/2-13
2	FC2119-32-449	3.06	1.69	1/2-13
2-1/2	FC2119-40-449	3.50	2.00	1/2-13

*Available without threads as part #FC3459-size-449.

NOTE: All measurements in inches.

O-Ring for SAE J518
Split flange

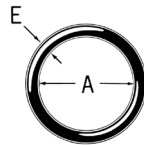

O-Ring for split flange

O-Ring base #	Material	Operating temperature range
FF9016 EPDM	80 Durometer	-65°F to +300°F (-55°C to +150°C)
FF9446 Buna-N	90 Durometer Buna-N	-40°F to +250°F (-40°C to +121°C)
22046 Viton	90 Durometer	-15°F to +400°F (-25°C to +205°C)

Available without threads part #FC3459-size-449.

O-Ring for split flange

O-Ring dash size designation	Flange Dash Size	Nominal flange Size	A		E	
			mm	in	mm	in
-210	08	1/2	18,5	0.734	3,5	0.139
-214	12	3/4	24,9	0.984	3,5	0.139
-219	16	1	32,9	1.296	3,5	0.139
-222	20	1 1/4	37,7	1.484	3,5	0.139
-225	24	1 1/2	47,2	1.859	3,5	0.139
-228	32	2	56,7	2.234	3,5	0.139
-232	40	2 1/2	69,4	2.734	3,5	0.139
-237	48	3	85,3	3.359	3,5	0.139

O-Rings

Cat flange D-Ring*

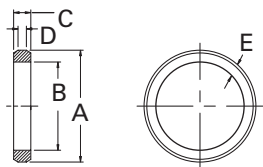

Cat flange D-Ring*

Part #	A		B		C		D		E	
	mm	in	mm	in	mm	in	mm	in	mm	in
FF90319-12	32,3	1.27	25,4	1.00	5,1	0.20	2,5	0.10	3,6	0.14
FF90319-16	38,6	1.52	31,8	1.25	5,1	0.20	2,5	0.10	3,6	0.14
FF90319-20	45,0	1.77	38,1	1.50	5,1	0.20	2,5	0.10	3,6	0.14
FF90319-24	51,6	2.03	44,7	1.76	5,1	0.20	2,5	0.10	3,6	0.14
FF90319-32	70,6	2.78	64,0	2.52	5,1	0.20	2,5	0.10	3,6	0.14

Temperature range: -40°F to +212°F

Material: Nitrile (Buna-N).

*To be used only with Cat flange.

O-Rings for bump tube O-Ring seal and O-Ring pilot fitting

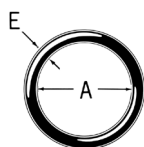

O-Rings for bump tube O-Ring seal and O-Ring pilot fitting

Part #	O-Ring pilot dash size	A		E	
		mm	in	mm	in
FF90319-12	-06	7,6	0.30	1,8	0.07
FF90319-16	-08	10,9	0.43	1,8	0.07
FF90319-20	-10	14,0	0.55	1,8	0.07
FF90319-24	-12	17,3	0.68	1,8	0.07

O-Rings & Kits

O-Rings

O-Ring seal kit
FF16087-01

Includes: metal box,
O-Rings for ORS -4 through -24,
O-Ring boss -04 through -32,
Split flange -08 through -32,
24 packages with twelve
90 durometer nitrile
O-Ring per package.
Replacement O-Ring can be ordered
individually by part number listed.



FF16087-01

BSPP bonded seal
for DIN 3852-2 ports
FF9895

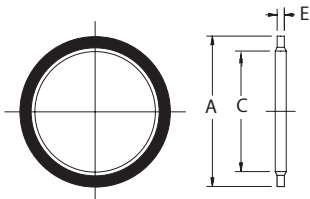

O-Ring seal kit		
Connection	Size	Individual O-Ring part #
ORS	-04	FF9446-11
ORS	-06	FF9446-12
ORS	-08	FF9446-14
ORS	-10	FF9446-16
ORS	-12	FF9446-18
ORS	-16	FF9446-21
ORS	-20	FF9446-25
ORS	-24	FF9446-29
O-Ring Boss	-04	22617-4
O-Ring Boss	-05	22617-5
O-Ring Boss	-06	22617-6
O-Ring Boss	-08	22617-8
O-Ring Boss	-10	22617-10
O-Ring Boss	-12	22617-12
O-Ring Boss	-16	22617-16
O-Ring Boss	-20	22617-20
O-Ring Boss	-24	22617-24
O-Ring Boss	-32	22617-32
Split Flange	-08	FF9446-210
Split Flange	-12	FF9446-214
Split Flange	-16	FF9446-219
Split Flange	-20	FF9446-222
Split Flange	-24	FF9446-225
Split Flange	-32	FF9446-228

O-Ring for split flange				
Bonded Seal Part #	BSPP Thread Size	A Ref	B Ref	C ref
	inch	inch	inch	inch
FF9895-02	1/8-28	0.625	0.403	0.080
FF9895-04	1/4-19	0.810	0.536	0.080
FF9895-06	3/8-19	0.937	0.675	0.080
FF9895-08	1/2-14	1.125	0.843	0.097
FF9895-10	5/8-14	1.250	0.920	0.097
FF9895-12	3/4-14	1.375	1.060	0.097
FF9895-16	1-11	1.685	1.329	0.133
FF9895-20	1 1/4-11	2.062	1.685	0.133
FF9895-24	1 1/2-11	2.307	1.902	0.133
FF9895-32	2-11	2.875	2.380	0.133

Material: steel with bonded nitrile (buna-n) seal.

O-Rings & kits

Designating separate SAE O-Ring boss

To order Danfoss O-Ring separately without fittings specify the size and material by using the O-Ring base number and dash size.

The charts offer a simple method to assure the correct O-Ring for your application.

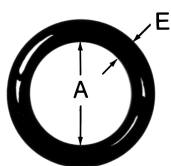

SAE O-Rings		
O-Ring Base #	Material	Operating temperature range
22617 (Standard)	Buna-N Nitrile rubber 90 Durometer	-30° F to +250° F (-34° C to + 121° C)
22033	EPDM Ethylene propylene diene monomer	-65° F to +212° F (-55° C to + 100° C)
22068	Viton Fluoroelastomer 90 Durometer	-15° F to +400° F (-24° C to + 205° C)
22012	Buna-N, Low temperature nitrile rubber 90 Durometer	-65° F to +225° F (-55° C to + 107° C)

SAE O-Ring size					
O-Ring dash size	Tube size	A		E	
		mm	in	mm	in
-4	-04 (1/4)	8,9	0.351	1,8	0.072
-6	-06 (3/8)	11,9	0.468	2,0	0.078
-8	-08 (1/2)	16,3	0.644	2,3	0.087
-10	-10 (5/8)	19,3	0.755	2,5	0.097
-12	-12 (3/4)	23,4	0.924	3,0	0.116
-16	-16 (1)	29,7	1.171	3,0	0.116
-20	-20 (1 1/4)	37,6	1.475	3,0	0.118
-24	-24 (1 1/2)	43,7	1.720	3,0	0.118

Split flange kit

O-Rings & kits

Designating separate ORS O-Ring boss

To order Danfoss O-Ring separately without fittings specify the size and material by using the O-Ring base number and dash size. The charts offer a simple method to assure the correct O-Ring for your application.

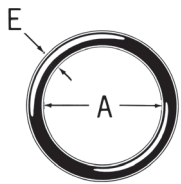

ORS O-Rings		
O-Ring Base #	Material	Operating temperature range
FF9446 (Standard)	Buna-N Nitrile Rubber 90 Durometer	-40°F to +250°F (-40°C to +121°C)
FF9807	EPDM Ethylene propylene diene monomer	-65°F to +300°F (-55°C to +150°C)
22046	Viton Fluoroelastomer 90 Durometer	-15°F to +400°F (-25°C to +205°C)
FF9855	Buna-N, Low Temperature Nitrile Rubber 90 Durometer	-65°F to +225°F (-55°C to +107°C)
22546	Neoprene 90 Durometer	-65°F to +300°F (-55°C to +150°C)

ORS O-Ring size					
O-Ring dash size	Tube size	A		E	
		mm	in	mm	in
-11	-04	7,6	0.301	1,8	0.07
-12	-06	9,2	0.364	1,8	0.07
-14	-08	12,4	0.489	1,8	0.07
-16	-10	15,6	0.614	1,8	0.07
-18	-12	18,8	0.739	1,8	0.07
-21	-16	23,5	0.926	1,8	0.07
-25	-20	29,9	1.176	1,8	0.07
-29	-24	37,8	1.489	1,8	0.07

Aeroquip by Danfoss

Hose accessories



Hose accessories

900564

Steel protective coil spring

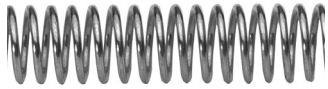

Protects hose cover and reinforcement from abrasion and accidental damage.

Construction: steel wire, rust resistant. This coil should fit snugly to the hose O.D. expanding the coil I.D. (unwind the coil) may be necessary for proper installation.

see Accessories to hose chart pg 258 - 267

900564		
Sleeve dash #	Sleeve I.D.	
	mm	in.
-1S	15,5	0.61
-12S	16,8	0.66
-2S	19,0	0.75
-15S	20,6	0.81
-14S	21,3	0.84
-3S	23,1	0.91
-4S	26,4	1.04
-5S	30,0	1.18
-6S	34,0	1.34
-7S	42,2	1.64
-9S	47,8	1.88
-8S	54,1	2.13
-10S	60,4	2.38
-13S	69,8	2.75
-11S	73,1	2.88

900705

Steel protective coil sleeve



Recommended for use where hose lines are subjected to excessive abrasion, kinking or accidental damage.

Construction: spring steel, rust resistant. This coil should fit snugly to the hose O.D. expanding the coil I.D. (unwind the coil) may be necessary for proper installation.

see Accessories to hose chart pg 258 - 267

900705		
Sleeve dash #	Sleeve I.D.	
	mm	in.
-17S	11,2	0.44
-1S	12,7	0.50
-13S	14,5	0.57
-2S	16,0	0.63
-3S	19,0	0.75
-4S	22,3	0.88
-5S	26,2	1.03
-14S	28,2	1.11
-6S	31,0	1.22
-7S	37,3	1.47
-9S	42,9	1.69
-8S	48,5	1.91
-10S	54,1	2.13
-11S	65,0	2.56

900952

Plastic protective coil spring

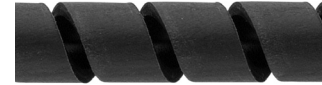

Recommended to protect hose from abrasion, this light weight plastic sleeve is unaffected by air, water, oil, gasoline, hydraulic and most other fluids. This coil can also be used for group bundling of hose lines. Temperature range of 0°F to +180°F.

see Accessories to hose chart pg 258 - 267

900952		
Sleeve dash #	Sleeve I.D.	
	mm	in.
900952-4	6,0	0.24
900952-6	9,5	0.37
900952-8	12,5	0.49
900952-10	16,0	0.63
900952-12	21,0	0.83
900952-16	27,0	1.06
900952-22	34,0	1.34
900952-30	40,0	1.58
900952-40	32,0	1.26
900952-48	79,0	3.11

222005*, 222022

Stainless steel internal support coils



Recommended for vacuum service with most hose.

see Accessories to hose chart pg 258 - 267

222005, 222022		
Part # O.D.	Coil	
	mm	in.
222005-23C	8,6	0.34
222005-10C	10,7	0.42
222005-21C	12,9	0.51
222005-11C	15,2	0.60
222022-12C	17,8	0.70
222005-13C	18,5	0.73
222005-14C	23,9	0.94
222022-16C	24,6	0.97
222005-15C	30,2	1.19
222022-20C	31,7	1.25
222005-17C	36,6	1.44
222022-24C	38,1	1.50
222005-18C	47,7	1.88
222022-32C	50,0	1.97
222005-19C	62,0	2.44
222022-40C	67,8	2.67

*222005 is 301 stainless steel.



FF9217

Band style clamp

Recommended for attaching sleeve to hose lines.

Clamp numbers:
FF9217- 0622S, FF9217-0648S; 3/8 inch wide
FF9217-0664C; 1/2 inch wide.

see Accessories to hose chart pg 258 - 267

FC425

Nylon abrasion sleeve
Meets MSHA requirements

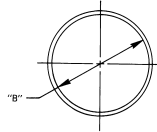

Nylon sleeve protects hose from abrasion and allows bundling of hose lines.

see Accessories to hose chart pg 258 - 267

FC425		
Part #	Nominal Sleeve I.D.* "B"	
	mm	in.
FC425-12	18,0	0.71
FC425-15	23,4	0.92
FC425-16	25,4	1.00
FC425-18	28,7	1.13
FC425-20	31,7	1.25
FC425-24	40,4	1.59
FC425-28	44,4	1.75
FC425-32	52,6	2.07
FC425-38	60,4	2.38
FC425-40	64,5	2.54
FC425-46	72,6	2.86
FC425-54	84,8	3.34
FC425-59	93,0	3.66

* The maximum O.D. of hose fittings must be allowed for if fittings are to be covered.



F2636

Band style clamp tool

Installation tool for FF9217 clamps. Recommended for attaching sleeve to hose lines.

624

Firesleeve



Firesleeve will protect hose from direct flame. Firesleeve is constructed of a uniform single layer of braided fiberglass tubing impregnated with flame resistant silicone rubber. Temperature range of -65°F to +500°F.

see Accessories to hose chart pg 258 - 267

624			
Part #	I.D.		Clamp # (2 required)
	mm	in.	
624-5	7,9	0.31	FF9217-0622S
624-7	11,2	0.44	FF9217-0622S
624-8	12,7	0.50	FF9217-0622S
624-9	14,2	0.56	FF9217-0622S
624-10	15,7	0.62	FF9217-0622S
624-11	17,5	0.69	FF9217-0622S
624-12	19,0	0.75	FF9217-0622S
624-13	20,6	0.81	FF9217-0622S
624-14	22,3	0.88	FF9217-0622S
624-16	25,4	1.00	FF9217-0622S
624-18	28,4	1.12	FF9217-0622S
624-20	31,7	1.25	FF9217-0648S
624-22	35,0	1.38	FF9217-0648S
624-24	38,1	1.50	FF9217-0648S
624-26	41,1	1.62	FF9217-0648S
624-28	44,4	1.75	FF9217-0648S
624-30	47,7	1.88	FF9217-0648S
624-32	50,8	2.00	FF9217-0648S
624-38	60,4	2.38	FF9217-0648S
624-42	66,5	2.62	FF9217-0648S
624-46	73,1	2.88	FF9217-0664C
624-50	79,2	3.12	FF9217-0664C
624-54	85,8	3.38	FF9217-0664C
624-60	95,2	3.75	FF9217-0664C

Hose accessories

FF90754

Guardian sleeve



Danfoss' new Guardian Sleeve is designed to provide protection against hydraulic hose failure by containing pressure and fluids that may escape during a hose burst or pinhole leak.

see Accessories to hose chart pg 258 - 267

FF90754		
Properties	Specification	Description
Burst pressure	16,000 psi	Capable to contain hose burst up to 16,000 psi
Pin hole leak pressure	4,000 psi	Sustained 4,000 psi pin hole deflection from focused 1mm pin hole
Abrasion cycles	250,000	Holds up to 250,000 abrasion cycles per ISO 6945

General and dimensional information

Part #	Nominal I.D. (in)	A - Flat width (in) +/- 0.125	Weights in lbs per 300 ft Roll	Rolls per box
FF90754-68	0.68	1.290	7.43	8
FF90754-79	0.79	1.400	8.50	7
FF90754-91	0.91	1.590	9.70	6
FF90754-98	0.98	1.590	10.13	6
FF90754-106	1.06	1.825	11.10	5
FF90754-122	1.22	2.076	12.60	4
FF90754-142	1.42	2.390	14.50	4
FF90754-157	1.57	2.650	16.10	3
FF90754-173	1.73	2.910	17.70	3
FF90754-185	1.85	3.100	18.80	3
FF90754-209	2.09	3.470	21.10	2
FF90754-219	2.19	3.630	22.10	2
FF90754-238	2.38	3.925	23.90	2
FF90754-288	2.88	4.714	28.60	2
FF90754-366	3.66	5.938	36.10	1

Guardian sleeve selection chart

Suggested sleeve part #	Sleeve I.D. (in)	Max hose OD that sleeve can accept (in)	Hose size as a ref.
FF90754-68	0.68	0.52	-4
FF90754-79	0.79	0.61	-4
FF90754-91	0.91	0.70	-6
FF90754-98	0.98	0.76	-6
FF90754-106	1.06	0.80	-6
FF90754-122	1.22	0.92	-8
FF90754-142	1.42	1.02	-10
FF90754-157	1.57	1.13	-10
FF90754-173	1.73	1.24	-12
FF90754-185	1.85	1.34	-16
FF90754-209	2.09	1.50	-16
FF90754-219	2.19	1.54	-20
FF90754-238	2.38	1.70	-20
FF90754-288	2.88	2.00	-20
FF90754-366	3.66	2.40	-24

Denier: 1260

Melting Point: 215°C/420°F

Material: Polyamide 6, made with pre-dyed yarn

Dim. Stability: Great resistance to sun, atmospheric agents and aging

Toxicity: Non-Toxic

Color: Black

Packing Requirements: Danfoss Guardian Sleeve comes in a 300 foot roll with no more than 3 cuts per roll and no piece shorter than 30 feet.

Note: must be ordered by the roll.

Guardian sleeve chemical compatibility

Chemical	Compatibility
Gasoline	Very Good
Oil	Very Good
Mineral and vegetable oil	Very Good
Ionic metallic solutions	Very Good
Alcohols	Very Good
Diluted bases	Very Good
Diluted acids *	Good
Benzene	Very Good
Acetone	Very Good
Ether	Very Good
Carbon Tetrachloride	Very Good
Chlorine based solvent	Very Good
Mold, bacteria, moths	Very Good

*Strong and concentrated acids; ie. Hcl or Formic acid may have some corrosive action.

Select the correct sleeve part number for the hose.

Cut the sleeve 2 inches longer than the cut length of the hose to allow full hose bend radius.

The ends of the sleeves must be seared to prevent sleeve from fraying.

Slide the sleeve over the hose.

Properly assemble the hose ends.

Secure the sleeve over hose sockets with a metal banding product.

900729 Support clamp



These lightweight vinyl-coated steel support clamps are designed to support hose where long runs are necessary. This clamp not only furnishes a cleaner installation, but prevents damage, exposure and chafing. The lining will withstand high ambient temperatures.

Clamp dash no. -01 thru -8, -18 thru -23 is .406; -9 thru -17, -24 thru -31 is .531.

see Accessories to hose chart pg 258 - 267

900729		
Clamp dash #	Clamp I.D. Closed	
	mm	in.
-18	6,3	0.25
-19	9,6	0.38
-01	11,2	0.44
-1	12,7	0.50
-2	14,2	0.56
-21	16,0	0.63
-3	17,5	0.69
-4	19,0	0.75
-5	20,6	0.81
-6	23,9	0.94
-23	25,4	1.00
-8	26,9	1.06
-9	28,7	1.13
-27	30,2	1.19
-24	31,7	1.25
-25	33,3	1.31
-10	38,1	1.50
-11	39,6	1.56
-12	44,4	1.75
-28	46,0	1.81
-13	50,8	2.00
-29	52,3	2.06
-14	57,1	2.25
-30	63,5	2.50
-31	66,8	2.63
-15	69,8	2.75
-16	73,1	2.88
-17	90,4	3.56

FF90311 Heavy duty hose support clamps

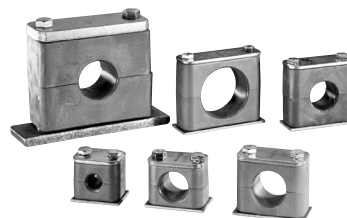

These heavy duty weld-based clamps are designed to securely hold hose in applications subject to impulsing, flexing and vibrating conditions. The clamps help prevent abrasion and extend hose life through proper routing. Clamps are rated to ambient temperature of +250°F.

see Accessories to hose chart pg 258 - 267

FF90311		
Clamp Part #	Inside diameter	
	mm	in.
FF90311-127	12,7	0.50
FF90311-137	13,7	0.54
FF90311-150	15,0	0.59
FF90311-160	16,0	0.63
FF90311-171	17,1	0.67
FF90311-174	17,4	0.69
FF90311-190	19,0	0.75
FF90311-205	20,5	0.81
FF90311-222	22,2	0.87
FF90311-239	23,9	0.94
FF90311-254	25,4	1.00
FF90311-266	26,6	1.05
FF90311-280	28,0	1.10
FF90311-300	30,0	1.18
FF90311-320	32,0	1.26
FF90311-334	33,4	1.31
FF90311-357	35,7	1.41
FF90311-381	38,1	1.50
FF90311-400	40,0	1.57
FF90311-422	42,2	1.66
FF90311-445	44,5	1.75
FF90311-483	48,3	1.90
FF90311-508	50,8	2.00
FF90311-572	57,2	2.25
FF90311-635	63,5	2.50
FF90311-700	70,0	2.76

Hose accessories

Round-wire clamps

Carbon steel spring wire, Zinc plated.

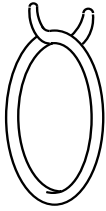

- Industrial
- Automotive
- Agriculture
- General market applications

Round-wire clamps					
Clamp size	Hose size	Part #	Minimum diameter	Maximum diameter	Nominal diameter
06	1/4	1538	.370	.380	.375
08	5/16	1539	.551	.573	.562
10	3/8	1540	.610	.640	.625

6207 E.F.I. hose clamps

Electronic fuel injection hose clamps

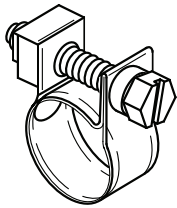

Plated carbon steel
23/64" (9 mm) band width

6207 - E.F.I. hose clamps				
Clamp size	Part #	Minimum diameter	Maximum diameter	Nominal diameter
04	6207-004	.433	.551	.512
05	6207-005	.472	.590	.551
06	6207-006	.551	.669	.630

Partial stainless steel clamps

Full-sized and micro-sized clamps

SAE J1508 Type F

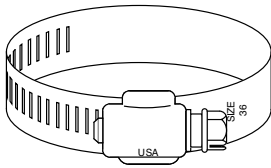

Partial stainless steel clamps utilize a 300 Series stainless steel band and housing with a steel case-hardened, zinc-plated screw. They feature a 14.3mm (9/16") band housing with a 8mm (5/16") hexagon and screwdriver slotted screw.

- Heavy-duty equipment
- Agriculture
- General industry

6205/6203 - Partial stainless steel clamps				
Clamp size	Part #	Minimum diameter	Maximum diameter	Nominal diameter
*004	6205-004	7/32	5/8	1/4
*006	6205-006	5/16	7/8	1/2
006	6203-006	3/8	7/8	1/2
008	6203-008	7/16	1	9/16
010	6203-010	9/16	1-1/16	5/8
012	6203-012	9/16	1-1/4	3/4
016	6203-016	11/16	1-1/2	1
020	6203-020	3/4	1-3/4	1-1/4
024	6203-024	1-1/16	2	1-1/2
028	6203-028	1-5/16	2-1/4	1-3/4
032	6203-032	1-9/16	2-1/2	2
036	6203-036	1-13/16	2-3/4	2-1/4
040	6203-040	2-1/16	3	2-1/2
044	6203-044	2-5/16	3-1/4	2-3/4
048	6203-048	2-9/16	3-1/2	3
052	6203-052	2-13/16	3-3/4	3-1/4
056	6203-056	3-1/16	4	3-1/2
064	6203-064	3-9/16	4-1/2	4
072	6203-072	4-1/16	5	4-1/2
080	6203-080	4-5/8	5-1/2	5
088	6203-088	4-3/32	6	5-1/2
096	6203-096	4-1/2	6-1/2	6
104	6203-104	5	7	6-1/2

*Micro-sized clamps

All stainless steel clamps

Full-sized and micro-sized clamps

SAE J1508 Type F

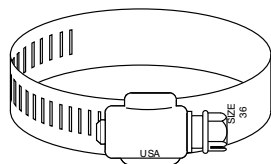

Clamps with an all stainless steel construction offers maximum protection against corrosion.

Full-sized all stainless clamps have a 14.3mm (9/16") band and housing manufactured with 300 Series stainless steel. The 8mm (5/16") hexagon and screwdriver slotted screw features 410 stainless steel.

Micro-sized all stainless clamps have a 5/16" (8mm) band and housing manufactured with 300 Series stainless steel. The 6.35mm (1/4") hexagon and screwdriver slotted screw features 410 stainless steel.

- Chemical
- Marine
- Food processing
- Dairy
- Automotive
- Electrical
- Plumbing

All stainless steel clamps

Clamp size	Part #	Minimum diameter	Maximum diameter	Nominal diameter
*004	6206-004	7/32	5/8	1/4
*006	6206-006	5/16	7/8	1/2
006	6204-006	3/8	7/8	1/2
008	6204-008	7/16	1	9/16
010	6204-010	9/16	1-1/16	5/8
012	6204-012	9/16	1-1/4	3/4
016	6204-016	11/16	1-1/2	1
020	6204-020	3/4	1-3/4	1-1/4
024	6204-024	1-1/16	2	1-1/2
028	6204-028	1-5/16	2-1/4	1-3/4
032	6204-032	1-9/16	2-1/2	2
036	6204-036	1-13/16	2-3/4	2-1/4
040	6204-040	2-1/16	3	2-1/2
044	6204-044	2-5/16	3-1/4	2-3/4
048	6204-048	2-9/16	3-1/2	3
052	6204-052	2-13/16	3-3/4	3-1/4
056	6204-056	3-1/16	4	3-1/2
064	6204-064	3-9/16	4-1/2	4
072	6204-072	4-1/16	5	4-1/2
080	6204-080	4-5/8	5-1/2	5
088	6204-088	4-3/32	6	5-1/2
096	6204-096	4-1/2	6-1/2	6
104	6204-104	5	7	6-1/2

*Micro-sized clamps

A5950

Hose bend restrictors



For use in protecting the last section of hose at the fitting connection, bend restrictors are designed to allow for an appropriate degree of "bend" without compromising the integrity of hose assemblies. They are also recommended for hose assemblies that receive substantial handling, such as in pressure washer, air, oil, and hydraulic fluid transfer applications.

Plastisol MR 436 gloss PVC

see Accessories to hose chart pg 258 - 267

A5950 hose bend restrictors

Restrictor I.D. (in.)	Part #	Restrictor length (in.)
0.530	A5953	6
0.625	A5962	6
0.690	A5969	6
0.750	A5975	7
0.840	A5984	7
0.875	A5987	7

Hose accessories

HP Series

Hose protectors



Easy installation in minutes – no need to remove hose, formulated to resist solvents, oils, grease and gasoline.

Hose protectors

Part #	Description	Color
HP4-B	4" Hose protector case of 50	Black
HP4-O	4" Hose protector case of 50	Orange
HP6-B	6" Hose protector case of 50	Black
HP6-O	6" Hose protector case of 50	Orange
HP8-B	8" Hose protector case of 50	Black
HP8-O	8" Hose protector case of 50	Orange
HP10-B	10" Hose protector case of 10	Black
HP10-O	10" Hose protector case of 10	Orange
HP12-B	12" Hose protector case of 10	Black
HP12-O	12" Hose protector case of 10	Orange
HPMB-60*	Mixed hose protectors case of 60	Black
HPMO-60*	Mixed hose protectors case of 60	Orange

*The HPM multi-pack contain 60 pieces, 20 of each size, -4, -6, and -8

- Operating temperature range is -40° to 430°F
- Exceptionally cost effective
- Packed in easy to assemble, colorful, counter display box
- Available in 5 sizes: -4, -6 -8 -10 & -12; cable ties included
- Farming
- Industrial
- Trucking
- Mining
- Construction
- Aviation support
- Road maintenance
- Waste management
- Original equip. manuf.

HLM-48

Hose looms



Hose looms

Part #	Description
HLM-48	Case of 48 mixed hose looms

- Prevents hose abrasion at points of contact
- Keeps multiple hoses organized
- Simplifies hose routing
- Prevents damage from unrestrained hoses
- Available in 4 sizes – 3/4", 1", 1-1/8", 1-3/8"
- Packed in colorful counter display boxes of 48
- Also available in mixed boxes of 48 (12 each size) or refill bags of 12

HSM-48

Hose spacers



Hose spacers

Part #	Description
HSM-48	Case of 48 mixed Hose Spacers

- Prevents hose abrasion at points of contact
- Helps keep hoses organized
- Prevents damage from unrestrained hoses
- Available in 4 sizes – 3/4", 1", 1-1/8", 1-3/8"
- Packed in colorful counter display boxes of 48 – cable ties included
- Also available in mixed boxes of 48 (12 each size) or refill bags of 12

FF90308

Hose insertion gauge



Improve hose assembly reliability with these easy to use aluminum gages that are designed to ensure proper fitting depth during pre-assembly.

Simply bottom the hose in the appropriately marked cavity and scribe a mark on the hose flush with the top surface of the gauge. Insert the fitting until the back of the socket is aligned with scribe line.

Hose insertion gauge

Part #	Usage
FF90308-01	For use with all hoses that mate with -4 through -16 1A (TTC)/Z series
FF90308-02	For use with all hoses that mate with -20 through -32 1A (TTC)/Z series
FF90308-04	For use with all hoses that mate with -06, -08, -10, -12, -16 spiral 4S/6S fittings
FF90308-05	For use with all hoses that mate with -20, -24, -32 spiral 4S/6S fittings

Flaretite seals



The ideal product to enhance new installations of SAE 37° connections, as well as seal off minor leaks and weeping connections.

- Ribbed insert design
- Coated with Loctite sealant
- Economical method to reduce minor leaks and weeping connections
- Built-in clip to attach the Flaretite seal to the nose of the SAE 37 degree connection
- Available sizes: -04 through -32
- Multiple surface contact points
- Locks the joint and fills surface imperfections
- Saves time & money associated with maintenance and rework
- Quick & easy assembly

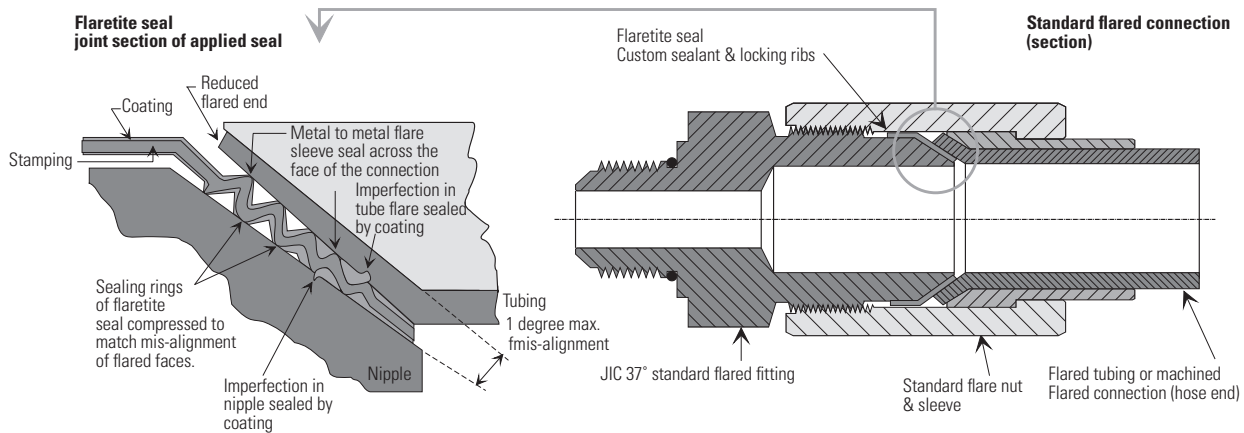

Flaretite seals		
Seal size	Package part #	Number of seals per package
-04	FF13267	100
-06	FF13268	100
-08	FF13269	100
-10	FF13270	100
-12	FF13271	100
-16	FF13272	50
-20	FF13273	50
-24	FF13570	25
-32	FF13571	10

To assemble an SAE 37° connection using a Flaretite seal, simply push the Flaretite seal onto the male portion of the connection. The built-in clip will hold the Flaretite seal onto the male half.

During assembly ensure:

- The seal is fitted squarely to the conical nose of the JIC fitting -37° flare.
- The sealing faces of the flared connector part are clean and free of burrs.
- The flared joint is correctly tightened with recommended torque settings noted below.











Recommended torque settings:

Tolerance: +10% -0%

-04 (1/4")	SAE 37°: 14lb-ft.	-10 (5/8")	SAE 37°: 80lb-ft.	-20 (1-1/4")	SAE 37°: 190lb-ft.
-06 (3/8")	SAE 37°: 26lb-ft.	-12 (3/4")	SAE 37°: 110lb-ft.	-24 (1-1/2")	SAE 37°: 220lb-ft.
-08 (1/2")	SAE 37°: 55lb-ft.	-16 (1")	SAE 37°: 140lb-ft.	-32 (2")	SAE 37°: 325lb-ft.











* Flaretite is a registered trademark of Flaretite Inc.
 All photos and the name Flaretite are the property of Flaretite Inc.
 ** Loctite is a registered trademark of the Henkel Corporation.

Accessories to hose chart

Hose Part #	900564	900705	900952	222005 222022	900729	FF90311	FC425	624	FF9217	FF90754	A5950
	Steel protective coil spring*	Steel protective coil sleeve*	Plastic coil sleeve*	Internal support coil	Support clamp	Heavy duty support clamp	Nylon sleeve*	Fire-sleeve*	Band style clamp	Guardian sleeve*	Bend restrictor
											
2651-4	-1S	-1S	-6	-	-1	-127	-12	-11	-0622S	-68	A5950
2651-5	-12S	-13S	-8	-	-2	-137	-12	-12	-0622S	-79	A5962
2651-6	-2S	-2S	-10	-	-21	-171	-16	-14	-0622S	-91	A5962
2651-8	-14S	-3S	-12	-10C	-4	-174	-16	-16	-0622S	-106	A5969
2651-10	-4S	-4S	-12	-21C	-5	-222	-20	-18	-0622S	-122	A5984
2651-12	-5S	-5S	-16	-12C	-8	-266	-20	-20	-0648S	-157	-
2651-16	-6S	-6S	-16	-	-27	-300	-24	-24	-0648S	-173	-
2651-20	-7S	-7S	-22	-15C	-10	-381	-28	-30	-0648S	-209	-
2651-24	-9S	-9S	-22	-17C	-12	-445	-32	-32	-0648S	-238	-
2651-32	-10S	-10S	-30	-18C	-29	-508	-38	-42	-0648S	-366	-
2661-12	-7S	-7S	-30	-14C	-25	-334	-24	-24	-0648S	-219	-
2661-16	-7S	-9S	2	-15C	-11	-400	-32	-30	-0648S	-288	-
2661-20	-8S	-10S	-	-20C	-28	-483	-38	-38	-0648S	-366	-
2661-24	-10S	-11S	-	-24C	-29	-508	-40	-42	-0648S	-366	-
2661-32	-11S	2	-	-	-31	-635	-54	-50	-0664C	-	-
2661-40	-	-	-	-40C	-16	-	-59	-60	-0664C	-	-
2661-48	-	-	-	-48C	-17	-	-	-	-	-	-
2807-3	-	-	-	-	-18	-	-	-5	-0622S	-68	A5953
2807-4	-	-	-	-	-18	-	-	-7	-0622S	-68	A5953
2807-5	-	-	-4	-	-19	-	-	-9	-0622S	-68	A5953
2807-6	-	-17S	-6	-23C	-1	-	-	-10	-0622S	-68	A5953
2807-8	-1S	-1S	-8	-10C	-1	-137	-12	-12	-0622S	-79	A5962
2807-10	-2S	-3S	-8	-21C	-21	-160	-16	-14	-0630S	-91	A5969
2807-12	-2S	-3S	-10	-13C	-4	-190	-16	-16	-0630S	-98	A5984
2807-16	-3S	-5S	-12	-14C	-23	-266	-20	-20	-0630S	-157	-
2807-20	-5S	-6S	-16	-15C	-24	-320	-24	-24	-0648S	-185	-
2808-8	-12S	-1S	-6	-10C	-2	-150	-12	-16	-0622S	-79	A5969
2808-10	-2S	-2S	-8	-21C	-3	-174	-16	-18	-0630S	-91	A5975
2808-12	-14S	-3S	-10	-13C	-5	-205	-16	-20	-0630S	-122	A5987
2808-16	-5S	-5S	-16	-14C	-8	-280	-20	-26	-0648S	-157	-
2808-20	-7S	-6S	-16	-15C	-25	-334	-24	-32	-0648S	-209	-
2808-24	-7S	-7S	-22	-17C	-11	-422	-28	-38	-0648S	-238	-
3TR7-02	-	-	-6	-	-18	-	-12	-	-0622S	-68	A5953
3TR7-03	-	-	-8	-	-19	-	-12	-	-0622S	-79	A5953
3TR7-04	-	-	-10	-	-01	-	-12	-	-0622S	-79	A5953
3TR7-05	-	-	-10	-	-2	-137	-16	-	-0622S	-91	A5962
3TR7-06	-	-	-12	-	-21	-160	-16	-	-0622S	-98	A5969
3TR7-08	-	-	-12	-	-5	-205	-16	-	-0622S	-142	A5987
3TR7-10	-	-	-16	-	-5	-222	-18	-	-0622S	-157	-











*Sizes indicated are based on Hose O.D. only. If sleeve is to be placed over fittings, a larger sleeve size may be required, depending on type of fitting used.

Accessories to hose chart

Hose Part #	900564	900705	900952	222005 222022	900729	FF90311	FC425	624	FF9217	FF90754	A5950
	Steel protective coil spring*	Steel protective coil sleeve*	Plastic coil sleeve*	Internal support coil	Support clamp	Heavy duty support clamp	Nylon sleeve*	Fire-sleeve*	Band style clamp	Guardian sleeve*	Bend restrictor
											
3TR7-12	-	-	-16	-	-23	-254	-20	-	-0648S	-173	-
3TR7-16	-	-	-22	-	-25	-334	-24	-	-0648S	-209	-
3TR7N-02	-	-	-6	-	-18	-	-12	-	-0622S	-68	A5953
3TR7N-03	-	-	-8	-	-19	-	-12	-	-0622S	-79	A5953
3TR7N-04	-	-	-10	-	-01	-	-12	-	-0622S	-79	A5953
3TR7N-05	-	-	-10	-	-2	-137	-16	-	-0622S	-91	A5962
3TR7N-06	-	-	-12	-	-21	-160	-16	-	-0622S	-98	A5969
3TR7N-08	-	-	-12	-	-5	-205	-16	-	-0622S	-142	A5987
3TR7N-10	-	-	-16	-	-5	-222	-18	-	-0622S	-157	-
3TR7N-12	-	-	-16	-	-23	-254	-20	-	-0648S	-173	-
3TR7N-16	-	-	-22	-	-25	-334	-24	-	-0648S	-209	-
3TR8-04	-	-	-10	-	-2	-150	-16	-	-0622S	-98	A5969
3TR8-06	-	-	-12	-	-3	-174	-16	-	-0622S	-106	A5984
3TR8-08	-	-	-16	-	-5	-222	-18	-	-0622S	-142	-
3TR8-12	-	-	-22	-	-8	-280	-20	-	-0648S	-173	-
3TR8-16	-	-	-30	-	-25	-357	-24	-	-0648S	-219	-
3TR8N-04	-	-	-10	-	-2	-150	-16	-	-0622S	-98	A5969
3TR8N-06	-	-	-12	-	-3	-174	-16	-	-0622S	-106	A5984
3TR8N-08	-	-	-16	-	-5	-222	-18	-	-0622S	-142	-
3TR8N-12	-	-	-22	-	-8	-280	-20	-	-0648S	-173	-
3TR8N-16	-	-	-30	-	-25	-357	-24	-	-0648S	-219	-
3TR18CT-04	-	-	-8	-	-01	-	-12	-	-0622S	-79	A5953
3TR18CT-05	-	-	-10	-	-2	-137	-16	-	-0622S	-91	A5962
3TR18CT-06	-	-	-12	-	-21	-160	-16	-	-0622S	-98	A5969
3TR18CT-08	-	-	-16	-	-5	-205	-16	-	-0622S	-142	A5987
3TR18CT-10	-	-	-16	-	-23	-266	-20	-	-0648S	-173	-
CR170-06	-2S	-2S	-10	-	-21	-	-16	-14	-0622S	-91	A5975
CR170-08	-14S	-3S	-12	-10C	-4	-	-16	-16	-0622S	-106	A5984
CR170-12	-5S	-14S	-16	-12C	-8	-	-20	-20	-0648S	-157	-
EC115-04	-1S	-1S	-6	-	-1	-127	-15	-11	-0622S	-68	A5962
EC115-06	-1S	-13S	-8	-	-2	-150	-16	-12	-0622S	-79	A5969
EC115-08	-3S	-4S	-12	-10C	-4	-190	-18	-12	-0622S	-98	A5984
EC115-10	-3S	-3S	-12	-21C	-5	-205	-24	-16	-0622S	-122	-
EC115-12	-4S	-5S	-16	-	-6	-239	-24	-20	-0630S	-142	-
EC115-16	-5S	-6S	-16	-13C	-9	-320	-32	-20	-0630S	-173	-
EC115-20	-7S	-7S	-22	-14C	-11	-400	-38	-30	-0648S	-238	-

*Sizes indicated are based on Hose O.D. only. If sleeve is to be placed over fittings, a larger sleeve size may be required, depending on type of fitting used.

Accessories to hose chart

Hose Part #	900564	900705	900952	222005 222022	900729	FF90311	FC425	624	FF9217	FF90754	A5950
	Steel protective coil spring*	Steel protective coil sleeve*	Plastic coil sleeve*	Internal support coil	Support clamp	Heavy duty support clamp	Nylon sleeve*	Fire-sleeve*	Band style clamp	Guardian sleeve*	Bend restrictor
											
EC115-24	-8S	-10S	-30	-17C	-12	-483	-40	-32	-0664C	-288	-
EC115-32	-13S	-12S	-30	-19C	-30	-635	-54	-46	-0664C	-366	-
EC116-04	-1S	-17S	-8	-	-19	-127	-12	-7	-0622S	-68	A5962
EC116-05	-1S	-17S	-8	-	-01	-127	-12	-8	-0622S	-68	A5962
EC116-06	-1S	-13S	-10	-	-2	-150	-12	-10	-0622S	-79	A5975
EC116-08	-12S	-3S	-12	-	-3	-174	-12	-12	-0622S	-91	A5984
EC118-04	-1S	-1S	-10	-	-01	-	-12	-9	-0622S	-79	A5962
EC118-05	-1S	-13S	-10	-23C	-1	-137	-12	-10	-0622S	-91	A5969
EC118-06	-12S	-3S	-12	-10C	-21	-160	-16	-12	-0622S	-98	A5975
EC118-08	-15S	-4S	-12	-21C	-4	-190	-16	-14	-0622S	-122	A5962
EC118-10	-4S	-5S	-16	-12C	-6	-239	-18	-18	-0622S	-157	-
EC118-12	-5S	-6S	-22	-	-9	-280	-24	-22	-0648S	-185	-
EC118-16	-7S	-7S	-30	-	-25	-357	-28	-26	-0648S	-219	-
EC215-04	-1S	-1S	-6	-	-1	-127	-12	-11	-0622S	-68	A5962
EC215-06	-2S	-2S	-10	-	-3	-174	-16	-14	-0622S	-91	A5984
EC215-08	-15S	-3S	-10	-	-5	-205	-16	-16	-0622S	-122	A5987
EC215-10	-4S	-4S	-12	-21C	-6	-239	-20	-18	-0630S	-122	-
EC215-12	-4S	-4S	-12	-	-6	-	-20	-18	-0633S	-157	-
EC215-16	-7S	-6S	-16	-	-25	-357	-24	-24	-0630S	-209	-
EC215-20	-7S	-9S	-22	-	-12	-422	-28	-28	-0648S	-288	-
EC215-24	-8S	-8S	-30	-	-13	-508	-38	-38	-0648S	-288	-
EC215-32	-13S	-12S	-30	-	-30	-635	-46	-46	-0664C	-	-
EC216-04	-1S	-17S	-8	-	-01	-127	-12	-8	-0622S	-68	A5962
EC216-05	-1S	-1S	-10	-	-1	-137	-12	-9	-0622S	-79	A5969
EC216-06	-1S	-2S	-10	-	-2	-160	-12	-11	-0622S	-91	A5984
EC216-08	-2S	-3S	-12	-	-4	-190	-12	-13	-0622S	-98	A5987
EC230-40	-	-	-	-40C	-16	-700	-54	-54	-0664C	-	-
EC415-06	-3S	-3S	-12	-	-5	-	-18	-18	-0622S	-122	-
EC415-08	-4S	-4S	-12	-	-6	-239	-20	-18	-0630S	-122	-
EC415-10	-4S	-4S	-12	-	-6	-	-20	-18	-0633S	-157	-
EC415-12	-6S	-14S	-16	-	-27	-300	-24	-22	-0648S	-173	-
EC415-16	-7S	-7S	-22	-	-10	-381	-28	-30	-0648S	-209	-
EC415-20	-8S	-9S	-22	-	-28	-445	-32	-38	-0648S	-288	-
EC615-20	-8S	-8S	-30	-	-13	-508	-38	-38	-0648S	-288	-
EC615-24	-10S	-10S	-30	-	-14	-572	-38	-38	-0648S	-366	-
EC810-12	-6S	-6S	-16	-	-24	-320	-24	-26	-0648S	-185	-
EC810-16	-7S	-7S	-22	-	-10	-381	-28	-28	-0648S	-209	-











*Sizes indicated are based on Hose O.D. only. If sleeve is to be placed over fittings, a larger sleeve size may be required, depending on type of fitting used.

Accessories to hose chart

Hose Part #	900564	900705	900952	222005 222022	900729	FF90311	FC425	624	FF9217	FF90754	A5950
	Steel protective coil spring*	Steel protective coil sleeve*	Plastic coil sleeve*	Internal support coil	Support clamp	Heavy duty support clamp	Nylon sleeve*	Fire-sleeve*	Band style clamp	Guardian sleeve*	Bend restrictor
EC810-20	-8S	-8S	-30	-	-13	-508	-38	-38	-0648S	-288	-
EC810-24	-10S	-10S	-30	-	-14	-572	-38	-38	-0648S	-366	-
EC810-32	-11S	-11S	-30	-	-15	-700	-54	-46	-0664C	-	-
EC881-4	-1S	-1S	-8	-21C	-01	-	-12	-9	-0622S	-79	A5962
EC881-6	-1S	-2S	-10	-11C	-2	-137	-16	-11	-0622S	-91	A5975
EC881-8	-2S	-3S	-12	-12C	-21	-160	-16	-12	-0622S	-98	A5987
EC881-10	-15S	-4S	-12	-	-4	-190	-16	-14	-0622S	-122	-
EC881-12	-3S	-5S	-16	-14C	-5	-222	-18	-18	-0622S	-142	-
EC881-16	-5S	-6S	-22	-15C	-9	-280	-24	-22	-0648S	-185	-
EC881-20	-9S	-8S	-	-18C	-11	-422	-32	-30	-0648S	-288	-
EC881-24	-8S	-10S	-	-	-13	-508	-38	-38	-0648S	-366	-
EC881-32	-13S	-11S	-	-40C	-30	-635	-46	-46	-0664C	-	-
EC850-10	-5S	-14S	-22	-12C	-8	-266	-20	-20	-0648S	-173	-
EC850-12	-6S	-7S	-22	-14C	-27	-300	-24	-22	-0648S	-209	-
EC850-16	-7S	-9S	-30	-15C	-10	-381	-28	-28	-0648S	-238	-
EC850-20	-8S	-10S	-	-17C	-28	-483	-38	-38	-0648S	-366	-
EC910-8	-4S	-5S	-16	-21C	-6	-239	-20	-20	-0648S	-157	-
EC910-12	-6S	-7S	-22	-14C	-24	-320	-24	-24	-0648S	-209	-
EC910-16	-7S	-9S	-30	-15C	-10	-381	-28	-28	-0648S	-288	-
FC234-05	-1S	-2S	-10	-23C	-2	-137	-16	-11	-0622S	-91	A5962
FC234-06	-2S	-3S	-12	-23C	-21	-171	-16	-12	-0622S	-98	A5975
FC234-08	-15S	-4S	-12	-10C	-4	-190	-16	-14	-0622S	-122	A5984
FC234-10	-4S	-5S	-16	-21C	-23	-239	-16	-13	-0622S	-122	-
FC234-12	-5S	-14S	-16	-13C	-9	-280	-20	-16	-0630S	-157	-
FC234-16	-6S	-7S	-22	-14C	-24	-320	-20	-20	-0630S	-173	-
FC250H-04	-1S	-1S	-8	-	-01	-	-12	-8	-0622S	-68	A5953
FC250H-06	-1S	-13S	-10	-	-2	-137	-12	-10	-0622S	-79	A5962
FC250H-08	-12S	-3S	-12	-10C	-21	-160	-12	-12	-0622S	-91	A5975
FC250H-10	-15S	-4S	-12	-21C	-4	-190	-16	-13	-0622S	-106	A5984
FC250H-12	-3S	-5S	-16	-12C	-5	-222	-16	-16	-0622S	-122	-
FC250H-16	-5S	-6S	-22	--14C	-9	-280	-20	-20	-0648S	-173	-
FC254-08	-4S	-4S	-12	-	-6	-254	-20	-18	-0630S	-142	-
FC254-12	-6S	-6S	-16	-	-24	-320	-24	-26	-0648S	-173	-
FC254-16	-7S	-7S	-22	-	-10	-381	-28	-30	-0648S	-209	-
FC254-20	-8S	-9S	-22	-	-28	-445	-32	-32	-0648S	-288	-
FC254-24	-10S	-10S	-30	-	-29	-	-38	-38	-0648S	-366	-
FC254-32	-10S	-11S	-30	-	-31	-700	-54	-46	-0664C	-	-
FC273B-12	-6S	-14S	-16	-	-27	-300	-24	-22	-0648S	-173	-
FC273B-16	-7S	-7S	-22	-	-10	-381	-28	-30	-0648S	-209	-
FC273B-20	-8S	-8S	-30	-	-13	-508	-38	-38	-0648S	-288	-

*Sizes indicated are based on Hose O.D. only. If sleeve is to be placed over fittings, a larger sleeve size may be required, depending on type of fitting used.

Accessories to hose chart

Hose Part #	900564	900705	900952	222005 222022	900729	FF90311	FC425	624	FF9217	FF90754	A5950
	Steel protective coil spring*	Steel protective coil sleeve*	Plastic coil sleeve*	Internal support coil	Support clamp	Heavy duty support clamp	Nylon sleeve*	Fire-sleeve*	Band style clamp	Guardian sleeve*	Bend restrictor
											
FC273B-24	-10S	-10S	-30	-	-14	-572	-38	-38	-0648S	-366	-
FC273B-32	-11S	-11S	-30	-	-15	-700	-54	-46	-0664C	-	-
FC300-04	-1S	-1S	-6	-	-1	-137	-12	-11	-0622S	-79	A5962
FC300-05	-12S	-13S	-8	-	-2	-	-12	-12	-0622S	-79	A5969
FC300-06	-2S	-2S	-10	-	-21	-174	-16	-14	-0622S	-91	A5975
FC300-08	-14S	-3S	-12	-10C	-4	-190	-16	-16	-0622S	-98	A5984
FC300-10	-4S	-4S	-12	-21C	-6	-239	-20	-18	-0630S	-142	-
FC300-12	-5S	-5S	-16	-13C	-8	-280	-20	-20	-0630S	-157	-
FC300-16	-6S	-6S	-16	-14C	-27	-320	-24	-24	-0648S	-185	-
FC300-20	-7S	-7S	-22	-15C	-10	-381	-28	-30	-0648S	-209	-
FC300-24	-9S	-9S	-22	-17C	-12	-445	-32	-32	-0648S	-238	-
FC300-32	-10S	-10S	-30	-18C	-14	-572	-38	-38	-0648S	-366	-
FC300-40	-	-12S	-	-19C	-16	-	-	-	-	-	-
FC321-04	-1S	-1S	-6	-	-1	-137	-12	-11	-0622S	-79	A5962
FC321-05	-12S	-13S	-8	-	-2	-150	-12	-12	-0622S	-79	A5969
FC321-06	-2S	-2S	-10	-	-21	-174	-16	-14	-0622S	-91	A5975
FC321-08	-14S	-3S	-12	-10C	-4	-190	-16	-16	-0622S	-122	A5984
FC321-10	-4S	-4S	-12	-11C	-5	-239	-20	-18	-0630S	-122	-
FC321-12	-5S	-5S	-16	-13C	-8	-280	-20	-20	-0630S	-157	-
FC321-16	-6S	-6S	-16	-14C	-27	-320	-24	-22	-0630S	-173	-
FC332-04	-1S	-1S	-6	-	-	-127	-12	-9	-0622S	-68	A5962
FC332-06	-12S	-13S	-8	-	-21	-160	-16	-11	-0622S	-91	A5969
FC332-08	-14S	-3S	-10	-	-4	-190	-16	-13	-0622S	-98	A5984
FC332-10	-3S	-4S	-12	-	-5	-222	-20	-16	-0622S	-122	-
FC332-12	-5S	-5S	-12	-	-23	-266	-20	-18	-0630S	-157	-
FC350-04	-1S	-1S	-6	-	-1	-127	-12	-11	-0622S	-79	A5962
FC350-05	-12S	-13S	-8	-	-2	-150	-12	-12	-0622S	-79	A5969
FC350-06	-2S	-2S	-10	-	-21	-174	-16	-14	-0622S	-91	A5975
FC350-08	-14S	-3S	-12	-10C	-4	-190	-16	-16	-0622S	-106	A5984
FC350-10	0	-4S	-12	-21C	-6	-239	-20	-18	-0630S	-142	-
FC350-12	-5S	-5S	-5	-13C	-8	-280	-20	-20	-0630S	-157	-
FC350-16	-6S	-6S	-16	-14C	-27	-320	-24	-24	-0648S	-173	-
FC350-20	-7S	-7S	-22	-15C	-10	-381	-28	-30	-0648S	-209	-
FC350-24	-9S	-9S	-22	-17C	-12	-445	-32	-32	-0648S	-288	-
FC355-04	-1S	-1S	-6	-	-1	-127	-12	-11	-0622S	-79	A5962
FC355-05	-1S	-2S	-6	-	-1	-150	-12	-11	-0622S	-91	A5969
FC355-06	-12S	-1S	-8	-	-2	-174	-12	-12	-0622S	-91	A5975
FC355-08	-2S	-13S	-10	-	-3	-190	-16	-12	-0622S	-106	A5984
FC355-10	-3S	-3S	-12	-10C	-5	-239	-16	-13	-0622S	-142	-
FC355-12	-4S	-5S,-4S	-6	-21C	-6	-280	-20	-16	-0630S	-157	-











*Sizes indicated are based on Hose O.D. only. If sleeve is to be placed over fittings, a larger sleeve size may be required, depending on type of fitting used.

Accessories to hose chart

Hose Part #	900564	900705	900952	222005 222022	900729	FF90311	FC425	624	FF9217	FF90754	A5950
	Steel protective coil spring*	Steel protective coil sleeve*	Plastic coil sleeve*	Internal support coil	Support clamp	Heavy duty support clamp	Nylon sleeve*	Fire-sleeve*	Band style clamp	Guardian sleeve*	Bend restrictor
FC355-16	-5S	-6S	-16	-13C	-9	-320	-20	-20	-0630S	-173	-
FC355-20	-6S	-7S	-22	-14C	-24	-381	-24	-22	-0648S	-219	-
FC355-24	-7S	-7S	-22	-15C	-10	-445	-28	-30	-0648S	-288	-
FC355-32	-9S	-9S	-22	-17C	-12	-572	-32	-32	-0648S	-366	-
FC466-04	-1S	-1S	-6	-	-1	-127	-12	-9	-0622S	-68	A5962
FC466-06	-12S	-13S	-8	-	-21	-160	-16	-11	-0622S	-91	A5975
FC466-08	-14S	-3S	-10	-	-4	-190	-16	-13	-0622S	-98	A5984
FC466-10	-3S	-4S	-12	-	-5	-222	-20	-16	-0622S	-122	-
FC498/FC598-04	-1S	-1S	-6	-	-	-127	-12	-9	-0622S	-68	A5962
FC498/FC598-06	-12S	-13S	-8	-	-21	-160	-16	-11	-0622S	-91	A5969
FC498/FC598-08	-14S	-3S	-10	-	-4	-190	-16	-13	-0622S	-98	A5984
FC498/FC598-10	-3S	-4S	-12	-	-5	-222	-20	-16	-0622S	-122	-
FC498/FC598-12	-5S	-5S	-12	-	-23	-266	-20	-18	-0630S	-157	-
FC500-12	-7S	-14S	-16	-	-27	-300	-24	-22	-0648S	-173	-
FC500-16	-9S	-7S	-22	-	-10	-381	-32	-26	-0648S	-209	-
FC500-20	-10S	-8S	-22	-	-28	-	-38	-32	-0648S	-288	-
FC500-24	-10S	-10S	-30	-	-13	-	-40	-36	-0648S	-366	-
FC500-32	-8S	-11S	-30	-	-15	-700	-54	-48	-0664C	-	-
FC510-04	-12S	-1S	-6	-	-2	-137	-12	-12	-0622S	-79	A5962
FC510-06	-14S	-2S	-10	-	-4	-174	-12	-16	-0622S	-91	A5975
FC510-08	-3S	-3S	-12	-	-5	-205	-16	-16	-0630S	-106	A5984
FC510-10	-5S	-4S	-12	-	-6	-239	-20	-18	-0630S	-142	-
FC510-12	-6S	-5S	-16	-	-8	-280	-24	-20	-0630S	-157	-
FC510-16	-9S	-6S	-16	-	-25	-357	-28	-24	-0648S	-209	-
FC510-20	-9S	-8S	-30	-	-12	-422	-32	-30	-0648S	-238	-
FC579-04	-1S	-13S	-10	-23C	-1	-137	-12	-11	-0622S	-91	A5962
FC579-06	-15S	-4S	-12	-10C	-4	-190	-16	-14	-0622S	-122	A5984
FC606-16	-7S	-9S	-	-15C	-11	-400	-32	-30	-0648S	-288	-
FC606-20	-8S	-10S	-	-20C	-28	-483	-38	-38	-0648S	-366	-
FC606-24	-10S	-11S	-	-24C	-29	-508	-40	-42	-0648S	-366	-
FC611-08	-3S	-5S	-16	-21C	-5	-222	-18	-18	-0622S	-142	A5987
FC611-12	-5S	-14S	-22	-14C	-8	-266	-20	-20	-0648S	-173	-
FC611-16	-7S	-7S	-30	-15C	-25	-334	-24	-26	-0648S	-219	-
FC611-20	-9S	-8S	-	-20C	-11	-422	-32	-30	-0648S	-288	-
FC611-24	-8S	-10S	-	-24C	-28	-483	-38	-38	-0648S	-366	-
FC611-32	-13S	-11S	-	-	-30	-635	-46	-46	-0664C	-	-
FC619-12	-6S	-6S	-22	-14C	-9	-280	-24	-22	-0648S	-185	-
FC619-16	-7S	-7S	-30	-15C	-25	-357	-28	-26	-0648S	-219	-
FC619-20	-9S	-8S	-	-20C	-12	-445	-32	-32	-0648S	-288	-
FC619-24	-8S	-10S	-	-24C	-13	-508	-38	-38	-0648S	-366	-











*Sizes indicated are based on Hose O.D. only. If sleeve is to be placed over fittings, a larger sleeve size may be required, depending on type of fitting used.

Accessories to hose chart

Hose Part #	900564	900705	900952	222005 222022	900729	FF90311	FC425	624	FF9217	FF90754	A5950
	Steel protective coil spring*	Steel protective coil sleeve*	Plastic coil sleeve*	Internal support coil	Support clamp	Heavy duty support clamp	Nylon sleeve*	Fire-sleeve*	Band style clamp	Guardian sleeve*	Bend restrictor
											
FC619-32	-13S	-11S	-	-	-30	-635	-46	-46	-0664C	-	-
FC619-40	-	-	-	-40C	-16	-700	-54	-54	-0664C	-	-
FC619-48	-	-	-	-48C	-17	-	-	-	-	-	-
FC636-12	-6S	-6S	-22	-14C	-27	-300	-24	-22	-0648S	-185	-
FC636-16	-7S	-9S	-30	-	-25	-357	-28	-26	-0648S	-219	-
FC636-20	-9S	-8S	-	-20C	-28	-445	-32	-32	-0648S	-288	-
FC636-24	-8S	-10S	-	-24C	-29	-508	-38	-38	-0648S	-366	-
FC639-06	-2S	-2S	-10	-	-3	-174	-16	-14	-0622S	-91	A5975
FC639-08	-15S	-3S	-10	-	-5	-205	-16	-16	-0622S	-122	A5987
FC639-10	-4S	-5S	-16	-	-6	-239	-20	-20	-0630S	-142	-
FC639-12	-5S	-6S	-16	-14C	-9	-280	-22	-22	-0648S	-173	-
FC639-16	-7S	-7S	-22	-15C	-10	-357	-24	-28	-0648S	-209	-
FC647-04	-1S	-1S	-6	-	-1	-127	-12	-9	-0622S	-68	A5962
FC647-06	-12S	-13S	-8	-	-21	-160	-16	-11	-0622S	-91	A5969
FC647-08	-14S	-3S	-10	-	-4	-190	-16	-13	-0622S	-106	A5984
FC647-10	-3S	-4S	-12	-	-5	-222	-20	-16	-0622S	-122	-
FC647-12	-5S	-5S	-12	-	-23	-266	-20	-18	-0630S	-157	-
FC650-04	-1S	-1S	-6	-	-1	-	-12	-11	-0622S	-68	A5953
FC650-06	-2S	-2S	-10	-	-21	-160	-16	-14	-0622S	-91	A5969
FC650-08	-14S	-3S	-12	-10C	-4	-190	-16	-16	-0622S	-98	A5984
FC650-10	-3S	-3S	-12	-	-5	-205	-16	-16	-0622S	-122	A5987
FC650-12	-4S	-5S	-16	-	-6	-254	-20	-20	-0630S	-142	-
FC693-04	-1S	-13S	-8	-	-2	-	-12	-12	0622S	-79	A5969
FC693-06	-1S	-2S	-10	-	-4	-	-16	-16	-0622S	-98	A5984
FC693-08	-3S	-3S	-12	-	-5	-	-18	-18	-0622S	-122	-
FC699-04	-12S	-1S	-6	-	-2	-	-12	-12	-0622S	-68	A5962
FC699-06	-14S	-2S	-10	-	-4	-174	-16	-16	-0622S	-91	A5969
FC699-08	-3S	-3S	-12	-	-5	-205	-16	-16	-0630S	-106	A5984
FC699-10	-4S	-4S	-12	-	-6	-239	-20	-18	-0630S	-142	-
FC699-12	-5S	-5S	-16	-	-8	-280	-20	-22	-0630S	-157	-
FC735-04	-1S	-1S	-6	-	-1	-127	-12	-11	-0622S	-68	A5962
FC735-06	-2S	-2S	-10	-	-3	-171	-16	-16	-0622S	-91	A5975
FC735-08	-15S	-3S	-10	-	-5	-205	-16	-16	-0622S	-122	A5987
FC735-10	-4S	-4S	-12	-	-6	-254	-20	-18	-0630S	-142	-
FC735-12	-5S	-14S	-16	-	-9	-280	-24	-22	-0648S	-173	-
FC735-16	-7S	-7S	-22	-15C	-10	-357	-24	-28	-0648S	-185	-
FC735-20	-7S	-9S	-22	-	-12	-422	-28	-28	-0648S	-288	-
FC736-06	-3S	-3S	-12	-	-5	-205	-16	-16	-0630S	-122	-
FC736-08	-4S	-4S	-12	-	-6	-239	-20	-18	-0630S	-142	-
FC736-10	-5S	-5S	-16	-	-8	-280	-20	-20	-0630S	-157	-











*Sizes indicated are based on Hose O.D. only. If sleeve is to be placed over fittings, a larger sleeve size may be required, depending on type of fitting used.

Accessories to hose chart

Hose Part #	900564	900705	900952	222005 222022	900729	FF90311	FC425	624	FF9217	FF90754	A5950
	Steel protective coil spring*	Steel protective coil sleeve*	Plastic coil sleeve*	Internal support coil	Support clamp	Heavy duty support clamp	Nylon sleeve*	Fire-sleeve*	Band style clamp	Guardian sleeve*	Bend restrictor
											
FC736-12	-6S	-6S	-16	-	-24	-300	-24	-26	-0630S	-209	-
FC736-16	-7S	-7S	-22	-	-11	-381	-28	-28	-0630S	-288	-
FC736-20	-8S	-8S	-22	-	-28	-	-32	-30	-0648S	-288	-
FC800-12	-6S	-14S	-16	-12C	-9	-266	-18	-18	-0622S	-157	-
FC800-16	-7S	-7S	-22	-13C	-10	-300	-24	-22	-0648S	-209	-
FC800-20	-7S	-7S	-30	-20C	-11	-357	-24	-26	-0648S	-238	-
FC800-24	-9S	-10S	-	-17C	-28	-445	-32	-30	-0648S	-288	-
FC839B-04	-1S	-1S	-6	-	-1	-127	-12	-11	-0622S	-68	A5962
FC839B-06	-12S	-2S	-10	-	-21	-160	-16	-14	-0622S	-91	A5975
FC839B-08	-14S	-3S	-12	-	-5	-205	-16	-18	-0622S	-122	A5987
FC839B-10	-4S	-5S	-16	-	-6	-239	-20	-20	-0630S	-142	-
FC839B-12	-5S	-6S	-16	-	-9	-280	-22	-22	-0648S	-173	-
FC839B-16	-7S	-7S	-22	-	-10	-381	-28	-30	-0648S	-209	-
FC849-04	-1S	-2S	-10	-23C	-2	-137	-16	-11	-0622S	-91	-
FC849-06	-15S	-4S	-12	-10C	-3	-174	-16	-14	-0622S	-106	-
FC849-08	-3S	-4S	-16	-21C	-5	-205	-18	-16	-0622S	-142	-
FC849-10	-4S	-5S	-16	-12C	-23	-254	-20	-20	-0648S	-157	-
FC849-12	-5S	-6S	-22	-14C	-9	-280	-24	-22	-0648S	-185	-
FC849B-04	-1S	-2S	-10	-23C	-2	-137	-16	-11	-0622S	-91	A5969
FC849B-06	-15S	-4S	-12	-10C	-3	-174	-16	-14	-0622S	-106	A5984
FC849B-08	-3S	-4S	-16	-21C	-5	-205	-18	-16	-0622S	-142	-
FC849B-10	-4S	-5S	-16	-12C	-23	-254	-20	-20	-0648S	-157	-
FC849B-12	-5S	-6S	-22	-14C	-9	-280	-24	-22	-0648S	-185	-
GH100-4	-1S	-1S	-6	-	-	-127	-12	-9	-0622S	-79	A5962
GH100-6	-12S	-13S	-8	-	-21	-160	-16	-11	-0622S	-98	A5969
GH100-8	-14S	-3S	-10	-	-4	-190	-16	-13	-0622S	-98	A5984
GH100-10	-3S	-4S	-12	-	-5	-222	-20	-16	-0622S	-122	-
GH100-12	-5S	-5S	-12	-	-23	-266	-20	-18	-0630S	-157	-
GH120-4	-1S	-13S	-8	-	-2	-137	-12	-12	-0622S	-79	A5962
GH120-6	-2S	-2S	-10	-	-3	-171	-16	-16	-0622S	-91	A5975
GH120-8	-14S	-3S	-12	-	-5	-205	-16	-18	-0622S	-122	A5987
GH120-10	-4S	-5S	-16	-	-6	-239	-20	-20	-0630S	-142	-
GH120-12	-5S	-6S	-16	-	-9	-280	-22	-22	-0648S	-173	-
GH120-16	-7S	-7S	-22	-	-10	-357	-24	-28	-0648S	-209	-
GH120-20	-9S	-8S	-30	-	-	-422	-32	-30	-0648S	-288	-
GH120-24	-10S	-15S	-30	-	-29	-508	-38	-38	-0648S	-288	-
GH120-32	-13S	-12S	-30	-	-30	-635	-46	-46	-0664C	-	-
GH194-4	-1S	-1S	-6	-	-1	-137	-12	-11	-0622S	-79	A5962
GH194-6	-2S	-2S	-10	-	-3	-174	-16	-14	-0622S	-91	A5975
GH194-8	-15S	-3S	-10	-	-5	-205	-16	-16	-0622S	-122	A5987











*Sizes indicated are based on Hose O.D. only. If sleeve is to be placed over fittings, a larger sleeve size may be required, depending on type of fitting used.

Accessories to hose chart

Hose Part #	900564	900705	900952	222005 222022	900729	FF90311	FC425	624	FF9217	FF90754	A5950
	Steel protective coil spring*	Steel protective coil sleeve*	Plastic coil sleeve*	Internal support coil	Support clamp	Heavy duty support clamp	Nylon sleeve*	Fire-sleeve*	Band style clamp	Guardian sleeve*	Bend restrictor
											
GH194-10	-4S	-4S	-12	-	-6	-239	-20	-18	-0630S	-142	-
GH194-12	-4S	-4S	-12	-	-6	-	-20	-18	-0633S	-157	-
GH194-16	-6S	-6S	-22	-	-25	-357	-24	-26	-0648S	-209	-
GH194-20	-9S	-8S	-30	-	-1	-445	-32	-30	-0648S	-288	-
GH194-24	-8S	-8S	-30	-	-13	-508	-38	-38	-0648S	-288	-
GH194-32	-13S	-12S	-30	-	-30	-635	-46	-46	-0664C	-	-
GH195-4	-12S	-13S	-8	-	-2	-150	-15	-11	-0622S	-79	A5969
GH195-6	-14S	-2S	-10	-	-4	-190	-16	-13	-0622S	-98	A5984
GH195-8	-3S	-3S	-12	-	-5	-222	-18	-16	-0622S	-122	-
GH195-10	-6S	-5S	-16	-	-6	-266	-20	-18	-0630S	-142	-
GH195-12	-7S	-6S	-16	-	-9	-300	-24	-20	-0648S	-173	-
GH195-16	-9S	-9S	-22	-	-10	-381	-32	-26	-0648S	-209	-
GH195-20	-10S	-10S	-30	-	-12	-483	-38	-32	-0664C	-288	-
GH195-24	-10S	-11S	-30	-	-13	-	-40	-36	-0648S	-366	-
GH195-32	-11S	-12S	-30	-	-30	-635	-54	-46	-0664C	-	-
GH466-20	-10S	-8S	-30	-	-13	-508	-38	-36	-0648S	-288	-
GH493-6	-15S	-3S	-12	-	-5	-205	-16	-16	-0622S	-106	-
GH493-8	-3S	-4S	-12	-	-6	-239	-20	-20	-0648S	-122	-
GH493-10	-4S	-5S	-16	-	-8	-280	-20	-22	-0648S	-157	-
GH493-12	-5S	-6S	-16	-	-27	-300	-24	-24	-0648S	-173	-
GH493-16	-7S	-7S	-22	-	-10	-381	-28	-28	-0648S	-209	-
GH493-20	-8S	-10S	-22	-	-28	-	-32	-38	-0648S	-288	-
GH493-24	-8S	-10S	-30	-	-29	-	-38	-38	-0648S	-366	-
GH493-32	-13S	-11S	-30	-	-31	-	-46	-46	-0664S	-	-
GH506-12	-7S	-6S	-16	-	-24	-320	-24	-50	-0648S	-173	-
GH506-16	-9S	-7S	-22	-	-10	-381	-32	-26	-0648S	-209	-
GH663-3	-1S	-1S	-8	-	-01	-	-12	-9	-0622S	-79	A5953
GH663-4	-1S	-13S	-10	-23C	-1	-127	-12	-10	-0622S	-91	A5962
GH663-5	-1S	-2S	-10	-23C	-2	-137	-16	-11	-0622S	-91	A5969
GH663-6	-2S	-3S	-12	-10C	-21	-171	-16	-13	-0622S	-98	A5975
GH663-8	-14S	-4S	-12	-21C	-4	-190	-16	-16	-0622S	-142	A5987
GH663-10	-4S	-5S	-16	-12C	-5	-222	-18	-18	-0622S	-157	-
GH663-12	-5S	-14S	-22	-14C	-8	-266	-20	-20	-0648S	-173	-
GH663-16	-7S	-7S	-30	-15C	-25	-334	-24	-26	-0648S	-219	-
GH663-20	-9S	-8S	-	-20C	-11	-422	-32	-30	-0648S	-288	-
GH663-24	-8S	-10S	-	-24C	-28	-483	-38	-38	-0648S	-366	-
GH663-32	-13S	-11S	-	-	-30	-635	-46	-46	-0664C	-	-
GH681-3	-1S	-1S	-6	-	-1	-	-12	-11	-0622S	-68	A5953
GH681-4	-1S	-1S	-6	-	-1	-127	-15	-11	-0622S	-68	A5962
GH681-5	-1S	-1S	-6	-	-1	-137	-12	-11	-0622S	-79	A5962

*Sizes indicated are based on Hose O.D. only. If sleeve is to be placed over fittings, a larger sleeve size may be required, depending on type of fitting used.

Accessories to hose chart

Hose Part #	900564	900705	900952	222005 222022	900729	FF90311	FC425	624	FF9217	FF90754	A5950
	Steel protective coil spring*	Steel protective coil sleeve*	Plastic coil sleeve*	Internal support coil	Support clamp	Heavy duty support clamp	Nylon sleeve*	Fire-sleeve*	Band style clamp	Guardian sleeve*	Bend restrictor
											
GH681-6	-12S	-2S	-10	-	-21	-160	-16	-14	-0622S	-91	A5975
GH681-8	-14S	-3S	-12	-	-4	-205	-20	-16	-0622S	-98	A5984
GH681-10	-3S	-3S	-12	-	-5	-205	-20	-16	-0622S	-122	-
GH681-12	-4S	-5S	-16	-	-6	-254	-24	-20	-0630S	-142	-
GH681-16	-5S	-6S	-16	-13C	-9	-320	-32	-20	-0630S	-173	-
GH681-20	-7S	-7S	-22	-14C	-11	-400	-38	-30	-0648S	-238	-
GH681-24	-8S	-10S	-30	-	-12	-483	-40	-32	-0664C	-288	-
GH681-32	-13S	-12S	-30	-	-30	-635	-54	-46	-0664C	-	-
GH781-4	-1S	-13S	-8	-	-2	-137	-15	-12	-0622S	-79	A5962
GH781-6	-2S	-2S	-10	-	-3	-174	-16	-16	-0622S	-91	A5975
GH781-8	-14S	-3S	-12	-	-5	-205	-20	-18	-0622S	-142	A5987
GH781-10	-5S	-5S	-12	-	-6	-239	-24	-18	-0630S	-142	-
GH781-12	-6S	-14S	-16	-	-9	-280	-24	-20	-0648S	-173	-
GH781-16	-9S	-7S	-22	-	-10	-357	-28	-24	-0648S	-209	-
GH781-20	-9S	-9S	-22	-	-12	-422	-32	-30	-0648S	-288	-
GH781-24	-10S	-8S	-30	-	-13	-508	-38	-36	-0648S	-366	-
GH781-32	-11S	-12S	-30	-	-30	-635	-54	-46	-0664C	-	-
GH793-4	-1S	-13S	-8	-	-2	-150	-12	-12	-0622S	-79	A5969
GH793-6	-15S	-2S	-10	-	-4	-190	-16	-16	-0622S	-98	A5984
GH793-8	-3S	-3S	-12	-	-5	-222	-16	-18	-0622S	-122	-
GH793-10	-4S	-5S	-16	-	-6	-266	-20	-20	-0630S	-157	-
GH793-12	-5S	-6S	-16	-	-9	-300	-20	-22	-0648S	-173	-
GH793-16	-7S	-9S	-22	-	-10	-381	-24	-28	-0648S	-209	-
GH793-20	-8S	-10S	-30	-	-12	-483	-32	-32	-0664C	-288	-
GH793-24	-10S	-10S	-30	-	-13	-	-38	-38	-0648S	-366	-
GH793-32	-13S	-12S	-30	-	-30	-635	-46	-46	-0664C	-	-
H20104	-1S	-1S	-6	-	-	-127	-12	-9	-0622S	-68	A5962
H20106	-12S	-13S	-8	-	-21	-160	-16	-11	-0622S	-98	A5962
H20108	-14S	-3S	-10	-	-4	-190	-16	-13	-0622S	-68	A5975
H20110	-3S	-4S	-12	-	-5	-222	-20	-16	-0622S	-122	A5984
H20112	-5S	-5S	-12	-	-23	-266	-20	-18	-0630S	-157	-
H20116	-6S	-7S	-30	-16C	-25	-334	-24	-24	-0648S	-157	-
WH004-12	-5S	-6S	-22	-14C	-8	-280	-24	-22	-0648S	-185	-
WH004-16	-7S	-7S	-30	-15C	-25	-334	-24	-26	-0648S	-219	-
WH004-20	-7S	-9S	-	-20C	-11	-400	-32	-30	-0648S	-288	-
WH004-24	-8S	-10S	-	-24C	-28	-483	-38	-38	-0648S	-366	-
WH004-32	-13S	-11S	-	-	-14	-572	-46	-42	-0648S	-	-
WH004-40	-	-	-	-40C	-16	-	-54	-50	-0664C	-	-
WH004-48	-	-	-	-48C	-17	-	-59	-60	-0664C	-	-

*Sizes indicated are based on Hose O.D. only. If sleeve is to be placed over fittings, a larger sleeve size may be required, depending on type of fitting used.

Aeroquip by Danfoss

Machines and tooling



Crimp machines

Core crimp machines

With the Danfoss-branded core crimp machine portfolio, all customers have access to the same crimp machines and tooling. This simplified and improved offering includes lower cost options as well as both positive stop and variable machines to meet all of your application needs. Compare our new offering of crimp machines and their associated features to understand which crimper is best for you.

Quick reference crimp machine comparison chart



Crimp Machines				
Production volume	Low	Low	Medium	Medium
Type	Variable	Positive stop	Variable	Positive stop
Capability-braided "up to"	1-1/4	1"	1-1/4"	1-1/4"
Capability-spiral "up to"	1"	1"	1-1/4"	1-1/4"
Capability-industrial "up to"	1-1/4"	1"	1-1/4"	1-1/4"
Application	Portable, job shops, maintenance departments	Portable, job shops, maintenance departments	Hose distributors, small assembly shops	Hose distributors, small assembly shops, factory, construction, mines
*Pump options	110v, air/hydraulic, 12v, hand pump	110v, air/hydraulic, 12v, hand pump	115v, 230v	110v, 220v

*Capabilities based on Danfoss core hose and fitting products

*See pump ordering options for each machine for specific kit numbers

Core crimp machines (cont.)

Quick reference crimp machine comparison chart

<p>Crimp Machines</p>			
<p>Production volume</p>	<p>Medium/high</p>	<p>Medium</p>	<p>High</p>
<p>Type</p>	<p>Variable</p>	<p>Positive stop</p>	<p>Variable</p>
<p>Capability-braided (up to)</p>	<p>2"</p>	<p>2"</p>	<p>3"</p>
<p>Capability-spiral (up to)</p>	<p>2"</p>	<p>2"</p>	<p>2.5"</p>
<p>Capability-industrial (up to)</p>	<p>2"</p>	<p>2"</p>	<p>4"</p>
<p>Application</p>	<p>Hose distributors, assembly shops</p>	<p>Hose distributors, assembly shops, construction, mines</p>	<p>Industrial production facility, specialty</p>
<p>*Pump options</p>	<p>115v, 230v</p>	<p>220v</p>	<p>230v, 380v, 400v, 420v, 440v, 460v, 480v</p>

*Capabilities based on Danfoss core hose and fitting products

*See pump ordering options for each machine for specific kit numbers

Crimp machines

ET1187

Portable crimp machine

The ET1187 machine is our most economical variable crimp machine to date. It boasts a broad crimp capability with a new "ease-of-use" that is sure to excite hose assemblers in the field.



This machine is designed to easily adjust to Danfoss' core products. It's as simple as turning the collar to the correct color to match the layline on the hose, adjust the ring so that the correct size dot aligns with the correct size line on the collar and the machine is set for the correct crimp. Load the correct crimp die based on the crimp die chart attached to the machine, and the machine is ready to crimp.

Tooling	Tooling capabilities			Tooling packages	
	1 wire braid: 1A/Winner	2 wire braid: 1A/Winner	4 wire spiral: 4S	ET4020TP-0002	ET4020TP-0003
Die cage part #					
FT1380-200-M150	-4	-4		X	X
FT1380-200-M180	-6	-4†		X	X
FT1380-200-M210	-8	-6	-6	X	X
FT1380-200-M240	-10	-8	-8††	X	X
FT1381-200-M280	-12	-10, -12†	-8, -10	X	X
FT1380-200-M320		-12	-12	X	X
FT1380-200-M370	-16	-16		X	X
FT1380-200-M420			-16		X
FT1382-200-M465	-20	-20			X

†Die cage used to crimp Winner hose with two piece Winner fitting

††Die cage used to crimp Winner hose with 4S fitting

*Consult the PowerSource Crimp Spec tool for the die cage needed to crimp -16 Winner two piece fittings

NOTE: Visit the Danfoss PowerSource Crimp Specs tool at danfoss.com/crimp to find the tooling needed for all of the hoses and fittings you plan to crimp

Specifications

Dimensions:

22" high x 9" wide x 11" deep

Weight: 65 lbs

Available with bench and truck mount brackets



Bench mount

Truck mount

Capabilities

• **Braided hose:** -4 thru -20

• **Spiral hose:** -6 thru -16

Features

• Can be mounted on service vehicles or bench tops

• Can be used remotely, 65lbs

• Can be powered with virtually any 10,000 psi hydraulic power source (minimum of 36 cu. inch pump reservoir capacity is required)

• Utilizes existing FT1380 dies

Benefits

• Color-coded collar for core hose products makes setup fast and easy

• Easily transported between job sites

• Versatile power source options

• Lower investment cost than other variable crimpers

• Comes with high efficiency PTFE grease

ET1187

Portable crimp machine

ET1187-001

Bench mount machine, no pump, no tooling (includes bracket) — for premium hose GH681/H180, GH781/H280, GH493/H430

ET1187-002

Truck mount machine, no pump, no tooling (includes bracket) — for premium hose GH681/H180, GH781/H280, GH493/H430

ET1187-003

Bench mount machine, no pump, no tooling (includes bracket) — for Winner hose EC115, EC215, EC118

ET1187-004

Truck mount machine, no pump, no tooling (includes bracket) — for Winner hose EC115, EC215, EC118

ET1187-008

Contains ET1187 Bench mount machine (includes bracket) for premium hose, 110v pump kit, and ET4020TP-0002 tooling package

ET1187-010

Contains ET1187-001 bench mount crimper, ET9000-45-110 portable saw, 110v pump, ET4020TP-0002 tooling package, and the ET1187-0029 crimper portability kit

ET1000PK-001

2-Stage hand pump

ET1000PK-002

Air/hydraulic pump

ET1000PK-003

110v electric pump

ET1000PK-004

12v DC electric pump

*These pump kits include the pump, connecting hose assembly, and all of the adapters necessary to connect the pump to the ET1187 crimp machine

T-400-G

1.5 oz. tube, high efficiency PTFE grease

FF91455

16 oz. can, high efficiency PTFE grease

ET1187C-0008PR

Replacement barrel for the ET1187-001 or ET1187-002 machine (for premium hose GH681/H180, GH781/H280, GH493/H430)

ET1187C-0008PR2

Replacement barrel for the ET1187-001 or ET1187-002 machine (for premium hose GH681/H180, GH781/H280, EC881/H881)

ET1187C-0008WR

Replacement barrel for the ET1187-003 or ET1187-004 machine (for Winner hose EC115, EC215, EC118)

ET1187C-0009PR

Replacement knob for the ET1187-001 or ET1187-002 machine (for premium hose GH681/H180, GH781/H280, GH493/H430)

ET1187C-0009PR2

Replacement knob for the ET1187-001 or ET1187-002 machine (for premium hose GH681/H180, GH781/H280, EC881/H881)

ET1187C-0009WR

Replacement knob for the ET1187-003 or ET1187-004 machine (for Winner hose EC115, EC215, EC118)

ET1187C-0017

Bench mount bracket (separate)

ET1187C-0019

Truck mount bracket (separate)

ET1187C-0028 Handle kit

Includes 2 easy grip handles and mounting hardware

ET1187C-0029 Portability kit

Includes handle kit, longer hose assembly, and FF series QD couplings

FT1380DR-12 Lazy Susan die rack

Holds twelve FT1380 dies

ET1187C-COVER

Crimper Cover

Place your order for the desired machine, pump, and tooling separately, following the chart below
OR order a machine package with tooling and include the part number ET1187-008 and part number ET1187-010.

Tooling can also be ordered a la carte.

Visit the Danfoss PowerSource Crimp Specs tool at danfoss.com/crimp to find the tooling needed for all of the hoses and fittings you plan to crimp.

ET1187 ordering		
Select your base machine	Select your pump kit	Select your tooling package
ET1187-001 Base machine with bench mount only	ET1000PK-003 110v pump kit	ET4020TP-0002
ET1187-002 Base machine with truck mount only	ET1000PK-002 A/H pump kit	ET4020TP-0003
ET1187-003 Base machine with bench mount only (for Winner hose EC115, EC215, EC118)	ET1000PK-004 12v pump kit	
ET1187-004 Base machine with truck mount only (for Winner hose EC115, EC215, EC118)	ET1000PK-001 Hand pump kit	

Package with tooling
Order a machine package with tooling
ET1187-008
ET1187-010

Note: All available pump kits shown include hose assembly and are CSA compliant

Crimp machines

ET1000

Portable crimp machine

The portable ET1000 crimp machine boasts a broad crimp capability with an ease-of-use that is sure to please hose assemblers. With four pump options—air/hydraulic, hand, 110v, or 12v DC—this portable machine can travel to the worksite. The machine comes equipped with a stand pre-drilled for mounting to a workbench or table-top.



Tooling	Tooling capabilities			Tooling packages	
	1 wire braid 1A/Winner	2 wire braid 1A/Winner	4 wire spiral 4S	*ET1000TP-1002 New placement package	*ET1000TP-1001 Conversion package
Die cage part #					
ET313DC-4Z	-4	-4		X	X
ET313DC-5Z	-5	-5			
ET313DC-6Z	-6	-6		X	X
ET313DC-8Z	-8	-8		X	X
ET313DC-10Z	-10	-10			
ET1000DC-12Z	-12	-12		X	X
ET1000DC-16Z	-16	-16		X	X
ET313DC-4S6			-6		
ET313DC-4S8			-8	X	X
ET313DC-4S10			-10		
ET1000DC-4S12			-12	X	X
ET1000DC-4S16			-16	X	X

*ET1000TP-1002 includes the following spacer rings—ET425SR-150A, ET313SR-090A, ET313SR-030D

*ET1000TP-1002 includes pusher extension—ET1000C-0012

*ET1000TP-1002 includes adapter ring—ET1000AR-001

*ET1000TP-1001 includes the following spacer rings—ET425SR-150A, ET313SR-090A

NOTE: Visit the Danfoss PowerSource Crimp Specs tool at danfoss.com/crimp to find the tooling needed for all of the hoses and fittings you plan to crimp

Specifications

Dimensions:
22" high x 16" wide x 14" deep

Weight: 65 lbs

Available with bench and truck mount brackets



Bench mount Truck mount

Capabilities

- **Braided hose:** -4 thru -16
- **Spiral hose:** -6 thru -16

Features

- Portable, positive stop, economical
- Can be mounted on service vehicles
- Utilizes 2-piece collet assemblies
- Spacer rings control the crimp diameter

Benefits

- Sliding pusher allows for easier fitting insertion into the machine
- Simple positive-stop crimp diameter control system for consistent crimping time after time with no operator adjustments required
- Easily transported between job sites
- Versatile power source options
- Electricity is required only when using an electric pump
- Comes with high efficiency PTFE grease

ET1000

Portable crimp machine

ET1000-001

Base machine

ET1000-020

Contains ET1000 crimper, / 110v pump kit, and ET1000TP-1002 tooling package

ET1000-021

Contains ET1000 crimper, air/hydraulic pump kit, and ET1000TP-1002 tooling package

ET1000-022

Contains ET1000-001 bench mount crimper, ET9000-45-110 portable saw, 110v pump, ET4020TP-0002 tooling package, and the ET1187-0029 crimper portability kit

ET1000PK-001

Hand pump

ET1000PK-002

Air/hydraulic pump

ET1000PK-003

110 volt electric pump

ET1000PK-004

12 volt DC electric pump

*Pump kits contain hose assembly and fittings to attach pump to machine

T-400-G

1.5 oz. tube high efficiency PTFE grease

FF91455

16 oz. can, high efficiency PTFE grease

ET1187C-0028 Handle kit

Includes 2 easy grip handles and mounting hardware

ET1187C-0029 Portability kit

Includes handle kit, longer hose assembly, and FF series QD couplings

ET1000C-0021

Wall bracket

ET1000C-0001

Bench mount bracket (included with base machine)

For your convenience, we have created one to two optimized machine and tooling package options for each of the core crimp machines. **If the available options do not meet your needs, place your order for the desired machine, pump, and tooling separately,** following the chart below.

Tooling can also be ordered a la carte. Visit the Danfoss PowerSource Crimp Specs tool at danfoss.com/crimp to find the tooling needed for all of the hoses and fittings you plan to crimp.

ET1000 ordering		
Select your base machine	Select your pump kit	Select your tooling package
ET1000-001 Base ET1000 Machine	ET1000PK-003 110v pump kit	ET1000TP-1002 New placement tooling package
	ET1000PK-002 A/H pump kit	ET1000TP-1001 Conversion tooling package
	ET1000PK-004 12v pump kit	
	ET1000PK-001 Hand pump kit	

Package with tooling
Order a machine package with tooling
ET1000-020
ET1000-021
ET1000-022

NOTE: All available pump kits shown include hose assembly and are CSA compliant

Crimp machines

FT1380/FT1380e

General purpose crimp machine

The FT1380 crimp machine from Danfoss crimps all your hose needs up to and including -20 spiral wire hose. The FT1380 is electronically controlled to give fast, accurate crimps the first time and every time you need a hose assembly. The electronic keypad is easy to adjust, with up to 10 programmable crimp settings. For hose styles and sizes used less frequently, simply enter the 3 digit code of that hose.

For FT1380e specifications and ordering details, please refer to:
FT1380e Electronic Crimper by Danfoss: Spec Sheet AV418159937321en-000201



Tooling	Tooling Capabilities				Tooling Packages	
	1 wire braid 1A/Winner	2 wire braid 1A/Winner	4 wire spiral 4S	6 wire spiral 6S	ET4020TP-0002	ET4020TP-0003
Die cage part #						
FT1380-200-M150	-4	-4			X	X
FT1380-200-M180	-6	-4 [†]			X	X
FT1380-200-M210	-8	-6	-6		X	X
FT1380-200-M240	-10	-8	-8 ^{††}		X	X
FT1381-200-M280	-12	-10,-12 [†]	-8,-10		X	X
FT1380-200-M320		-12	-12		X	X
FT1380-200-M370	-16	-16			X	X
FT1380-200-M420			-16			X
FT1382-200-M465	-20	-20	-20	-16		X
FT1382-275-M520				-20		

[†]Die cage used to crimp designated hose diameter with two piece Winner fitting

^{††}Die cage used to crimp Winner hose with 4S fitting

*Consult the PowerSource Crimp Spec tool for the die cage needed to crimp -16 Winner two piece fittings

NOTE: Visit the Danfoss PowerSource Crimp Specs tool at danfoss.com/crimp to find the tooling needed for all of the hoses and fittings you plan to crimp

FT1380-115/FT1380e-115

Base machine with 115v pump

FT1380-115CSA/FT1380e-115CSA

Base machine with 115v pump,
CSA approved

FT1380-230/FT1380e-230

Base machine with 230v pump

FT1380-230CSA/FT1380e-230CSA

Base machine with 230v pump, CSA approved

All pumps are included with machine purchase.

To review machine and pump package options please refer to the ordering options on the following page.

FT1380-115-8

Contains FT1380 crimper, 115v pump, and ET4020TP-0003 tooling package

FT1380-115-8CSA

Contains FT1380 crimper, 115v pump, and ET4020TP-0003 tooling package, CSA approved

FT1380e-115-9

Contains FT1380e crimper, 115v pump, and ET4020TP-0003 tooling package

FT1380e-115-9CSA

Contains FT1380e crimper, 115v pump, and ET4020TP-0003 tooling package, CSA approved

Specifications

Dimensions:

28.5" high x 12.75" wide x 25.75" deep

Weight: 238 lbs.

Capabilities

- **Braided hose:** -4 thru -20
- **Spiral hose:** -6 thru -20

Features

FT1380e

- FT1380e model features pre-loaded crimp specs, unlimited favorites, color assembly photos, and administrator capabilities

FT1380/FT1380e

- User-friendly operation to minimize training and mistakes
- Pre-set crimp settings and simple die cage insertion reduce setup time
- Electronic controls for minimal maintenance
- Upright design for easy hose insertion
- Compact design that requires little space

Benefits

FT1380e

- FT1380e model increases operator safety, speeds up assembly process, and reduces operator error and waste

FT1380/FT1380e

- Easy and quick to electronically enter crimp settings
- Can pre-program 10 most popular crimp settings
- Die cages easily slip in and out of machine
- Comes with high efficiency PTFE grease
- FT1380e comes with USB drive, stylus, and microfiber cloth

FT1380/FT1380e

General purpose crimp machine

FT1380-2-4

Optional die holder kit—kit includes 4 die holder plates each of which will hold 2 die cages. Holes are pre-drilled on base of FT1380 machine to accept these 4 plates. Not intended for use with the FT1380e electronic crimp machine.

FT1380-4

Optional fitting backstop—kit includes backstop and 5/32" hex wrench. The backstop allows the FT1380 to crimp PTFE hose and to be utilized for a fitting locator to increase efficiency.

FT1330-XL

1A fitting locators

FT1380-XL

4S fitting locators

T-400-G

1.5 oz. tube high efficiency PTFE grease

FF91455

16 oz. can, high efficiency PTFE grease

FT1380-2-9

Die cage repair kits for FT1380-200-size, FT1380-275-size

FF91042 Crimper cart

FT1380DR-12 Lazy Susan die rack

Holds twelve FT1380 dies

Standard FT1380 crimpers can be upgraded to the FT1380e electronic platform.

FT1380e-115-UP

FT1380e-115-UPCSA

FT1380e-230-UP

FT1380e-230-UPCSA

For your convenience, we have created one to two optimized machine and tooling package options for each of the core crimp machines. **If the available options do not meet your needs, place your order for the desired machine, pump, and tooling separately,** following the chart below.

Tooling can also be ordered a la carte. Visit the Danfoss PowerSource Crimp Specs tool at danfoss.com/crimp to find the tooling needed for all of the hoses and fittings you plan to crimp.

FT1380/FT1380e ordering		
Select your base machine	Pump included	Select your tooling package
FT1380-115/FT1380e-115 Base machine with 115v pump	115v pump included	ET4020TP-0003
FT1380-115CSA/FT1380e-115CSA Base machine with 115v pump, CSA approved	115v pump included	ET4020TP-0002
FT1380-230/FT1380e-230 Base machine with 230v pump	230v pump included	
FT1380-230CSA/FT1380e-230CSA Base machine with 230v pump, CSA approved	230v pump included	

Package with tooling
Order a machine package with tooling:
FT1380-115-8
FT1380-115-8CSA
FT1380e-115-9
FT1380e-115-9CSA

Note: Consider an alternative positive stop machine when crimping large quantities of -20 90 degree fittings.

Specialty crimp die cages		
Tooling	Tooling capabilities	
Die cage part #	Hose size	Hose style
FT1380-275-M070	-03	PTFE
FT1380-275-M090	-03 Synflex, -04, -05 PTFE	Synflex, PTFE
FT1380-275-M120	-04 Synflex, -06 PTFE	Synflex, PTFE
FT1382-275-M370	-16	Two-piece Winner
FT1382-275-M520	-20	6S
*FT1380-275-R5-04	-04	Truck and fuel 100R5
*FT1380-275-R5-05	-05	Truck and fuel 100R5
*FT1380-275-R5-06	-06	Truck and fuel 100R5
*FT1380-275-R5-08	-08	Truck and fuel 100R5
*FT1380-275-R5-10	-10	Truck and fuel 100R5
*FT1380-275-R5-12	-12	Truck and fuel 100R5
*FT1380-275-R5-16	-16	Truck and fuel 100R5
*FT1380-275-R5-20	-20	Truck and fuel 100R5

*Tooling above for use with Aeroquip hose and fittings

Crimp machines

T-420

General purpose crimp machine

The T-420 is a versatile machine ideal for your shop, factory, construction, and mine locations. Large capacity combined with lever-activated crimping gives you wide coverage and a quick and simple way to make factory-quality hose assemblies.



Tooling	Tooling capabilities			Tooling packages	
	1 wire braid 1A/Winner	2 wire braid 1A/Winner	4 wire spiral 4S	T420TP-1001	*T420TP-1002 (for Winner hose with 1A fittings)
Die cage part #					
ET425DC-4Z	-4	-4		X	X
ET425DC-5Z	-5	-5			
ET425DC-6Z	-6	-6		X	X
ET425DC-8Z	-8	-8		X	X
ET425DC-10Z	-10	-10			
ET425DC-12Z	-12	-12		X	X
ET425DC-16Z	-16	-16		X	X
ET425DC-20Z	-20	-20			X
ET425DC-4S6			-6		X
ET425DC-4S8			-8	X	X
ET425DC-4S10			-10		
ET425DC-4S12			-12	X	X
ET425DC-4S16			-16	X	X
ET425DC-4S20			-20	X	X

*T420TP-1001 includes spacer ring ET425SR-105A

*T420TP-1001 includes adapter ring ET425AR-14

*T420TP-1002 includes adapter ring ET425AR-14

*T420TP-1002 includes the following spacer rings—ET425SR-075A, ET425SR-030D, ET425SR-015A, ET425SR-060D, ET425SR-030A, ET425SR-045A, ET425SR-015D, ET425SR-060A, ET425SR-165A, ET425SR-105A, ET425SR-090A

NOTE: Visit the Danfoss PowerSource Crimp Specs tool at danfoss.com/crimp to find the tooling needed for all of the hoses and fittings you plan to crimp

Specifications

Dimensions:

22" high x 10" wide x 20-1/2" dee

Weight: 210 lbs

Capabilities

- **Braided hose:** -4 thru -20
- **Spiral hose:** -6 thru -20

Features

- Positive stop, economical
- Utilizes 2-piece collet assemblies
- Spacer rings control the crimp diameter
- Can be mounted on a bench, the C-40X cabinet, or the FF91042 crimper cart

Benefits

- Simple positive-stop crimp diameter control system for consistent crimping time after time with no operator adjustments required
- Versatile power source options
- Comes with high efficiency PTFE grease

T-420

General purpose crimp machine

T-420-1

Base T-420 machine

T-420-1CSA

Base T-420 machine, CSA approved

T-420-001

Contains T-420 crimper, 220v pump kit, T420TP-1001 tooling package

T-420-002

Contains T-420 crimper, 110v pump kit, T420TP-1001 tooling package

T-420-001CSA

Contains T-420 crimper, 220v pump kit, T420TP-1001 tooling package, CSA approved

T-420-002CSA

Contains T-420 crimper, 110v pump kit, T420TP-1001 tooling package, CSA approved

ET420-007

110 volt electric pump

ET420-007CSA

110 volt electric pump, CSA approved

ET420-008

220 volt electric pump

ET420-008CSA

220 volt electric pump, CSA approved

T-400-G

1.5 oz. tube high efficiency PTFE grease

FF91455

16 oz. can, high efficiency PTFE grease

FF91042

Crimper cart

For your convenience, we have created one to two optimized machine and tooling package options for each of the core crimp machines. **If the available options do not meet your needs, place your order for the desired machine, pump, and tooling separately,** following the chart below.

Tooling can also be ordered a la carte. Visit the Danfoss PowerSource Crimp Specs tool at danfoss.com/crimp to find the tooling needed for all of the hoses and fittings you plan to crimp.

T-420 ordering		
Select your base machine	Select your pump kit	Select your tooling package
T-420-1 Base T-420 machine	ET420-007 110v pump	T420TP-1001
T-420-1CSA Base T-420 machine, CSA approved	ET420-007CSA 110v pump, CSA approved	T420TP-1002 (for Winner hose with 1A fittings)
	ET420-008 220v pump	
	ET420-008CSA 220v pump, CSA approved	

Package with tooling
Order a machine package with tooling
T-420-001
T-420-002
T-420-001CSA
T-420-002CSA

Crimp machines

FT1390

General purpose crimp machine

The FT1390 crimp machine is a stand-alone machine and will crimp up to 2" braided, 2" four spiral, and 2" six spiral hydraulic hose assemblies. It boasts a programmable electronic keypad with 10 presets.

This keypad simplifies the hose crimping operation by allowing the machine operator to enter a predetermined setting for a specific hose type and size. The ten most often used crimp settings can be stored for one-touch retrieval. The machine will automatically crimp to the exact crimp diameter required for that hose type and size. The electronic crimp machine settings eliminate the need for spacers or shims in the crimping operation.



Tooling	Tooling capabilities				Tooling packages	
	1 wire braid 1A/Winner	2 wire braid 1A/Winner	4 wire spiral 4S	6 wire spiral 6S	ET4040TP-0007	ET4040TP-0008
Die cage part #						
FT1307-200-M150	-4	-4			X	
FT1307-200-M180	-6				X	
FT1307-200-M210	-8	-6	-6		X	
FT1307-200-M240	-10	-8			X	
FT1307-200-M280	-12	-10, -12†	-8, -10		X	
FT1307-200-M320		-12			X	
FT1307-200-M370	-16	-16			X	
FT1307-200-M420	-20		-16		X	
FT1307-200-M465	-20	-20			X	
FT1307-200-M520	-24				X	
FT1307-200-M550	-32††	-24			X	
FT1307-200-M690	-32	-32			X	
FT1209-200-82			-12		X	
FT1209-200-15		-24†				
FT1209-200-46		-20†				
*FT1390-200-14			-20			X
*FT1390-200-20			-24			X
*FT1390-200-23			-32			X
*FT1390-200-15				-20		
*FT1390-200-16				-24		
*FT1390-200-21		-40		-32		

*Die cages are hinged for ease of use when crimping large elbows

†Die cage used to crimp designated hose diameter with two piece Winner fitting

††Die cage used to crimp Winner hose with 1A fitting

NOTE: Visit the Danfoss PowerSource Crimp Specs tool at danfoss.com/crimp to find the tooling needed for all of the hoses and fittings you plan to crimp

Specifications

Dimensions:

49" high, 29" wide, 28" deep

Weight: 825 lbs

Capabilities

- **Braided hose:** -4 thru -32
- **Spiral hose:** -6 thru -32

Features

- Front-end loading design
- Electronic keypad control of crimp diameter
- Power return stroke, return limit control
- Drop-in tooling (crimp die cages)
- Backstop fitting locator
- Worklamp equipped
- Includes footswitch

Benefits

- Easy and quick to electronically enter crimp setting
- Can pre-program 10 most popular crimp settings
- Die cages easily slip in and out of machine
- Comes with high efficiency PTFE grease

FT1390

General purpose crimp machine

FT1390-115

Base machine with 115v pump

FT1390-115CSA

Base machine with 115v pump, CSA approved

FT1390-230

Base machine with 230v pump

FT1390-230CSA

Base machine with 230v pump, CSA approved

All pumps are included with machine purchase.

To review machine and pump package options please refer to the ordering options below.

T-400-G

1.5 oz. tube high efficiency PTFE grease

FF91455

16 oz. can, high efficiency PTFE grease

FT1390-115-12

Contains FT1390 crimper with 115v pump, and ET4040TP-0007 tooling package

FT1390-115-12CSA

Contains FT1390 crimper with 115v pump, and ET4040TP-0007 tooling package, CSA approved

For your convenience, we have created one to two optimized machine and tooling package options for each of the core crimp machines. **If the available options do not meet your needs, place your order for the desired machine, pump, and tooling separately,** following the chart below.

Tooling can also be ordered a la carte. Visit the Danfoss PowerSource Crimp Specs tool at danfoss.com/crimp to find the tooling needed for all of the hoses and fittings you plan to crimp.

FT1390 ordering		
Select your base machine	Pump included	Select your tooling package
FT1390-115 Base machine with 115v pump	FT1390-115 115v pump included	ET4040TP-0007
FT1390-115CSA Base machine with 115v pump, CSA approved	FT1390-115CSA 115v pump included	ET4040TP-0008
FT1390-230 Base machine with 230v pump	FT1390-230 230v pump included	
FT1390-230CSA Base machine with 230v pump, CSA approved	FT1390-230CSA 230v pump included	

Package with tooling

Order a machine package with tooling

FT1390-115-12

FT1390-115-12CSA

Crimp machines

FT1390

General purpose crimp machine (cont.)



Specialty crimp die cages

Tooling	Tooling capabilities	
Die cage part #	Hose size	Hose style
FT1209-200-14	-20	4S
FT1209-200-15	-20	6S
FT1209-200-16	-24	6S
FT1209-200-20	-24	4S
FT1209-200-21	-32	6S
FT1209-200-23	-32	4S
FT1390-200-21	-40	2B
FT1307-200-M070	-03 PTFE	PTFE
FT1307-200-M090	-03 Synflex, -04, -05 PTFE	Synflex, PTFE
FT1307-200-M120	-04 Synflex, -06 PTFE	Synflex, PTFE

NOTE: Additional dies and die cage assemblies also available. Refer to website or contact Danfoss

NOTE: FT1209-200-size & FT1390-200-size are for use with internal skive and 4S/6S fittings (SAE100R11 & SAE100R13 hose styles).

NOTE: FT1390-200-size dies cages are hinged to allow ease of use when crimping large elbows

FT1390

General purpose crimp machine (cont.)

Barrel crimp die cages		
Die cage part #	Hose size	Hose style
FT1307-200-R5-04	-04	Truck and fuel 100R5
FT1307-200-R5-05	-05	Truck and fuel 100R5
FT1307-200-R5-06	-06	Truck and fuel 100R5
FT1307-200-R5-08	-08	Truck and fuel 100R5
FT1307-200-R5-10	-10	Truck and fuel 100R5
FT1307-200-R5-12	-12	Truck and fuel 100R5
FT1307-200-R5-16	-16	Truck and fuel 100R5
FT1307-200-R5-20	-20	Truck and fuel 100R5
FT1307-200-R5-24	-24	Truck and fuel 100R5
FT1307-200-R5-32	-32	Truck and fuel 100R5
*FT1392-200-R5-24	-24	Truck and fuel 100R5
*FT1392-200-R5-32	-32	Truck and fuel 100R5

*Hinged die cage

NOTE: Tooling above for use with Aeroquip hose and fittings

Die cage repair kits	
Die cage part #	Order
FT1307-200-size	FT1307-2-9
FT1390-200-size	FT1390-2-9
FT1209-200-size	FT1209-2-9

Crimp machines

ET4001

General purpose crimp machine

The ET4001 is ideal for factory, high-performance machine operations, construction and mine locations. This machine offers the capabilities of crimping all of the crimp-style hose ends through -32. With this coverage, this heavy-duty crimper can handle all of your crimping needs.



Tooling	Tooling capabilities				Tooling packages			
	Die cage part #	1- wire braid 1A/Winner	2- wire braid 1A/Winner	4 wire spiral 4S	6 wire spiral 6S	*ET4001TP-1002 new placement package	*ET4001TP-1001 conversion package	*ET4001TP-1003 (for Winner hose with 1A fittings)
ET525DC-4Z	-4	-4				X	X	X
ET525DC-5Z	-5	-5						X
ET525DC-6Z	-6	-6				X	X	X
ET525DC-8Z	-8	-8				X	X	X
ET525DC-10Z	-10	-10						X
ET525DC-12Z	-12	-12				X	X	X
ET525DC-16Z	-16	-16				X	X	X
ET525DC-20Z	-20	-20						X
ET525DC-24Z	-24	-24						X
ET525DC-32Z	-32	-32						
ET525DC-4S6				-6				X
ET525DC-4S8				-8		X	X	X
ET525DC-4S10				-10				
ET525DC-4S12				-12		X	X	X
ET525DC-4S16				-16		X	X	X
ET525DC-4S20				-20		X	X	X
ET575DC-4S24				-24		X	X	X
ET575DC-4S32				-32		X	X	X
ET525DC-6S20					-20			
ET575DC-6S24					-24			
ET575DC-6S32					-32			

*ET4000AR-001 adapter ring included with base machine

*ET4001TP-1002 includes the following spacer rings -
ET575SR-135A, ET525SR-120A, ET525SR-180A,
ET525SR-225A, ET525SR-240A

*ET4001TP-1002 includes adapter ring ET4000AR-002

*ET4001TP-1001 includes the following spacer rings—ET575SR-135A, ET525SR-120A

*ET4001TP-1003 includes the following spacer rings—ET525SR-030A, ET575SR-120A, ET575SR-015A,
ET525SR-075A, ET525SR-015A, ET525SR-180A, ET525SR-090A, ET525SR-075D, ET525SR-045A,
ET525SR-240A, ET525SR-015D, ET525SR-060A, ET525SR-195A, ET525SR-120A, ET525SR-105A

NOTE: Visit the Danfoss PowerSource Crimp Specs tool at danfoss.com/crimp to find the tooling needed for all of the hoses and fittings you plan to crimp

Specifications

Dimensions:

29" high, 12" wide, 21" deep

Weight: 550 lbs

Capabilities

- **Braided Hose:** -4 thru -32
- **Spiral Hose:** -6 thru -32

Features

- Positive stop
- Features a two-stage pump providing high flow at low pressure for fast ram approach and low flow at high pressure for actual crimping
- Can be mounted on a bench, work table, or the FF91042 crimper cart

Benefits

- Ideal for factory, construction and mine locations
- Crimps up to 2" 6 wire spiral hose
- Comes with high efficiency PTFE grease

ET4001

General purpose crimp machine

- ET4001-004**
Base ET4001 machine with hose kit, pump, work lamp
- ET4001-004CSA**
Base ET4001 machine with hose kit, pump, work lamp, CSA approved

ET4001P-002
220v single phase electric pump

T-410-22
36" pump to press hose assembly

ET4001P-002CSA
220v single phase electric pump, CSA approved

ET4001-015
Contains ET4001 crimper, 220v pump kit, and ET4001TP-1002 tooling package

ET4001-015CSA
Contains ET4001 crimper, 220v pump kit, and ET4001TP-1002 tooling package, CSA approved

T-400-G
1.5 oz. tube high efficiency PTFE grease

FF91455
16 oz. can, high efficiency PTFE grease

ET4001C-0017
Magnetic work lamp

FF91042
Crimper cart

For your convenience, we have created one to two optimized machine and tooling package options for each of the core crimp machines. **If the available options do not meet your needs, place your order for the desired machine, pump, and tooling separately**, following the chart below.

Tooling can also be ordered a la carte. Visit the Danfoss PowerSource Crimp Specs tool at danfoss.com/crimp to find the tooling needed for all of the hoses and fittings you plan to crimp.

ET4001 ordering		
Select your base machine	Pump included	Select your tooling package
ET4001-004 Base ET4001 machine with hose kit, pump, work lamp	ET4001-004 220v pump included	ET4001TP-1002 New placement tooling package
ET4001-004CSA Base ET4001 machine with hose kit, pump, work lamp, CSA approved	ET4001-004CSA 220v pump included	ET4001TP-1003 (for Winner hose with 1A fittings)
		ET4001TP-1001 Conversion tooling package

Package with tooling
Order a machine package with tooling
ET4001-015
ET4001-015CSA

Crimp machines

ET5070

Industrial production crimp machine

The ET5070 is designed for high industrial production and comes pre-programmed with all of Danfoss' hose and hose fitting crimp specifications, crimp profile details, and machine settings in order to crimp to Danfoss' specifications. It crimps up to 2.5" spiral, 3" braided and 4" industrial in Danfoss core hose products as well as a wide variety of specialty hose.



Tooling packages: standard die

Standard die set part #	Die size		Die length		Minimum		Crimp range maximum	
	mm	in	mm	in	mm	in	mm	in
ET5040DC-M070S	7,0	0.276	82,0	3.23	7,0	0.28	9,0	0.35
ET5040DC-M090S	9,0	0.354	82,0	3.23	9,0	0.35	12,0	0.47
ET5040DC-M120S	12,0	0.472	82,0	3.23	12,0	0.47	15,0	0.59
*ET5040DC-M150S	15,0	0.590	82,0	3.23	15,0	0.59	18,0	0.71
*ET5040DC-M180S	18,0	0.709	82,0	3.23	18,0	0.71	21,0	0.83
*ET5040DC-M210S	21,0	0.827	82,0	3.23	21,0	0.83	24,0	0.95
*ET5040DC-M240S	24,0	0.945	82,0	3.23	24,0	0.95	28,0	1.10
*ET5040DC-M280S	28,0	1.102	82,0	3.23	28,0	1.10	32,0	1.26
ET5040DC-M320S†	32,0	1.259	82,0	3.23	32,0	1.26	37,0	1.46
ET5040DC-M355S	35,5	1.398	82,0	3.23	35,5	1.40	39,5	1.56
*ET5040DC-M370S	37,0	1.457	82,0	3.23	37,0	1.46	42,0	1.66
*ET5040DC-M420S	42,0	1.654	82,0	3.23	42,0	1.66	46,5	1.83
ET5040DC-M450S	45,0	1.772	82,0	3.23	45,0	1.77	50,0	1.97
*ET5040DC-M465S	46,5	1.831	82,0	3.23	46,5	1.83	52,0	2.05
ET5040DC-M505S	50,5	1.988	82,0	3.23	50,5	1.99	54,0	2.13
*ET5040DC-M520S	52,0	2.047	82,0	3.23	52,0	2.05	55,0	2.17
*ET5040DC-M550S	55,0	2.165	82,0	3.23	55,0	2.17	60,0	2.36
ET5040DC-M570S	57,0	2.244	82,0	3.23	57,0	2.24	64,0	2.52
ET5040DC-M590S	59,0	2.323	82,0	3.23	59,0	2.32	66,0	2.60
ET5040DC-M620S	62,0	2.441	82,0	3.23	62,0	2.44	70,0	2.76
*ET5040DC-M690S	69,0	2.717	82,0	3.23	69,0	2.72	73,0	2.87
ET5040DC-M720S	72,0	2.835	82,0	3.23	72,0	2.84	78,0	3.07
ET5040DC-M775S	77,5	3.051	82,0	3.23	77,5	3.05	85,5	3.37
ET5040DC-M790S	79,0	3.110	82,0	3.23	79,0	3.11	88,0	3.46

*Included in the ET5040C-0023 standard die kit

†Supplied with all ET5040 crimp machines and required for calibration
ET5040C-0001 adapter die required for all M series dies and comes standard in each KT machine package.

Specifications

Dimensions:

67" high x 24" wide x 48" deep

Weight: 1,851 lbs

(without mounting rack and dies)

Capabilities

- **Spiral hose:** up to 2.5" (DN51)
- **Braided hose:** up to 3" (DN80)
- **Industrial hose:** up to 6" (DN102)

Features

- 315 tons of crimp force
- Designed for high production
- Pre-programmed with Danfoss crimp specs and machine settings
- Crimps up to 2.5" spiral, 3" braided, 4" industrial in core products
- Crimps textile braid, wire braid, spiral hydraulic, thermoplastic, PTFE, air conditioning, and other industrial and specialty hose constructions

Benefits

- Ease of use and fast cycle times increase productivity
- Pre-loaded Danfoss crimp specs reduce errors and scrap
- Fast and safe crimp operation
- Grease free dies allow for much easier and cleaner die changeout and reduce chance for operator error due to not having to apply grease to dies and crimp ring
- Convenient die storage rack allows easy access to crimp dies and tooling

ET5070

Industrial production crimp machine tooling

Large bore die for the ET5070								
Standard die set part #	Die size		Die length		Minimum		Crimp range maximum	
	mm	in	mm	in	mm	in	mm	in
ET5040PBL-M740	74,0	2.913	118,0	4.65	74,0	2.92	83,0	3.26
ET5040PBL-M780	78,0	3.070	118,0	4.65	78,0	3.07	86,0	3.38
ET5040PBL-M840	84,0	3.307	118,0	4.65	84,0	3.31	92,0	3.62
ET5040PBL-M860	86,0	3.386	118,0	4.65	86,0	3.39	94,0	3.70
ET5040PBL-M900	90,0	3.543	118,0	4.65	90,0	3.55	99,0	3.89
ET5040PBL-M960	96,0	3.800	118,0	4.65	96,0	3.80	105,0	4.13
ET5040PBL-M1030	103,0	4.055	118,0	4.65	103,0	4.06	113,0	4.44
ET5040PBL-M1060	106,0	4.173	126,0	4.96	106,0	4.18	116,0	4.56
ET5040PBL-M1110	110,0	4.331	126,0	4.96	110,0	4.33	121,0	4.76
ET5040PBL-M1160	116,0	4.567	126,0	4.96	116,0	4.57	127,0	4.99
ET5040PBL-M1210	121,0	4.764	126,0	4.96	121,0	4.77	133,0	5.23
ET5040PBL-M1260	126,0	4.961	126,0	4.96	126,0	4.96	138,0	5.43
ET5040PBL-M1310	131,0	5.157	126,0	4.96	131,0	5.16	144,0	5.66

NOTE: Each set includes 8 individual dies

100R5 dies for the ET5070		
Die part #	Hose size	Hose style
ET5040DC-R5-04	-04	Truck and fuel 100R5
ET5040DC-R5-05	-05	Truck and fuel 100R5
ET5040DC-R5-06	-06	Truck and fuel 100R5
ET5040DC-R5-08	-08	Truck and fuel 100R5
ET5040DC-R5-10	-10	Truck and fuel 100R5
ET5040DC-R5-12	-12	Truck and fuel 100R5
ET5040DC-R5-16	-16	Truck and fuel 100R5
ET5040DC-R5-20	-20	Truck and fuel 100R5
ET5040DC-R5-24	-24	Truck and fuel 100R5
ET5040DC-R5-32	-32	Truck and fuel 100R5

ET5070

Industrial production crimp machine

ET5070-002-230/ET5070-002-230KT*

ET5070-002-380/ET5070-002-380KT*

ET5070-002-400/ET5070-002-400KT*

ET5070-002-420/ET5070-002-420KT*

ET5070-002-440/ET5070-002-440KT*

ET5070-002-460/ET5070-002-460KT*

ET5070-002-480/ET5070-002-480KT*

*All KT part numbers come with the machine, calibration tooling, die installation tool, standard die package, adapter die package, double foot pedal and machine mounted storage rack

Crimp machines

ET5070

Industrial production crimp machine



All pumps are included with machine purchase. To review machine and pump package options please refer to the following ordering options.

***ET5040C-0001†**

Adapter die package (Supplied with ET5070 crimp machines. Required for use with ET5040DC style dies and used to calibrate machine.)

***ET5040C-0004**

Die installation tool

ET5040C-0006

Automatic backstop

ET5040C-0007

Manual backstop

ET5050C-0009

Viewing mirror

*Components included in machine kit packages "KT"

†Calibration tooling (supplied with all ET5070 base machines)

Please note that ET5070 shares dies, crimp components, and some accessories with the ET5040 and ET5050

***ET5040C-0014**

Machine mounted die storage rack (includes insert holders)

ET5040C-0016

Table top die storage rack (includes insert holders)

***ET5040C-0019†**

Calibration tool (supplied with ET5070 crimp machines)

***ET5040C-0020**

Double pedal foot switch

***ET5040C-0023**

Includes 11 of the most popular standard ET5040DC style die sets

ET5040DC-M320St

32mm die set

ET5040DC-MXXX

Standard die sets

ET5040PBL-MXXX

Large bore industrial hose die sets

ET4001C-0017

Magnetic work lamp

Tooling can also be ordered a la carte. Visit the Danfoss PowerSource Crimp Specs tool at danfoss.com/crimp to find the tooling needed for all of the hoses and fittings you plan to crimp.

ET5070 ordering

Select a machine kit	Kit includes	Pump included
ET5070-002-230KT	ET5070-002-230 machine, calibration tooling, die installation tool, standard die package, adapter die package, double foot pedal and machine mounted storage rack	230v 3 phase pump included
ET5070-002-380KT	ET5070-002-380 machine, calibration tooling, die installation tool, standard die package, adapter die package, double foot pedal and machine mounted storage rack	380v 3 phase pump included
ET5070-002-400KT	ET5070-002-400 machine, calibration tooling, die installation tool, standard die package, adapter die package, double foot pedal and machine mounted storage rack	400v 3 phase pump included
ET5070-002-420KT	ET5070-002-420 machine, calibration tooling, die installation tool, standard die package, adapter die package, double foot pedal and machine mounted storage rack	420v 3 phase pump included
ET5070-002-440KT	ET5070-002-440 machine, calibration tooling, die installation tool, standard die package, adapter die package, double foot pedal and machine mounted storage rack	440v 3 phase pump included
ET5070-002-460KT	ET5070-002-460 machine, calibration tooling, die installation tool, standard die package, adapter die package, double foot pedal and machine mounted storage rack	460v 3 phase pump included
ET5070-002-480KT	ET5070-002-480 machine, calibration tooling, die installation tool, standard die package, adapter die package, double foot pedal and machine mounted storage rack	480v 3 phase pump included

Specialty tooling kit

The Danfoss tools listed are offered in kits for any given hose type, or collets and tools can be purchased individually by catalog number. Visit [www.aeroquip.com](#) to find the tooling needed for all of the hoses and fittings you plan to crimp.



T-400-66

069 'E' Series collet kit

This kit can be used with the following machines: T-420, ET4001

Spacer Rings not included in T-400-66 kit.

Kit includes one of each of the following

Part #	Description
T-400-54C	Collet – 3/16"
T-400-56C	Collet – 5/16"
T-400-57C	Collet – 13/32"
T-400-58C	Collet – 1/2"
T-400-59C	Collet – 5/8"
T-400-60C	Collet – 7/8"
T-400-61C	Collet – 1-1/8"

Repair and replacement items

General repair & replacement items

Part #	Description
T-400-G	1.5 oz. Tube high efficiency PTFE grease
FF91455	16 oz. Can, high efficiency PTFE grease

ET1000 repair & replacement items

Part #	Description
ET1000C-0001	Stand
ET1000C-0006	Pusher
ET1000AR-001	Adapter ring
ET1000C-0021	Wall mount bracket
ET1000C-0012	Pusher extension

ET4001 repair & replacement items

Part #	Description
ET4001C-0017	Gooseneck lamp, magnetic mount
T-410-1M	Micro switch
ET4000AR-001	Base adapter ring
ET4000AR-002	Base adapter ring
ET4000TP-0001	Locator bracket kit
ET4000TP-0002	Wear plate kit
ET4001C-0015	Shroud
120-00429	Screw, hex head (8)
FF91042	Cart for ET4001 or T-420

T-420 repair & replacement items

Part #	Description
T-420-1M	Micro-switch for T-420-1 press
T-420-28	Tool locator bracket
T-420-B	Tool locator bracket
W-EQCR-TE006-E	Shroud decal
T-420-H	Handle
T-420-L	Light bulb
T-420-LA	Light assembly
T-420-LS	Light switch
AN436777624684n-000101	Instructions for T-420-1
T-420-P	Pusher set (2) with wear plates and screws
T-420-S	Press shroud with decals
T-420-26	Insert – base plate
T-420-G	Linkage assembly
T-420-2R	Rack
T-420-2K	Pinion shaft assembly (incl'd T-420-2G, T-420-2R and T-420-2S)
T-420-2S	Replacement pinion gear shaft
140-06745	Pusher wear plates includes (1) left and (1) right
140-06748	Pusher wear plates screws (1)
FF91042	Cart for ET4001 or T-420

T-450/T-465 repair & replacement items

Part #	Description
T-450-D1	Spacer ring selector decal for nylon hose (H009, H209, H243, H435, and H436)
T-450-P	Pusher
T-450-Q	Quick disconnect coupling
T-450-K	Pusher and retainer plate repair kit: Includes: T-450-B Pusher bolt (1) T-450-R Retainer plate (1) T-450-S Retainer plate screw (2)
W-EQCR-TE011-E	Shroud decal

T-464 repair & replacement items

Part #	Description
AP432452437325en-000101	Instructions
T-460-SPR	Slide pull rod
T-460-16	Hose assembly
T-460-2	Hand pump
W-EQCR-TE009-E	Shroud decal
T-460-P	Pusher
T-460-SF	Slide flange
T-460-SP	Slide plate
T-460-SPK	Slide pull knob

T-466 repair & replacement items

Part #	Description
W-EQCR-TM008-E	Instructions
T-460-P	Pusher
T-460-SF	Slide flange
T-460-SP	Slide plate
W-EQCR-TE010-E	Shroud decal
140-06675	Air regulator kit
T-460-SPK	Slide pull knob
T-460-SPR	Slide pull rod
T-462-16	Hose assembly
T-462-V	Regulator only
T-462-2	Air/hydraulic pump

See pages 292 - 295 for replacement pumps.

Reference page 289 for specialty tooling and collet kits. For individual tooling items, such as collets, spacer rings, machine bowls, and adapter rings, visit [www.danfoss.com](#) or contact Danfoss.

Refer to the applicable machine operator's manuals for safety information.

Additional repair and replacement items are available. Refer to the owner's manual or contact Danfoss for information.

Repair and replacement items

T-480 portable crimp machine repair and replacement items

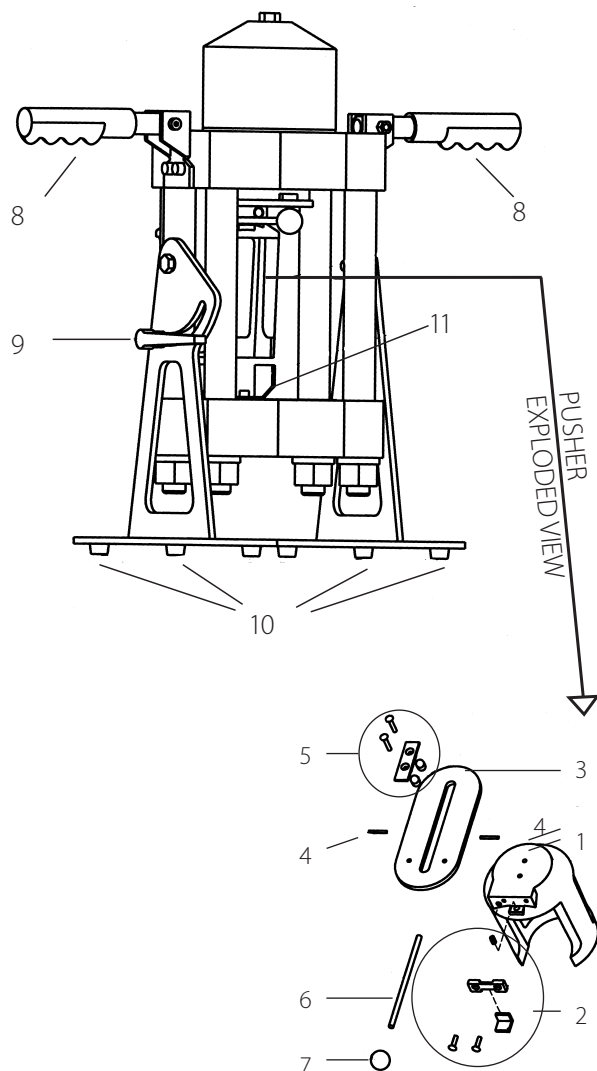

T-480 portable crimp machine repair & replacement items		
#	Part #	Description
1	T-480-P	Pusher
2	T-480-PSK	Pusher stop repair kit (Includes pusher clip, 2 machine screws, pusher stop & spring)
3	T-480-SP	Slider plate
4	140-05485-01	Roll pin
5	T-480-SFK	Slide flange kit (Includes slide flange, 2 bushings and 2 machine screws)
6	T-480-SPR	Slide pull rod
7	T-480-SPK	Slide pull knob
8	140-06601	Vinyl grip
9	T-480-TBK	Tilt bracket knob
10	140-06894	Foot pad
11	T-480-69	Tool locator bracket
#	T-480-16	10,000 PSI replacement hose assembly for 480-HP
#	T-480-17	10,000 PSI replacement hose assembly for T-480-TA and T-480-EP
#	T-480-18	10,000 PSI replacement hose assembly for 480-AH
#	140-06906	Hydraulic quick coupler used with the T-480-TA and T-480-EP system
#	T-480-3	Turbo air/hydraulic replacement pump for T-480-TA system
#	T-481-110	Electric replacement pump for T-480-EP system
#	T-480-2	Hand replacement pump for T-480-HP system
#	T-482-2	Air/hydraulic replacement pump for T-480-AH system
#	W-EQCR-TE012-E	Shroud decal
#	BC425482205281en-000101	Set-up and operating guide for T-480 system

Item not illustrated in parts breakdown.

T-400-1 crimp machine repair & replacement items	
Part #	Description
T-400-B	Pusher bolt
T-400-BB	Switch to interface T400-1 crimper to T421U pump or T-421U-110 pump. Upgraded solid state relay can be purchased through Lomar. Part number 140-06761-SS.
T-400-G	1.5 oz. Tube high efficiency * grease
T-400-K1	Seal replacement kit for T-400-1 press
W-EQCR-TD003-E	Shroud decal
T-400-M	Instructions for T-400-1
T-400-S	Replacement press shroud with decals
T-400-8	Die ring
T-400-13	Replacement** collet cage for T-400 "U" Series collets, 1/4" and 3/8" sizes only, and 229 "P" series collets, all sizes, with a "C" suffix.
T-400-14	Replacement** collet cage for T-400 "U" Series collets with a "C" suffix, 1/2" through 1" only
T-400-19	60" Hose assembly and fittings
T-400-90	Replacement** collet cage for T-400 "E", 069 "E", and "E" Series collets with a "C" suffix.
T-432-15	Pusher

** 2 required for each collet

Crimp machine power units

T-403-2

Hand pump

For use with T-400-1.



Dimensions :

7 high, 21" long, 4-3/4" wide

Weight :

9 lbs.

Operation pressure :

4000-4200 PSI

Reservoir capacity:

1 qt.

Outlet port size:

3/8"

NPT hydraulic oil:

Use Enerpac oil ONLY

Note:

For repair and replacement items for the following pumps please contact an Enerpac distributor at

www.enerpac.com: T-402-2, T-403-2, T-481-110 & T-482-2.

T-460-2

Hand pump

For use with T-450-1, T-460 and T-465.



Dimensions:

5-5/8" High, 13-1/4" long,
3-3/4" wide

Weight:

4-1/2 lbs.

Operation pressure :

0-10,000 PSI

Reservoir capacity :

20 cu in.

Relief valve setting :

10,000 PSI

Hydraulic oil:

Use Enerpac oil ONLY

Note:

For repair and replacement items for the following pumps please contact an Enerpac Distributor at

www.enerpac.com: T-402-2, T-403-2, T-433, T-460-2, T-462-2, T-480-2, T-480-3, T-481-110 & T-482-2.

T-480-2

Two-stage hand pump

For use with T-480-HP, ET1000.



Dimensions:

7-3/16" high x 21-1/64" long x 4-3/4" wide

Weight:

10 lbs.

Operation pressure :

0-10,000 PSI

Hydraulic oil :

Use Enerpac oil ONLY

Repair and replacement items for discontinued T-401-1 pump

Catalog #	Description
T-401-1BC	Breather cap for Fenner-Stone pumps
T-401-1S	Toggle switch
T-401-SVF	Shuttle valve for Fenner-Stone pump

Crimp machine power units

T-421U

Electric pump
(220 volt)

For use with T-400-1 and T-420-1.

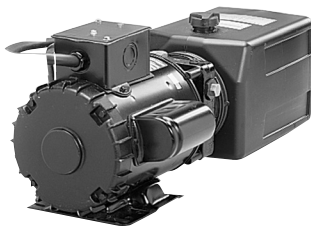

Dimensions: 7-1/2" high,
22" long, 10" wide

Weight : 75 lbs.

Operation pressure:
4000-4200 PSI

Reservoir capacity:
6 quarts

Outlet port size:
3/4"-16 Straight Thread

Motor: 1 H.P., 3450 R.P.M.,
220 volts, 60 cycle, single phase
At 50 Hertz, RPM = 2,850
At 60 Hertz, RPM = 3,450

T-421UCSA: CSA approved

Hydraulic oil*: ISO 32 hydraulic oil or (ATF)
automatic transmission fluid

Flow: 2.5 GPM @ 750 PSI,
0.5 GPM @ 4000 PSI

*For low temperature applications automatic transmission fluid can be substituted.

Replacement parts:

Catalog #	Description
140-06761	Relay for T-421U, T-441 and T-441 pumps only
T-421U-BC	Breather cap - twist lock
T-421-FP	220v 4 wire female electrical receptacle
T-401-1BC	Breather cap - threaded

Note: It is recommended that the electric pump be used on a 15 amp. fused circuit. Pump wired for 220 volts, single phase.

T-421U-110

Electric pump
(110 volt)

For use with T-400-1 and T-420-1.

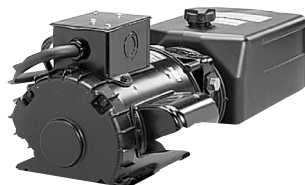

For dimensional data other than voltage information, refer to T-421U see above.

T-421U-110CSA
CSA approved

Note: It is recommended that the electric pump be used on an individual 30 amp. fused circuit. Pump wired for 110 volts, single phase.

Note: Upgraded solid state relay can be purchased through Lomar, part #: 140-06761-SS.

T-481-110

Electric pump
(110 volt)

For use with T-480-EP, ET1000 and ET1187.



Dimensions:
14-14" High, 9-5/8" long, 9-5/8" wide

Weight:
32 lbs.

Operation pressure:
0-10,000 psi

Hydraulic oil :
Use Enerpac oil ONLY

ET4001P-002

Electric pump
(220 volt)

For use with ET4001 press.

It features a two-stage pump providing high flow at low pressure for fast ram approach and low flow at high pressure for actual crimping.

Dimensions: 7½" high,
10" wide, 22" long

Weight 75 lbs.

Operation pressure
5,000 psi

Reservoir capacity 6 quarts

Outlet port size
¾-16 Straight thread O-Ring

Motor 1HP, 3450 RPM, 220 volts, 60 cycle, single phase

Hydraulic oil ISO 32
(SAE 10W)

Flow 2.6 GPM to 900 psi.
0.6 GPM above 900 psi

! The ET4001P-002 electric pump has the relief valve set at 5,000 psi. Damage to the press will result and the warranty may be voided if higher pressures are used. Requires individual 20 amp service breaker (220 v).

Crimp machine power units

T-441

Electric pump
(220 volt)

For use with T-440-1 and ET4000 only.

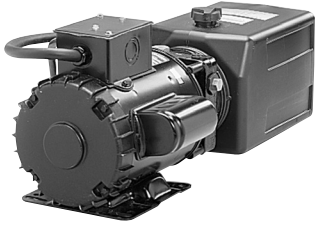

The T-441 power unit features a two-stage pump providing high flow at low pressure for a fast ram approach and low flow at high pressure for actual crimping.

Dimensions: 7-1/2" high, 22" long, 10" wide

Weight: 75 lbs.

Operation pressure: 5,000 PSI

Reservoir capacity: 6 quarts

Outlet port size : 3/4-16 Straight thread O-Ring

Motor: 1 H.P., 3450 R.P.M., 220 volts, 60 cycle, single phase

Hydraulic oil: ISO 32 hydraulic oil automatic transmission fluid

Flow: 2.5 GPM @ 750 PSI, 0.5 GPM @ 5000 PSI

Replacement parts:

Catalog #	Description
T-421U-BC	Breather cap
T-421-FP	220v 4 wire female electrical receptacle
140-06761	Relay for T-421U or T-421U-110 pumps

Note: T-441 pump is to be used with the T440-1 and ET4000 press only. When replacing the pump on a standard T-410 press (without the black switchbox on the side of the press) refer to the repair and replacement items on page 290.

T-402-2

Air/hydraulic pump

For use with T-400-1.



Dimensions : 5-1/4" high, 12-1/2" long, 5" wide

Weight: 18 lbs.

Operation pressure: 4000-4200 PSI

Reservoir capacity: 606 ml.

Hydraulic oil: Use Enerpac oil ONLY

Outlet port size: 3/8" NPT

Inlet (air) port size : 1/4" NPT

Inlet air pressure required : 60 to 120 PSI

Note: It is recommended that a filter, regulator, lubricator, and air pressure gauge be installed in the air line as close as possible to the pump. Filter, regulator, and lubricator units not included.

Some models have air port on right side.

T-482-2

Air/hydraulic pump

For use with T-480-AH, ET1000.

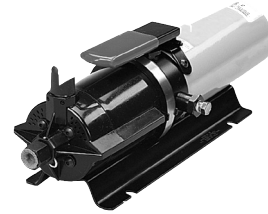

Dimensions: 5" High, 14-5/8" long, 5-5/8" wide

Weight: 12 lbs.

Operation pressure : 0-10,000 psi

Hydraulic oil: Use Enerpac oil ONLY

Crimp machine power units

T-462-2

Air/hydraulic pump

For use with T-462.



The T-462-2 power unit is a air/hydraulic pump designed for use with the T-462 portable system. Ideal if you have the availability of compressed air in your shop or in the field via a portable compressor.

Dimensions :
4" high, 13" long

Weight:
8 lbs.

Operation pressure:
0-10,000 PSI

Reservoir capacity :
10 cu in.

Relief valve setting :
10,000 PSI

Hydraulic oil :
Use Enerpac oil ONLY
Regulator to be set for
100-120 PSI inlet air

T-480-3

Turbo air/
hydraulic pump

For use with T-480-TA.



Dimensions:
8-1/4"High x 12-3/8" long x
8" wide

Weight:
16-1/2 lbs.

Operation pressure:
0-10,000 PSI

Hydraulic oil:
Use Enerpac oil ONLY

For repair and replacement items for the following pumps please contact an Enerpac Distributor at www.enerpac.com: T-402-2, T-403-2, T-460-2, T-462-2, T-480-2, T-480-3, T-481-110 & T-482-2.

T-421-FP

4-Prong female
electrical outlet



All 220v pumps are equipped with a four prong electrical outlet as illustrated.

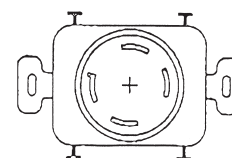

To obtain corresponding female wall receptacle order T-421-FP. For use with T-421U, T-441 and T-433 pumps.

Competitor conversion kits

T-420-GT

Gates PC707
conversion kit



The T-420-GT conversion kit is designed to allow the use of standard Danfoss tooling, hose, and hose ends in the Gates PC707 crimper. Everything is included to convert the crimper to accept Danfoss tooling. This kit gives the crimper capacity to crimp up to and including 1-1/4" I.D. 4 wire spiral hose factory-type hose assemblies.

- Shroud
- Adapter ring
- (2) Locater pins
- ET425SR-015D spacer ring
- Assembly Instructions

T-400-MK

Parker Minikrimp
conversion kit



The T-400-MK conversion kit is designed to allow the use of standard Danfoss tooling, hose, and hose ends in the Parker Minikrimp crimper. Everything is included to convert the crimper to accept Danfoss tooling. This kit gives the crimper capacity to crimp up to and including 5/8" I.D. 2 wire braided and 5/8" I.D. 4 wire spiral factory-type hose assemblies.

For installation, simply remove the pusher, snap ring, spring, and die cage separator from the crimper. Then, insert the adapter bowl and reinstall the pusher.

Capabilities and crimp specs are based on the Danfoss T-400 machine, but please note that a spacer ring is required for every crimp. The included ET313SR-FLAT-CLR spacer ring should be used.

- ET313AR-PK adapter bowl
- ET313SR-FLAT-CLR spacer ring
- Grease
- Vinyl wrap to cover shroud
- Danfoss decal
- Instruction sheet
- Caution decal
- Serial number decal
- Core hose crimp chart
- FF91761 Rust-oleum Gloss Charcoal Gray Spray Paint

T-420-KK

Parker Karrykrimp
conversion kit



The T-420-KK conversion kit is designed to allow the use of standard Danfoss tooling, hose, and hose ends in the Parker Karrykrimp 1 and Karrykrimp 2 crimpers. Everything is included to convert the crimper to accept Danfoss tooling. This kit gives the crimper capacity to crimp up to and including 1" I.D. braided hose and 5/8" I.D. 4 wire spiral hose for the Karrykrimp 1 and up to and including 1 1/4" I.D. 4 wire spiral hose for the Karrykrimp 2.

- ET425AR-PK
- (2) 2-1/2" roll pins
- ET1000C-0012 spacer ring
- Grease
- Vinyl wrap to cover shroud
- Danfoss decal
- Caution decal
- Serial number decal
- Core hose crimp chart
- Assembly instructions
- FF91761 Rust-oleum Gloss Charcoal Gray Spray Paint



Refer to the applicable machine operator's manuals for safety information.

T-420-PK

Parker Parkrimp
conversion kit



The T-420-PK conversion kit is designed to allow the use of standard Danfoss tooling, hose, and hose ends in the Parker Parkrimp 1 crimper. Everything is included to convert the crimper to accept Danfoss tooling. This kit gives the crimper capacity to crimp up to and including 1" I.D. braided hose and 5/8" I.D. 4 wire spiral hose.

- ET425AR-PK
- ET1000C-0012 Spacer
- Grease Tube
- Vinyl Wrap
- Danfoss Decal
- Instruction Sheet
- Caution Decal
- Serial Number Decal
- Core Hose Crimp Chart
- Spacer Dowels
- Right Cam Ramp
- Left Cam Ramp
- FF91761 Rust-oleum Gloss Charcoal Gray Spray Paint

Field attachable hose assembly machines

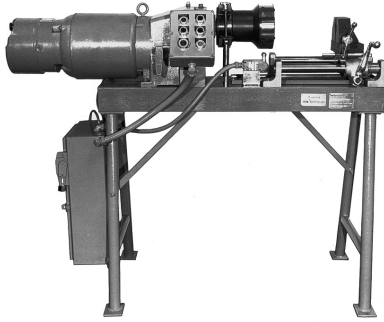
FT1028**Production field attachable hose assembly machine**

- Screw together fittings:
Fabric or wire braided hose up to
–32 four-spiral wire hose up to –24
- High volume production
- Ideal for 2 or 3 piece fittings
- 4 speed transmission; 90 rpm, 120 rpm,
210 rpm, 400 rpm
- Easy to operate
- Micrometer stop
- Electric brake
- U.L. listed
- 24" x 62" x 32", 550 lbs.

220/440V, 3 phase, 60 Hz.

FT1028–1–5 Base machine

FT1234**Drop-in socket holder**

Designed for use with the FT1028 assembly machine, the FT1234 drop-in socket holder prevents rotation of the socket during assembly and provides a back stop to ensure consistent location of the socket.

FT1234 drop-in socket holder			
Part #	Hex Size (inches)	Hose style	Socket part # and size
–100	9/16	2807–4	1206–4
–101	5/8	2807–5, 1503–4, FC300–04, FC350–04, FC321–04	1206–5, 1210–4
–102	11/16	2807–6, 1503–5, FC300–5, FC350–5, FC321–05	1206–6, 1210–5
–104	13/16	1503–6, 1509–4, FC300–6, FC350–6, FC321–06	1210–6, 4010–4
–105	7/8	2807–8	1206–8
–106	15/16	1503–8, FC300–08, FC350–08, FC321–08	1210–8
–200	1	2807–10	1206–10, FC3214–10
–201	1	1509–6, 1 508–6	4007–6, 4010–6, 4013–6
–202	1-1/8	1503–10, 1509–8, 1508–8, FC300–10, FC350–10, FC321–10	4013–8
–203	1-1/8	2807–12	1206–12
–204	1-1/4	1503–12, 1509–10, FC300–12, FC350–12	1210–12, 4010–10
–205	1-3/8	2807–16	1212–16, FC3214–16
–206	1-7/16	1503–16, FC300–16, FC350–16, FC321–16	1212–16
–207	1-1/2	1508–12	4007–12, 4013–12
–208	1-5/8		FC3214–20
–209	1-3/4	1503–20, FC300–20, FC350–20	1212–20

FT1033**Assembly mandrels**

Designed for use with the FT1028 assembly machine, the FT1033 assembly mandrels. Secured in the chuck they speed the volume production of Danfoss three piece field attachable hose fittings.

FT1033 assembly mandrels	
Part #	Fitting #
FT1033–1	FC9215–0404
FT1033–2	FC9215–0504
FT1033–3	FC9215–0808
FT1033–4	FC9215–0506
FT1033–5	FC9215–1010
FT1033–6	FC9210–0606
FT1033–7	FC9210–1212
FT1033–8	FC9211–0606
FT1033–9	FC9211–1212
FT1033–10	FC9211–1616
FT1033–11	FC9211–2020
FT1033–13	FC9212–0204 FC9212–0404 FC9216–0404
FT1033–14	FC9212–0406 FC9212–0606
FT1033–15	FC9212–0608 FC9212–0808
FT1033–16	FC9212–0810
FT1033–17	FC9212–1212
FT1033–18	FC9212–1616
FT1033–19	FC9212–2020
FT1033–21	411–4, 401–4
FT1033–22	411–5, 401–5
FT1033–23	401–6
FT1033–24	411–6
FT1033–25	411–8, 401–8
FT1033–26	411–10, 401–10
FT1033–27	401–12
FT1033–28	411–12
FT1033–29	406–16
FT1033–30	411–16
FT1033–31	406–20
FT1033–32	411–20
FT1033–33	406–24
FT1033–34	411–24
FT1033–35	406–32
FT1033–36	411–32
FT1033–37	412–2–4, 412–4–4
FT1033–38	412–4–5
FT1033–39	412–4–6
FT1033–40	412–6–12
FT1033–41	412–8–10, 412–12–10
FT1033–42	412–12–12

Field attachable fitting accessories

FT1220-10

Field attachable fitting assembly mandrels

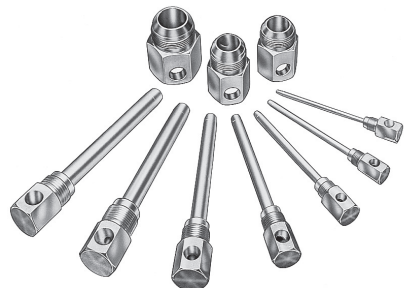

The FT1220-10 kit includes all assembly mandrels listed for -4 through -20 for the assembly of Danfoss 411, 401, and 406 field attachable hose fittings. Individual mandrels may also be ordered by using the part numbers to the right.

FT1220-10			
Use with fitting #s	SAE 37° (JIC)	SAE 45° PTT	30°
	411	401	406
Dash size			
-4	1582-4S	1582-4S	
-5	1582-5S	1582-5S	
-6	583-6S	1582-6S	
-8	1582-8S	1582-8S	
-10	1582-10S	1582-10S	
-12	583-12S	1582-12S	
-16	1563-16S		1561-16S
-20	1563-20S		1561-20S
-24	1563-24S		1561-24S
-32	1563-32S		

FT1220-10 kits			
Kit part #	Fitting part #	Thread types	Size range
1562 (not shown)	401, 406, 411, 412	SAE 45°, SAE 37° (JIC), PTT, NPTF	-4 to -32
1597 (not shown)	401, 412	SAE 45°, NPTF	-4 to -12
1598 (not shown)	411, 412	SAE 37° (JIC), NPTF	-4 to -32
1599 (not shown)	411, 412	SAE 37° (JIC), NPTF	-4 to -12
FT1220-10	401, 406, 411, 412	SAE 45°, SAE 37° (JIC), PTT, NPTF	-4 to -20

FT1038A

PTFE hose tool



Smooth bore PTFE Hose, -03, -04, -05, -06, -08, -10 and -12

- Small
- Hand held tool

FT1038A PTFE hose tool (-03 thru -12)

FT1038B PTFE hose tool (-16, -20)

F2015

SOCKETLESS fitting bench mounted assembly machine

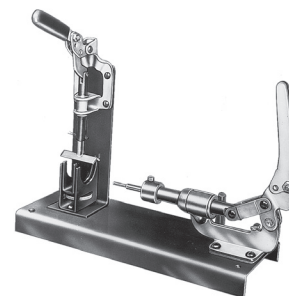

SOCKETLESS hose, all sizes

- Fast, hand assembly
- Bench mounted
- Hose is securely held
- Mandrels included

F2015 Complete machine

Field attachable fitting and hose cutting accessories

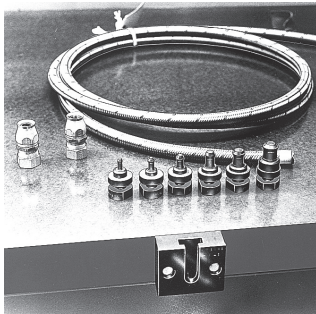
FT1081**PTFE hose assembly tool kit**

Smooth bore PTFE hose, -03, -04, -05, -06, -08, -10 and -12 hose. FT1090-3-10-4 and FT1090-3-10-5 are useful wire flare tools to use in conjunction with kit FT1081.

- Inexpensive
- Easy to use
- Seats PTFE tube against sleeve

FT1081 Complete tool kit

Includes:

FT1081-3-1	Mandrel holder
FT1081-3-2-3	Mandrel -3 hose
FT1081-3-2-4	Mandrel -4 hose
FT1081-3-3-5	Mandrel -5 hose
FT1081-3-4-6	Mandrel -6 hose
FT1081-3-5-8	Mandrel -8 hose
FT1081-3-6-10	Mandrel -10 hose
FT1081-3-7-12	Mandrel -12 hose
FT1081-16	Mandrel -16 hose
FT1081-20	Mandrel -20 hose

4523-04006**Hand-held hose cutter**

Handy tool for cutting Danfoss Synflex hose 1/8-inch to 1/2-inch in diameter. Blades are replaceable. Vinyl cushioned grips

Part #: 4523-04005

4523-04007**Bench top cutter**

The 4523-04007 bench top cutter is ideal for production of thermoplastic and other fabric reinforced hose style assemblies.

4574-01000**Twin-line hose separation tool**

Designed for separating Twin-Line hose

Part #: 4574-02000

FT1258**Bench mount cut off tool**

The FT1258 bench mounted cut off tool is ideal for production of thermoplastic and other fabric reinforced hose style assemblies.

Part #: FT1258-2-2

222070**Assembly lube, one pint**

Specially compounded petroleum based hose assembly lubricant.

Part #: 222070-8

4573-00000

Multi-line hose separation tool



Designed for separation of tri-, quad- and five-line hose

Part #: 4523-04005

T-191

Plastic tube and hose cutter

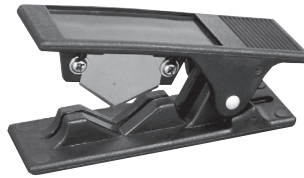

Only 2-7/8" long, the versatile T-191 offers quick and clean square cuts on 1/16" to 1/2" O.D. plastic tubing and non-wire reinforced hose. The T-191 can be either bench or wall mounted and offers the safety of closing automatically when not in use.

Part #: T-191B
(one per package)

FT1341

Thread measuring kit



Measuring tube and pipe fitting threads can be a most difficult task if not completely understood. Tools needed include a thread pitch gauge, calipers and seat angle gauges. To aid you, Danfoss has a kit to fit your needs; the FT1341 thread measuring kit.

- Thread pitch gauge (Imperial and metric)
- Inside/outside caliper (inches and millimeters)
- 2 seat angle gauges (37°/45° and a 12°/30°)
- How to identify fluid ports and connectors bulletin
- Carrying case for easy and convenient storage

Weight: .5 lb.

Aeroquip by Danfoss

Hose prep



Hose saws

ET9000, ET9100, ET9200 & ET9300 series

Hose saws

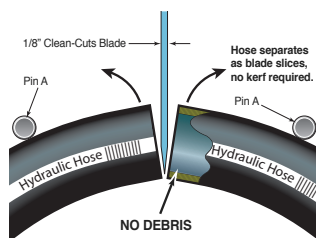
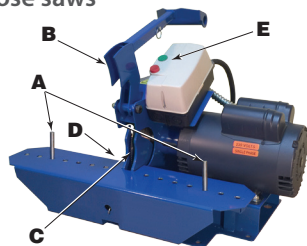

ET9100/200/300 hydraulic hose cutting system is break-through technology using a toothed blade, cutting with the backs of each tooth, so the blade does not take a kerf. The saw bends the hose into the blade spreading the cut edges to avoid burning and smoking.

With the ET9100/200/300 hydraulic hose saws the hose is positioned across two pins (A) and moved into the blade (C) by a feed foot (B) using a pulldown handle for better leverage on heavy hose. The feed motion causes the

hose to stretch at the point of contact with the blade, allowing it to separate as it is cut (see image at right). This separation allows the hose to pass clear of the saw blade with NO friction, NO heating and NO DEBRIS! A vacuum hose (not shown) is attached to a vacuum port (D) to remove any tiny amount of debris or smoke during cutting. Improved safety using a 110V on/off switch (E) with a magnetic contactor. When power is lost, the saw will not turn back on independently. Comes with advanced scalloped blade.

WARNING

The user must exercise extreme care when operating any Danfoss assembly equipment with powered moving components. Safety glasses must be worn at all times when using any Danfoss assembly equipment.

Read and understand the owners and operators manual before attempting to operate any equipment.

Danfoss personnel are available to answer any questions, please call:

Danfoss,
14615 Lone Oak Road,
Eden Prairie, MN 55344,
952-937-9800.

Danfoss assembly equipment is designed to be used only with Danfoss hose and Danfoss hose fittings.

ET9000 series



ET9000 series saw

Model	Motor	4-1/2" inch Blade	Cutting capacity
ET9000-45-110	1 HP, 115 VAC (1 Phase), 60 Cycle, 7.5 amp, 11,000 RPM	4-1/2" OD x 0.070 THK x 5/8" arbor	3/4" ID x 2 wire braid hydraulic hose

* Requires 15 Amp Circuit †Canadian Standards Association Rated

* ET9000 saws ship with micro-slotted blade.

ET9000 series saw blade

Model	Type	Blade	Cutting capacity
ET9000C-45-MS	Micro-slotted blade	4-1/2" OD x 0.070 THK x 5/8" arbor	3/4" ID x 2 wire braid hydraulic hose

ET9100 series

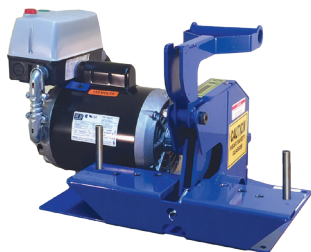

ET9100 series saws			
Model	Motor	7 inch Blade	Cutting capacity
ET9100-07-110	1-1/2 HP, 110 VAC (1 Phase), 60 Cycle, 17** Amp, 3,430 RPM	7" OD x .093 THK x 3/4" arbor	1-1/4" ID x 4 wire hydraulic hose
ET9100-07-110CSA†	1-1/2 HP, 110 VAC (1 Phase), 60 Cycle, 17** Amp, 3,430 RPM	7" OD x .093 THK x 3/4" arbor	1-1/4" ID x 4 wire hydraulic hose
ET9100-07-22060	2 HP, 220 VAC (1 Phase), 60 Cycle, 11* Amp, 3,430 RPM	7" OD x .093 THK x 3/4" arbor	1-1/4" ID x 4 wire hydraulic hose
ET9100-07-22050	2 HP, 220 VAC (1 Phase), 50 Cycle, 11* Amp, 2,865 RPM	7" OD x .093 THK x 3/4" arbor	1-1/4" ID x 4 wire hydraulic hose

* Requires 15 Amp Circuit ** Requires 20 Amp Circuit †Canadian Standards Association Rated

* ET9100 saws ship with advanced scalloped blade.

* Requires 15 Amp Circuit ** Requires 20 Amp Circuit †Canadian Standards Association Rated

* ET9000 saws ship with micro-slotted blade.

ET9100 series saw blades			
Model	Type	Blade	Cutting capacity
ET9100C-07-AS	Advanced scalloped blade	7" OD x .093 THK x 3/4" arbor	1-1/4" ID x 4 wire hydraulic hose
ET9100C-07-MS	Micro-slotted blade	7" OD x .093 THK x 3/4" arbor	1-1/4" ID x 4 wire hydraulic hose
ET9100C-07-SM	Smooth blade	7" OD x .093 THK x 3/4" arbor	1-1/4" ID x 4 wire hydraulic hose
ET9100C-07-SC	Scalloped blade	7" OD x .093 THK x 3/4" arbor	1-1/4" ID x 4 wire hydraulic hose
ET9100C-07-SL	Slotted blade	7" OD x .093 THK x 3/4" arbor	1-1/4" ID x 4 wire hydraulic hose

Hose saws

ET9200 series



ET9200 series saws			
Model	Motor	10 inch Blade	Cutting capacity
ET9200-10-220	5 HP, 220 VAC (1 Phase), 60 Cycle, 21 Amp, 3,490 RPM	10" OD x .125 THK x 40 mm	2" ID x 6 wire hydraulic hose ‡
ET9200-10-22050	3 HP, 220 VAC (1 Phase), 50 Cycle, 4 Amp, 2,865 RPM	10" OD x .125 THK x 40 mm	2" ID x 6 wire hydraulic hose ‡
ET9200-10-220 CSA †	5 HP, 220 VAC (1 Phase), 60 Cycle, 21 Amp, 3,490 RPM	10" OD x .125 THK x 40 mm	2" ID x 6 wire hydraulic hose ‡
ET9200-10-220-3	3 HP, 220 VAC (3 Phase), 60 Cycle, 11* Amp, 3,490 RPM	10" OD x .125 THK x 40 mm	2" ID x 6 wire hydraulic hose ‡
ET9200-10-220-3 CSA †	3 HP, 220 VAC (3 Phase), 60 Cycle, 11* Amp, 3,490 RPM	10" OD x .125 THK x 40 mm	2" ID x 6 wire hydraulic hose ‡
ET9200-10-440-3	3 HP, 440 VAC (3 Phase), 60 Cycle, 4 Amp, 3,490 RPM	10" OD x .125 THK x 40 mm	2" ID x 6 wire hydraulic hose ‡
ET9200-10-12V	4 HP, 12 VDC, 10,000 RPM	10" OD x .125 THK x 40 mm	2" ID x 4 wire hydraulic hose
ET9200-10-24V	4 HP, 24 VDC, 10,000 RPM	10" OD x .125 THK x 40 mm	2" ID x 4 wire multi-spiral hydraulic hose

* Requires 15 Amp Circuit ** Requires 20 Amp Circuit * ET9200 saws ship with advanced scalloped blade.
 †Canadian Standards Association Rated ‡ Diamond Blade Recommended for Frequent 6 Wire Cutting

ET9200 series saw blades			
Model	Type	10 inch Blade	Cutting capacity
ET9200C-10-AS	Advanced scalloped blade	10" OD x .125 THK X 40 mm arbor	2" ID x 6 wire hydraulic hose ‡
ET9200C-10-MS	Micro-slotted blade	10" OD x .125 THK X 40 mm arbor	2" ID x 6 wire hydraulic hose ‡
ET9200C-10-D	Diamond blade	10" OD x .125 THK X 40 mm arbor	2" ID x 6 wire hydraulic hose ‡
ET9200C-10-SM	Smooth blade	10" OD x .125 THK X 40 mm arbor	2" ID x 6 wire hydraulic hose ‡
ET9200C-10-SC	Scalloped blade	10" OD x .125 THK X 40 mm arbor	2" ID x 6 wire hydraulic hose ‡
ET9200C-10-SL	Slotted blade	10" OD x .125 THK X 40 mm arbor	2" ID x 6 wire hydraulic hose ‡

ET9300 series



ET9300 series saws			
Model	Motor	14 inch Blade	Cutting capacity
ET9300-14-220	5 HP, 220 VAC (1 Phase), 60 Cycle, 21 Amp, 3,490 RPM	14" OD x .160 THK X 40 mm	2" ID x 6 wire hydraulic hose ‡ and 5" OD spiral wound hose
ET9300-14-22050	3 HP, 220 VAC (1 Phase), 50 Cycle, 11* amp, 3,490 RPM	14" OD x .160 THK X 40 mm	2" ID x 6 wire hydraulic hose ‡ and 5" OD spiral wound hose
ET9300-14-220-3	3 HP, 220 VAC (3 Phase), 60 Cycle, 11* Amp, 3,490 RPM	14" OD x .160 THK X 40 mm	2" ID x 6 wire hydraulic hose ‡ and 5" OD spiral wound hose
ET9300-14-440-3	3 HP, 440 VAC (3 Phase), 60 Cycle, 4 Amp, 3,490 RPM	14" OD x .160 THK X 40 mm	2" ID x 6 wire hydraulic hose ‡ And 5" OD spiral wound hose
ET9300-14-220-3 CSA †	3 HP, 220 VAC (3 Phase), 60 Cycle, 11* Amp, 3,490 RPM	14" OD x .160 THK X 40 mm	2" ID x 6 wire hydraulic hose ‡ and 5" OD spiral wound hose

* Requires 15 Amp Circuit ** Requires 20 Amp Circuit * ET9300 saws ship with advanced scalloped blade.

† Canadian Standards Association Rated ‡ Diamond Blade Recommended for Frequent 6 Wire Cutting

ET9300 series saw blades			
Model	Type	Blade size	Cutting capacity
ET9300C-14-AS	Advanced scalloped blade	14" OD x .160 THK X 40 mm arbor	2" ID x 6 wire hydraulic hose 5" OD spiral wound hose
ET9300C-14-MS	Micro-slotted blade	14" OD x .160 THK X 40 mm arbor	2" ID x 6 wire hydraulic hose 5" OD spiral wound hose
ET9300C-14-D	Diamond blade	14" OD x .160 THK X 40 mm arbor	2" ID x 6 wire hydraulic hose 5" OD spiral wound hose
ET9300C-14-SM	Smooth blade	14" OD x .160 THK X 40 mm arbor	2" ID x 6 wire hydraulic hose 5" OD spiral wound hose
ET9300C-14-SC	Scalloped blade	14" OD x .160 THK X 40 mm arbor	2" ID x 6 wire hydraulic hose 5" OD spiral wound hose
ET9300C-14-SL	Slotted blade	14" OD x .160 THK X 40 mm arbor	2" ID x 6 wire hydraulic hose 5" OD spiral wound hose

Hose saw blades

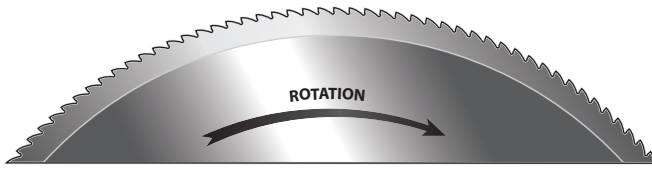

Features advanced performance scalloped knife technology for cutting hydraulic spiral hose and wire helix hose resulting in cleaner cuts, faster cuts, no smoke, and longer blade life. Available in 6" to 14" sizes to fit Aeroquip®, Clean-Cuts™, Custom Crimp®, Gates®, Goodyear®, Imperial Eastman®, Parker®, Stratoflex®, Toledo®, and Weatherhead® saws.

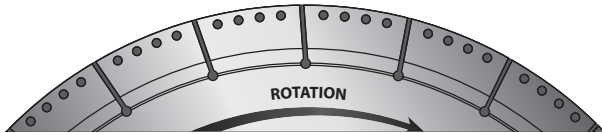

Exclusively designed for cutting heavy 4 and 6 wire hydraulic hoses. This diamond grinding technology cuts down by 60% the debris while cutting heavy hoses very quickly as opposed to using abrasive wheels. You will get a fantastic finish and make 5 – 10 second cuts in 2" hose.



Smooth edge knife designed for the best finish when cutting light duty hoses like single wire braid, textile reinforced, poly or nylon reinforced, and Teflon® fluoropolymer® resin hoses.

Available in sizes 7"-14" to fit Aeroquip®, Clean-Cuts™, Custom Crimp®, Gates®, Goodyear®, Hydroscand®, Imperial Eastman®, O+P®, Parker®, Savage Stone®, Stratoflex®, Toledo®, and Weatherhead®.

Teflon is a trademark of The Chemours Company FC, LLC used under license by Danfoss.

Advanced scalloped blade				
Model	Diameter	Thickness	Arbor	Danfoss saw
ET9500C-06-AS	6"	0.093"	5/8"	-
ET9500C-07-AS	7"	0.093"	5/8"	-
ET9100C-07-AS	7"	0.093"	3/4"	ET9100
ET9500C-08-AS	8"	0.093"	5/8"	-
ET9500C-10-AS	10"	0.093"	3/4"	-
ET9500C-10-1-AS	10"	0.125"	1"	-
ET9200C-10-AS	10"	0.125"	40mm	ET9200
ET9500C-12-AS	12"	0.125"	1"	-
ET9500C-14-AS	14"	0.125"	1"	-
ET9300C-14-AS	14"	0.160"	40mm	ET9300

Diamond hydraulic hose blade				
Model	Diameter	Thickness	Arbor	Danfoss saw
ET9200C-10-D	10"	0.125"	40mm	ET9200
ET9300C-14-D	14"	0.160"	40mm	ET9300

Smooth beveled edge hydraulic hose blade				
Model	Diameter	Thickness	Arbor	Danfoss saw
ET9500C-07-SM	7"	0.093"	5/8"	-
ET9100C-07-SM	7"	0.093"	3/4"	ET9100
ET9500C-08-SM	8"	0.093"	5/8"	-
ET9500C-10-SM	10"	0.062"	5/8"	-
ET9500C-10-1-SM	10"	0.093"	3/4"	-
ET9200-10-1-SM	10"	0.093"	40mm	ET9200
ET9500C-10-2-SM	10"	0.125"	1"	-
ET9200C-10-SM	10"	0.125"	40mm	-
ET9500C-12-SM	12"	0.093"	1"	-
ET9500C-12-1-SM	12"	0.125"	1"	-
ET9500C-14-SM	14"	0.125"	1"	-
ET9300C-14-SM	14"	0.160"	40mm	ET9300
ET9500C-16-SM	16"	0.160"	1"	-
ET9500C-18-SM	18"	0.160"	1"	-
ET9500C-20-SM	20"	0.160"	1"	-
ET9500C-22-SM	22"	0.160"	1"	-
ET9500C-24-SM	24"	0.160"	1"	-
ET9500C-26-SM	26"	0.160"	1"	-

Hose saw blades

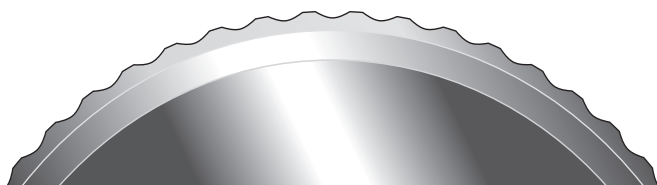

Notched scalloped knives are designed for rough duty cutting on spiral hose up to 6 wire.

Available in sizes 7"-14" to fit Aeroquip®, Clean-Cuts™, Custom Crimp®, Gates®, Goodyear®, Hydros cand®, Imperial Eastman®, O+P®, Parker®, Savage®, Stone®, Stratoflex®, Toledo®, and Weatherhead®.

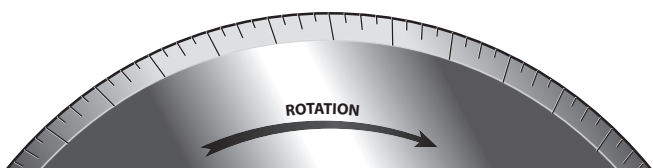

Features "new" micro-slotted smooth edge knife technology combining the better finishes of a double bevel knife with the more aggressive performance of a slotted knife. This is our most universal knife grind and will give you two times longer blade life than smooth edge knives. Used for cutting spiral hose, industrial hose, Teflon, PTFE, Kevlar, and metal hose.

Available in 6" to 14" sizes to fit Aeroquip®, Clean-Cuts™, Custom Crimp®, Gates®, Goodyear®, Imperial Eastman®, Parker®, Stratoflex®, Toledo®, and Weatherhead® saws.

Also available in 16" to 26" sizes to fit Hydros cand®, Finn Power®, Marken®, O+P®, Savage®, Stone®, Techmaflex® and Uniflex® saws.



Designed for cutting 4 to 6 wire spiral hoses, this high performance heavy duty slotted knife reduces pinching by skiving the sides of the hose while cutting.

Available in 7" to 14" sizes to fit Aeroquip®, Clean-Cuts™, Custom Crimp®, Gates®, Goodyear®, Imperial Eastman®, Parker®, Stratoflex®, Toledo®, and Weatherhead® saws.

Available in sizes 16" to 36" to fit on Finn Power®, Hydros cand®, Marken®, O+P®, Savage®, Stone®, Stratoflex®, Techmaflex® and Uniflex® saws.

Notched scalloped hydraulic hose blade

Model	Diameter	Thickness	Arbor	Danfoss saw
ET9500C-07-SC	7"	0.093"	5/8"	-
ET9100C-07-SC	7"	0.093"	3/4"	ET9100
ET9500C-08-SC	8"	0.093"	5/8"	-
ET9500C-10-SC	10"	0.093"	3/4"	-
ET9500C-10-1-SC	10"	0.125"	1"	-
ET9200C-10-SC	10"	0.125"	40mm	ET9200
ET9500C-12-SC	12"	0.125"	1"	-
ET9500C-14-SC	14"	0.125"	1"	-

Micro-slotted smooth edge hydraulic hose blade

Model	Diameter	Thickness	Arbor	Danfoss saw
ET9000C-45-MS	4.5"	0.070"	5/8"	ET9000
ET9500C-06-MS	6"	0.093"	5/8"	-
ET9500C-07-MS	7"	0.093"	5/8"	-
ET9100C-07-MS	7"	0.093"	3/4"	ET9100
ET9500C-08-MS	8"	0.093"	5/8"	-
ET9500C-10-MS	10"	0.062"	5/8"	-
ET9500C-10-1-MS	10"	0.093"	3/4"	-
ET9200C-10-1-MS	10"	0.093"	40mm	ET9200
ET9500C-10-2-MS	10"	0.125"	1"	-
ET9200C-10-MS	10"	0.125"	40mm	ET9200
ET9500C-12-MS	12"	0.093"	1"	-
ET9500C-12-1-MS	12"	0.125"	1"	-
ET9500C-14-MS	14"	0.125"	1"	-
ET9300C-14-MS	14"	0.160"	40mm	ET9300
ET9500C-16-MS	16"	0.160"	1"	-
ET9500C-18-MS	18"	0.160"	1"	-
ET9500C-20-MS	20"	0.160"	1"	-
ET9500C-22-MS	22"	0.160"	1"	-
ET9500C-24-MS	24"	0.160"	1"	-
ET9500C-26-MS	26"	0.160"	1"	-

Slotted smooth hydraulic hose blade

Model	Diameter	Thickness	Arbor	Danfoss saw
ET9500C-07-SL	7"	0.093"	5/8"	-
ET9100C-07-SL	7"	0.093"	3/4"	ET9100
ET9500C-08-SL	8"	0.093"	5/8"	-
ET9500C-10-SL	10"	0.062"	5/8"	-
ET9500C-10-1-SL	10"	0.093"	3/4"	-
ET9200C-10-1-SL	10"	0.093"	40mm	ET9200
ET9500C-10-2-SL	10"	0.125"	3/4"	-
ET9500C-10-3-SL	10"	0.125"	1"	-
ET9200C-10-SL	10"	0.125"	40mm	ET9200
ET9500C-12-SL	12"	0.093"	1"	-
ET9500C-12-1-SL	14"	0.125"	1"	-
ET9500C-14-SL	14"	0.125"	1"	-
ET9300C-14-SL	14"	0.160"	40mm	ET9300
ET9500C-16-SL	16"	0.160"	1"	-
ET9500C-18-SL	18"	0.160"	1"	-
ET9500C-20-SL	20"	0.160"	1"	-
ET9500C-20-1-SL	20"	0.160"	40mm	-
ET9500C-21-SL	21"	0.160"	38mm	-
ET9500C-22-SL	22"	0.160"	50mm	-
ET9500C-24-SL	24"	0.160"	1"	-
ET9500C-26-SL	26"	0.160"	1"	-

Skiving tools

FT1229-size Silver chromate mandrel

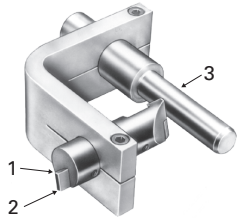

- 1 FT1229-2-3 blade holder
- 2 FT1229-3-4 skive blade
- 3 FT1229-100-size

FT1230-size Yellow chromate mandrel

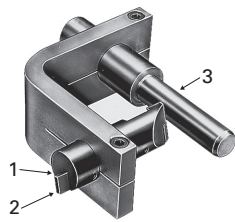

- 1 FT1229-2-3 blade holder
- 2 FT1229-3-4 skive blade
- 3 FT1230-100-size

FT1231-size Black oxide mandrel

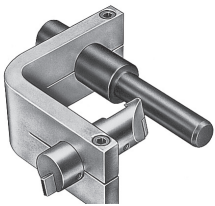

Mandrels						
Hose size	Field attachable fittings		Crimp fittings		Crimp internal skive fittings	
	FT1229	Skive length	FT1230	Skive length	FT1231	Skive Length
-03			-3	0.45		
-04	-4	0.91	-4	0.76		
-05			-5	0.76		
-06	-6	1.15 1.23 1.30	-6	0.90		
-08	-8	1.25	-8	1.04	-8	1.34
-10	-10	1.25	-10	1.11		
-12	-12 -12B ³	1.40 2.40	-12 ¹	1.21 1.31	-12	1.40
-16	-16 -16B ³	1.65 2.30	-16 -20 ¹	1.30	-16	1.85
-20	-20 -20A ⁴ -20B ³	2.09 2.60 2.75		1.66 1.52 1.88	-20	2.05
-24	-24 -24B ⁵	1.95 2.60	-24 ¹	1.74 1.64 2.18	-24	2.05
-32	-32 ²	2.05			-32	2.30

1 Adjustable tool. 2 FT1229-32 tool is used for field attachable and crimp fittings.
 3 For FC606. 4 For GH493. 5 For GH493 and FC254.

For skiving rubber covered wire reinforced hoses
 When selecting skive tools, refer to Danfoss document
 for proper skive length of hose sizes.

FT1240

Internal skive tool



* When tooling begins to wear, contact customer service for information on how to exchange for sharpened tooling.

Internal skive tool

Internal skive tool	FC254	FC323 FC324 FC273	FC325	FC606
FT1240-150-8	-08			
FT1240-100-12		-12	-12	
FT1240-150-12	-12			
FT1240-150-16	-16	-16	-16	-16
FT1240-100-20		-20	-20	
FT1240-150-20	-20			-20
FT1240-100-24		-24	-24	
FT1240-150-24	-24			
FT1240-100-32		-32	-32	
FT1240-150-32	-32			

FT1279

Auger attachment

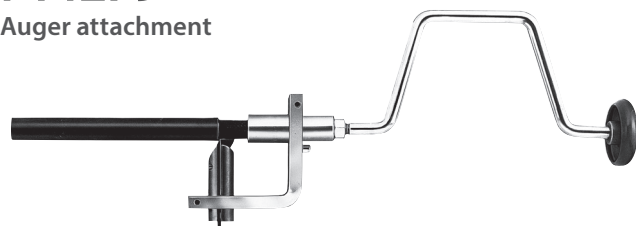

The FT1279 auger attachment permits efficient skiving of rubber covered wire reinforced hose.

Designed for use with FT1229, FT1230 and FT1231 skiving tools, the FT1279 auger attachment promotes quick completion of hand skiving operations.

Hose proof test stands

FT1312

Hose proof test stand



Assemblies up to 2" I.D.,
6 spiral wire

- Designed to use tap water, eliminating the need for a special test fluid
- Compact power unit is air driven
- Air regulator and gauge provide easy pressure adjustment and monitoring
- Tough transparent Lexan* lid
- 79" x 36" x 53", 550 lbs

The power unit of the FT1312 tester is a compact, economical air driven hydraulic pump. It will provide sufficient hydraulic pressure to proof test any Aeroquip hose assembly, up to 22,000 psi

*Lexan is a General Electric trademark.

FT1261

Hose proof test stand



Assemblies up to 2" I.D.,
6 spiral wire in
50 ft. coil lengths

- Designed to use tap water, eliminating the need for a special test fluid
- Air regulator and gauge provide easy pressure adjustment and monitoring
- Tough transparent Lexan* lid
- 96" x 84" x 54", 800 lbs

The power unit of the FT1261 tester is a compact, economical air driven hydraulic pump. It will provide sufficient hydraulic pressure to proof test any Aeroquip hose assembly, up to 22,000 psi

*Lexan is a General Electric trademark.

FT1312 and FT1261 Standard adapter selection chart

Hose fitting* style and size	Fitting adapter part #	Pressure port adapter part #	Plug or cap part #
SAE 37°(JIC) swivel			
-4	2027-8-4S	**	900599-4
-5	2021-6-5S	2081-12-6S	900599-5
-6	2027-8-6S	**	900599-6
-8	2027-8-8S	**	900599-8
-10	2027-10-08S	**	900599-10
-12	2027-08-12S	**	900599-12
-16	2021-12-16S	**	900599-16
-20	2021-16-20S	2040-12-16S	900599-20
-24	2021-16-24S	2040-12-16S	900599-24
-32	2021-16-32S	2040-12-16S	900599-32
SAE 45° swivel			
-4	2000-06-4B	2081-12-6S	900599-4
-5	2000-06-5B	2081-12-6S	900599-5
-6	2000-06-6B	2081-12-6S	2001-6-6B, 2082-6S
-8	2000-12-8B	**	900599-8
-10	2000-12-10B	**	900599-10
-12	2000-12-12B	**	2001-8-12B, 2082-8S

*Two adapters are required per hose assembly to be tested.

Male pipe

-2	2081-08-02S	2081-12-08S	2046-2-2S, 2082-2S
-4	2081-08-04S	2081-12-08S	2046-4-4S, 2082-4S
-6	2081-08-06S	2081-12-08S	2046-6-6S, 2082-6S
-8	2081-08-08S	**	2046-8-8S, 2082-8S
-12		**	2046-12-12S, 2082-12S
-16	2040-12-16S	**	2046-16-16S, 2082-16S
-20	2040-16-20S	2040-12-16S	2046-20-20S, 2082-20S
-24	2040-20-24S	2040-12-16S, 2040-16-20S	2046-24-24S, 2082-24S
-32	2040-24-32S	2040-12-16S, 2040-16-20S, 2040-20-24S	2046-32-32S, 2082-32S

*Two adapters are required per hose assembly to be tested.

**Internal Skive fittings only.

FT1058

Hose proof test stand

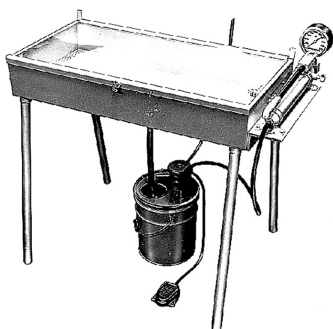

- Pressure gauge
- Release valve
- Hand hydraulic pump
- Foot switch
- Fluid reservoir, use SAE 5 wt. hydraulic oil (oil not included)
- Electric fluid pump
- Safety lid
- Pressure port (3/4-14 NPTF Female Port)
- 42" x 22" x 9" (41" with legs), 75 lbs
- 10,000 psi maximum proof pressure

110V 60 Hz, single phase motor

FT1058 as shown above. Legs can be removed for bench mounting.

FT1058 Adapter selection chart

Hose fitting* style and size	Fitting adapter part #	Pressure port adapter part #	Plug or cap part #
SAE 37°(JIC) swivel			
-4	2021-6-4S	2081-12-6S	900599-4
-5	2021-6-5S	2081-12-6S	900599-5
-6	2021-12-6S	-	900599-6
-8	2021-12-8S	-	900599-8
-10	2021-12-10S	-	900599-10
-12	2021-12-12S	-	900599-12
-16	2021-12-16S	-	900599-16
-20	2021-16-20S	2040-12-16S	900599-20
-24	2021-16-24S	2040-12-16S	900599-24
-32	2021-16-32S	2040-12-16S	900599-32
SAE 45° swivel			
-4	2000-06-04B	2081-12-6S	900599-4
-5	2000-06-05B	2081-12-6S	900599-5
-6	2000-06-06B	2081-12-6S	2001-6-6B, 2082-6S
-8	2000-12-08B	-	900599-8
-10	2000-12-10B	-	900599-10
-12	2000-12-12B	-	2001-8-12B, 2082-8S
Male pipe			
-2	2081-8-2S	2081-12-8S	2046-1-2S, 2082-2S
-4	2081-8-4S	2081-12-8S	2046-4-4S, 2082-4S
-6	2081-8-6S	2081-12-8S	2046-6-6S, 2082-6S
-8	2081-12-8S	-	2046-8-8S, 2082-8S
-12		-	2046-12-12S, 2082-12S
-16	2040-12-16S	-	2046-16-16S, 2082-16S
-20	2040-16-20S	2040-12-16S	2046-20-20S, 2082-20S
-24	2040-20-24S	2040-12-16S, 2040-16-20S	2046-24-24S, 2082-24S
-32	2040-24-32S	2040-12-16S, 2040-16-20S, 2040-20-24S	2046-32-32S, 2082-32S

*Adapters are available for other hose fitting styles. Contact Danfoss.

Contamination control

FT1455 series

Projectile cleaning system



FT1455 Series is focused on eliminating contamination in hydraulic systems. Contamination control is crucial during the preparation processes in assembling fittings on hose, tubes, and pipes. These systems shoot the FT1355 Series cleaning projectiles through hose, tubes, and pipe assemblies to successfully remove rubber dust and metal particles arising from the hydraulic hose cutting process, remove metal flashings from the hose assembly process (crimping), and remove contaminated oil from hoses, tubes and pipes prior to installation in hydraulics systems.

- Provides industry leading ISO cleanliness levels
- Simple and robust construction
- Available in hand-held and bench-mount configurations
- Ideal for portable small volume applications, and large volume production applications
- Broad variety of projectile and nozzle types and sizes to match application needs
- Minimal setup, works off shop air (80–110 psi)
- Capability: 1/8" to 4 1/2" ID hose, tube or pipe
- Available in kits or individual replacement hardware components
- Kits available with and without projectiles

Typical applications

Hydraulics

- Removes rubber dust and metal particles from the hydraulic hose cutting process
- Removes metal flash from the crimping process on hose and tubes
- Removal of contaminated oil from hoses, tubes and pipes in hydraulic systems

Pneumatics

- Eliminates rubber contamination, metal particles, contaminated oil and moisture that causes breakdowns and inefficiency

Heat exchangers & condenser

- Eliminates contamination that reduces heat transfer resulting in low level performance

Steam boilers

- Removes most scaling in steam pipes for maintenance servicing

Air conditioning & refrigeration

- Eliminates minute particles in copper tubes and coolant lines that affect system performance

Oxygen & gas

- Eliminates oil, grease and other contaminants from copper or S/S tubing

Oil, gas & chemical processing

- Efficient cleaning of pipes as part of service maintenance

Earthmoving equipment

- Maintenance reduction in flushing time and filter usage

Automotive & servicing

- Cleaning of fuel lines and brake lines prior to assembly and servicing of components

Food & beverage

- Product recovery retrieval of product from lines. Reducing or eliminating solvents or detergents

Gun barrels

- To remove rust, scale or powder residue much faster than brushing or swabbing

FT1455 series

Hardware



FT1455-L1

Hand held projectile cleaning hardware for small hose diameters (up to 1-1/4" hose ID)

- Capability – For use with 1/8" through 1-1/4" ID hose, tube or pipe assemblies
- Construction – Simple construction with durable brass and aluminum parts with rigid plastic handle
- Form factor – Hand-held, portable - ideal for mobile applications
- Typical applications: small volume hose shop environments
- Includes hand-held launcher hardware only. Does not include adapter rings and nozzles for operation. Intended for replacement purposes only



FT1455-L2

Hand held projectile cleaning hardware for medium hose diameters (up to 2" hose ID)

- Capability – For use with 1/8" through 2" ID hose, tube or pipe assemblies
- Construction - Precision machined aluminum with fully anodized components
- Form factor – Hand-held, portable – ideal for harsh environments and heavy use
- Typical applications: Production hose and tube shops, mobile hose fabricators and mobile applications
- Includes hand-held launcher hardware only. Does not include adapter rings and nozzles for operation. Intended for replacement purposes only



FT1455-L3

Hand held projectile cleaning hardware for large hose diameters (up to 3-1/2" hose ID)*

- Capability – For use with 1/8" through 3-1/2" ID hose, tube or pipe assemblies
- Construction - Precision machined aluminum with fully anodized components
- Form factor – Hand-held, portable – ideal for harsh environments and heavy use
- Typical applications: Production hose and tube shops, mobile hose fabricators and mobile applications
- Includes hand-held launcher hardware only. Does not include adapter rings and nozzles for operation. Intended for replacement purposes only



FT1455-L4

Bench mount projectile cleaning hardware kit for small hose diameters (up to 1-1/4" hose ID)*

- Capability – For use with 1/8" through 1-1/4" ID hose, tube or pipe assemblies
- Construction – Stainless steel housing with anodized aluminum components
- Form factor – Bench mount – ideal for production assemblies (1.2 second cycle time)
- Typical applications: Production hose and tube shops
- Includes bench mount launcher hardware, 5 micron air filter, pneumatic foot switch and twin line air hose and 7 nozzles for hose ID ranging from 1/4" through 1-1/4"

NOTE: For proper operation the following are required:

- 80 psi (5.5 Bar) minimum to 110 psi (7.5 Bar) maximum air pressure
- 1/2" ID air hose with a minimum of 55 SCFM (1.6 m³/min) air flow rate†
- 5 micron air filter and regulator with gauge are strongly suggested
- A large industrial compressor is strongly recommended
- A compressed air dryer is strongly recommended

†A minimum of 38 SCFM (1.1 m³/min) air flow rate at 80 psi (5.5 bar) is required for FT1455-L3 launcher
*FT1455-L3 can be converted to work on hose ID up to 4" with the addition of FT1455-N-45 4-1/2" aluminum locking nozzle.

Contamination control

FT1455 series

Projectile cleaning system kit



FT1455-K3

Hand held projectile cleaning kit
for medium hose diameters (up to 2" hose ID)

- Capability – For use with 1/4" through 2" ID hose, tube or pipe assemblies
- Construction – Precision machined aluminum with fully anodized components
- Form factor – Hand-held, portable – ideal for harsh environments and heavy use
- Typical applications – Production hose and tube shops, mobile hose fabricators and mobile applications

FT1455 series

Cleaning nozzles



FT1455-N-HXX

Nozzles for hose assemblies

- Universal nozzle for use with hoses
- Also work on pipe, heavy walled tubing and many fitting configurations

Broad variety of nozzles are available allowing the operator to select the ideal nozzle for each application based on the different size and type of hoses, hose fittings, tube and pipe assemblies. All nozzle sizes are denoted by the projectile exit diameter (mm).

FT1455-N-HXX nozzles	
Part #	Description
FT1455-N-HXX	Nozzles for hose assemblies
FT1455-N-H06	Hose nozzle (1/4")
FT1455-N-H08	Hose nozzle (5/16")
FT1455-N-H10	Hose nozzle (3/8")
FT1455-N-H13	Hose nozzle (1/2")
FT1455-N-H16	Hose nozzle (5/8")
FT1455-N-H19	Hose nozzle (3/4")
FT1455-N-H25	Hose nozzle (1")
FT1455-N-H32	Hose nozzle (1-1/4")
FT1455-N-H38	Hose nozzle (1-1/2")
FT1455-N-H50	Hose nozzle (2")
FT1455-N-U55	Universal hose nozzle (1-1/8" thru 3-1/2")
FT1455-N-45	4-1/2" aluminum locking nozzle



FT1455-J-XX

Nozzles for hose assemblies with JIC fittings

- Nozzles molded with 37° male flare on tip to fit female JIC fittings on hose assemblies

FT1455-J-XX nozzles	
Part #	Description
FT1455-J-XX	Nozzles for tube assemblies (Metric) Outside diameter X wall thickness
FT1455-J-06	JIC nozzle (4-1/2")
FT1455-J-10	JIC nozzle (4-1/2")
FT1455-J-13	JIC/TUBE nozzle (-8, 1/2")
FT1455-J-16	JIC/TUBE nozzle (-10, 5/8")
FT1455-J-19	JIC/TUBE nozzle (-12, 3/4")
FT1455-J-25	JIC/TUBE nozzle (-16, 1" & 7/8")
FT1455-J-32	JIC/TUBE nozzle (-20, 1-1/4" & 1")
FT1455-J-38	JIC/TUBE nozzle (-24, 1-1/2")
FT1455-J-50	JIC/TUBE nozzle (-32, 2")

FT1455 series (cont.)

Cleaning nozzles



FT1455-NT-XX

Nozzles for tube assemblies (Inch)

- Nominal inch tube nozzles have a lip on the inside that forms an airtight seal when tube is fully inserted into the nozzle



FT1455-NT-XXXXX

Nozzles for tube assemblies (Metric)

- Metric tube nozzles have a lip on the inside that forms an airtight seal when tube is fully inserted into the nozzle
- Metric tube nozzle designations utilize the largest wall thickness for a given outside diameter, but fit all smaller wall thicknesses as well

Broad variety of nozzles are available allowing the operator to select the ideal nozzle for each application based on the different size and type of hoses, hose fittings, tube and pipe assemblies. All nozzle sizes are denoted by the projectile exit diameter (mm).

FT1455-NT-XX nozzles	
FT1455-NT-XX	Nozzles for tube assemblies (Inch)
FT1455-NT-32	TUBE nozzle 1-1/4" OD
FT1455-NT-06	TUBE nozzle 1/4" OD
FT1455-NT-03	TUBE nozzle 1/8" OD
FT1455-NT-10	TUBE nozzle 3/8" OD
FT1455-NT-08	TUBE nozzle 5/16" OD

FT1455-NT-XXXXX nozzles	
FT1455-NT-XX	Nozzles for tube assemblies (Metric) Outside diameter X wall thickness
FT1455-NT-06x1.5	Metric tube nozzle UC-6 X 1.5
FT1455-NT-08x1.5	Metric tube nozzle UC-8 X 1.5
FT1455-NT-10x1.5	Metric tube nozzle UC-10 X 1.5
FT1455-NT-12x2.0	Metric tube nozzle UC-12 X 2.0
FT1455-NT-14x2.0	Metric tube nozzle UC-14 X 2.0
FT1455-NT-15x2.0	Metric tube nozzle UC-15 X 2.0
FT1455-NT-16x2.5	Metric tube nozzle UC-16 X 2.5
FT1455-NT-18x2.5	Metric tube nozzle UC-18 X 2.5
FT1455-NT-20x3.0	Metric tube nozzle UC-20 X 3.0
FT1455-NT-22x2.0	Metric tube nozzle UC-22 X 2.0
FT1455-NT-25x3.0	Metric tube nozzle UC-25 X 3.0
FT1455-NT-28x2.5	Metric tube nozzle UC-28 X 2.5
FT1455-NT-30x4.0	Metric tube nozzle UC-30 X 4.0
FT1455-NT-35x3.0	Metric tube nozzle UC-35 X 3.0
FT1455-NT-38x5.0	Metric tube nozzle UC-38 X 5.0
FT1455-NT-42x3.0	Metric tube nozzle UC-42 X 3.0
FT1455-NT-50x5.0	Metric tube nozzle UC-50 X 5.0
FT1455-4FFORX	Nozzle for use with flat face O-Ring seal fittings (FORS)

Contamination control

FT1455 series

Adapter & locking rings

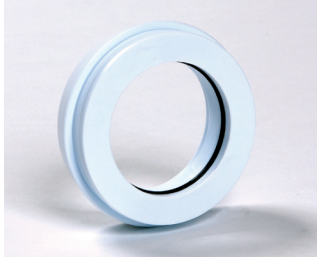

FT1455-L2-AR1

Adapter ring

Adapter ring for FT1455-L2 launcher to receive 1/8" thru 1-1/4" nozzles

- FT1455-L2-AR1 adapter ring fits the FT1455-L2 hand held launcher and all nozzle types and sizes between 1/8" and 1-1/4"



FT1455-L3-LR

Locking ring

3-1/2" aluminum locking ring for FT1455-L3 launcher FT1455-L3-LR locking ring fits

- FT1455-L3 hand held launcher, both FT1455-L3-AR2 & FT1455-L3-AR3 adapter rings, and FT1455-N-U55 Universal hose nozzle



FT1455-L3-AR2

Adapter ring

Adapter ring for FT1455-L3 launcher to receive 1/8" thru 1-1/4" nozzles

- FT1455-L3-AR2 adapter ring fits the FT1455-L3 hand held launcher and all nozzle types and sizes between 1/8" and 1-1/4"



FT1455-L3-AR3

Adapter ring

Adapter ring for FT1455-L3 launcher to receive 1-1/2" thru 2" nozzles

- FT1455-L3-AR3 adapter ring fits the FT1455-L3 hand held launcher and all nozzle types and sizes between 1-1/2" and 2".

FT1455 series

Accessories

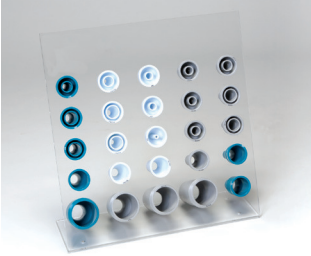

FT1455-NH25

Desktop nozzle holder

- The desktop nozzle holder is a great alternative to storing the nozzles in the carrying case
- Can be easily attached to the workbench and offers easy access during change overs and operation
- Accommodates all types of nozzles ranging from 1/4" to 2"



FT1455-QC

Quick release coupling

- Quick release coupling offers a quick disconnect and exchange of air supply to all three models of hand held projectile launchers
- Ideal for portable applications that require frequent disconnects



FT1455-CC

Carrying case

- Convenient carrying case to store and carry the hand held projectile launchers and relevant nozzles
- Works with all 3 models of hand held projectile launchers

FT1455 operating instructions

Manuals

FT1455-L1

Operators Manual

Doc #: AQ445452721726en-000101

FT1455-L3

Operators Manual

Doc #: AQ445452770728en-000101

FT1455-L2

Operators Manual

Doc #: AQ445452746727en-000101

FT1455-L4

Operators Manual

Doc #: AQ445452791729en-000101

Contamination control

FT1455 & FT1355 series

Recommended nozzles and cleaning projectiles for hoses and hose assemblies

Recommendations for hoses: nominal hose diameter

Inches	mm	Nozzle part #	Cleaning projectile part #
3/16	05	FT1455-N-H06	FT1355-H-06 -
1/4	06	FT1455-N-H06	FT1355-H-10 or FT1355-H-12
5/16	08	FT1455-N-H08	FT1355-H-12 or FT1355-H-14
3/8	10	FT1455-N-H10	FT1355-H-14 or FT1355-H-16
1/2	13	FT1455-N-H13	FT1355-H-18 or FT1355-H-20
5/8	16	FT1455-N-H16	FT1355-H-22 -
3/4	19	FT1455-N-H19	FT1355-H-26 -
1	25	FT1455-N-H25	FT1355-H-33 or FT1355-H-36
1-1/4	32	FT1455-N-H32	FT1355-H-40 or FT1355-H-45
1-1/2	38	FT1455-N-H38	FT1355-H-50 or FT1355-H-55
2	50	FT1455-N-H50	FT1355-H-60 or FT1355-H-65
2-1/2	63	FT1455-N-U55	FT1355-H-75 -
3	76	FT1455-N-U55	FT1355-H-85 -
3-1/2	89	FT1455-N-U55	FT1355-H-100 -
4	102	FT1455-N-45	- -
4-1/2	114	FT1455-N-45	- -

Recommendations for hose assemblies with ORS fittings

ORS fitting dash size	Nozzle part #	Cleaning projectile part #
-4	FT1455-4FFORX	FT1355-H-06 or FT1355-H-07
-6	FT1455-N-H06	FT1355-H-12 -
-8	FT1455-N-H10	FT1355-H-16 -
-10	FT1455-N-H13	FT1355-H-22 -
-12	FT1455-N-H16	FT1355-H-26 -
-16	FT1455-N-H19	FT1355-H-33 -
-20	FT1455-N-H25	FT1355-H-40 -

Recommendations for hose assemblies with Code 61 or 62 flanges

Code 61 or 62 flange dash size	Nozzle part #	Cleaning projectile part #
-8	FT1455-N-H10	FT1355-H-16
-10	FT1455-N-H13	FT1355-H-22
-12	FT1455-N-H16	FT1355-H-26
-16	FT1455-N-H19	FT1355-H-33
-20	FT1455-N-H25	FT1355-H-40
-24	FT1455-N-H32	FT1355-H-50
-32	FT1455-N-H32	FT1355-H-60

Recommendations for hose assemblies with JIC fittings

JIC fitting dash size	Nozzle part #	Cleaning projectile part #
-4	FT1455-J-06	FT1355-H-06 or FT1355-H-07
-6	FT1455-J-10	FT1355-H-12
-8	FT1455-J-13	FT1355-H-16
-10	FT1455-J-16	FT1355-H-22
-12	FT1455-J-19	FT1355-H-26
-16	FT1455-J-25	FT1355-H-33
-20	FT1455-J-32	FT1355-H-40
-24	FT1455-J-38	FT1355-H-50
-32	FT1455-J-50	FT1355-H-60

FT1455 & FT1355 series

Recommended nozzles and cleaning projectiles for pipes and tubes

Recommended nozzles and cleaning projectiles for pipes (inch)

SCH 40	Nozzle part #	Cleaning projectile part #	Abrasive projectile part #
1/4"	FT1455-N-H08	FT1355-H-14	FT1355-A-12
3/8"	FT1455-N-H13	FT1355-H-18	FT1355-A-16
1/2"	FT1455-N-H16	FT1355-H-20	FT1355-A-18
3/4"	FT1455-N-H19	FT1355-H-30	FT1355-A-26
1	FT1455-N-H25	FT1355-H-36	FT1355-A-33
1-1/4"	FT1455-N-H32	FT1355-H-45	FT1355-A-40
1-1/2"	FT1455-N-H38	FT1355-H-55	FT1355-A-50
2"	FT1455-N-H50	FT1355-H-65	-
2-1/2"	FT1455-N-U55	FT1355-H-75	-
3"	FT1455-N-U55	FT1355-H-85	-
3-1/2"	FT1455-N-U55	FT1355-H-100	-

SCH 80	Nozzle part #	Cleaning projectile part #	Abrasive projectile part #
1/4"	FT1455-N-H06	FT1355-H-12	FT1355-A-10
3/8"	FT1455-N-H10	FT1355-H-16	FT1355-A-14
1/2"	FT1455-N-H13	FT1355-H-20	FT1355-A-16 or FT1355-A-18
3/4"	FT1455-N-H19	FT1355-H-26	FT1355-A-22
1"	FT1455-N-H25	FT1355-H-36	FT1355-A-30
1-1/4"	FT1455-N-H32	FT1355-H-45	FT1355-A-40
1-1/2"	FT1455-N-H38	FT1355-H-50	FT1355-A-45
2"	FT1455-N-H38	FT1355-H-60	FT1355-A-55
2-1/2"	FT1455-N-H50	FT1355-H-70	-
3"	FT1455-N-U55	FT1355-H-85	-
3-1/2"	FT1455-N-U55	FT1355-H-100	-

SCH 160	Nozzle part #	Cleaning projectile part #	Abrasive projectile part #
1/2"	FT1455-N-H10	FT1355-H-16	FT1355-A-14
3/4"	FT1455-N-H16	FT1355-H-20	FT1355-A-18
1"	FT1455-N-H19	FT1355-H-30	FT1355-A-26
1-1/4"	FT1455-N-H25	FT1355-H-36	FT1355-A-33
1-1/2"	FT1455-N-H32	FT1355-H-45	FT1355-A-40
2"	FT1455-N-H38	FT1355-H-55	FT1355-A-45 or FT1355-A-50
2-1/2"	FT1455-N-H50	FT1355-H-65	FT1355-A-60
3"	FT1455-N-U55	FT1355-H-75	-
4"	FT1455-N-U55	FT1355-H-100	-

Recommended nozzles and cleaning projectiles for tubes (inch)

Outside diameter x wall thickness	Nozzle part #	Cleaning projectile part #	Abrasive projectile part #	Tube projectile part #
1/8" X 0.030"	FT1455-NT-3	-	-	-
1/4" X 0.035"	FT1455-NT-6	FT1355-H-10	FT1355-A-07	FT1355-T-06
1/4" X 0.049"	FT1455-NT-6	FT1355-H-08	FT1355-A-07	FT1355-T-06
1/4" X 0.065"	FT1455-NT-6	FT1355-H-07	-	FT1355-T-06
5/16" X 0.035"	FT1455-NT-8	FT1355-H-12	FT1355-A-10	FT1355-T-07
3/8" X 0.035"-0.049"	FT1455-NT-10	FT1355-H-14	FT1355-A-12	FT1355-T-10
3/8" X 0.065"	FT1455-NT-10	FT1355-H-12	FT1355-A-10	FT1355-T-10
1/2" X 0.035"	FT1455-J-13	FT1355-H-16	FT1355-A-16	FT1355-T-14
1/2" X 0.049"	FT1455-J-13	FT1355-H-16	FT1355-A-16	FT1355-T-12
1/2" X 0.065"	FT1455-J-13	FT1355-H-16	FT1355-A-14	FT1355-T-12
1/2" X 0.083"	FT1455-J-13	FT1355-H-14	FT1355-A-12	FT1355-T-12
5/8" X 0.049"	FT1455-J-16	FT1355-H-22	FT1355-A-20	FT1355-T-16
5/8" X 0.065"	FT1455-J-16	FT1355-H-20	FT1355-A-18	FT1355-T-16
5/8" X 0.083"	FT1455-J-16	FT1355-H-20	FT1355-A-18	FT1355-T-14
3/4" X 0.049"-0.065"	FT1455-J-19	FT1355-H-26	FT1355-A-24	FT1355-T-20
3/4" X 0.095"	FT1455-J-19	FT1355-H-22	FT1355-A-20	FT1355-T-18
7/8" X 0.049"	FT1455-J-25	FT1355-H-33	FT1355-A-30	FT1355-T-26
7/8" X 0.065"	FT1455-J-25	FT1355-H-30	FT1355-A-28	FT1355-T-22
7/8" X 0.095"	FT1455-N-H16	FT1355-H-28	FT1355-A-26	FT1355-T-22
1" X 0.065"	FT1455-J-32	FT1355-H-33	FT1355-A-30	FT1355-T-28
1" X 0.083"-0.095"	FT1455-J-32	FT1355-H-33	FT1355-A-30	FT1355-T-26
1" X 0.120"	FT1455-J-32	FT1355-H-30	FT1355-A-28	FT1355-T-26
1 1/4" X 0.065"	FT1455-NT-32	FT1355-H-40	FT1355-A-40	FT1355-T-33
1 1/4" X 0.083"	FT1455-NT-32	FT1355-H-40	FT1355-A-36	FT1355-T-33
1 1/4" X 0.095"	FT1455-NT-32	FT1355-H-40	FT1355-A-36	FT1355-T-33
1 1/4" X 0.109"	FT1455-NT-32	FT1355-H-36	FT1355-A-36	FT1355-T-33
1 1/4" X 0.120"	FT1455-NT-32	FT1355-H-36	FT1355-A-33	FT1355-T-33
1 1/2" X 0.065"-0.120"	FT1455-J-38	FT1355-H-50	FT1355-A-45	FT1355-T-40
1 1/2" X 0.134"-0.148"	FT1455-J-38	FT1355-H-45	FT1355-A-40	FT1355-T-40
2" X 0.065"-0.120"	FT1455-J-50	FT1355-H-60	FT1355-A-55	FT1355-T-50
2" X 0.134"-0.188"	FT1455-J-50	FT1355-H-55	FT1355-A-50	FT1355-T-50

Contamination control

FT1455 & FT1355 series

Recommended nozzles and cleaning projectiles for tubes (metric)

Nozzles & cleaning projectiles for tubes				
Outside diameter x wall thickness	Nozzle part #	Cleaning projectile part #	Abrasive projectile part #	Tube projectile part #
6 X 1.0	FT1455-NT-06x1.5	FT1355-H-07	FT1355-A-06	FT1355-T-06
6 X 1.5	FT1455-NT-06x1.5	FT1355-H-07	FT1355-A-06	-
8 X 1.0	FT1455-NT-08x1.5	FT1355-H-10	FT1355-A-07	FT1355-T-07
8 X 1.5	FT1455-NT-08x1.5	FT1355-H-10	FT1355-A-07	FT1355-T-07
10 X 1.0	FT1455-NT-10x1.5	FT1355-H-14	FT1355-A-12	FT1355-T-12
10 X 1.5	FT1455-NT-10x1.5	FT1355-H-14	FT1355-A-12	FT1355-T-12
12 X 1.0	FT1455-NT-12x2.0	FT1355-H-16	FT1355-A-14	FT1355-T-14
12 X 1.5	FT1455-NT-12x2.0	FT1355-H-16	FT1355-A-14	FT1355-T-14
12 X 2.0	FT1455-NT-12x2.0	FT1355-H-14	FT1355-A-12	FT1355-T-12
14 X 1.0	FT1455-NT-14x2.0	FT1355-H-18	FT1355-A-16	FT1355-T-16
14 X 1.5	FT1455-NT-14x2.0	FT1355-H-16	FT1355-A-14	FT1355-T-14
14 X 2.0	FT1455-NT-14x2.0	FT1355-H-16	FT1355-A-14	FT1355-T-14
15 X 1.0	FT1455-NT-15x2.0	FT1355-H-20	FT1355-A-18	FT1355-T-16
15 X 1.5	FT1455-NT-15x2.0	FT1355-H-18	FT1355-A-16	FT1355-T-16
15 X 2.0	FT1455-NT-15x2.0	FT1355-H-16	FT1355-A-14	FT1355-T-14
16 X 1.0	FT1455-NT-16x2.5	FT1355-H-22	FT1355-A-20	FT1355-T-18
16 X 1.5	FT1455-NT-16x2.5	FT1355-H-20	FT1355-A-18	FT1355-T-16
16 X 2.0	FT1455-NT-16x2.5	FT1355-H-18	FT1355-A-16	FT1355-T-16
16 X 2.5	FT1455-NT-16x2.5	FT1355-H-16	FT1355-A-14	FT1355-T-14
18 X 1.0	FT1455-NT-18x2.5	FT1355-H-24	FT1355-A-22	FT1355-T-20
18 X 1.5	FT1455-NT-18x2.5	FT1355-H-24	FT1355-A-20	FT1355-T-18
18 X 2.0	FT1455-NT-18x2.5	FT1355-H-22	FT1355-A-20	FT1355-T-18
18 X 2.5	FT1455-NT-18x2.5	FT1355-H-20	FT1355-A-18	FT1355-T-16
20 X 1.5	FT1455-NT-20x3.0	FT1355-H-26	FT1355-A-24	FT1355-T-22
20 X 2.0	FT1455-NT-20x3.0	FT1355-H-24	FT1355-A-22	FT1355-T-20
20 X 2.5	FT1455-NT-20x3.0	FT1355-H-24	FT1355-A-20	FT1355-T-18
20 X 3	FT1455-NT-20x3.0	FT1355-H-22	FT1355-A-20	FT1355-T-18

Nozzles & cleaning projectiles for tubes				
Outside diameter x wall thickness	Nozzle part #	Cleaning projectile part #	Abrasive projectile part #	Tube projectile part #
22 X 1	FT1455-NT-22x2.0	FT1355-H-30	FT1355-A-28	FT1355-T-26
22 X 1.5	FT1455-NT-22x2.0	FT1355-H-30	FT1355-A-28	FT1355-T-26
22 X 2	FT1455-NT-22x2.0	FT1355-H-30	FT1355-A-28	FT1355-T-26
25 X 2	FT1455-NT-25x3.0	FT1355-H-33	FT1355-A-30	FT1355-T-28
25 X 2.5	FT1455-NT-25x3.0	FT1355-H-30	FT1355-A-28	FT1355-T-26
25 X 3	FT1455-NT-25x3.0	FT1355-H-30	FT1355-A-28	FT1355-T-26
28 X 2	FT1455-NT-28x2.5	FT1355-H-36	FT1355-A-33	FT1355-T-33
28 X 2.5	FT1455-NT-28x2.5	FT1355-H-36	FT1355-A-33	FT1355-T-30
30 X 2	FT1455-NT-30x4.0	FT1355-H-36	FT1355-A-33	FT1355-T-33
30 X 2.5	FT1455-NT-30x4.0	FT1355-H-36	FT1355-A-33	FT1355-T-30
30 X 3	FT1455-NT-30x4.0	FT1355-H-36	FT1355-A-33	FT1355-T-30
30 X 4	FT1455-NT-30x4.0	FT1355-H-36	FT1355-A-33	FT1355-T-30
35 X 2	FT1455-NT-35x3.0	FT1355-H-45	FT1355-A-40	FT1355-T-40
35 X 3	FT1455-NT-35x3.0	FT1355-H-40	FT1355-A-36	FT1355-T-36
35 X 4	FT1455-N-H25	FT1355-H-40	FT1355-A-36	FT1355-T-33
35 X 5	FT1455-N-H25	FT1355-H-36	FT1355-A-33	FT1355-T-30
38 X 2.5	FT1455-NT-38x5.0	FT1355-H-50	FT1355-A-45	FT1355-T-40
38 X 3	FT1455-NT-38x5.0	FT1355-H-50	FT1355-A-45	FT1355-T-40
38 X 4	FT1455-NT-38x5.0	FT1355-H-45	FT1355-A-40	FT1355-T-40
38 X 5	FT1455-NT-38x5.0	FT1355-H-40	FT1355-A-36	FT1355-T-36
42 X 2	FT1455-NT-42x3.0	FT1355-H-55	FT1355-A-50	FT1355-T-50
42 X 3	FT1455-NT-42x3.0	FT1355-H-50	FT1355-A-50	FT1355-T-45
50 X 3	FT1455-NT-50x5.0	FT1355-H-60	FT1355-A-55	FT1355-T-55
50 X 5	FT1455-NT-50x5.0	FT1355-H-55	FT1355-A-55	FT1355-T-50
50 X 6	FT1455-NT-50x5.0	FT1355-H-55	FT1355-A-50	FT1355-T-50

FT1355 series

Cleaning projectiles for hose, tube and pipe assemblies

FT1355 cleaning projectiles work by being compressed against the internal surface of the hose, tube or pipe. Cleaning projectile selection should favor a diameter 20% to 30% larger than the internal diameter of the hose, tube of pipe being cleaned.

Projectiles are available in 3 variations as outlined below, and are manufactured from virgin materials with a specific cell structure and density to match the application's needs. Appropriate selection of the cleaning projectile based on the type of application ensures effective cleaning.



FT1355-H-XX

Hose cleaning projectiles for hose assemblies

- Universal cleaning projectile for use with hose, tube and pipe assemblies
- Removes fine particles of loose contaminants after cutting operations
- Can also be used for product purging prior to assembly

FT1355-H-XX cleaning projectiles for hose assemblies

Part #	Description
FT1355-H-05	Hose cleaning projectile (5mm)
FT1355-H-06	Hose cleaning projectile (6mm)
FT1355-H-07	Hose cleaning projectile (7mm)
FT1355-H-08	Hose cleaning projectile (8mm)
FT1355-H-10	Hose cleaning projectile (10mm)
FT1355-H-12	Hose cleaning projectile (12mm)
FT1355-H-14	Hose cleaning projectile (14mm)
FT1355-H-16	Hose cleaning projectile (16mm)
FT1355-H-18	Hose cleaning projectile (18mm)
FT1355-H-20	Hose cleaning projectile (20mm)
FT1355-H-22	Hose cleaning projectile (22mm)
FT1355-H-24	Hose cleaning projectile (24mm)
FT1355-H-26	Hose cleaning projectile (26mm)
FT1355-H-28	Hose cleaning projectile (28mm)
FT1355-H-30	Hose cleaning projectile (30mm)
FT1355-H-33	Hose cleaning projectile (33mm)
FT1355-H-36	Hose cleaning projectile (36mm)
FT1355-H-40	Hose cleaning projectile (40mm)
FT1355-H-45	Hose cleaning projectile (45mm)
FT1355-H-50	Hose cleaning projectile (50mm)
FT1355-H-55	Hose cleaning projectile (55mm)
FT1355-H-60	Hose cleaning projectile (60mm)
FT1355-H-65	Hose cleaning projectile (65mm)
FT1355-H-70	Hose cleaning projectile (70mm)
FT1355-H-75	Hose cleaning projectile (75mm)
FT1355-H-80	Hose cleaning projectile (80mm)
FT1355-H-85	Hose cleaning projectile (85mm)
FT1355-H-90	Hose cleaning projectile (90mm)
FT1355-H-95	Hose cleaning projectile (95mm)
FT1355-H-100	Hose cleaning projectile (100mm)

Contamination control

FT1355 series

Cleaning projectiles for tube and pipe assemblies



FT1355-A-XX

Abrasive cleaning projectiles for tube and pipe assemblies

- For use with tubes or pipe assemblies
- Removes mild to medium amounts of contaminants including surface rust and scale build-up
- Can be used multiple times

FT1355-A-XX abrasive cleaning projectiles for tube and pipe assemblies

Part #	Description
FT1355-A-06	Abrasive cleaning projectile (6mm)
FT1355-A-07	Abrasive cleaning projectile (7mm)
FT1355-A-10	Abrasive cleaning projectile (10mm)
FT1355-A-12	Abrasive cleaning projectile (12mm)
FT1355-A-14	Abrasive cleaning projectile (14mm)
FT1355-A-16	Abrasive cleaning projectile (16mm)
FT1355-A-18	Abrasive cleaning projectile (18mm)
FT1355-A-20	Abrasive cleaning projectile (20mm)
FT1355-A-22	Abrasive cleaning projectile (22mm)
FT1355-A-24	Abrasive cleaning projectile (24mm)
FT1355-A-26	Abrasive cleaning projectile (26mm)
FT1355-A-28	Abrasive cleaning projectile (28mm)
FT1355-A-30	Abrasive cleaning projectile (30mm)
FT1355-A-33	Abrasive cleaning projectile (33mm)
FT1355-A-36	Abrasive cleaning projectile (36mm)
FT1355-A-40	Abrasive cleaning projectile (40mm)
FT1355-A-45	Abrasive cleaning projectile (45mm)
FT1355-A-50	Abrasive cleaning projectile (50mm)
FT1355-A-55	Abrasive cleaning projectile (55mm)
FT1355-A-60	Abrasive cleaning projectile (60mm)



FT1355-T-XX

Tube cleaning projectiles for tube and pipe assemblies

- Cleaning projectiles for use with tube and pipe assemblies
- Removes mild to medium amounts of contaminants including surface rust and scale build-up
- Removes mandrel lubricants, grease and other oils typically used in bending processes
- Strongly recommended for cleaning stainless steel tubes

FT1355-T-XX tube cleaning projectiles for tube assemblies

Part #	Description
FT1355-T-06	Tube cleaning projectile (6mm)
FT1355-T-07	Tube cleaning projectile (7mm)
FT1355-T-10	Tube cleaning projectile (10mm)
FT1355-T-12	Tube cleaning projectile (12mm)
FT1355-T-14	Tube cleaning projectile (14mm)
FT1355-T-16	Tube cleaning projectile (16mm)
FT1355-T-18	Tube cleaning projectile (18mm)
FT1355-T-20	Tube cleaning projectile (20mm)
FT1355-T-22	Tube cleaning projectile (22mm)
FT1355-T-24	Tube cleaning projectile (24mm)
FT1355-T-26	Tube cleaning projectile (26mm)
FT1355-T-28	Tube cleaning projectile (28mm)
FT1355-T-30	Tube cleaning projectile (30mm)
FT1355-T-33	Tube cleaning projectile (33mm)
FT1355-T-36	Tube cleaning projectile (36mm)
FT1355-T-40	Tube cleaning projectile (40mm)
FT1355-T-45	Tube cleaning projectile (45mm)
FT1355-T-50	Tube cleaning projectile (50mm)
FT1355-T-55	Tube cleaning projectile (55mm)
FT1355-T-60	Tube cleaning projectile (60mm)

FT1355 series

Cleaning projectile selection ordering guidelines

Order quantity is one bag
(ex.. A 1 piece order will be for the full bag quantity noted below)

FT1355 projectile ordering guide		
Danfoss projectile part #	Description	Qty / bag
FT1355-A-06	ABRASIVE (06mm) (Pkg 100)	100
FT1355-A-07	ABRASIVE (07mm) (Pkg 100)	100
FT1355-A-10	ABRASIVE (10mm) (Pkg 100)	100
FT1355-A-12	ABRASIVE (12mm) (Pkg 100)	100
FT1355-A-14	ABRASIVE (14mm) (Pkg 100)	100
FT1355-A-16	ABRASIVE (16mm) (Pkg 100)	100
FT1355-A-18	ABRASIVE (18mm) (Pkg 100)	100
FT1355-A-20	ABRASIVE (20mm) (Pkg 50)	50
FT1355-A-22	ABRASIVE (22mm) (Pkg 50)	50
FT1355-A-24	ABRASIVE (24mm) (Pkg 50)	50
FT1355-A-26	ABRASIVE (26mm) (Pkg 50)	50
FT1355-A-28	ABRASIVE (28mm) (Pkg 40)	40
FT1355-A-30	ABRASIVE (30mm) (Pkg 40)	40
FT1355-A-33	ABRASIVE (33mm) (Pkg 40)	40
FT1355-A-36	ABRASIVE (36mm) (Pkg 30)	30
FT1355-A-40	ABRASIVE (40mm) (Pkg 30)	30
FT1355-A-45	ABRASIVE (45mm) (Pkg 20)	20
FT1355-A-50	ABRASIVE (50mm) (Pkg 20)	20
FT1355-A-55	ABRASIVE (55mm) (Pkg 15)	15
FT1355-A-60	ABRASIVE (60mm) (Pkg 15)	15
FT1355-H-05	Low density hose projectile (5mm)	100
FT1355-H-06	Low density hose projectile (6mm)	100
FT1355-H-07	Low density hose projectile (7mm)	100
FT1355-H-08	Low density hose projectile (8mm)	100
FT1355-H-10	Low density hose projectile (10mm)	100
FT1355-H-12	Low density hose projectile (12mm)	100
FT1355-H-14	Low density hose projectile (14mm)	100
FT1355-H-16	Low density hose projectile (16mm)	100
FT1355-H-18	Low density hose projectile (18mm)	100
FT1355-H-20	Low density hose projectile (20mm)	50
FT1355-H-22	Low density hose projectile (22mm)	50
FT1355-H-24	Low density hose projectile (24mm)	50
FT1355-H-26	Low density hose projectile (26mm)	50
FT1355-H-28	Low density hose projectile (28mm)	40
FT1355-H-30	Low density hose projectile (30mm)	40

FT1355 projectile ordering guide		
Danfoss projectile part #	Description	Qty / bag
FT1355-H-33	Low density hose projectile (33mm)	40
FT1355-H-36	Low density hose projectile (36mm)	30
FT1355-H-40	Low density hose projectile (40mm)	30
FT1355-H-45	Low density hose projectile (45mm)	20
FT1355-H-50	Low density hose projectile (50mm)	20
FT1355-H-55	Low density hose projectile (55mm)	15
FT1355-H-60	Low density hose projectile (55mm)	15
FT1355-H-65	Low density hose projectile (60mm)	10
FT1355-H-70	Low density hose projectile (65mm)	10
FT1355-H-75	Low density hose projectile (70mm)	10
FT1355-H-80	Low density hose projectile (80mm)	10
FT1355-H-85	Low density hose projectile (85mm)	10
FT1355-H-90	Low density hose projectile (90mm)	10
FT1355-H-95	Low density hose projectile (95mm)	10
FT1355-H-100	Low density hose projectile (100mm)	10
FT1355-T-06	Tube projectile (06mm)	100
FT1355-T-07	Tube projectile (07mm)	100
FT1355-T-10	Tube projectile (10mm)	100
FT1355-T-12	Tube projectile (12mm)	100
FT1355-T-14	Tube projectile (14mm)	100
FT1355-T-16	Tube projectile (16mm)	100
FT1355-T-18	Tube projectile (18mm)	100
FT1355-T-20	Tube projectile (20mm)	50
FT1355-T-22	Tube projectile (22mm)	50
FT1355-T-24	Tube projectile (24mm)	50
FT1355-T-26	Tube projectile (26mm)	50
FT1355-T-28	Tube projectile (28mm)	40
FT1355-T-30	Tube projectile (30mm)	40
FT1355-T-33	Tube projectile (33mm)	40
FT1355-T-36	Tube projectile (36mm)	30
FT1355-T-40	Tube projectile (40mm)	30
FT1355-T-45	Tube projectile (45mm)	20
FT1355-T-50	Tube projectile (50mm)	20
FT1355-T-55	Tube projectile (55mm)	15
FT1355-T-60	Tube projectile (60mm)	15

Contamination control

FT1355 series

Cleaning projectile selection ordering guidelines

Order quantity is one bag
(ex. A 1 piece order will be for the full bag quantity noted below)

FT1355 cleaning projectile ordering		
FT1355 foam projectile part #'s for FT1455 projectile launchers	Order quantity is one bag (ex. A 1 piece order will be for the full bag quantity noted below)	Inner Diameter (ID) in inches of cut hose, and Hose assembly Dash size
FT1355-H-06	100	3/16" (-03)
FT1355-H-10 (or)	100	1/4" (-04)
FT1355-H-12*	100	
FT1355-H-12 (or)	100	5/16" (-05)
FT1355-H-14*	100	
FT1355-H-14 (or)	100	3/8" (-06)
FT1355-H-16*	100	
FT1355-H-18 (or)	100	1/2" (-08)
FT1355-H-20*	50	
FT1355-H-22	50	5/8" (-10)
FT1355-H-26	50	3/4" (-12)

FT1355 cleaning projectile ordering		
FT1355 foam projectile part #'s for FT1455 projectile launchers	Order quantity is one bag (ex. A 1 piece order will be for the full bag quantity noted below)	Inner Diameter (ID) in inches of cut hose, and Hose assembly Dash size
FT1355-H-33 (or)	40	1" (-16)
FT1355-H-36*	30	
FT1355-H-40	30	1-1/4" (-20)
FT1355-H-45*	20	
FT1355-H-50 (or)	20	1-1/2" (-24)
FT1355-H-55*	15	
FT1355-H-60 (or)	15	2" (-32)
FT1355-H-65*	10	
FT1355-H-75	10	2-1/2" (-40)
FT1355-H-85	10	3" (-48)
FT1355-H-100	10	3-1/2" (-64)

NOTE: *Use the larger projectile size for maximum cleaning on hose cut with an abrasive wheel



FT1555 CapSeal system



The FT1555 CapSeal system is intended to be used in conjunction with the FT1355 and FT1455 series projectile cleaning systems to prevent recontamination of hose, tube, and pipe assemblies. The FT1555 CapSeal system utilizes heat shrink technology to encapsulate the end of a hose or tube assembly with an FT1555 CapSeal capsule.

- Provides industry leading ISO cleanliness levels
- Robust construction for use in heavy duty applications
- Available in hand-held and bench-mount configurations
- Ideal for portable small volume applications, and large volume production applications
- Optimum CapSeal capsule design to meet a broad variety of applications
- Minimal setup
- Capability: 3/8" (10mm) to 3" (78mm OD) hose and fitting ends
- Available in kits or individual replacement hardware components
- Kits available with and without Capseal capsule

Capsule shrink time for CapSeal Systems at multiple intervals

Machine warm-up time from cold start (minutes)	1	2	3	4	5	6	7	8	9	10
Machine	Seal time (seconds)									
FT1555-BM230 	3.5	2.5	2	1.5	1.25	1	1	0.75	0.75	0.75
FT1555-BM120 	17	10	4.5	3.25	2.5	2.25	2	1.75	1.5	1.5
FT1555-HH 	10	12	6	4	3	3	2.5	2	1.75	1.75

Contamination control

FT1555 CapSeal system

Hardware



FT1555-HH

Hand held electric heat gun

- Variable temperature electronic heat gun with electronic thermocouple control.
- Duratherm heating element ensure long life and even heat temperature range of 120°F (49°C) to 1100°F (593°C) and a built-in cool down switch.
- Capable of sealing multiple hoses simultaneously.
- Operates on 120V AC power, draws 1500 watts, and can produce 17.6CFM.
- Cool down switch renders gun immediately cool-to-the-touch.



FT1555-BM120

120v Ak hand held heat gun with air knife

- A cradle holds and locks the 120V heat gun into place for bench top shrinking of capsules.
- The heat gun can be easily removed from the cradle for remote capsule shrinking.
- Magnetic puck holds the capsule onto the fitting for a perfect seal during the shrinking process.
- Magnetic puck pulls the swivel nut forward on 90° and 45° fittings for easy insertion into the air knife for capsule shrinking.
- Air knife has heat guard and large 110mm center opening that can be accessed from either side.
- Can seal single or multiple hose or tube assemblies.
- CapSeal capsules will seal hose or tube fitting from 3/8" OD (10mm) through 3" OD (78mm).



FT1555-BM230

CapSeal system with air knife

- Enables sealing of single or multiple hose or tube assemblies at one time.
- Magnetic puck holds capsule onto carbon steel fitting for a perfect seal during sealing process.
- Magnetic puck holds the nut forward on 90° and 45° fittings for easy insertion into the air knife.
- Air knife has heat guard and large 110mm center opening accessible from either side.
- Capsules fit and seal hose and tube fittings from 3/8" OD (10mm) through 3" OD (78mm).
- 230v single-phase AC power at 50/60Hz draws < 5 amps.
- ON/OFF rocker switch illuminates green when "on."
- Built in external air filter minimizes heat gun clogging and maintenance, increasing heat gun longevity.
- Heat side of machine is fully insulated.
- Dedicated air filter prevents airborne contamination during sealing.
- Please note that a L6-15 NEMA twist loc receptacle (not supplied) is required for operation.
- Durable, long-lasting brushless motor for high-volume production environments.

FT1555 CapSeal system

Kits



FT1555-HH-K1

Hand held electric heat gun basic kit

- Typical applications – Hose shops and mobile hose fabricators
- Capsules fit and seal hose and tube fittings from 3/8" OD (10mm) through 3" OD (78mm)
- FT1555-HH heat gun and air knife with 1 1/2" connection
- FT1555-SMP small magnetic puck
- FT1555-LMP large magnetic puck



FT1555-HH-K2

Hand held electric heat gun starter kit

- Typical applications – Hose shops and mobile hose fabricators
- Capsules fit and seal hose and tube fittings from .55" OD (14mm) through 1.73" OD (44mm)
- FT1555-1824UP CapSeal Capsules 18mm x 24mm (ID x LENGTH)
- FT1555-2030UP CapSeal Capsules 20mm x 30mm (ID x LENGTH)
- FT1555-2540UP CapSeal Capsules 25mm x 40mm (ID x LENGTH)
- FT1555-2840UP CapSeal Capsules 28mm x 40mm (ID x LENGTH)
- FT1555-3140UP CapSeal Capsules 31mm x 40mm (ID x LENGTH)
- FT1555-3440UP CapSeal Capsules 34mm x 40mm (ID x LENGTH)
- FT1555-3840UP CapSeal Capsules 38mm x 40mm (ID x LENGTH)
- FT1555-4650UP CapSeal Capsules 46mm x 50mm (ID x LENGTH)



FT1555-HH-K3

Hand held electric heat gun premium starter kit

- Typical applications – Hose shops and mobile hose fabricators
- Capsules fit and seal hose and tube fittings from .55" OD (14mm) through 3.07" OD (78mm)
- FT1555-1824UP CapSeal Capsules 18mm x 24mm (ID x LENGTH)
- FT1555-2030UP CapSeal Capsules 20mm x 30mm (ID x LENGTH)
- FT1555-2540UP CapSeal Capsules 25mm x 40mm (ID x LENGTH)
- FT1555-2840UP CapSeal Capsules 28mm x 40mm (ID x LENGTH)
- FT1555-3140UP CapSeal Capsules 31mm x 40mm (ID x LENGTH)
- FT1555-3440UP CapSeal Capsules 34mm x 40mm (ID x LENGTH)
- FT1555-3840UP CapSeal Capsules 38mm x 40mm (ID x LENGTH)
- FT1555-4650UP CapSeal Capsules 46mm x 50mm (ID x LENGTH)
- FT1555-5260UP CapSeal Capsules 52mm x 60mm (ID x LENGTH)
- FT1555-5860UP CapSeal Capsules 58mm x 60mm (ID x LENGTH)
- FT1555-6760UP CapSeal Capsules 67mm x 60mm (ID x LENGTH)
- FT1555-8060UP CapSeal Capsules 80mm x 60mm (ID x LENGTH)

Contamination control

FT1555 CapSeal system

Capsules

FT1555 CapSeal capsules eliminate contamination by forming a clean and secure seal around hose and tube ends. FT1555 CapSeal system eliminates the need to stock multiple plastic threaded caps with just 19 CapSeal capsule sizes to meet all type of hose and tube end configurations.

Additionally, the quick and easy pull-off tab on each capsule eliminates the need for additional tools that could further contaminate the assemblies.

FT1555 CapSeal capsules are available in 19 sizes of varying diameter and length to match needs of all assemblies, and are available in both unit packaged and bulk packaged packaging.

Unit packaged CapSeal packages		Bulk packaged CapSeal packages	CapSeal capsule size	Hex sizes covered		Fitting		
CapSeal part #		CapSeal part #	Packaged quantity	(mm, ID X length)	(mm)	(Inches)	Straight	Elbow*
FT1555-1424UP	960	FT1555-1424BP	12,320	14x24	10mm to 13mm	.39" to .51"	x	X
FT1555-1624UP	840	FT1555-1624BP	9,000	16x24	12mm to 15mm	.47" to .59"	X	x
FT1555-1824UP	840	FT1555-1824BP	7,360	18x24	14mm to 17mm	.55" to .67"	X	x
FT1555-2023UP	810	FT1555-2023BP	23,400	20 X 23	12mm to 18mm	0.47" to 0.71"		X
FT1555-2030UP	810	FT1555-2030BP	23,400	20 X 30	12mm to 18mm	0.47" to 0.71"	X	
FT1555-2224UP	810	FT1555-2224BP	22,500	22 X 24	16mm to 21mm	0.63" to 0.63"		X
FT1555-2527UP	800	FT1555-2527BP	17,600	25 X 27	18mm to 23mm	0.71 to 0.91"		X
FT1555-2540UP	800	FT1555-2540BP	17,600	25 X 40	18mm to 23mm	0.71" to 0.91"	X	
FT1555-2840UP	720	FT1555-2840BP	15,200	28 X 40	22mm to 26mm	0.87" to 1.02"	X	
FT1555-3133UP	640	FT1555-3133BP	12,240	31 X 33	24mm to 29mm	0.94" to 1.14"		X
FT1555-3140UP	640	FT1555-3140BP	12,240	31 X 40	24mm to 29mm	0.95" to 1.14"	X	
FT1555-3440UP	640	FT1555-3440BP	10,240	34 X 40	27mm to 32mm	1.07" to 1.26"	X	
FT1555-3840UP	560	FT1555-3840BP	7,800	38 X 40	30mm to 36mm	1.19" to 1.42"	X	X
FT1555-4345UP	480	FT1555-4345BP	6,240	43 X 45	32mm to 41mm	1.26" to 1.61"	X	X
FT1555-4650UP	480	FT1555-4650BP	5,760	46 X 50	34mm to 44mm	1.34" to 1.73"	X	X
FT1555-5260UP	400	FT1555-5260BP	4,400	52 X 60	41mm to 50mm	1.62" to 1.97"	X	X
FT1555-5860UP	400	FT1555-5860BP	3,600	58 X 60	49mm to 56mm	1.93" to 2.20"	X	X
FT1555-6760UP	320	FT1555-6760BP	2,560	67 X 60	55mm to 65mm	2.16" to 2.56"	X	X
FT1555-8060UP	320	FT1555-8060BP	1,736	80 X 60	64mm to 78mm	2.52" to 3.07"	X	X

* Shorter length CapSeal capsules are recommended for elbow and angled fittings (45° and 90°)

FT1555 CapSeal system

Accessories



FT1555-HH-AK15

1-1/2" connection

- 110mm air knife to shrink CapSeal capsules
- Accommodates all CapSeal capsules



FT1555-HH-AK20

2" connection

- 110mm air knife to shrink CapSeal capsules
- Accommodates all CapSeal capsules



Magnetic Puck

FT1555-LMP- Large magnetic puck

FT1555-SMP- Small magnetic puck

Magnetic puck pulls nut forward on hose or tube assemblies to allow proper sealing while being placed in air knife.

Aeroquip by Danfoss

Danfoss branded cabinets & storage



Danfoss branded cabinets & storage

Organize your inventory

Danfoss branded stocking cabinets are the ideal way to organize your inventory of Danfoss hose ends, adapters, hoses and assembly tooling.



C-40X

The sturdy C-40X cabinet contains 40 heavy-duty drawers that can be divided into two, three, or four compartments providing space for a large selection of hose ends and adapters. It has mounting holes for the T-420, ET1187, and ET1000 crimp machines.

46-1/2"H x 40"W;
26" Deep at base, 18" Deep at top.
228 lbs.



C-15X

The rugged C-15X contains 15 extra large drawers that may be divided into two or three sections for those large, difficult to store items.

13 -5/8"H x 30 -1/4"W; 14-3/8" Deep.
45 lbs.



C-63X

This stock cabinet containing 63 drawers, which can be divided into two or three sections, is a nice addition to any store front.

25"H x 30 -1/4"W; 9-1/4" Deep.
61 lbs.



FC-16X

The FC-16X contains 16 clear poly drawers that can be divided into two or three sections.

11-3/4"H x 16 -1/8"W; 9" Deep.
13 lbs.



FH-135X

The sturdy FH-135X cabinet contains 50 heavy-duty drawers that can be divided into one, two, or three compartments allowing ample space for a large selection of hose ends and adapters. It includes mounting holes for the ET1187 and ET1000 crimp machines.

46-1/2"H x 33" W; 14-1/2" Deep.
115 lbs.

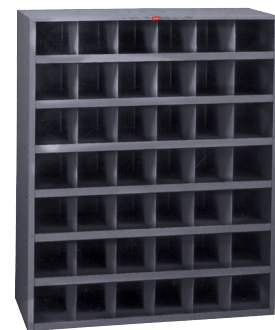

FH-40X

Provides convenient storage areas for those large size fittings and hose ends. This durable 20 gauge steel cabinet is made to handle abuse

35" wide, 42" high, 12" deep
200 lbs.

NOTE: Will not support crimp equipment.

Danfoss branded cabinets & storage



C-632X

The C-632X consists of the CB-63X cabinet base, the C-15X cabinet, and two C-63X cabinets. This cabinet is a space saving, efficient addition to the modern store with a lobby type sales area. It requires a minimum amount of space, but does a maximum job merchandising a wide variety of products in 126 clear drawers. An additional 15 large, high impact drawers located in the bottom section provide ample space for large or heavy items.

68-1/2"H x 30" W; 15" Deep.
Weight: 167 lbs.



HD-1X

The HD-1X cabinet offers the ideal solution for keeping 50-foot lengths of hose off the floor. Vertical slots in the cabinet keep hoses organized and clean. Consider bolting a C-15X stocking cabinet on top of the HD-1X to keep an inventory of hose ends readily available. Internal dimensions have changed from 7 narrow 4.3" sections to 5 wider 6.14" sections to accommodate larger hose sizes

36"H x 31" W; 24" Deep.
83 lbs.



HD-2X

The HD-2X hose display is designed to support the weight of Danfoss bulk reels and boxed product.

22" wide x 30" deep x 57" tall
54 pounds
3 Reels or 2 Reels with 4 boxes

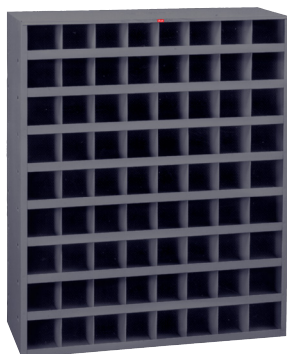

FH-72X

Large capacity all-welded cabinet provides 72 storage compartments. Fabricated from 20 gauge steel, the FH-72X will provide years of continued service.

35" wide, 42" high, 12" deep
200 lbs.

NOTE: Will not support crimp equipment.



FT1380DR-12

The lazy susan die cage rack offers easy 360-degree access to 12 of your FT1380 series crimp dies.

18" wide, 10" high, 6" deep
50 lbs.



TC-20

The TC-20 cabinet provides easy access to all your tooling needs. This collet cabinet fits Danfoss' core tooling products. Standard holes fit the ET425 series collets. Inserts are provided to fit the ET313 series collets

28-1/2"H x 26-1/2" W; 12-3/4" Deep.
37.5 lbs.

Replacement drawers/dividers and label sets

Replacement drawers/dividers

All drawers are clear polypropylene and
all dividers are black polypropylene

Replacement drawers/dividers	
Part #	Description
PD-15	Divider for the FH-135X and C-15X
PD-49	Drawer for the C-63X and FC-16X
PD-75SET	Divider for the C-63X and FC-16X (pack of 14)
PD-95	Drawer for the FH-135X
CD-15	Drawer for the C-15X
PD-20	Divider for the C-40X
PD-40	Drawer for the C-40X

Self adhesive label sets

For C-40X, C-15X, and FH-135X cabinets

Self adhesive label sets	
Label #	Description
FF00000	Blank label sheet (8.5 X 11 blank bin label pages supporting up to 46 labels each)
FF17266	1A/TTC series hose ends label set
FF17266-NOBC	1A/TTC series hose ends label set (without barcode)
FF90645	Z series hose ends label set
FF90645-NOBC	Z series hose ends label set (without barcode)
FF90646	E-Z Clip label set
FF91420	4S/6S series hose ends label set
FF91420-NOBC	4S/6S series hose ends label set (without barcode)
FF91475	Core positive stop style tooling label set
FF91475-NOBC	Core positive stop style tooling label set (without barcode)
FF91610	4TA series hose ends label set
FF91610-NOBC	4TA series hose ends label set (without barcode)

Aeroquip by Danfoss

Safety information



Important Safety Information

Safety Information

Danfoss Aeroquip Hose and Fitting Assembly Product Warning

Flexible hose lines offer many advantages over rigid tubing including routing ease, vibration absorption, sound deafening and the ability to accommodate movement of connected components. However, hose lines require caution in use not only to provide long service, but also to guard against potentially dangerous failure.

The user should carefully observe the precautions listed in this catalog, including the recommendations on the selection of hose and fittings on the relevant pages, and the pages on fluid compatibility. In addition, care should be taken not to exceed the minimum bend radius listed for each hose size and type in the hose section. Maximum operating pressure should not exceed pressures listed in the hose data. Instructions for assembling fittings to different hose should be followed carefully to ensure the performance of the completed assembly.

WARNING

Danfoss fitting tolerances are engineered to match Danfoss' Aeroquip hose tolerances. The use of Danfoss fittings on hose supplied by other manufacturers and/or the use of Danfoss' Aeroquip hose with fittings supplied by other manufactures may result in the production of unreliable and unsafe hose assemblies and is neither recommended nor authorized by Danfoss or any of its affiliates or subsidiaries.

WARNING

Application considerations must be observed in selecting appropriate components for the application of these products contained herein. The failure to follow the recommendations set forth in this catalog may result in an unstable application which may result in serious personal injury or property damage.

DANFOSS OR ANY OF ITS AFFILIATES OR SUBSIDIARIES SHALL NOT BE SUBJECT TO AND DISCLAIMS ANY OBLIGATIONS OR LIABILITIES (INCLUDING BUT NOT LIMITED TO ALL CONSEQUENTIAL, INCIDENTAL AND CONTINGENT DAMAGES) ARISING FROM TORT CLAIMS (INCLUDING WITHOUT LIMITATION NEGLIGENCE AND STRICT LIABILITY) OR OTHER THEORIES OF LAW WITH RESPECT TO ANY HOSE ASSEMBLIES NOT PRODUCED FROM GENUINE AEROQUIP HOSE FITTINGS, HOSE AND AEROQUIP APPROVED EQUIPMENT, AND IN CONFORMANCE WITH DANFOSS' AEROQUIP PROCESS AND PRODUCT INSTRUCTIONS FOR EACH SPECIFIC HOSE ASSEMBLY.

Failure to follow these processes and product instructions and limitations could lead to premature hose assembly failures resulting in property damage, serious injury or death.

If the user follows the recommendations on hose line routing and installation as provided herein, improved safety and longer service life of any hose installation will result.

Proper installation of the hose is essential to the proper operation and safe use of the hose and related equipment. Improper installation of the hose can result in serious injury or property damage caused by spraying fluids or flying projectiles. In order to avoid serious bodily injury or property damage resulting from improper installation of the hose, you should carefully review the information in this catalog regarding hose installation.

Some of the factors you must consider in installing the hose properly are:

- Changes in length
- Proper bend radius
- Protection from high temperature sources
- Elbows and adapters to relieve strain
- Rubbing or abrasion
- Twisting
- Improper hose movement

These factors and the other information in this catalog regarding hose installation should be considered by you before installing the hose. If you have any questions regarding proper hose installation, please contact Danfoss Technical Support at 1-888-258-0222.

Proper maintenance of the hose is essential to the safe use of the hose and related equipment. Hose should be stored in a dry place. Hose should also be visually inspected. Any hose that has a cut or gouge in the cover that exposes the reinforcement should be retired from service. Hoses should also be inspected for kinking or broken reinforcement. If the outside diameter of the hose is reduced by 20% at the spot where it is bent then the hose should be retired from service. Inadequate attention to maintenance of the hose can result in hose leakage, bursting, or other failure which can cause serious bodily injury or property damage from spraying fluids, flying projectiles, or other substances.

Selection, installation and maintenance of hose and assemblies

The following recommendations on selection, installation and maintenance of hose assemblies were established in SAE J1273. Please read these general instructions carefully. More detailed information on many of these subjects is covered in this catalog.

Hose (also includes hose assemblies) has a finite life and there are a number of factors which will reduce its life. This recommended practice is intended as a guide to assist system designers and/or users in the selection, installation, and maintenance of hose.

The designers and users must make a systematic review of each application and then select, install, and maintain the hose to fulfill the requirements of the application. The following are general guidelines and are not necessarily a complete list.

WARNING

Improper selection, installation, or maintenance may result in premature failures, bodily injury, or property damage.

2.1 Applicable documents

The following publications form a part of this specification to the extent specified herein. The latest issue of SAE publications shall apply.

2.1.1 SAE publications

Available from SAE,
400 Commonwealth Drive, Warrendale, PA
15096-0001.
J516—Hydraulic hose fittings
J517—Hydraulic hose

The following is a list of factors which must be considered before final hose selection can be made.

3.1 Pressure

After determining the system pressure, hose selection must be made so that the recommended maximum operating pressure is equal to or greater than the system pressure. Surge pressures higher than the maximum operating pressure will shorten hose life and must be taken into account by the hydraulic designer.

3.2 Suction

Hoses used for suction applications must be selected to insure the hose will withstand the negative pressure of the system.

3.3 Temperature

Care must be taken to insure that fluid and ambient temperatures, both static and transient, do not exceed the limitations of the hose. Special care must be taken when routing near hot manifolds.

3.4 Fluid compatibility

Hose selection must assure compatibility of the hose tube, cover and fittings with the fluid used. Additional caution must be observed in hose selection for gaseous applications.

3.5 Size

Transmission of power by means of pressurized fluid varies with pressure and rate of flow. The size of the components must be adequate to keep pressure losses to a minimum and avoid damage to the hose due to heat generation or excessive turbulence.

3.6 Routing

Attention must be given to optimum routing to minimize inherent problems.

3.7 Environment

Care must be taken to insure that the hose and fittings are either compatible with or protected from the environment to which they are exposed. Environmental conditions such as ultraviolet light, ozone, salt water, chemicals, and air pollutants can cause degradation and premature failure and, therefore, must be considered.

3.8 Mechanical loads

External forces can significantly reduce hose life. Mechanical loads which must be considered include excessive flexing, twist, kinking, tensile or side loads, bend radius, and vibration. Use of swivel-type fittings or adapters may be required to insure no twist is put into the hose. Unusual applications may require special testing prior to hose selection.

3.9 Abrasion

While hose is designed with a reasonable level of abrasion resistance, care must be taken to protect the hose from excessive abrasion which can result in erosion, snagging and cutting of the hose cover. Exposure of the reinforcement will significantly accelerate hose failure.

3.10 Proper end fitting

Care must be taken to insure proper compatibility exists between the hose and coupling selected based on the manufacturer's recommendations substantiated by testing to industry standards such as SAE J517. End fitting components from one manufacturer are usually not compatible with end fitting components supplied by another manufacturer (i.e., using a hose fitting nipple from one manufacturer with a hose socket from another manufacturer). It is the responsibility of the fabricator to consult the manufacturer's written instructions or the manufacturer directly for proper end fitting componentry.

3.11 Length

When establishing proper hose length, motion absorption, hose length changes due to pressure, as well as hose and machine tolerances must be considered.

3.12 Specifications and standards

When selecting hose, government, industry and manufacturers' specifications and recommendations must be reviewed as applicable.

3.13 Hose cleanliness

Hose components vary in cleanliness levels. Care must be taken to insure that the assemblies selected have an adequate level of cleanliness for the application.

3.14 Electrical conductivity

Certain applications require that hose be nonconductive to prevent electrical current flow. Other applications require the hose to be sufficiently conductive to drain off static electricity. Hose and fittings must be chosen with these needs in mind.

After selection of proper hose, the following factors must be considered by the installer.

4.1 Pre-installation inspection

Prior to installation, a careful examination of the hose must be performed. All components must be checked for correct style, size and length. In addition, the hose must be examined for cleanliness, I.D. obstructions, blisters, loose cover, or any other visible defects.

General hose selection information

Selection, installation and maintenance of hose and assemblies

The following recommendations on selection, installation and maintenance of hose assemblies were established in SAE J1273. Please read these general instructions carefully. More detailed information on many of these subjects is covered in this catalog.

4.2 Follow manufacturers' assembly instructions

Hose assemblies may be fabricated by the manufacturer, an agent for or customer of the manufacturer, or by the user. Fabrication of permanently attached fittings to hydraulic hose requires specialized assembly equipment. Field attachable fittings (screw style and segment clamp style) can usually be assembled without specialized equipment although many manufacturers provide equipment to assist in the operation.

SAE J517 hose from one manufacturer is usually not compatible with SAE J516 fittings supplied by another manufacturer. It is the responsibility of the fabricator to consult the manufacturer's written assembly instructions or the manufacturer's directly before intermixing hose and fittings from two manufacturers. Similarly, assembly equipment from one manufacturer is usually not interchangeable with that of another manufacturer. It is the responsibility of the fabricator to consult the manufacturer's written instructions or the manufacturer directly for proper assembly equipment. Always follow the manufacturer's instructions for proper preparation and fabrication of hose assemblies.

4.3 Minimum bend radius

Installation at less than minimum bend radius may significantly reduce hose life. Particular attention must be given to preclude sharp bending at the hose/fitting juncture.

4.4 Twist angle and orientation

Hose installations must be such that relative motion of machine components produces bending of the hose rather than twisting.

4.5 Securement

In many applications, it may be necessary to restrain, protect, or guide the hose to protect it from damage by unnecessary flexing, pressure surges, and contact with other mechanical components. Care must be taken to insure such restraints do not introduce additional stress or wear points.

4.6 Proper connection of ports

Proper physical installation of the hose requires a correctly installed port connection while insuring that no twist or torque is put into the hose.

4.7 Avoid external damage

Proper installation is not complete without insuring that tensile loads, side loads, kinking, flattening, potential abrasion, thread damage, or damage to sealing surfaces are corrected or eliminated.

4.8 System check out

After completing the installation, all air entrapment must be eliminated and the system pressurized to the maximum system pressure and checked for proper function and freedom from leaks.

NOTE: Avoid potential hazardous areas while testing.

Even with proper selection and installation, hose life may be significantly reduced without a continuing maintenance program. Frequency should be determined by the severity of the application and risk potential. A maintenance program should include the following as a minimum.

5.1 Hose storage

Hose products in storage can be affected adversely by temperature, humidity, ozone, sunlight, oils, solvents, corrosive liquids and fumes, insects, rodents and radioactive materials. Storage areas should be relatively cool and dark and free of dust, dirt, dampness and mildew.

5.2 Visual inspection

Any of the following conditions requires replacement of the hose: Leaks at fitting or in hose (leaking fluid is a fire hazard). Damaged, cut, or abraded cover (any reinforcement exposed) Kinked, crushed, flattened, or twisted hose Hard, stiff, heat cracked or charred hose Blistered, soft, degraded, or loose cover Cracked, damaged, or badly corroded fittings Fitting slippage on hose

5.3 Visual inspection

The following items must be tightened, repaired, or replaced as required:

Leaking port conditions

Clamps, guards, shields

Remove excessive dirt buildup

System fluid level, fluid type, and any air entrapment

5.4 Functional test

Operate the system at maximum operating pressure and check for possible malfunctions and freedom from leaks.

NOTE: Avoid potential hazardous areas while testing.

5.5 Replacement intervals

Specific replacement intervals must be considered based on previous service life, government or industry recommendations, or when failures could result in unacceptable down time, damage, or injury risk.

How to order

Accurate processing and prompt delivery of your order depends on easy identification of your requirements. Please order Aeroquip brand parts using correct part numbers as described in this catalog. Inquiries and orders should be directed to your Aeroquip distributor or:

Dash size designates the nominal size in 16th of an inch. This number immediately follows the part number and is separated from it with a dash.

Dimensions given in this catalog for Aeroquip products are approximate and should be used for reference only. Exact dimensional information for a given product is subject to change and varying tolerances; contact Danfoss directly for full current information.

WARNING

Hose assemblies

Danfoss manufactures the terminal ends of our hose fittings to the appropriate requirements established by the SAE. Therefore, the performance ratings of these hose fittings meet the SAE requirements. It is possible to order a hose assembly with a fitting terminal end that has a performance rating lower than the hose rating. When ordering hose assemblies, please keep the connecting end performance rating in mind since this may affect overall hose assembly performance. Hose assembly components (hose and fittings) are easily assembled in the field. However, factory assembled field attachable and crimped hose assemblies are available. For complete information, contact Danfoss.

Hose selection: Flow capacities

Flow capacities of hose assemblies at suggested flow velocities

The chart below is designed and provided as an aid in the determination of the correct hose size.

At 13 U.S. gallons per minute, what is proper hose size within the suggested velocity range for pressure lines?

Locate 13 U.S. gallons per minute in the left hand column and 10 feet per second in the right hand column (the center of the suggested velocity range for pressure lines). Lay a straightedge across the two points. The inside diameter is shown in the center column nearest the straight edge.

For suction hose, follow the same procedure except use suggested velocity range for pump inlet lines in the right hand column.

$$\text{Area (sq. in.)} = \frac{\text{G.P.M.} \times 0.3208}{\text{Velocity (FT./SEC.)}}$$

* Suggestions are for oils having a maximum viscosity of 315 S.S.U. at +100°F (+38°C) and operating at temperatures between +65°F and +155°F (+54°C to +69°C). Under certain conditions, velocities in pressure lines can be increased up to 25 feet per second. Contact Aeroquip® with specific information on your application.

To convert U.S. gallons into Imperial gallons multiply U.S. gallons by 0.83267. Imperial gallons into U.S. gallons multiply Imperial gallons by 1.20095. U.S. gallons to liters multiply by 3.785. Liters to U.S. gallons, multiply by 0.2642.

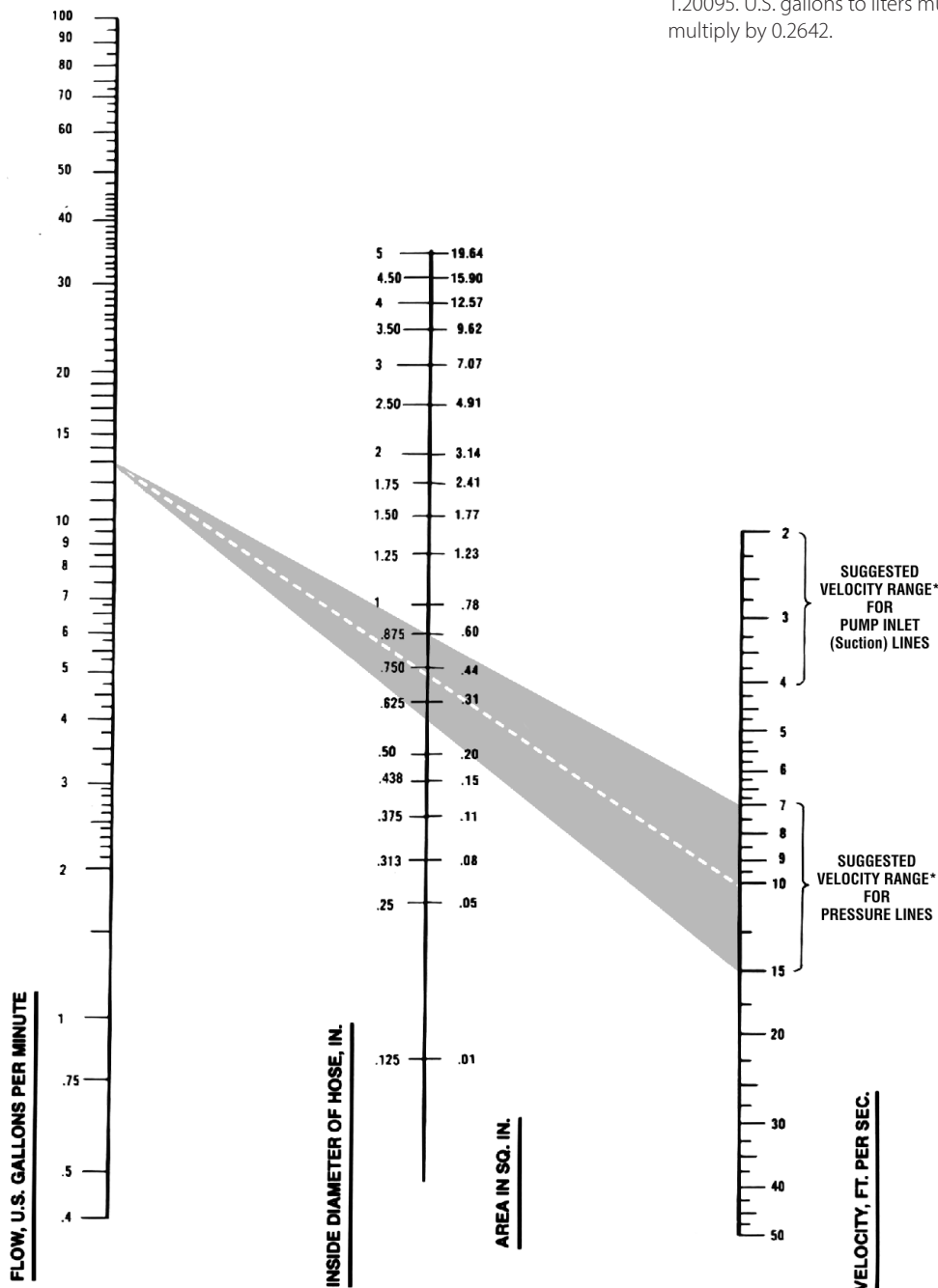

Flow capacities pressure drop

Pressure drop in psi (pounds per square inch)/ gpm (gallons per minute) for 10 feet of hose (smooth bore) without fittings.

Fluid specification:
Specific gravity = 0.85;
Viscosity = ν =
20 centistokes (C.S.),
(20 C.S. = 97 S.S.U.).

Hose pressure drop																						
Hose dash size	-04		-05		-06		-08		-10		-12		-16		-20		-24		-32		-40	-48
Hose I.D. (inches)	0.19	0.25	0.25	0.31	0.31	0.38	0.41	0.50	0.50	0.63	0.63	0.75	0.88	1.00	1.13	1.25	1.38	1.50	1.81	2.00	2.38	3.00
0.25	10	3.1	3.1	-	-	-	-	-	-	-	-	-	-	-	-	-	-	-	-	-	-	-
0.50	19	6	6	2.7	2.7	-	-	-	-	-	-	-	-	-	-	-	-	-	-	-	-	-
1	40	12	12	5.5	5.5	2.4	-	-	-	-	-	-	-	-	-	-	-	-	-	-	-	-
2	95	24	24	10	10	4.8	3.5	-	-	-	-	-	-	-	-	-	-	-	-	-	-	-
3	185	46	46	17	17	7	5	2.2	2.2	-	-	-	-	-	-	-	-	-	-	-	-	-
4	-	78	78	29	29	12	8	3	3	1.2	1.2	-	-	-	-	-	-	-	-	-	-	-
5	-	120	120	44	44	18	12	4.5	4.5	1.6	1.6	0.72	-	-	-	-	-	-	-	-	-	-
8	-	-	-	95	95	39	26	10	10	3.6	3.6	1.4	0.60	-	-	-	-	-	-	-	-	-
10	-	-	-	-	-	59	40	15	15	5.7	5.7	2	1	0.55	-	-	-	-	-	-	-	-
12	-	-	-	-	-	80	52	20	20	7.2	7.2	2.6	1.5	0.75	0.43	-	-	-	-	-	-	-
15	-	-	-	-	-	-	75	30	30	10	10	4.2	2.2	1.2	0.67	0.38	-	-	-	-	-	-
18	-	-	-	-	-	-	107	40	40	15	15	6.3	3	1.5	0.70	0.55	0.35	-	-	-	-	-
20	-	-	-	-	-	-	-	49	49	19	19	8	3.4	2	1.1	0.65	0.43	0.27	-	-	-	-
25	-	-	-	-	-	-	-	72	72	26	26	11	5.5	3	1.6	1	0.64	0.40	0.17	-	-	-
30	-	-	-	-	-	-	-	-	-	34	34	14	7	3.6	2.2	1.3	0.80	0.52	0.22	0.14	-	-
35	-	-	-	-	-	-	-	-	-	47	47	19	9.5	5	2.8	1.7	1.1	0.70	0.27	0.18	-	-
40	-	-	-	-	-	-	-	-	-	-	-	25	12	6.5	3.4	2.2	1.4	0.90	0.38	0.24	-	-
50	-	-	-	-	-	-	-	-	-	-	-	36	17	9	5.3	3.3	2	1.3	0.54	0.35	0.15	-
60	-	-	-	-	-	-	-	-	-	-	-	50	23	12	7.5	4.4	2.8	1.8	0.75	0.45	0.20	-
70	-	-	-	-	-	-	-	-	-	-	-	-	31	17	9.3	6	3.8	2.4	1	0.65	0.30	-
80	-	-	-	-	-	-	-	-	-	-	-	-	38	21	12	7.1	4.6	3	1.2	0.76	0.34	0.11
90	-	-	-	-	-	-	-	-	-	-	-	-	49	27	15	9	5.9	3.8	1.5	1	0.45	0.13
100	-	-	-	-	-	-	-	-	-	-	-	-	-	33	19	12	7	4.7	1.9	1.3	0.55	0.18
150	-	-	-	-	-	-	-	-	-	-	-	-	-	60	36	22	13	8.5	3.4	2.2	1	0.33
200	-	-	-	-	-	-	-	-	-	-	-	-	-	-	-	36	23	15	6	3.9	1.7	0.55
250	-	-	-	-	-	-	-	-	-	-	-	-	-	-	-	54	33	22	8.5	5.3	2.5	0.75
300	-	-	-	-	-	-	-	-	-	-	-	-	-	-	-	-	45	29	12	7.5	4	1.1
400	-	-	-	-	-	-	-	-	-	-	-	-	-	-	-	-	-	51	21	14	6.5	2.2
500	-	-	-	-	-	-	-	-	-	-	-	-	-	-	-	-	-	-	32	20	10	3
800	-	-	-	-	-	-	-	-	-	-	-	-	-	-	-	-	-	-	-	-	18	5
1000	-	-	-	-	-	-	-	-	-	-	-	-	-	-	-	-	-	-	-	-	-	10

* Pressure drop values listed are typical of many petroleum based hydraulic oils at approximately +100°F (+38°C). Differences in fluids, fluid temperature and viscosity can increase or decrease actual pressure drop compared to the values listed.

To convert

To convert U.S. gallons into Imperial gallons multiply U.S. gallons by 0.83267. Imperial gallons into U.S. gallons multiply Imperial gallons by 1.20095. U.S. gallons to litres multiply by 3.785. Litres to U.S. gallons, multiply by 0.2642.

Hose selection: hose fitting pressure charts

Thread style pressure performance

Danfoss closely follows industry standards in design and in application recommendations. A key principle within ISO, SAE and other standards bodies is that the **maximum dynamic working pressure of the hose or adapter assembly** is the lesser of the hose and end connector(s) used.

The first table below provides excerpts from standard industry pressure rating charts for connector types as published by SAE (Society of Automotive Engineers).

Note 1: The tables below are applicable for low carbon free machining steels typically used in Fluid Power connections. For port type connections, the material and design of the port must be considered and may reduce expected strength.

Note 2: For high pressure applications Danfoss recommends the use of more robust connector designs such as Code 62 flange or O-Ring face seal.

Note 3: Some Danfoss products have higher pressure ratings. Refer to the product page for specific pressure ratings.

Selected SAE pressure ratings

Dash size	Inch size	37°	Pipe SAE J476	Male ORB SAE J1926 ORS adapt.	Male ORB SAE J1926 non-ORS adapt.	Adjustable SAE J1926 ORS	Adjustable ORB non-ORS	ORS	Inverted flare	Code 61 Flange	Code 62 Flange
-2	1/8	5000	5000	-	5000	-	5000	-	5000	-	-
-3	3/16	5000	-	9000	5000	6000	5000	-	5000	-	-
-4	1/4	4500	5000	9000	5000	6000	4500	9000	4500	-	-
-5	5/16	4000	-	9000	5000	6000	4500	9000	4000	-	-
-6	3/8	4000	4000	9000	5000	6000	4000	9000	4000	-	-
-8	1/2	4000	3000	9000	4500	6000	4000	9000	4000	5000	6000
-10	5/8	3000	-	9000	3500	6000	3000	6000	3000	-	-
-12	3/4	3000	2500	6000	3500	6000	3000	6000	3000	5000	6000
-14	7/8	2500	-	6000	3000	6000	2500	6000	2500	-	-
-16	1	2500	2000	6000	3000	5000	2500	6000	2500	5000	6000
-20	1 1/4	2000	1150	4000	2500	4000	2000	3600	2000	4000	6000
-24	1 1/2	1500	1000	4000	2500	3000	2000	3600	1500	3000	6000
-32	2	1125	1000	3000	2000	2500	1500	3000	1125	3000	6000

Maximum working pressure (PSI)

Hose fitting connection	Hose fitting size									
	-04	-05	-06	-08	-10	-12	-16	-20	-24	-32
Male British Pipe (BSP)	5000	-	4000	4000	3500	4000	3500	2500	2,000	2000
Female British Pipe (BSP)	5000	-	4000	4000	3500	4000	3500	2500	2,000	2000
Female Pipe (JIS)	5000	-	5000	5000	-	4000	4000	-	-	-

Maximum working pressure (PSI)

Hose fitting Connection	Hose fitting size									
	-06	-08	-10	-12	-15	-18	-22	-28	-35	-42
DIN light	3625	3625	3625	3625	3625	2325	2325	1450	1450	1450

Hose fitting pressure charts

With higher pressures it is critical to know the construction materials and manufacturing method to ensure performance. When all components in a system are Danfoss supplied, for example an Danfoss hose fitting is mated

with an Danfoss adapter or tube fitting, the combination may be used at higher pressures with confidence. These higher ratings are noted in the chart below.

All Danfoss pressure ratings ¹													
Dash Size	Inch Size	37° JIC	Male Pipe	Female Pipe ²	Male ORB ORS Adapters	Male ORB Non-ORB Adapters	Adjustable ORB ORS Adapters	Adjustable ORB Non-ORB Adapters	ORB	Male Flareless Ermeto	Code 61	Code 62	STC
-2	1/8	-	10000	6000	-	5000	-	5000	-	5000	-	-	-
-3	3/16	-	-	-	9000	5000	6000	5000	-	5000	-	-	-
-4	1/4	7000	9500	5000	9000	5000	6000	4500	9000	4500	-	-	6000
-5	5/16	7000	-	-	9000	5000	6000	4500	-	4000	-	-	-
-6	3/8	5000	8000	4000	9000	5000	6000	4000	9000	4000	-	-	5000
-8	1/2	4000	6000	4000	9000	4500	6000	4000	9000	4000	5000	6000	4250
-10	5/8	3800	-	-	9000	3500	6000	3000	9000	3000	-	-	4000
-12	3/4	5000	5000	3500	6000	3500	6000	3000	6000	3000	5000	6000	4000
-14	7/8	-	-	-	6000	3000	6000	2500	-	2500	-	-	-
-16	1	5000	4000	3000	6000	3000	5000	2500	6000	2500	5000	6000	4000
-20	1 1/4	5000	3000	2000	4000	2500	4000	2000	4500	2000	4000	6000	-
-24	1 1/2	2100	2000	1500	4000	2500	3000	2000	4000	1500	3000	6000	-
-32	2	1750	2000	1500	3000	2000	2500	1500	3000	1125	3000	6000	-

1) These ratings are based on both brazed and one piece construction, one-piece pressures could be increased. Please contact Danfoss in these situations.

2) This rating is for thin walled adapters or fittings, the use of manifolds or oversized female ports would allow full rated male pressures.

Dynamic operating conditions refers to cyclic pressure impulses, usually considered to be from near zero to the highest system pressure. Hydraulic standards typically represent these as square waves and expect a component to handle on the order of 200,000 to well over one million such cycles with a burst: operating safety factor of 4:1. The above charts are created with dynamic applications in mind. Most industrial and mobile hydraulic systems fit the dynamic operating pressure profile, for example hydraulic work circuits on construction equipment or on injection molding equipment.

Static operating conditions typically range from zero to operating pressure, but with far fewer cycles expected for the system life – perhaps 30,000 to 50,000 cycles and sharp pressure spikes are not expected, allowing a burst: operating safety factor of 3:1 or less. For static operating conditions, the Danfoss ratings above can be safely increased by 25-30%. For example, a 3000 psi dynamic rated hose might be used in a 4000 psi static pressure application. Typical examples of static applications are water blast and hydraulic jacking.

The above tables represent performance using common low carbon steel material. Other materials and their characteristics influence these ratings. Medium carbon steels or heat treated materials can support higher working pressures. Conversely non-ferrous materials such as aluminum or brass will have reduced capability – as much as 50%, or less, pressure handling capability. It is important to consider material properties in designing a system to ensure pressure rating compatibility of all materials.

Danfoss' Fluid Conveyance engineering and support teams have many decades of experience in designing, manufacturing and servicing hydraulic and other fluid conveyance systems globally. Danfoss' product line is designed as a comprehensive collection of hose, fittings, connectors, couplings and accessories that allow a system designer to select components to complete a fluid power system or a service technician to replace a component with confidence. The individual product specifications, the above pressure ratings and other technical information are intended as supporting guidelines for system design and service needs and are not to be construed as a guarantee of performance of the system or of individual Danfoss components. Danfoss provides comprehensive technical support so please call with questions about pressure needs not covered by these charts or for specific application support.

Hose selection

Fluid compatibility

This chart indicates the suitability of various elastomers and metals for use with fluids to be conveyed. It is intended as a guide only and is not a guarantee. Final selection of the proper hose style, seal, or material of metal components is further dependent on many factors including pressure, fluid and ambient temperature, concentration, duration of exposure, etc.

1. The chart has separate sections for rating elastomers for use as hose inner tubes and as seals. Ratings for a given elastomer may not always be the same in both sections.
2. Both the elastomer and the metal must be considered when determining suitability of a combination for a hose assembly, adapter with o-ring, swivel joint or coupling.
3. Locate the fluid to be conveyed and determine the suitability of the elastomeric and metal components according to the resistance ratings shown for each.
4. Refer to the inner tube materials groupings under "Hose tube identification".
5. Dimensional and operating specifications for each hose can be found on the catalog pages shown with each hose part number.

6. Information on o-rings and seal options for swivel joints and couplings, and how to specify them, are shown in the respective sections of this catalog.
7. For further details on the products shown in this catalog, and their applications, contact:

- = Excellent – Fluid has little or no effect.
- = Good – Fluid has minor to moderate effect.
- = Conditional – Service conditions should be described to Danfoss Aeroquip for determination of suitability for application.
- = Unsatisfactory

The differences between ratings "E" and "G" are relative.

Both indicate satisfactory service. Where there is a choice, the materials rated "E" may be expected to give better or longer service than those rated "G".

NOTE: Special precautions are necessary in gaseous applications due to the potential volume of gaseous fluid in the system. Unless the cover is perforated, hose styles with rubber or thermoplastic covers are not suitable for gases above 250 psi. Hose styles with perforated covers are so noted in their construction descriptions.

WARNING

Compatibility of hose fittings with conveyed fluid is an essential factor in avoiding chemical reactions that may result in release of fluids or failure of the connection with the potential of causing severe personal injury or property damage.

Seal elastomer data

Seal elastomer		Max. operating temperature range
Buna-N†	none	-40°C to +121°C [-40°F to +250°F]
Neoprene	none	-54°C to +100°C [-65°F to +212°F]
EPR (Ethylene Propylene Rubber)/ EPDM	none	-54°C to +149°C [-65°F to +300°F]
Viton*		-29°C to +204°C [-15°F to +400°F]

†Buna-N temperature range -65°F to +225°F. Also per MIL-R-6855.

*Viton is a trademark of The Chemours Company FC, LLC.

1. Synthetic rubber
2. PTFE
3. Synflex thermoplastic elastomer
4. AQP
5. Special application hose (not included in fluid chart)
 - Fuel
 - LPG
 - Railroad air brake
 - Silicone
 - Truck air brake
 - A/C
6. EPDM rubber

The Fluid Compatibility chart is intended for reference use only.

The information in this chart pertains strictly to material compatibility and is not intended to be used as an application guide. For information on specific applications not included in this catalog, please contact Danfoss Aeroquip.

Note 1 - Rubber-covered hose must be perforated to allow gas to escape.

Note 2 - Due to the widely different additives in these fluids, testing should be done on the actual fluid being considered.

Fluid compatibility

This chart is intended for reference use only. The information in this chart pertains strictly to material compatibility and is not intended to be used as an application guide. For information on specific applications not included in this catalog, please contact Danfoss Aeroquip.

*Viton is a trademark of The Chemours Company FC, LLC.
 †Hytrell is a registered trademark of E.I. du Pont.
 ‡Monel is a registered trademark of Special Metals Corporation group of Companies.
 Note 1 - Rubber-covered hose must be perforated to allow gas to escape.
 Note 2 - Due to the widely different additives in these fluids, testing should be done on the actual fluid being considered.

Fluid	Hose						Seals						Metal					
	Synthetic rubber (Nitrile)		Thermoplastic elastomer		Special application hose		Buna-N	Neoprene	EPR	Viton*	Urethane	Hytrell†	Steel	Brass	Stainless steel	Aluminum	Monel‡	
	1	2	3	4	5	6												
Butyl cellosolve	U	E	U	U	-	E	U	U	G	U	U	C	E	E	E	E	E	
Butylene (butene) ¹	C	E	-	C	-	U	C	U	U	E	U	-	E	E	E	E	E	
Butyl stearate	U	E	-	U	-	U	G	U	U	E	-	-	G	G	G	G	G	
Butyraldehyde	U	E	-	U	-	E	U	U	G	U	U	-	E	E	E	E	G	
	G	E	C	C	-	E	G	G	E	U	U	C	G	G	G	C	G	
Calcium bisulfate, 10% aq	U	E	C	G	-	U	E	E	U	E	G	G	U	C	C	U	U	
Calcium chloride, 10% aq	E	E	E	C	-	E	E	E	E	E	E	E	G	G	G	C	G	
Calcium hydroxide, 10% aq	E	E	C	C	-	E	E	E	E	U	C	G	G	G	U	G		
Calcium hydroxide, 10% aq	C	E	C	U	-	E	U	U	E	E	U	C	U	G	C	U	U	
Calcium nitrate, 10% aq	E	E	E	G	-	E	E	E	E	E	E	E	G	G	G	G	G	
Carbitol	G	E	G	C	-	G	G	G	G	U	G	E	E	E	E	E	E	
Carbolic acid (phenol)	U	E	U	U	-	C	U	U	G	E	U	U	U	E	E	-	-	
Carbonic acid	C	E	C	U	-	E	G	E	E	C	C	U	C	E	G	E		
Carbon dioxide, dry gas ¹	E	E	E	E	-	E	G	G	E	E	G	E	E	E	E	E	E	
Carbon disulfide	U	E	U	U	-	U	U	U	E	C	C	G	G	G	E	G		
Carbon monoxide ¹	E	E	E	E	-	E	G	G	E	E	G	E	E	E	E	E	E	
Carbon tetrachloride	U	E	U	U	-	U	U	U	E	U	U	U	G	G	U	E		
Castor oil	E	E	G	E	-	G	E	E	G	E	G	G	E	E	E	E	E	
Cellosolve acetate	U	E	U	U	-	E	U	U	G	U	U	U	U	E	G	E		
China wood oil (tung Oil)	E	E	C	C	-	U	G	G	U	E	U	C	E	G	E	E	E	
Chlorine ¹	U	G	U	U	-	U	U	U	U	G	U	U	C	C	C	C	C	
Chloroacetic acid	U	E	U	U	-	E	U	U	G	U	U	U	U	U	U	U	G	

- = Excellent – Fluid has little or no effect.
- = Good – Fluid has minor to moderate effect.
- = Conditional – Service conditions should be described to Danfoss Aeroquip for determination of suitability for application.
- = Unsatisfactory

Fluid	Hose						Seals						Metal					
	Synthetic rubber (Nitrile)		Thermoplastic elastomer		Special application hose		Buna-N	Neoprene	EPR	Viton*	Urethane	Hytrell†	Steel	Brass	Stainless steel	Aluminum	Monel‡	
	1	2	3	4	5	6												
Chloroacetone	U	E	U	U	-	E	U	U	E	U	U	U	G	G	G	U	G	
Chlorobenzene	U	E	U	U	-	U	U	U	G	U	U	U	G	G	G	G	G	
Chloroform	U	E	U	U	-	U	U	U	E	U	U	U	G	G	G	G	G	
O-Chlorophenol	U	E	U	U	-	U	U	U	E	U	U	U	G	G	G	U	G	
Chlosulfonic acid	U	U	U	U	-	U	U	U	U	U	U	U	G	U	G	G	C	
Chrome plating solution	U	E	-	U	-	U	U	U	G	E	U	-	C	U	U	U	U	
	U	E	-	U	-	C	U	U	C	E	U	-	C	U	U	U	U	
Citric acid	G	E	C	G	-	E	E	E	E	E	E	C	C	C	C	C	C	
Coke oven gas	U	E	-	U	-	U	U	U	E	U	-	E	C	E	U	U		
Copper chloride, 10% aq	E	E	E	G	-	E	E	E	E	E	G	E	U	U	U	U	U	
Copper cyanide, 10% aq	E	E	-	G	-	E	E	E	E	E	-	E	U	G	U	G		
Copper sulfate, 10% aq	E	E	G	G	-	E	E	E	E	E	G	G	U	C	G	U	G	
Cotton seed Oil	E	E	E	G	-	C	E	G	C	E	E	E	E	E	E	E	E	
Creosote (coal tar)	G	E	U	G	-	U	G	C	U	E	U	U	E	C	E	E	E	
Crude oil	G	E	C	E	-	U	E	G	U	E	G	C	G	U	G	U	U	
Cyclohexanol	C	E	C	G	-	U	E	G	U	E	C	C	E	E	E	C	E	
Cyclohexanone	U	E	C	U	-	G	U	U	G	U	G	G	E	E	E	C	E	
	E	E	C	G	-	E	E	E	E	E	C	C	G	E	E	E	E	
Diacetone alcohol (acetol)	U	E	U	U	-	E	U	U	E	U	C	C	E	E	E	E	E	
Dibenzyl ether	U	E	-	U	-	G	U	U	G	U	-	-	G	G	G	G	G	
Diesel oil ²	G	E	C	G	-	U	E	C	U	E	C	C	E	E	E	E	E	
Diethylamine	C	E	-	C	-	C	G	G	G	U	-	-	E	U	E	-	E	
Diocetyl phthalate (DOP)	U	E	C	C	-	G	U	U	G	G	C	C	E	E	E	E	E	
Dowtherm A&E	U	E	-	U	-	U	U	U	U	E	-	-	G	U	E	E	E	
	E	E	C	G	-	E	E	E	E	E	C	C	E	E	E	G	E	
Ethyl acetate	U	E	C	U	-	G	U	U	G	U	C	C	E	E	E	E	E	
Ethyl benzene	U	E	-	U	-	U	U	U	E	U	-	E	G	G	G	E		
Ethyl cellulose	G	E	U	U	-	G	G	G	G	U	C	C	E	G	G	G	G	
Ethyl chloride	C	E	U	U	-	U	U	U	E	U	U	E	E	E	G	G		
Ethylene dichloride	U	E	U	U	-	U	U	U	G	U	U	G	C	G	G	G		
Ethylene glycol	E	E	C	G	-	E	E	E	E	E	C	C	U	G	E	E	E	

This chart is intended for reference use only. The information in this chart pertains strictly to material compatibility and is not intended to be used as an application guide. For information on specific applications not included in this catalog, please contact Danfoss Aeroquip.

*Viton is a trademark of The Chemours Company FC, LLC.
 †Hytrell is a registered trademark of E.I. du Pont.
 ‡Monel is a registered trademark of Special Metals Corporation group of Companies.
 Note 1 - Rubber-covered hose must be perforated to allow gas to escape.
 Note 2 - Due to the widely different additives in these fluids, testing should be done on the actual fluid being considered.

Fluid compatibility

Fluid	Hose						Seals						Metal																
	Synthetic rubber (Nitrile)		Thermoplastic elastomer		Special application hose		Buna-N		Neoprene		EPR		Viton*		Urethane		Hytrell†		Steel		Brass		Stainless steel		Aluminum		Monel‡		
	1	2	3	4	5	6	1	2	3	4	5	6	1	2	3	4	5	6	1	2	3	4	5	6	1	2	3	4	5
Ferric nitrate, 10% aq	E	E	C	E	-	E	E	E	E	E	E	E	C	C	U	U	U	U	U	U	U	U	U	U	U	U	U	U	
Ferric sulfate, 10% aq	E	E	C	E	-	E	G	G	G	E	C	C	U	U	E	E	U	U	U	U	U	U	U	U	U	U	U	U	
Formaldehyde	U	E	C	U	-	E	C	C	G	G	C	C	U	U	E	E	G	G	U	U	U	U	U	U	U	U	U	U	
Formic acid	G	E	U	C	-	E	C	G	E	U	U	U	U	C	C	C	C	U	U	U	U	U	U	U	U	U	U	U	
Fuel oil	E	E	G	E	-	U	E	G	U	E	G	G	E	E	E	E	E	E	E	E	E	E	E	E	E	E	E	E	
Furfural	U	E	-	U	-	G	C	C	G	U	U	-	G	G	G	G	U	U	U	U	U	U	U	U	U	U	U	U	
Gasoline ²	G	E	E	G	-	U	E	C	U	E	E	E	E	E	E	E	E	E	E	E	E	E	E	E	E	E	E	E	
Gasohol ²	G	E	G	C	-	U	G	G	U	E	E	E	E	E	E	E	E	E	E	E	E	E	E	E	E	E	E	E	
Glycerine/Glycerol	E	E	E	E	-	E	E	E	E	E	G	E	E	E	G	E	E	E	E	E	E	E	E	E	E	E	E	E	
Green sulfate liquor	G	E	-	U	-	E	G	G	E	E	-	-	U	U	E	U	U	U	U	U	U	U	U	U	U	U	U	U	
Heptane	E	E	E	C	-	U	E	G	U	E	G	G	E	E	E	E	E	E	E	E	E	E	E	E	E	E	E	E	
Hexaldehyde	U	E	-	U	-	E	U	G	G	U	U	-	G	G	E	E	G	U	U	U	U	U	U	U	U	U	U	U	
Hexane	E	E	E	E	-	U	E	G	U	E	G	G	E	E	E	E	E	E	E	E	E	E	E	E	E	E	E	E	
Hydraulic oils ²																													
Ester blend	C	E	C	G	-	C	E	U	U	E	U	E	E	E	E	E	E	E	E	E	E	E	E	E	E	E	E	E	
Phos. Ester/petroleum blend	U	E	C	U	-	U	U	U	C	U	G	E	E	E	E	E	E	E	E	E	E	E	E	E	E	E	E	E	
Silicone oils	E	E	E	E	-	E	E	E	E	E	E	E	E	E	E	E	E	E	E	E	E	E	E	E	E	E	E	E	
Straight petroleum base	E	E	E	E	-	U	E	G	U	E	E	E	E	E	E	E	E	E	E	E	E	E	E	E	E	E	E	E	
Straight phosphate ester	U	E	C	U	-	E	U	U	G	C	U	G	E	E	E	E	E	E	E	E	E	E	E	E	E	E	E	E	
Water glycol	E	E	C	G	-	E	E	E	E	E	C	C	E	E	E	G	E	E	E	E	E	E	E	E	E	E	E	E	
Water petroleum emulsion	E	E	C	G	-	U	E	G	U	E	C	C	E	E	G	E	E	E	E	E	E	E	E	E	E	E	E	E	
Hydrobromic acid	U	E	U	U	-	G	U	U	E	E	U	U	E	E	U	U	U	U	U	U	U	U	U	U	U	U	U	U	
Hydrochloric acid, cold	U	E	U	U	-	G	U	U	G	E	U	U	U	U	U	U	U	U	U	U	U	U	U	U	U	U	U	U	
Hydrocyanic acid	C	E	-	U	-	E	C	C	E	E	-	-	E	E	G	E	G	U	U	U	U	U	U	U	U	U	U	U	
Hydrofluoric acid	U	E	U	U	-	U	U	U	C	U	U	U	U	U	U	U	U	U	U	U	U	U	U	U	U	U	U	U	
Hydrofluorosilic acid	E	E	-	G	-	G	G	G	E	E	-	-	U	U	U	U	U	U	U	U	U	U	U	U	U	U	U	U	
Hydrogen ¹	G	C	G	G	-	E	E	E	E	E	E	E	E	E	E	E	E	E	E	E	E	E	E	E	E	E	E	E	
Hydrogen peroxide	C	E	G	C	-	G	G	G	E	G	G	U	U	U	U	U	U	U	U	U	U	U	U	U	U	U	U	U	
Hydrogen sulfide, dry	C	C	C	U	-	E	U	G	E	U	-	G	E	G	G	G	U	U	U	U	U	U	U	U	U	U	U	U	
Isocyanate	U	E	U	U	-	U	U	U	G	E	U	U	U	U	U	U	U	U	U	U	U	U	U	U	U	U	U	U	
Iso octane	G	E	E	G	-	U	E	G	U	E	G	E	E	E	E	E	E	E	E	E	E	E	E	E	E	E	E	E	
Isopropyl acetate	U	E	C	U	-	C	U	U	G	U	U	C	E	-	E	E	E	E	E	E	E	E	E	E	E	E	E	E	
Isopropyl alcohol	G	E	C	G	-	E	G	G	E	E	U	C	E	E	E	G	U	U	U	U	U	U	U	U	U	U	U	U	
Isopropyl ether	G	E	-	C	-	U	G	U	U	U	C	-	G	G	G	-	-	U	U	U	U	U	U	U	U	U	U	U	
Lime sulfur	U	E	C	U	-	E	U	E	E	E	C	C	G	U	G	-	U	U	U	U	U	U	U	U	U	U	U	U	
Linseed oil	E	E	G	G	-	U	E	G	U	E	G	G	E	E	E	E	E	E	E	E	E	E	E	E	E	E	E	E	
LPG ¹	LPG approved hose only						E	G	U	E	-	-	E	E	E	E	E	E	E	E	E	E	E	E	E	E	E	E	E
Lubricating oils ²	See hydraulic oils						See hydraulic oils						See hydraulic oils																
Magnesium hydroxide, 10% aq	G	E	C	G	-	E	G	G	E	E	C	C	E	E	E	G	E	E	E	E	E	E	E	E	E	E	E	E	
Magnesium sulfate, 10% aq	E	E	C	E	-	E	E	E	E	E	C	C	E	E	E	E	E	E	E	E	E	E	E	E	E	E	E	E	
Maleic acid	U	E	C	C	-	G	U	U	U	E	C	C	E	G	G	U	U	U	U	U	U	U	U	U	U	U	U	U	
Maleic anhydride	U	E	C	U	-	C	U	U	U	E	C	C	G	U	E	G	E	E	E	E	E	E	E	E	E	E	E	E	
Malic acid	G	E	-	G	-	U	G	G	U	G	-	-	U	-	E	G	E	E	E	E	E	E	E	E	E	E	E	E	
Mercuric chloride	G	E	E	G	-	G	E	E	E	E	E	E	U	U	U	U	U	U	U	U	U	U	U	U	U	U	U	U	
Mercury	E	E	E	E	-	E	E	E	E	E	E	E	E	E	E	E	E	E	E	E	E	E	E	E	E	E	E	E	
Methanol	E	E	C	E	-	E	G	G	E	U	C	C	G	G	E	C	E	E	E	E	E	E	E	E	E	E	E	E	

= Excellent – Fluid has little or no effect.
 = Good – Fluid has minor to moderate effect.
 = Conditional – Service conditions should be described to Danfoss Aeroquip for determination of suitability for application.
 = Unsatisfactory

Fluid compatibility

This chart is intended for reference use only. The information in this chart pertains strictly to material compatibility and is not intended to be used as an application guide. For information on specific applications not included in this catalog, please contact Danfoss Aeroquip.

*Viton is a trademark of The Chemours Company FC, LLC.
 †Hytrell is a registered trademark of E.I. du Pont.
 ‡Monel is a registered trademark of Special Metals Corporation group of Companies.
 Note 1 - Rubber-covered hose must be perforated to allow gas to escape.
 Note 2 - Due to the widely different additives in these fluids, testing should be done on the actual fluid being considered.

Fluid	Synthetic rubber (Nitrile)						Thermoplastic elastomer						Special application hose						Metal									
	Hose		Seals		Metal		Hose		Seals		Metal		Hose		Seals		Metal		Hose		Seals		Metal					
	1	2	3	4	5	6	Buna-N	Neoprene	EPR	Viton*	Urethane	Hytrell†	Steel	Brass	Stainless steel	Aluminum	Monel‡	Buna-N	Neoprene	EPR	Viton*	Urethane	Hytrell†	Steel	Brass	Stainless steel	Aluminum	Monel‡
Methyl bromide	C	E	U	U	-	U	G	U	U	E	U	U	E	E	G	U	E	E	E	U	U	U	E	E	G	U	E	
Methyl chloride	U	E	U	U	-	U	U	U	U	E	U	U	E	E	E	U	G	U	U	U	U	U	U	E	E	E	U	G
Methyl butyl ketone	U	E	U	U	-	E	U	U	U	E	U	C	C	E	E	-	E	U	U	U	U	U	U	E	E	E	-	E
Methyl ethyl ketone	U	E	U	U	-	E	U	U	U	E	U	U	G	G	G	G	G	U	U	U	U	U	U	G	G	G	G	G
Methylene chloride	U	E	U	U	-	U	U	U	U	G	U	U	G	G	G	G	G	U	U	U	U	U	U	G	G	G	G	G
Methyl isobutyl ketone	U	E	U	U	-	E	U	U	U	U	U	U	G	G	G	G	G	U	U	U	U	U	U	G	G	G	G	G
Methyl isopropyl ketone	U	E	U	C	-	E	U	U	U	U	U	U	G	G	G	G	G	U	U	U	U	U	U	G	G	G	G	G
Methyl salicylate	U	E	-	U	-	C	U	U	C	U	-	-	E	G	G	E	G	U	U	U	U	U	U	G	G	E	G	G
MIL-L-2104	E	E	E	E	-	U	E	G	U	E	E	E	E	E	E	-	E	U	U	U	U	U	U	E	E	E	-	E
MIL-H-5606	E	E	E	E	-	U	E	G	U	E	E	E	E	E	E	-	E	U	U	U	U	U	U	E	E	E	-	E
MIL-H-6083	E	E	E	E	-	U	E	E	U	E	E	E	E	E	E	-	E	U	U	U	U	U	U	E	E	E	-	E
MIL-L-7808	G	E	G	G	-	U	G	U	U	E	G	G	G	G	E	-	E	U	U	U	U	U	U	E	E	E	-	E
MIL-L-23699	E	E	-	G	-	U	G	U	U	E	-	-	E	E	E	-	E	U	U	U	U	U	U	E	E	E	-	E
MIL-H-46170	G	E	-	G	-	C	E	G	U	E	-	-	E	E	E	-	E	U	U	U	U	U	U	E	E	E	-	E
MIL-H-83282	G	E	-	G	-	U	E	U	U	E	-	-	E	E	E	-	E	U	U	U	U	U	U	E	E	E	-	E
Mineral oils	E	E	G	E	-	U	E	G	U	E	G	G	E	E	E	-	E	U	U	U	U	U	U	E	E	E	-	E
Naphthalene	U	E	U	U	-	U	U	U	U	E	C	G	E	G	E	G	G	U	U	U	U	U	U	E	E	E	-	E
Naphthenic acid	U	E	-	U	-	U	C	U	U	E	-	-	-	G	E	G	G	U	U	U	U	U	U	E	E	E	-	E
Natural gas ¹	LPG approved hose only						E	E	U	E	-	-	G	G	G	G	G	U	U	U	U	U	U	E	E	E	-	E
Nickel acetate, 10% aq	G	C	U	G	-	E	C	E	G	U	U	G	C	E	G	E	U	U	U	U	U	U	U	E	E	E	-	E
Nickel chloride, 10% aq	E	E	U	E	-	E	E	G	E	E	U	U	U	U	G	U	G	U	U	U	U	U	U	E	E	E	-	E
Nickel sulfate, 10% aq	E	E	U	E	-	E	E	E	E	U	U	U	G	G	U	G	U	U	U	U	U	U	U	E	E	E	-	E
Nitric acid, to 10%	U	E	U	U	-	G	U	U	U	E	U	C	U	U	E	U	U	U	U	U	U	U	U	E	E	E	-	E
Nitric acid, over 10%	U	C	U	U	-	U	U	U	U	G	U	U	U	U	E	C	U	U	U	U	U	U	U	E	C	U	U	E
Nitrobenzene	U	E	U	U	-	E	U	U	U	G	U	U	E	G	E	E	E	U	U	U	U	U	U	E	E	E	-	E

- = Excellent – Fluid has little or no effect.
- = Good – Fluid has minor to moderate effect.
- = Conditional – Service conditions should be described to Danfoss Aeroquip for determination of suitability for application.
- = Unsatisfactory

Fluid	Synthetic rubber (Nitrile)						Thermoplastic elastomer						Special application hose						Metal									
	Hose		Seals		Metal		Hose		Seals		Metal		Hose		Seals		Metal		Hose		Seals		Metal					
	1	2	3	4	5	6	Buna-N	Neoprene	EPR	Viton*	Urethane	Hytrell†	Steel	Brass	Stainless steel	Aluminum	Monel‡	Buna-N	Neoprene	EPR	Viton*	Urethane	Hytrell†	Steel	Brass	Stainless steel	Aluminum	Monel‡
Nitrogen ¹	E	E	E	E	-	E	E	E	E	E	E	E	E	E	E	-	E	E	E	E	E	E	E	E	E	E	-	E
Octyl alcohol	C	E	E	U	-	U	E	E	E	E	E	E	E	E	E	-	E	E	E	E	E	E	E	E	E	E	-	E
Oleic acid	G	E	G	U	-	U	U	U	C	G	G	E	C	E	G	C	G	U	U	U	C	G	E	C	E	G	C	G
Ortho-dichlorobenzene	U	E	-	U	-	U	U	U	U	E	-	-	G	G	G	G	G	U	U	U	U	U	U	E	E	E	-	E
Oxalic acid, 10% aq	C	E	C	C	-	E	G	G	E	E	C	C	U	C	C	C	C	U	U	U	U	U	U	C	C	C	C	
Oxygen ¹	U	U	U	U	-	E	-	-	-	-	-	-	G	G	G	G	G	U	U	U	U	U	U	E	E	E	-	E
Para-dichlorobenzene	U	E	-	U	-	U	U	U	U	E	-	-	G	G	G	G	G	U	U	U	U	U	U	E	E	E	-	E
Pentane ¹	Lpg approved hose only						E	E	U	E	U	G	G	G	E	G	E	U	U	U	U	U	U	U	U	U	U	U
Perchloric acid	U	E	U	U	-	G	E	G	G	E	U	U	U	U	U	U	U	U	U	U	U	U	U	C	G	G	E	E
Per-chloroethylene	U	E	U	U	-	U	U	U	U	E	U	U	C	G	G	E	E	U	U	U	U	U	U	C	G	G	E	E
Petroleum base oils	G	E	E	E	-	U	E	G	U	E	E	E	E	E	E	-	E	U	U	U	U	U	U	E	E	E	-	E
Phenol (carbolic acid)	U	E	U	U	-	U	U	U	G	E	U	U	U	E	E	E	E	U	U	U	U	U	U	E	E	E	-	E
Phosphate ester ²	U	E	C	U	-	E	U	U	G	C	U	G	E	E	E	E	E	U	U	U	U	U	U	E	E	E	-	E
Phosphoric acid 20%	U	E	U	U	-	E	U	U	G	E	U	U	U	U	U	U	U	U	U	U	U	U	U	E	E	E	-	E
Phosphorous trichloride	U	E	U	U	-	E	U	U	E	E	U	U	C	U	C	E	E	U	U	U	U	U	U	C	U	C	E	E
Potassium Acetate, 10% aq	G	E	-	G	-	E	G	G	E	U	-	-	C	G	C	U	G	U	U	U	U	U	E	E	E	-	E	
Potassium chloride, 10% aq	E	E	E	E	-	E	E	E	E	E	E	E	E	C	E	U	G	U	U	U	U	U	E	E	E	-	E	
Potassium cyanide, 10% aq	E	E	E	G	-	E	E	E	E	E	E	E	C	U	G	U	C	U	U	U	U	U	E	E	E	-	E	
Potassium dichromate, 10% aq	E	E	E	E	-	E	E	E	E	E	E	E	C	C	C	C	C	U	U	U	U	U	E	E	E	-	E	
Potassium hydroxide, to 10%	G	E	C	C	-	E	G	G	E	G	C	C	G	G	G	U	E	U	U	U	U	U	E	E	E	-	E	
Potassium hydroxide, over 10%	C	E	U	C	-	E	C	C	E	U	U	U	G	G	G	U	E	U	U	U	U	U	E	E	E	-	E	
Potassium nitrate, 10% aq	E	E	E	E	-	E	E	E	E	E	E	E	G	E	G	-	E	U	U	U	U	U	E	E	E	-	E	
Potassium sulfate, 10% aq	E	E	E	E	-	E	E	E	E	E	E	E	-	-	-	-	E	U	U	U	U	U	E	E	E	-	E	
Propane ¹ (liquefied)	LPG approved hose only						C	-	-	-	-	-	E	E	E	E	E	U	U	U	U	U	E	E	E	-	E	

This chart is intended for reference use only.
 The information in this chart pertains strictly to material compatibility and is not intended to be used as an application guide. For information on specific applications not included in this catalog, please contact Danfoss Aeroquip.

*Viton is a trademark of The Chemours Company FC, LLC.
 †Hytrell is a registered trademark of E.I. du Pont.
 ‡Monel is a registered trademark of Special Metals Corporation group of Companies.
 Note 1 - Rubber-covered hose must be perforated to allow gas to escape.
 Note 2 - Due to the widely different additives in these fluids, testing should be done on the actual fluid being considered.

Fluid compatibility

Fluid	Hose						Seals						Metal																
	Synthetic rubber (Nitrile)		PTFE		Thermoplastic elastomer		Buna-N		Neoprene		EPR		Viton*		Urethane		Hytrell†		Steel		Brass		Stainless steel		Aluminum		Monel‡		
	1	2	3	4	5	6	1	2	3	4	5	6	1	2	3	4	5	6	1	2	3	4	5	6	1	2	3	4	5
Propyl acetate	U	E	-	U	-	G	U	U	G	U	-	-	E	-	E	E	E	E	E	E	E	E	E	E	E	E	E	E	E
Propyl alcohol	E	E	U	E	-	E	E	E	E	E	U	U	E	E	E	E	E	E	E	E	E	E	E	E	E	E	E	E	E
Propylene ¹	U	E	-	U	-	U	U	U	U	E	-	-	E	E	E	E	E	E	E	E	E	E	E	E	E	E	E	E	E
	E	-	G	C	-	C	G	E	C	E	E	E	E	E	E	E	E	E	E	E	E	E	E	E	E	E	E	E	E
Refrigerant R-131	E	-	G	C	-	G	G	E	C	E	E	E	E	E	E	E	E	E	E	E	E	E	E	E	E	E	E	E	E
Refrigerant R-221	U	C	U	U	-	E	U	E	C	U	U	U	E	E	E	E	E	E	E	E	E	E	E	E	E	E	E	E	E
Refrigerant R-134a ¹	C	C	U	U	-	E	E	C	U	U	U	E	E	E	E	E	E	E	E	E	E	E	E	E	E	E	E	E	E
	G	E	E	G	-	E	E	E	E	E	U	E	G	G	G	G	G	G	G	G	G	G	G	G	G	G	G	G	G
Silicone oils	G	E	E	G	-	E	E	E	E	E	E	E	E	E	E	E	E	E	E	E	E	E	E	E	E	E	E	E	E
Soap (water solutions)	E	E	C	E	-	E	E	E	E	E	C	C	E	E	E	U	E	E	E	E	E	E	E	U	E	E	E	E	E
Sodium acetate, 10% aq	G	U	-	G	-	E	G	G	E	U	-	-	E	E	E	G	E	E	E	E	E	E	E	E	E	E	E	E	E
Sodium Bicarbonate, 10% aq	E	E	E	E	-	E	E	E	E	E	E	E	E	E	E	E	E	G	G	E	G	E	G	E	E	E	E	E	E
Sodium borate, 10% aq	E	E	E	E	-	E	E	E	E	E	E	E	E	E	E	E	E	E	E	E	E	E	E	G	-	E	E	E	E
Sodium carbonate, 10% aq	E	E	E	E	-	E	E	E	E	E	E	E	E	E	E	E	E	G	E	U	E	E	E	E	E	E	E	E	E
Sodium chloride, 10% aq	E	E	E	G	-	E	E	E	E	E	E	E	U	C	C	C	E	E	E	E	E	E	E	E	E	E	E	E	E
Sodium cyanide, 10% aq	E	E	E	E	-	E	E	E	E	E	E	E	E	-	C	U	U	E	E	E	E	E	E	E	E	E	E	E	E
Sodium hydroxide, to 10%	C	E	G	C	-	E	U	G	E	E	G	G	C	C	C	U	C	C	C	C	C	C	C	U	C	E	E	E	E
Sodium hydroxide, over 10%	U	E	C	U	-	E	U	U	G	E	C	C	C	C	C	U	U	U	U	U	U	U	U	U	U	C	E	E	E
Sodium hypochlorite, 10% aq	C	E	C	G	-	G	C	C	E	C	C	C	U	U	U	U	C	U	U	U	U	U	U	U	C	E	E	E	E
Sodium metaphosphate, 10% aq	E	E	E	E	-	E	E	E	E	E	E	E	E	E	E	E	E	G	G	U	G	E	G	U	G	E	E	E	E
Sodium nitrate, 10% aq	G	E	E	G	-	E	G	G	E	-	-	E	E	E	E	E	G	G	E	-	E	E	E	E	E	E	E	E	E
Sodium perborate, 10% aq	G	E	-	G	-	E	G	G	E	E	-	-	E	E	E	E	E	E	E	E	E	E	E	C	U	C	U	C	C
Sodium peroxide, 10% aq	G	E	-	G	-	G	G	G	E	E	U	-	U	U	C	C	C	U	U	C	C	C	C	C	C	C	C	C	C
Sodium phosphates, 10% aq	E	E	E	C	-	E	E	E	E	E	E	E	E	E	E	E	E	U	E	G	U	E	E	E	E	E	E	E	E
Sodium silicate, 10% aq	E	E	E	G	-	E	E	E	E	E	E	E	E	E	E	E	E	E	E	E	E	E	E	E	E	E	E	E	E
Sodium sulfate, 10% aq	E	E	E	G	-	E	E	E	E	E	E	E	E	E	E	E	E	C	G	G	G	G	G	G	G	G	G	G	G
Sodium sulfide, 10% aq	E	E	E	G	-	E	E	E	E	E	E	E	E	E	E	E	E	C	U	C	U	G	E	E	E	E	E	E	E
Sodium thiosulfate, 10% aq	G	E	E	G	-	E	G	E	E	E	E	E	E	E	U	U	C	G	E	E	E	E	E	E	E	E	E	E	E
Soy bean oil	E	E	G	C	-	U	E	G	U	E	G	G	E	E	E	E	E	E	E	E	E	E	E	E	E	E	E	E	E
Stannic chloride	G	E	C	G	-	E	E	G	E	E	C	C	U	U	U	U	U	U	U	U	U	U	U	U	U	U	U	U	U
Steam ¹ (up to 388°F)	U	E	U	U	-	G	U	U	C	C	U	U	E	E	E	E	E	E	E	E	E	E	E	E	E	E	E	E	E
Stearic acid	G	E	G	G	-	G	G	G	G	E	G	G	C	C	E	C	E	E	E	E	E	E	E	E	E	E	E	E	E
Stoddard solvent	G	E	U	C	-	U	E	G	U	E	U	U	E	E	E	E	E	E	E	E	E	E	E	E	E	E	E	E	E
Styrene	U	E	U	U	-	U	U	U	U	G	U	U	E	E	E	E	E	E	E	E	E	E	E	E	E	E	E	E	E
Sulfur, slurry	C	E	G	E	-	E	U	E	E	E	G	G	E	U	G	E	E	E	E	E	E	E	E	E	E	E	E	E	E
Sulfur chloride, wet	U	E	-	U	-	U	U	U	U	E	-	-	G	-	G	G	U	E	E	E	E	E	E	E	E	E	E	E	E
Sulfur dioxide, dry ¹	U	E	U	U	-	E	U	G	E	U	U	E	G	G	E	G	E	G	G	E	G	E	G	E	G	E	G	E	G
Sulfuric acid, to 10%	U	E	U	U	-	E	U	G	U	E	C	C	U	G	C	-	E	U	G	C	-	E	E	E	E	E	E	E	E
Sulfuric acid, over 10%	U	E	U	U	-	U	U	U	G	U	U	C	U	U	C	U	C	U	C	C	U	C	U	C	U	C	U	C	U
Sulfurous acid	U	E	U	G	-	G	C	C	U	G	U	U	U	U	C	C	U	U	U	U	U	U	U	U	C	C	C	U	U
	G	E	G	G	-	E	G	E	E	E	G	G	E	E	E	E	E	G	G	E	E	E	E	E	E	E	E	E	E
Tar (Bituminous)	G	E	G	G	-	U	G	U	U	E	G	G	E	E	E	E	E	E	E	E	E	E	E	E	E	E	E	E	E
Tartaric acid	E	E	G	E	-	G	E	G	G	E	G	G	U	C	C	E	E	E	E	E	E	E	E	E	E	E	E	E	E
Tertiary butyl alcohol	G	E	G	E	-	G	G	G	G	E	G	G	G	G	G	G	G	G	G	G	G	G	G	G	G	G	G	G	G
Titanium tetrachloride	U	E	-	U	-	U	C	U	U	E	-	-	E	U	G	U	E	E	E	E	E	E	E	E	E	E	E	E	E
Toluene (toluol)	U	E	U	U	-	U	U	U	U	E	U	U	E	U	E	E	E	E	E	E	E	E	E	E	E	E	E	E	E

- = Excellent – Fluid has little or no effect.
- = Good – Fluid has minor to moderate effect.
- = Conditional – Service conditions should be described to Danfoss Aeroquip for determination of suitability for application.
- = Unsatisfactory

Fluid compatibility

Fluid	Hose						Seals						Metal				
	1	2	3	4	5	6	Buna-N	Neoprene	EPR	Viton*	Urethane	Hytre!†	Steel	Brass	Stainless steel	Aluminum	Monel‡
Trichlorethylene	U	E	U	U	-	U	U	U	U	E	U	U	E	G	E	E	E
Tricresyl Phosphate	U	E	U	U	-	E	U	U	E	G	U	U	E	-	C	-	G
Triethanolamine	G	E	U	G	-	E	E	U	E	U	U	U	E	U	E	E	E
Tung Oil	E	E	C	C	-	U	G	G	U	E	U	C	E	G	E	E	E
Turpentine	E	E	G	G	-	U	G	U	U	E	G	G	G	G	G	G	G
Varnish	C	E	G	G	-	U	G	U	U	E	G	G	E	G	E	E	E
Vinyl Chloride	U	E	U	U	-	U	U	U	U	E	U	U	E	U	C	E	E
Water (to +150°F)	E	E	E	G	-	E	E	E	E	E	E	E	C	G	E	G	E
Water (+151°F to +200°F)	C	E	U	C	-	E	E	E	E	U	U	C	G	E	G	E	E
Water (+201°F to +350°F)	U	E	U	U	-	E	U	U	G	G	U	U	C	G	E	G	E
Water Glycol	E	E	C	E	-	E	E	E	E	E	C	C	E	E	E	G	E
Water Petroleum Emulsion ²	E	E	C	C	-	U	E	G	U	E	C	C	C	E	E	G	E
Xylene	U	E	C	U	-	U	U	U	U	E	U	C	E	E	E	E	E
Zinc Chloride, 10% aq	E	E	E	E	-	E	E	E	E	E	E	E	E	U	U	C	G
Zinc Sulfate, 10% aq	E	E	-	E	-	E	E	E	E	E	-	-	U	C	G	C	G

- = Excellent – Fluid has little or no effect.
- = Good – Fluid has minor to moderate effect.
- = Conditional – Service conditions should be described to Danfoss Aeroquip for determination of suitability for application.
- = Unsatisfactory

This chart is intended for reference use only. The information in this chart pertains strictly to material compatibility and is not intended to be used as an application guide. For information on specific applications not included in this catalog, please contact Danfoss Aeroquip.

*Viton is a trademark of The Chemours Company FC, LLC.

†Hytre! is a registered trademark of E.I. du Pont.

‡Monel is a registered trademark of Special Metals Corporation group of Companies.

Note 1 - Rubber-covered hose must be perforated to allow gas to escape.

Note 2 - Due to the widely different additives in these fluids, testing should be done on the actual fluid being considered.

Hydraulic fluids & lubricating oils

The following charts are a representative list of fluids and manufacturers. The fluids are grouped under generic “family” heads and arranged alphabetically. For each generic “family” listing we have included maximum fluid temperature recommendations for the six hose classifications on page 344 (1 through 6). Two maximum fluid temperature ratings are listed under designations of “H” and “LP”. The “H” designation is for hydraulic service up to the maximum rated operating pressure of any particular hose in the classification. The “LP” designation is for low-pressure service such as lubricating oil systems or low-pressure hydraulic return lines. The letter “U” in the box indicates unsatisfactory resistance to the fluid type. Fluid temperature ratings are predicated on maximum allowable ambient temperatures as follows:

Classifications 1 and 3

(Synthetic rubber and thermoplastic elastomer)

“H” fluid temp. ratings: +140°F ambient

“LP” fluid temp. ratings: +180°F ambient

Classification 2 (PTFE)

“H” fluid temp. ratings: +400°F ambient

“LP” fluid temp. ratings: +400°F ambient

Classification 4 (AQP)

“H” fluid temp. ratings: +160°F ambient

“LP” fluid temp. ratings: +250°F ambient

(If “H” fluid temperature is +225°F or less, allowable ambient temperature may be increased to +200°F)

Caution: The fluid manufacturer’s recommended maximum operating temperature for any specific name brand fluid should be scrupulously observed by the user. These recommended temperatures can vary widely between name brands of different fluid compositions, even though they fall into the same generic “family” of fluids. Exceeding the manufacturer’s recommended maximum temperature can result in fluid breakdown, producing by-products that are harmful to elastomeric products, as well as other materials in the system. If a manufacturer’s recommended maximum temperature for his specific fluid is lower than that for the hose rating, it should take precedence over the hose rating for service usage.

Fluid compatibility

Hydraulic fluids & lubricating oils (continued)

Water and petroleum oil emulsion (fr)

Maximum fluid temperature recommendation.

See caution on page 350 for maximum fluid temperatures and limiting ambient temperatures.

Hose classifications (see page 350)				
	1	2	3	4
H	+200°F	+250°F	+150°F	+200°F
LP	+200°F	+250°F	+150°F	+200°F

Aqualube	Masol fire resistant fluid
Astrol #587	Meltran FR 900
	Mine guard
Chevron FR Fluid D	Mobilmet S122
Chrysler L-705	
Citgo pacemaker invert FR fluid	Penn drake hydraqua fluid
Conoco FR hydraulic fluid	Permamul FR
	Puro FR fluid
	Pyrogard C
Dasco IFR	Pyrogard D
Duro FR-HD	
	Quintolubric 957 series
Fire resistant hydrafluid	Quintolubric 958 series
Fire resistant hydraulic Fluid B	
FR 3110 hydraulic fluid (invert)	Regent hydrolube #670
Fyre-safe W/O	
	Safoil hydraulic fluid anti-wear
Gulf R & D FR fluid	Sinclair Duro FR-HD
	Solvac 1535G
Houghto-safe 5046	Staysol FR
Houghto-safe 5046W	Sunsafe F
Hulsafe 500	
Hy-chock oil	Union FR fluid
Hydrasol A	Union soluble oil HD
Ironsides #814-A	Veedol auburn FRH
Irus fluid 905	Veedol auburn FRH Concentrate
Kutwell 40	

Water and glycol solution

Maximum fluid temperature recommendation.

See caution on page 350 for maximum fluid temperatures and limiting ambient temperatures.

Hose classifications (see page 350)				
	1	2	3	4
H	+200°F	+250°F	+150°F	C
LP	+200°F	+250°F	+150°F	C

Chem-trend HF-18	Maxmul
Chem-trend HF-20	Maxmul FR
Chevron glycol FR fluids	Melsyn 200
Citgo glycol FR fluids	Melsyn glycol FR
Citgo glycol FR-20 XD	
Citgo pacemaker	Nyvac FR fluid
	Nyvac FR 200 fluid
	Nyvac 20 (WG)
Dasco FR 150	Nyvac 30 (WG)
Dasco FR 200	
Dasco FR 200 B	
Dasco FR 310	Park water glycol hydraulic fluid
	Pennzoil fluid FR 2X
Fyrguard 150	
Fyrguard 200	
Fyre-Safe 225	Quintolubric 700 series
Gulf FR fluid G-200	Santosafe W/G 15
Gulf FR fluid – G series	Santosafe W/G 20
	Santosafe W/G 30
Houghto-safe 271	Standard glycol FR #15
Houghto-safe 416	Standard glycol FR #20
Houghto-safe 520	Standard glycol FR #25
Houghto-safe 525	
Houghto-safe 616	Ucon hydrolube 150 CP
Houghto-safe 620	Ucon hydrolube 200 CP
Houghto-Safe 625	Ucon hydrolube 275 CP
Houghto-safe 640	Ucon hydrolube 300 CP
Hydra safe 620	Ucon hydrolube 550 CP
Hydra safe 625	Ucon hydrolube 900 CP
Hydraulic safety fluid 200	Ucon hydrolube 150 DB
Hydraulic safety fluid 300	Ucon hydrolube 275 DB
Hyspin AF-1	Ucon hydrolube 150 LT
Hyspin AF-2	Ucon hydrolube 200 LT
Hyspin AF-3	Ucon hydrolube 275 LT
	Ucon hydrolube 300 LT
	Ucon M-1
	Ucon hydrolube 200 NM
	Ucon hydrolube 300 NM

Hydraulic fluids & lubricating oils (continued)

Straight phosphate-ester (fr)

Maximum fluid temperature recommendation.

See caution on page 350 for maximum fluid temperatures and limiting ambient temperatures.

Hose classifications (see page 350)					
	1	2	3	4	6
H	U	+400°F	+200°F	U	200
LP	U	+400°F	+200°F	U	200

FR Fluids	Houghto-Safe 1010
Fyrquel 90	Houghto-Safe 1055
Fyrquel 150	Houghto-Safe 1115
Fyrquel 220	Houghto-Safe 1120
Fyrquel 300	Houghto-Safe 1130
Fyrquel 550	
Fyrquel 1000	Pyrogard 51
Fyrquel 150 R & O	Pyrogard 53
Fyrquel 220 R & O	Pyrogard 55
Fyrquel 550 R & O	

	Safetytex 215
Gulf FR Fluid P-37	Skydraul 500A
Gulf FR Fluid P-40	Skydraul 7000
Gulf FR Fluid P-43	
Gulf FR Fluid P-45	Univis P12
Gulf FR Fluid P-47	

Silicone oils

Maximum fluid temperature recommendation.

See caution on page 350 for maximum fluid temperatures and limiting ambient temperatures.

Hose classifications (see page 350)				
	1	2	3	4
H	+200°F	+400°F	+200°F	+300°F
LP	+250°F	+400°F	+200°F	+300°F

Dow Corning 200 Fluid (100CS)	Dow Corning 3-3672
Dow Corning QF1-2023	
Dow Corning 4-3600	

Ester blend turbine oils

Maximum fluid temperature recommendation.

See caution on page 350 for maximum fluid temperatures and limiting ambient temperatures.

Hose classifications (see page 350)				
	1	2	3	4
H	-	-	-	-
LP	+250°F	+450°F	+200°F	+300°F

Stauffer Jet I
Stauffer Jet II

Polyol-ester

Maximum fluid temperature recommendation.

See caution on page 350 for maximum fluid temperatures and limiting ambient temperatures.

Hose classifications (see page 350)				
	1	2	3	4
H	+150°F	+400°F	-	+150°F
LP	+200°F	+400°F	-	+250°F

Quintolubric 822 Series

Hose style			
Lubricant	GH001	FC800	FC802
Mineral oil	Y	*	Y
PAG	Y	Y	Y
Ester oil	Y	Y	Y
Alkylbenzene	*	*	Y

Y = Compatible N = Non-compatible.

* Contact product support for application review.

Hose selection

Hose routing and installation

In straight hose installations, allow enough slack in the hose line to provide for changes in length that will occur when pressure is applied. This change in length can be from +2% to -4%.

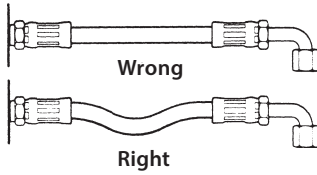

Keep the bend radius of the hose as large as possible to avoid collapsing of the hose and restriction of flow. Follow catalog specs on minimum bend radii.

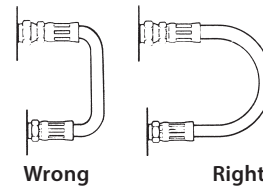

Do not twist hose during installation. This can be determined by the printed layline on the hose. Pressure applied to a twisted hose can cause hose failure or loosening of connections.

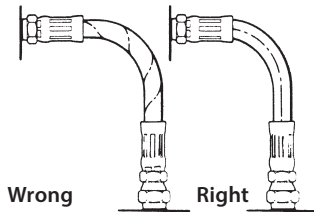

Minimum bend radius is measured on the inside bend of the hose. To determine minimum bend, divide the total distance between ends (B length) by 2. For example, B=6, minimum bend radius=3.

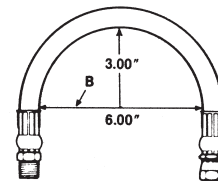

Keep hose away from hot parts. High ambient temperature will shorten hose life. If you can not route it away from the heat source, insulate it. (See Spring Guards page 250)

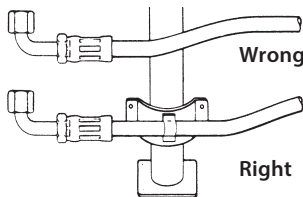

Install hose runs to avoid rubbing or abrasion. Use Aeroquip Hose Clamps to support long runs of hose or to keep hose away from moving parts. It is important that the clamps not allow the hose to move. This movement will cause abrasion and premature hose failure. (See Hose Clamps page 253)

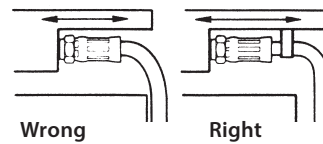

Use elbows and adapters in the installation to relieve strain on the assembly and to provide easier and neater installations that are accessible for inspection and maintenance.

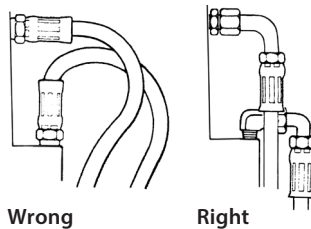

Make sure relative motion of the machine components produces bending rather than twisting of the hose. Hose should be routed so that the flex is in the same plane as the equipment movement.

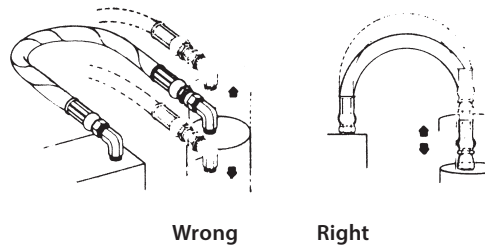

Refer to safety information regarding hose installation on page 336.

Analyzing failures

Everyone in maintenance encounters hose failures. Normally, there is no problem. The hose is replaced and the equipment goes back in operation. Occasionally the failures come too frequently – the same equipment with the same problems keep popping up. At this point the task is to determine and correct the cause of these repeated failures.

Beginning with the most obvious, the most common cause of hose failures – Improper application – compare the hose specifications with the requirements of the application.

Pay particular attention to the following areas:

- The maximum operating pressure of the hose.

- The recommended temperature range of the hose.

- Whether the hose is rated for vacuum service.

- The fluid compatibility of the hose.

Check all of these areas against the requirements of the application. If they don't match up, you need to select another hose. It's a good idea at this point to call on your local hose distributor for assistance in selecting the proper hose. Danfoss' distributors, for example, are well equipped to perform this service for you.

Distributor personnel attend special training courses in hydraulics and hose application conducted by the company. Or, if your problem is particularly difficult, the distributor can call on the services of Danfoss' field engineering staff. The company will send in a hose and hydraulic specialist to study the problem and come up with a solution.

The second major cause of premature hose failure is improper assembly and installation procedures. This can involve anything from using the wrong fitting on a hose, to poor routing of the hose.

Danfoss provides excellent training material that you can use to combat this problem. A little time spent in training your maintenance people could pay big dividends in reduced downtime.

Contact Danfoss to register for a training session today.

External damage can range from abrasion and corrosion, to hose that is crushed by a lift truck.

These are problems that can normally be solved simply once the cause is identified. The hose can be re-routed or clamped, or a fire sleeve or abrasion guard can be used.

In the case of corrosion, the answer may be as simple as changing to a hose with a more corrosion resistant cover or re-routing the hose to avoid the corrosive element.

Too frequent or premature hose failure can be the symptom of a malfunction in your equipment. This is a factor that should be considered since prompt corrective action can sometimes avoid serious and costly equipment breakdown. Reprints of an article on "Troubleshooting hydraulic systems," which tells you how to spot problems in a hydraulic system are available from Danfoss.

Occasionally a failure problem will lie in the hose itself. The most likely cause of a faulty rubber hose is old age. Check the lay line on the hose to determine the date of manufacture. (2Q99 means second quarter 1999.) The hose may have exceeded its recommended shelf life. If you suspect that the problem lies in the manufacture of the hose (and don't jump to this conclusion until you have exhausted the other possibilities) contact your distributor. Given effective quality control methods, the odds of a faulty batch of hose being released for sale are extremely small. So make sure that you haven't overlooked some other problem area.

Analyzing failures

A physical examination of the failed hose can often offer a clue to the cause of the failure. Following are 22 symptoms to look for along with the conditions that could cause them:

The hose tube is very hard and has cracked.



Heat has a tendency to leach the plasticizers out of the tube. This is a material that gives the hose its flexibility or plasticity.

Aerated oil causes oxidation to occur in the tube. This reaction of oxygen on a rubber product will cause it to harden. Any combination of oxygen and heat will greatly accelerate the hardening of the hose tube. Cavitation occurring inside the tube would have the same effect.

The hose is cracked both externally and internally but the elastomeric materials are soft and flexible at room temperature.

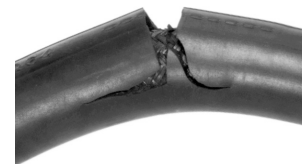

The probable reason is intense cold ambient conditions while the hose was flexed. Most standard hoses are rated to -40°F (-40°C). Some hoses are rated at -55°F (-49°C). Military specified hoses are generally rated to -65°F (-54°C). PTFE hose is rated to -100°F (-73°C). Some Everflex Polyon thermoplastic hoses are rated at -65°F (-54°C).

The hose has burst and examination of the wire reinforcement after stripping back the cover reveals random broken wires the entire length of the hose.



This would indicate a high frequency pressure impulse condition. SAE impulse test requirements for a double wire braid reinforcement are 200,000 cycles at 133% of recommended working pressure. The SAE impulse test requirements for a four spiral wrapped reinforcement (100R12) are 500,000 cycles at 133% maximum operating and at $+250^{\circ}\text{F}$ (121°C). If the extrapolated impulses in a system amount to over a million in a relatively short time a spiral reinforced hose would be the better choice.

Analyzing failures

Analyzing failures

The hose has burst, but there is no indication of multiple broken wires the entire length of the hose. The hose may have burst in more than one place.



This would indicate that the pressure has exceeded the minimum burst strength of the hose. Either a stronger hose is needed or the hydraulic circuit has a malfunction which is causing unusually high pressure conditions.

Hose has burst. An examination indicates the wire braid is rusted and the cover has been cut, abraded or deteriorated badly.



The primary function of the cover is to protect the reinforcement. Elements that may destroy or remove the hose covers are:

1. Abrasion
2. Cutting
3. Battery acid
4. Steam cleaners
5. Chemical cleaning solutions
6. Muriatic acid (for cement clean-up)
7. Salt water
8. Heat
9. Extreme cold

Once the cover protection is gone the wire reinforcement is susceptible to attack from moisture or other corrosive matter.

Hose has burst on the outside bend and appears to be elliptical in the bent section. In the case of a pump supply line, the pump is noisy and very hot. The exhaust line on the pump is hard and brittle.

Violation of the minimum bend radius is most likely the problem in both cases. Check the minimum bend radius and make sure that the application is within specifications. In the case of the pump supply line partial collapse of the hose is causing the pump to cavitate creating both noise and heat. This is a most serious situation and will result in catastrophic pump failure if not corrected.

Hose appears to be flattened out in one or two areas and appears to be kinked. It has burst in this area and also appears to be twisted.



Torquing of a hydraulic control hose will tear loose the reinforcement layers and allow the hose to burst through the enlarged gaps between the braided plaits of wire strands. Use swivel fittings or joints to be sure there is no twisting force on a hydraulic hose.

Hose type has broken loose from the reinforcement and piled up the end of the hose. In some cases it may protrude from the end of the hose fitting.

The probable cause is high vacuum or the wrong hose for vacuum service. No vacuum is recommended for double wire braid, 4 and 6 spiral wire hose unless some sort of internal coil support is used. Even though a hose is rated for vacuum service, if it is kinked, flattened out or bent too sharply this type of failure may occur.

Hose has burst about six to eight inches away from the end fitting. The wire braid is rusted. There are no cuts or abrasions of the outer cover.

Improper assembly of the hose end fitting allowing moisture to enter around the edge of the fitting socket. The moisture will wick through the reinforcement. The heat generated by the system will drive it out around the fitting area but six to eight inches away it will be entrapped between the inner line and outer cover causing corrosion of the wire reinforcement.

There are blisters in the cover of the hose. If one pricks the blisters, oil will be found in them.

A minute pin hole in the hose tube is allowing the high pressure oil to seep between it and the cover. Eventually it will form a blister wherever the cover adhesion is weakest. In the case of a screw together field attachable fitting insufficient lubrication of the hose and fitting can cause this condition because the dry tube will adhere to the rotating nipple and tear enough to allow seepage. Faulty hose can also cause this condition.

Blistering of the hose cover where a gaseous fluid is being used.



The high pressure gas is effusing through the hose tube, gathering under the cover and eventually forming a blister wherever the adhesion is weakest. Specially constructed hoses are available for high pressure gaseous applications. Your supplier can advise you on the proper hose to use in these cases.

Fitting blew off of the end of the hose.

It may be that the wrong fitting has been put on the hose. Recheck manufacturer's specifications and part numbers. In the case of a crimped fitting the wrong machine setting may have been used resulting in over or under crimping. The socket of a screw together fitting for multiple wire braided hose may be worn beyond its tolerance. The swaging dies in a swaged hose assembly may be worn beyond the manufacturer's tolerances. The fitting may have been applied improperly to the hose. Check manufacturer's instructions. The hose may have been installed without leaving enough slack to compensate for the possible 4% shortening that may occur when the hose is pressurized. This will impose a great force on the fitting. The hose itself may be out of tolerance.

The tube of the hose is badly deteriorated with evidences of extreme swelling. In some cases the hose tube may be partially "washed out."



Indications are that the hose tube is not compatible with the agent being carried. Even though the agent is normally compatible, the addition of heat can be the catalyst that can cause inner liner deterioration. Consult your hose supplier for a compatibility list or present him with a sample of the fluid being conducted by the hose for analysis. Make sure that the operating temperatures both internal and external do not exceed recommendations.

Hose has burst. The hose cover is badly deteriorated and the surface of the rubber is crazed.

Analyzing failures

Analyzing failures

This could be simply old age. The crazed appearance is the effect of weathering and ozone over a period of time. Try to determine the age of the hose. Some manufacturers print or emboss the cure date on the outside of the hose. As an example, Aeroquip hose would show "4Q01" which would mean that the hose was manufactured during the fourth quarter (October, November or December) of 2001.

Hose is leaking at the fitting because of a crack in the metal tube adjacent to the braze on a split flange head.

Because the crack is adjacent to the braze and not in the braze this is a stress failure brought on by a hose that is trying to shorten under pressure and has insufficient slack in it to do so. We have cured dozens of these problems by lengthening the hose assembly or changing the routing to relieve the forces on the fitting.

A spiral reinforced hose has burst and literally split open with the wire exploded out and badly entangled.



The hose is too short to accommodate the change in length occurring while it is pressured.

Hose is badly flattened out in the burst area. The tube is very hard down stream of the burst but appears normal up stream of the burst.



The hose has been kinked either by bending it too sharply or by squashing it in some way so that a major restriction was created. As the velocity of the fluid increases through the restriction the pressure decreases to the vaporization point of the fluid being conveyed. This is commonly called cavitation, and causes heat and rapid oxidation to take place which hardens the tube of the hose down stream of the restriction.

Hose has not burst but it is leaking profusely. A bisection of the hose reveals that the tube has been gouged through to the wire braid for a distance of approximately two inches.

This failure would indicate that erosion of the hose tube has taken place. A high velocity needle like fluid stream being emitted from an orifice and impinging at a single point on the hose tube will hydraulically remove a section of it. Be sure that the hose is not bent close to a port that is orificed. In some cases where high velocities are encountered particles in the fluid can cause considerable erosion in bent sections of the hose assembly.

The hose fitting has been pulled out of the hose. The hose has been considerably stretched out in length. This may not be a high pressure application.

Insufficient support of the hose. It is very necessary to support very long lengths of hose, especially if they are vertical. The weight of the hose along with the weight of the fluid inside the hose in these cases is being imposed on the hose fitting. This force can be transmitted to a wire rope or chain by clamping the hose to it much like the utilities support bundles of wire from pole to pole. Be sure to leave sufficient slack in the hose between clamps to make up for the possible 4% shortening that could take place when the hose is pressurized.

The hose has not burst but it is leaking profusely. An examination of the bisected hose reveals that the tube has burst inwardly.

This type of failure is commonly referred to as hose tube blow down. It is usually associated with very low viscosity fluids such as air, nitrogen, freon and other gases. What happens is that under high pressure conditions the gases will effuse into the pores of the hose tube charging them up like miniature accumulators. If the pressure is very suddenly reduced to zero the entrapped gases literally explode out of the tube often tearing holes in it. In some hose constructions a second hose tube made from a plastic such as nylon, is inserted into the hose.

A small leak will allow the gaseous fluid to seep between the two inner liners and when pressure is reduced to zero the innermost liner will collapse because the entrapped pressure around its inner diameter.

PTFE hose assembly has collapsed internally in one or more places.

One of the most common causes for this is improper handling of the PTFE assembly. PTFE is a thermoplastic material which is not rubber-like. When bent sharply it simply collapses. This type of collapse is localized in one area and is radical. When the PTFE tube is folded longitudinally in one or more places this could be the result of heat (which softens the hose) along with vacuum conditions inside of it. Because of the additional tension of the wire braid, reinforcement inherent with this type of hose, there is always a radial tension on the tube trying to push it in. Rapid cycling from a very hot agent in the hose to a very cold agent in the hose can produce the same type of failure. Danfoss Aeroquip offers an internal support coil that will eliminate this problem.

A PTFE hose assembly has developed a pin hole leak or several pin hole leaks.

This situation occurs when a petroleum based fluid, with low viscosity, is flowing at high velocity. This condition can generate high voltage use to static electricity. The high voltage is seeking a ground connection and the only ground connection available is the braided stainless steel reinforcement. This causes an electric arc, which penetrates through the PTFE tube as it travels to the reinforcement. Specially constructed PTFE tubes are available that have enough carbon black in them so as to be conductive. They will "drain off" the static electricity and preclude this problem.

Fluid connectors identification

Fluid connectors identification

Measuring Tools: A seat angle gauge, thread pitch gauge and an I.D./O.D. caliper are necessary to make accurate measurements of commonly used connectors. Danfoss offers a unique new caliper than offers the capabilities of both a caliper and a seat angle gauge in one unit.

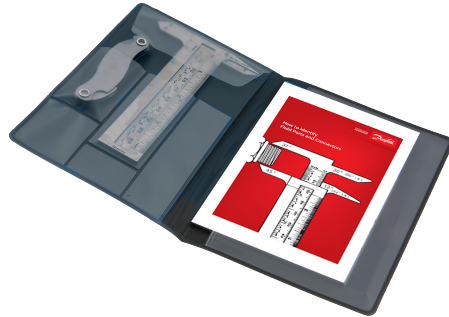

Identification Tool Kit

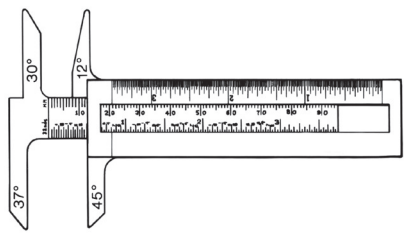

I.D./O.D. Angle gauge caliper

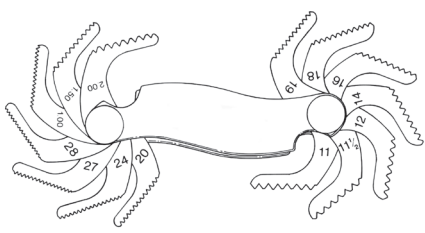

Thread pitch gauge

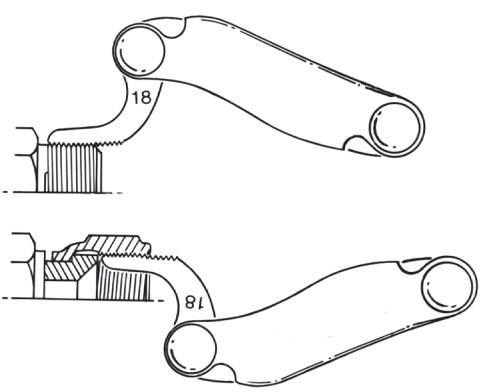

Female connections are usually measured by inserting the gauge into the connection and placing it on the sealing surface. If the centerlines of the connection and gauge are parallel, the correct angle has been determined.

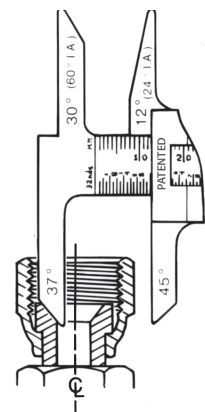

Use a thread pitch gauge to determine the number of threads per inch or the distance between threads in metric connections. Place the gauge on the threads until the fit is snug. Match the measurement to the charts.

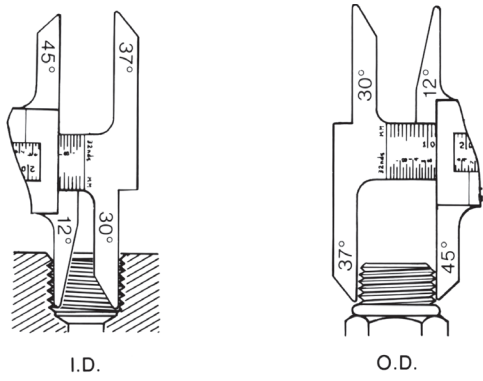

Male flare type connectors are usually measured by placing the gauge on the sealing surface. If the centerlines of the connection and gauge are parallel, the correct angle has been determined.

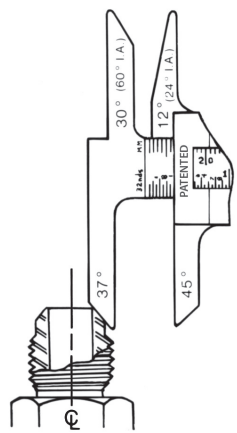

Measure the thread diameter with an I.D./O.D. caliper as shown. Match the measurements to the charts.

Thread size chart

The following chart is intended as a quick reference guide for thread size by dash size.

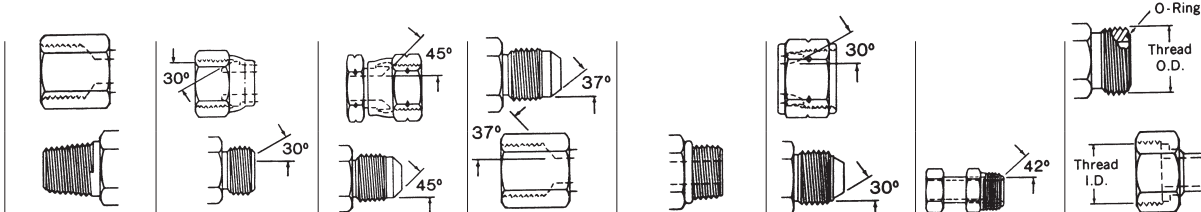

Dash size	N.P.T.F.	N.P.S.M. approx. dia.	SAE 45° auto. refrig.	SAE 37° (J.I.C.) hydraulic	SAE O-Ring boss	P.T.T. 30° automotive	SAE invert. flare	ORS
-02	1/8-27	1/8-27	5/16-24	5/16-24	5/16-24	-	5/16-24	-
-03	-	-	3/8-24	3/8-24	3/8-24	-	3/8-24	-
-04	1/4-18	1/4-18	7/16-20	7/16-20	7/16-20	-	7/16-24	9/16-18
-05	-	-	1/2-20	1/2-20	1/2-20	-	1/2-20	-
-06	3/8-18	3/8-18	5/8-18	9/16-18	9/16-18	-	5/8-18	11/16-16
-07	-	-	11/16-24	-	-	-	11/16-18	-
-08	1/2-14	1/2-14	3/4-16	3/4-16	3/4-16	-	3/4-18	13/16-16
-10	-	-	7/8-14	7/8-14	7/8-14	-	7/8-18	1-14
-12	3/4-14	3/4-14	1 1/16-14	1 1/16-12	1 1/16-12	-	1 1/16-16	1 3/16-12
-14	-	-	-	1 3/16-12	1 3/16-12	-	-	-
-16	1-11 1/2	1-11 1/2	-	1 5/16-12	1 5/16-12	1 5/16-14	-	1 7/16-12
-20	1 1/4-11 1/2	1 1/4-11 1/2	-	1 5/8-12	1 5/8-12	1 5/8-14	-	1 11/16-12
-24	1 1/2-11 1/2	1 1/2-11 1/2	-	1 7/8-12	1 7/8-12	1 7/8-14	-	2-12
-32	2-11 1/2	2-11 1/2	-	2 1/2-12	2 1/2-12	2 1/2-12	-	-
-40	2 1/2-8	2 1/2-8	-	3-12	3-12	-	-	-
-48	3-8	3-8	-	3 1/2-12	3 1/2-12	-	-	-

All dimensions are nominal. In jump size bodies, the minimum through hole dimensions will correspond to the smallest dash size.

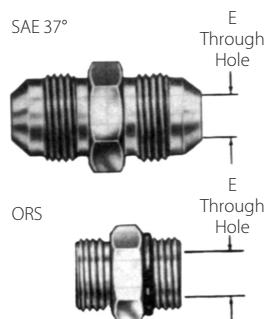

Dash size	E through hole			
	SAE 37°		ORS	
	mm	in	mm	in
-03	3,0	0.12	-	-
-04	4,3	0.17	4,3	0.17
-05	5,8	0.23	-	-
-06	7,6	0.30	6,6	0.26
-08	9,9	0.39	9,7	0.38
-10	12,2	0.48	12,2	0.48
-12	15,5	0.61	15,5	0.61
-16	21,3	0.84	20,6	0.81
-20	25,8	1.08	26,7	1.05
-24	33,3	1.31	33,3	1.31
-32	45,2	1.78	-	-

Proper tube installation

Proper tube installation

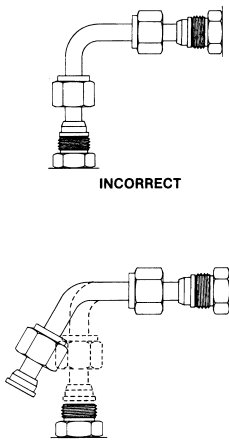

Figure 1

When compared to rigid pipe, hydraulic tubing offers the following advantages:

1. Size for size, tubing is lighter in weight, easier to handle and can be bent more easily than iron pipe.
2. Bent tubing reduces pressure drop and turbulence in the system because it eliminates sudden change in the direction of the fluid flow.
3. Hydraulic tubing reduces the number of connections required, thus reducing material and labor costs.
4. Fewer joints means lower costs and fewer points of potential leakage.
5. The use of tube fittings makes every joint a union which permits easier, faster maintenance and repair work.
6. The ORS-TF Tube Fitting eliminates the need for threading, brazing or welding.

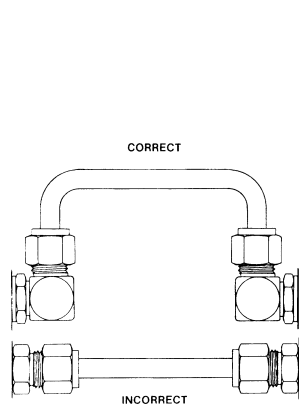

Figure 2

To reduce the number of fittings in a tube assembly, bend the tubing whenever possible.

Steel tubing can be bent in many sizes by using a hand bender designed for steel tubing. For production quantities, or for larger sizes, a power bending tool is generally used.

Contact Danfoss for additional tube bending information.

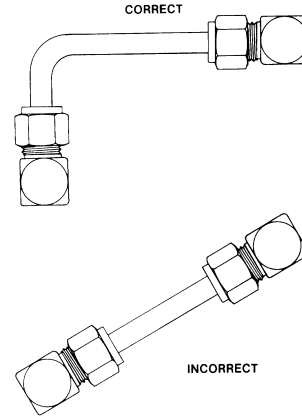

Figure 3

Tubing manufacturers will advise the correct radii for various types and wall thicknesses of tubing. Kinks, flattened bends, wrinkles and tube breakage can be avoided by the use of proper tube bending equipment.

Avoid straight line connections whenever possible, especially in short runs.

Fluid conveying systems (see figures 2, 3 and 4) should be designed to follow the contour of the equipment. They are easier to install and present a neater appearance. Long runs should be supported by brackets or clamps. All heavy systems components should be bolted or clamped to eliminate tubing fatigue.

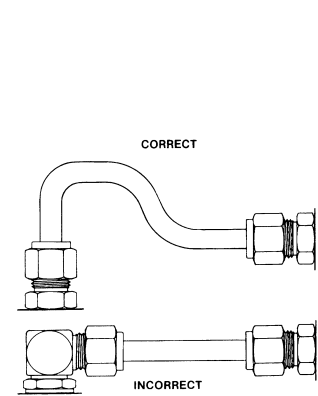

Figure 4

Inspect the tubing to see that it conforms to the required specifications before installation.

Tubes should align with the center line of the fittings, without distortion or tension. Tubing should not be sprung into position (see figure 1) to be assembled to the fitting. If this occurs the tubing has not been properly fabricated, and when installed and connected, places the tubing under stress.

Hydraulic tubing–Maximum operating pressures

SAEJ356, J524, J525, J526, J527

Tube O.D.	Dash size	Tubing wall thickness (in inches)											
		0.028		0.035		0.049		0.065		0.083		0.095	
-	-	bar	psi	bar	psi	bar	psi	bar	psi	bar	psi	bar	psi
0.19	-03	297,0	4250	375,0	5450	-	-	-	-	-	-	-	-
0.25	-04	213,0	3100	272,0	3950	396,0	5750	420,0	6000	-	-	-	-
0.31	-05	169,0	2450	213,0	3100	315,0	4500	420,0	6000	-	-	-	-
0.38	-06	140,0	2000	175,0	2550	251,0	3650	350,0	5000	420,0	6000	420,0	6000
0.50	-08	-	-	127,0	1850	186,0	2700	251,0	3650	335,0	4800	388,0	5550
0.62	-10	-	-	105,0	1500	145,0	2100	196,0	2850	258,0	3750	299,0	4350
0.75	-12	-	-	84,0	1200	122,0	1750	162,0	2350	210,0	3050	248,0	3550
1.00	-16	-	-	62,0	900	89,0	1300	122,0	1750	157,0	2250	182,0	2600
1.25	-20	-	-	-	-	70,0	1000	93,0	1350	122,0	1750	143,0	2050
1.50	-24	-	-	-	-	-	-	79,0	1150	100,0	1450	119,0	1700
2.00	-32	-	-	-	-	-	-	58,0	850	77,0	1100	87,0	1250

Tube O.D.	Dash size	Tubing wall thickness (in inches)											
		0.109		0.120		0.134		0.148		0.156		0.188	
-	-	bar	psi	bar	psi	bar	psi	bar	psi	bar	psi	bar	psi
0.19	-03	-	-	-	-	-	-	-	-	-	-	-	-
0.25	-04	-	-	-	-	-	-	-	-	-	-	-	-
0.31	-05	-	-	-	-	-	-	-	-	-	-	-	-
0.38	-06	-	-	-	-	-	-	-	-	-	-	-	-
0.50	-08	420,0	6000	420,0	6000	-	-	-	-	-	-	-	-
0.62	-10	353,0	5050	392,0	5600	-	-	-	-	-	-	-	-
0.75	-12	286,0	4150	322,0	4600	-	-	-	-	-	-	-	-
1.00	-16	210,0	3000	231,0	3350	262,0	3800	294,0	4200	-	-	-	-
1.25	-20	162,0	2350	182,0	2650	189,0	2700	203,0	2950	217,0	3100	259,0	3750
1.50	-24	134,0	1950	148,0	2150	171,0	2450	171,0	2450	182,0	2600	220,0	3150
2.00	-32	100,0	1450	112,0	1600	126,0	1800	140,0	2000	147,0	2100	178,0	2550

Maximum operating pressure ratings at specified wall thickness are based upon recommended tubing ratings per SAEJ1065 as well as limited laboratory test data. Operating pressures are based upon a 4:1 safety factor

relative to tube burst data. Danfoss recommends a maximum operating pressure of the joint which is the lesser of the tubing rating or the mating connector rating.

Recommendations: wall thickness and material

Recommended wall thickness for tube fitting applications

Tube	Dash	Versil-Flare SAE 37° flare	Versil-Flare SAE 37° flareless	ORS-BR SAE O-Ring face seal	ORS-TF SAE O-ring face seal
0.19	-03	0.028 - 0.035	0.028 - 0.035	-	-
0.25	-04	0.028 - 0.065	0.028 - 0.065	0.028 - 0.065	0.028 - 0.065
0.31	-05	0.028 - 0.065	0.028 - 0.065	-	-
0.38	-06	0.028 - 0.065	0.028 - 0.095	0.035 - 0.083	0.028 - 0.065
0.50	-08	0.035 - 0.083	0.035 - 0.120	0.035 - 0.109	0.035 - 0.120
0.62	-10	0.035 - 0.095	0.035 - 0.120	0.035 - 0.120	0.035 - 0.095
0.75	-12	0.035 - 0.109	0.035 - 0.120	0.035 - 0.120	0.049 - 0.120
1.00	-16	0.035 - 0.120	0.035 - 0.134	0.049 - 0.148	0.049 - 0.134
1.25	-20	0.049 - 0.120	0.049 - 0.188	0.049 - 0.188	0.049 - 0.156
1.50	-24	0.065 - 0.120	0.065 - 0.188	0.065 - 0.188	0.065 - 0.188
2.00	-32	0.065 - 0.134	0.065 - 0.188	-	-

Recommended hydraulic tubing material specifications

Hydraulic tubing SAE specifications			
Versil-Flare SAE 37° flare	Versil-Flare SAE 37° flareless	ORS-BR SAE O-ring face seal	ORS-TF SAE O-ring face seal
SAEJ524	SAEJ356	SAEJ356	SAEJ356
SAEJ525	SAEJ524	SAEJ524	SAEJ524
-	SAEJ525	SAEJ525	SAEJ525
-	SAEJ527	SAEJ526	SAEJ526

Hydraulic tubing material description

SAEJ356 electric resistance welded flash controlled low carbon steel, SAEJ524 seamless annealed low carbon steel, SAEJ525 electric resistance welded cold worked annealed,

SAEJ526 single wall welded low carbon steel (automotive), SAEJ527 brazed double wall low carbon steel (automotive). The maximum hardness of the above tubing should not exceed Rockwell B65.

How to measure non-threaded connections

First measure the port hole diameter using the caliper. Next, measure the longest bolt hole spacing from center-to-center or measure the flange head diameter.

Measure the male diameter with the O.D. portion of the caliper. Measure the female half by inserting the I.D. portion of the caliper into the through hole.

Most fluid piping system sizes in the United States are measured by dash numbers. These are universally used abbreviations for the size of the component expressed as the numerator of the fraction

with the denominator always being 16. For example, a -04 port is 4/16 or 1/4-inch. Dash numbers are usually nominal (in name only) and are abbreviations that make ordering of components easier.

American connections

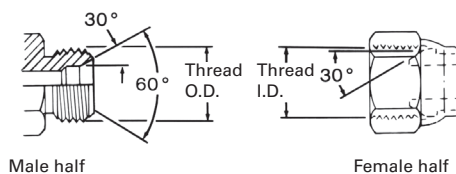
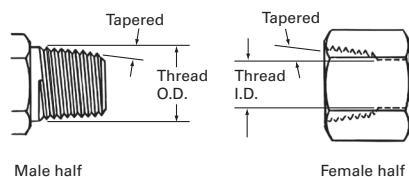

This connection is still widely used in fluid power systems, even though it is not recommended by the National Fluid Power Association (NFPA) for use in hydraulic applications. The thread

is tapered and the seal takes place by deformation of the threads.

This connection is sometimes used in fluid power systems. The female half has a straight thread and an inverted 30° seat. The male half of the connection has a straight thread and a 30° internal chamfer. The seal takes place by compression of the 30° seat on

the chamfer. The threads hold the connection mechanically.

A properly chamfered NPTF male will also seal with the NPSM female.

NPTF threads		Measure thread diameter and subtract 1/4-inch to find the nominal pipe size.				
Inch size	Dash size.	Nominal thread size	Male thread O.D. inch		Female thread I.D. inch	
			Frac.	Dec.	Frac.	Dec.
1/8	02	1/8-27	13/32	0.41	3/8	0.38
1/4	04	1/4-18	17/32	0.54	1/2	0.49
3/8	06	3/8-18	11/16	0.68	5/8	0.63
1/2	08	1/2-14	27/32	0.84	25/32	0.77
3/4	12	3/4-14	1 1/16	1.05	1	0.98
1	16	1-11 1/2	1 5/16	1.32	1 1/4	1.24
1 1/4	20	1 1/4-11 1/2	1 21/32	1.66	1 19/32	0.58
1 1/2	24	1 1/2-11 1/2	1 29/32	1.90	1 13/16	1.82
2	32	2-11 1/2	2 3/8	2.38	2 5/16	2.30

NPSM threads						
Inch size	Dash size.	Nominal thread size	Male thread O.D. inch		Female thread I.D. inch	
			Frac.	Dec.	Frac.	Dec.
1/8	02	1/8-27	13/32	0.41	3/8	0.38
1/4	04	1/4-18	17/32	0.54	1/2	0.49
3/8	06	3/8-18	11/16	0.68	5/8	0.63
1/2	08	1/2-14	27/32	0.84	25/32	0.77
3/4	12	3/4-14	1 1/16	1.05	1	0.98
1	16	1-11 1/2	1 5/16	1.32	1 1/4	1.24
1 1/4	20	1 1/4-11 1/2	1 21/32	1.66	1 19/32	0.58
1 1/2	24	1 1/2-11 1/2	1 29/32	1.90	1 13/16	1.82
2	32	2-11 1/2	2 3/8	2.38	2 5/16	2.30

American connections

American connections

SAE J1926 straight thread O-Ring boss (ORB)

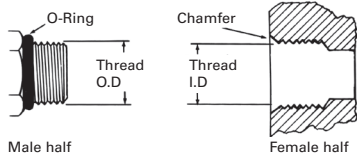

This port connection is recommended by the NFPA for optimum leakage control in medium and high pressure hydraulic systems. The male connector has a straight thread and an O-Ring. The female port has a straight thread, a machined

surface (minimum spotface) and a chamfer to accept the O-Ring. The seal takes place by compressing the O-Ring into the chamfer. The threads hold the connection mechanically.

Inch size	Dash size.	Nominal thread size	Male thread O.D. inch		Female thread I.D. inch	
			Fract.	Dec.	Fract.	Dec.
1/8	02	5/16-24	5/16	0.31	9/32	0.27
3/16	03	3/8-24	3/8	0.38	11/32	0.34
1/4	04	7/16-20	7/16	0.44	13/32	0.39
5/16	05	1/2-20	1/2	0.50	15/32	0.45
3/8	06	9/16-18	9/16	0.56	17/32	0.51
1/2	08	3/4-16	3/4	0.75	3/4	0.69
5/8	10	7/8-14	7/8	0.88	13/16	0.81
3/4	12	1 1/16-12	1 1/16	1.06	1	0.98
7/8	14	1 3/16-12	1 3/16	1.19	1 1/8	1.13
1	16	1 5/16-12	1 5/16	1.31	1 1/4	1.23
1-1/4	20	1 5/8-12	1 5/8	1.63	1 9/16	1.54
1-1/2	24	1 7/8-12	1 7/8	1.88	1 13/16	1.79
2	32	2 1/2-12	2 1/2	2.50	2 7/16	2.42

SAE J514 37° hydraulic

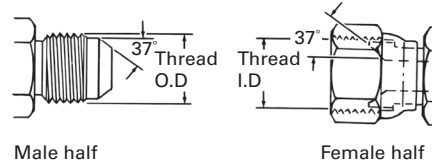

This connection is very common in fluid power systems. Both the male and female halves of the connections have 37° seats. The seal takes place by establishing a line contact between the male flare and the female cone seat. The threads

hold the connection mechanically.

Caution: In the -02, -03, -04, -05, -08 and -10 sizes, the threads of the SAE 45° flare and the SAE 37° flare are the same. However, the sealing surface angles are not the same.

Inch size	Dash size.	Nominal thread size	Male thread O.D. inch		Female thread I.D. inch	
			Fract.	Dec.	Fract.	Dec.
1/8	02	5/16-24	5/16	0.31	9/32	0.27
3/16	03	3/8-24	3/8	0.38	11/32	0.34
1/4	04	7/16-20	7/16	0.44	13/32	0.39
5/16	05	1/2-20	1/2	0.50	15/32	0.45
3/8	06	9/16-18	9/16	0.56	17/32	0.51
1/2	08	3/4-16	3/4	0.75	3/4	0.69
5/8	10	7/8-14	7/8	0.88	13/16	0.81
3/4	12	1 1/16-12	1 1/16	1.06	1	0.98
7/8	14	1 3/16-12	1 3/16	1.19	1 1/8	1.13
1	16	1 5/16-12	1 5/16	1.31	1 1/4	1.23
1-1/4	20	1 5/8-12	1 5/8	1.63	1 9/16	1.54
1-1/2	24	1 7/8-12	1 7/8	1.88	1 13/16	1.79
2	32	2 1/2-12	2 1/2	2.50	2 7/16	2.42

ORS SAE J1453 O-Ring face seal

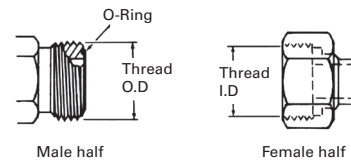

This connection offers the very best leakage control available today. The male connector has a straight thread and an O-Ring in the face. The female has a straight thread and a machined flat face.

The seal takes place by compressing the O-Ring onto the flat face of the female, similar to the split flange type fitting. The threads hold the connection mechanically.

Inch size	Dash size.	Nominal thread size	Male thread O.D. inch		Female thread I.D. inch	
			Fraction	Decimal	Fraction	Decimal
1/4	04	9/16-18	9/16	0.56	17/32	0.51
3/8	06	11/16-16	11/16	0.69	5/8	0.63
1/2	08	13/16-16	13/16	0.82	3/4	0.75
5/8	10	1-14	1	1.00	15/16	0.93
3/4	12	1 3/16-12	1 3/16	1.19	1 1/8	1.11
1	16	1 7/16-12	1 7/16	1.44	1 3/8	1.36
1-1/4	20	1 11/16-12	1 11/16	1.69	1 5/8	1.61
1-1/2	24	2-12	2	2.00	1 15/16	1.92

American connections

SAE J512 inverted

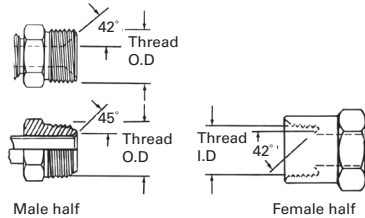

This connection is frequently used in automotive systems. The male connector can either be a 45° flare in the tube fitting form or a 42° seat in the machined adapter form.

The female has a straight thread with a 42° inverted flare. The seal takes place on the flared surfaces. The threads hold the connection mechanically.

The female has a straight thread

Inch size	Dash size	Nominal thread size	Male thread O.D. inch		Female thread I.D. inch	
			Fract.	Dec.	Fract.	Dec.
1/8	02	5/16-24	5/16	0.32	9/32	0.28
3/16	03	3/8-24	3/8	0.38	11/32	0.34
1/4	04	7/16-24	7/16	0.44	13/32	0.40
5/16	05	1/2-20	1/2	0.50	15/32	0.45
3/8	06	5/8-18	5/8	0.63	9/16	0.57
7/16	07	11/16-18	11/16	0.69	5/8	0.63
1/2	08	3/4-18	3/4	0.75	23/32	0.70
5/8	10	7/8-18	7/8	0.88	13/16	0.82
3/4	12	1 1/16-16	1 1/16	1.06	1	1.00

SAE J512 45°

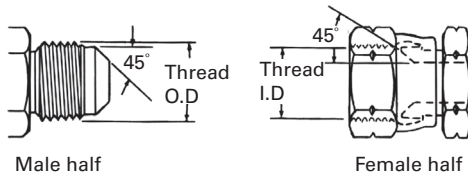

This connection is commonly used in refrigeration, automotive and truck piping systems. The connector is frequently made of brass. Both the male and female connectors have 45° seats. The seal takes place between the male flare the female

cone seat. The threads hold the connection mechanically.

Caution: In the -02, -03, -04, -05, -08 and -10 sizes, the threads of the SAE 45° flare and the SAE 37° flare are the same. However, the sealing surface angles are not the same.

Inch size	Dash size	Nominal thread size	Male thread O.D. inch		Female thread I.D. inch	
			Fract.	Dec.	Fract.	Dec.
1/8	02	5/16-24	5/16	0.31	9/32	0.27
3/16	03	3/8-24	3/8	0.38	11/32	0.34
1/4	04	7/16-20	7/16	0.44	13/32	0.39
5/16	05	1/2-20	1/2	0.50	15/32	0.45
3/8	06	5/8-18	5/8	0.63	9/16	0.57
1/2	08	3/4-16	3/4	0.75	11/16	0.69
5/8	10	7/8-14	7/8	0.88	13/16	0.81
3/4	12	1 1/16-14	1 1/16	1.06	1	0.99
7/8	14	1 1/4-12	1 1/4	1.25	1 5/32	1.16
1	16	1 3/8-12	1 3/8	1.38	1 9/32	1.29

Staplok (SAE J1467)

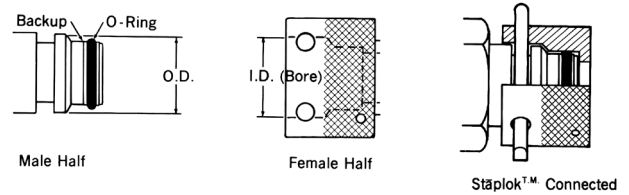

This is a radial O-Ring seal connection developed in Germany and commonly used for hydraulic application in underground mines. The male contains an exterior O-Ring and backup ring, plus a groove to accept the "staple". The female has a smooth bore

with two holes for the stable. A "U" shaped retaining clip or staple is inserted through the two holes, passing through the groove in the male to lock the connection together. The seal takes place by contact between the O-Ring in the male and the smooth bore of the female.

Inch size	Dash size	Nominal thread size	Male thread O.D. inch		Female thread I.D. inch	
			Fraction	Decimal	Fraction	Decimal
1/4	04	-	9/32	0.586	1 9/32	0.597
3/8	06	-	25/32	0.783	51/64	0.794
1/2	08	-	15/16	0.940	61/64	0.951
3/4	12	-	1 9/64	1.137	1 9/64	1.148
1	16	-	1 17/32	1.529	1 35/64	1.540
1-1/4	20	-	1 13/16	1.806	1 13/16	1.817
1-1/2	24	-	2 5/32	2.163	2 11/64	2.174
2	32	-	2 33/64	2.517	2 17/32	2.528

American connections

American connections and ISO connections

Four Bolt Flange—First measure the port hole diameter using the caliper.

Next, measure the longest bolt hole spacing from center-to-center (Dimension "A") or measure the flanged head diameter.

SAE J518 4-Bolt Flange*

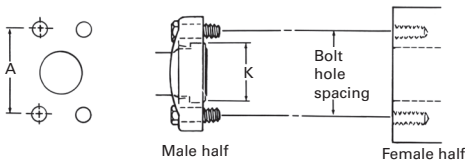

This connection is commonly used in fluid power systems. There are two pressure ratings. Code 61 is referred to as the "standard" series and Code 62 is the "6000 psi" series. The design concept for both series is the same, but the bolt hole spacing and flanged head diameters are larger for the higher pressure, Code 62 connection. The female (port) is an unthreaded hole with four bolt holes in a rectangular pattern around the port. The male consists of a flanged head,

grooved for an O-Ring, and either a captive flange or split flange halves with bolt holes to match the port. The seal takes place on the O-Ring, which is compressed between the flanged head and the flat surface surrounding the port. The threaded bolts hold the connection together.

NOTE: * SAE J518, JIS B 8363, ISO/DIS 6162 and DIN 20066 are interchangeable, except for bolt sizes.

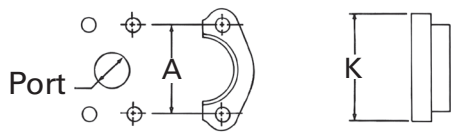

Inch Size (dash size)	Port hole I.D. inch fract. deci.	Bolt dimension inch		Bolt hole spacing "A" inch (dec)		Flanged head dia. "K" inch (dec)	
		Cd. 61	Cd. 62	Cd. 61	Cd. 62	Cd. 61	Cd. 62
1/2 (08)	1/2 (0.50)	5/16-18x1 1/4	5/16-18x1 1/4	1 1/2 (1.50)	1 19/32 (1.59)	1 3/16 (1.19)	1 1/4 (1.25)
3/4 (12)	3/4 (0.75)	3/8-16x1 1/4	3/8-16x1 1/2	1 7/8 (1.88)	2.00 (2.00)	1 1/2 (1.50)	1 5/8 (1.63)
1 (16)	1.00 (1.00)	3/8-16x1 1/4	7/16-14x1 3/4	2 1/16 (2.06)	2 1/4 (2.25)	1 3/4 (1.75)	1 7/8 (1.88)
1 1/4 (20)	1 1/4 (1.25)	7/16-14x1 1/2	1/2-13x1 3/4	2 5/16 (2.31)	2 5/8 (2.63)	2.00 (2.00)	2 1/8 (2.13)
1 1/2 (24)	1 1/2 (1.50)	1/2-13x1 1/2	5/8-11x2 1/4	2 3/4 (2.75)	3 1/8 (3.12)	2 3/8 (2.38)	2 1/2 (2.50)
2 (32)	2.00 (2.00)	1/2-13x1 1/2	3/4-10x2 3/4	3 1/16 (3.06)	3 13/16 (3.81)	2 13/16 (2.81)	3 1/8 (3.12)

ISO/DIS 6162 4-bolt flange*

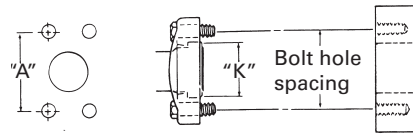

Male half

Female half

This connection is commonly used in fluid power systems. There are two pressure ratings. PN 35/350 bar (Code 61) is the "standard" series and PN 415 bar (Code 62) is the high pressure series. The design concept for both series is the same, but the bolt hole spacing and flanged head diameters are larger for the higher pressure, PN 415 bar connection. Both metric and inches bolts are used. The port will have an "M" stamped on it if metric bolts are required.

The female (port) is an unthreaded hole with four bolt holes in a rectangular pattern around the port. The male consists of a flanged head, grooved for an O-Ring, and either a captive flange or split flange halves with bolt holes to match the port. The seal takes place on the O-Ring, which is compressed between the flanged head and the flat surface surrounding the port. The threaded bolts hold the connection together.

* ISO/DIS 6162, DIN 20066, JIS B 8363 and SAE J518 are interchangeable, except for bolt sizes.

Size	Port hole	Bolt dimensions spacing		Bolt hole "A"	
		ISO 6162-1 Bar (Cd.61)	ISO 6162-2 Bar (Cd.62)	ISO 6162-1 Bar (Cd.61)	ISO 6162-2 Bar (Cd.62)
mm (dash)	mm (in)	mm (in)	mm (in)	mm (in)	mm (in)
13 (1/2) (08)	12,7 (.50)	M8 x 1.25x 30 (5/16-18 x 1-1/4)	M8 x 1.25 x 30 (5/16-18 x 1-1/4)	38.1 (1.50)	40.5 (1.57)
19 (3/4) (12)	19,1 (.75)	M10 x 1.5 x 35 (3/8-16 x 1-1/4)	M10 x 1.5 x 40 (3/8-16 x 1-1/2)	47.6 (1.88)	50.8 (2.00)
25 (1) (16)	25,4 (1.00)	M10 x 1.5 x 35 (3/8-16 x 1-1/4)	M12 x 1.75 x 45 (7/16-14 x 1-3/4)	52.4 (2.06)	57.2 (2.25)
32 (1-1/4) (20)	31,8 (1.25)	M10 x 1.5 x 40 (7/16-14 x 1-1/2)	M14 x 2 x 50 (1/2-13 x 1-3/4)	58.7 (2.31)	66.7 (2.63)
38 (1-1/2) (24)	38,1 (1.50)	M12 x 1.75 x 40 (1/2-13 x 1-1/2)	M16 x 2 x 55 (5/8-11 x 2-1/4)	69.9 (2.75)	79.4 (3.13)
51 (2) (32)	50,8 (2.00)	M12 x 1.75 x 40 (1/2-13 x 1-1/2)	M20 x 2.5 x 70 (3/4-10 x 2-3/4)	77.8 (3.06)	96.8 (3.81)

Inch size	Flanged head dia. "K"			
	ISO 6162-1 Bar (Cd.61)		ISO 6162-2 Bar (Cd.62)	
	mm	in	mm	in
1/2	30.18	1.19	31.75	1.25
3/4	38.10	1.50	41.28	1.63
1	44.45	1.75	47.63	1.88
1-1/4	50.80	2.00	53.98	2.13
1-1/2	60.33	2.38	63.50	2.50
2	71.42	2.81	79.38	3.13

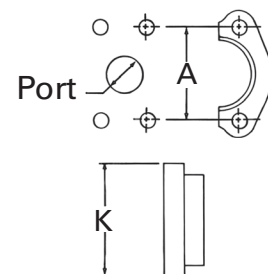

German connections

DIN 7631 series

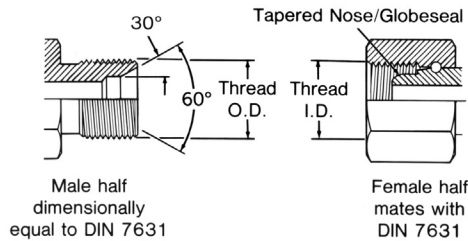

This connection is frequently used in hydraulic systems. The male has a straight metric thread and a 60° (included angle) recessed cone. The female has a straight thread and a tapered Nose/Globeseal seat. The seal takes place by contact between the cone

of the male and the nose of the tapered Nose/Globeseal flareless swivel.

The threads hold the connection mechanically.

Use with pipe/tube O.D.		Metric thread size	Male thread O.D.		Female thread I.D.	
mm	in		mm	in	mm	in
6	0.24	M12 x 1.5	12	0.47	10,5	0.41
8	0.32	M14 x 1.5	14	0.55	12,5	0.49
10	0.39	M16 x 1.5	16	0.63	14,5	0.57
12	0.47	M18 x 1.5	18	0.71	16,5	0.65
15	0.59	M22 x 1.5	22	0.87	20,5	0.81
18	0.71	M26 x 1.5	26	1.02	24,5	0.96
22	0.87	M30 x 1.5	30	1.18	28,5	1.12
28	1.10	M38 x 1.5	38	1.50	36,5	1.44
35	1.38	M45 x 1.5	45	1.77	43,5	1.71
42	1.65	M52 x 1.5	52	2.04	50,5	1.99

DIN 3902 series

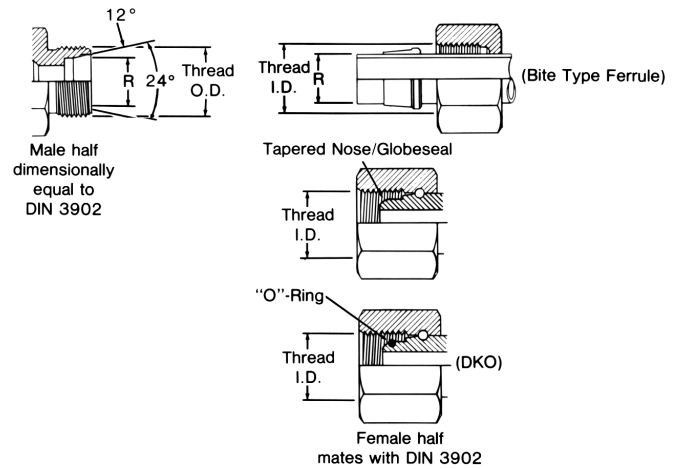

This connection style consists of a common male and three different female halves. The male has a straight metric thread, a 24° included angle and a recessed counterbore that matches the tube O.D. used with it. The female may be a tube, nut and

ferrule, a tapered nose/Globeseal flareless swivel or a tapered Nose/Globeseal flareless swivel with an O-Ring in the Nose (DKO type).

Tube O.D. "R" Dim. I.Rh.*		Tube O.D. "R" Dim. s.Rh.†		Metric thread Size	Male thread O.D.		Female thread I.D.	
mm	in.	mm	in		mm	in	mm	in
6	0.24	-	-	M12 x 1.5	12	0.47	10.5	0.41
8	0.32	6	0.24	M14 x 1.5	14	0.55	12.5	0.49
10	0.39	8	0.32	M16 x 1.5	16	0.63	14.5	0.57
12	0.47	10	0.39	M18 x 1.5	18	0.71	16.5	0.65
-	-	12	0.47	M20 x 1.5	20	0.78	18.5	0.73
15	0.59	14	0.55	M22 x 1.5	22	0.87	20.5	0.81
-	-	16	0.63	M24 x 1.5	24	0.94	22.5	0.89
18	0.71	-	-	M26 x 1.5	26	1.02	24.5	0.96
22	0.87	20	0.78	M30 x 2.0	30	1.18	28	1.11
28	1.10	25	0.98	M36 x 2.0	36	1.41	34	1.34
-	-	30	1.18	M42 x 2.0	42	1.65	40	1.57
35	1.38	-	-	M45 x 2.0	45	1.77	43	1.70
42	1.65	38	1.50	M52 x 2.0	52	2.04	50	1.97

*I.Rh. is a light duty system.
 †s.Rh. is a heavy duty system.

German connections

German connections

DIN 20066 4-bolt flange*

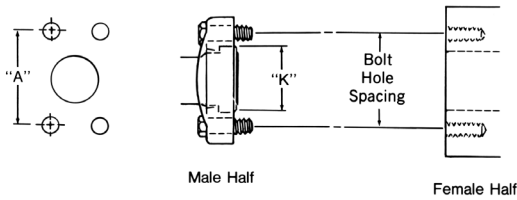

This connection is commonly used in fluid power systems. There are two pressure ratings. Form R (Code 61) is referred to as the "standard duty" series and Form S (Code 62) is the "heavy duty" series. The design concept for both series is the same, but the bolt hole spacing and flanged head diameters are larger for the higher pressure, Form S connection. Both metric and inch bolts are used. The female (port) is an unthreaded hole with four bolt holes in a rectangular pattern around the port. The male consists of a flanged head,

grooved for an O-Ring, and either a captive flange or split flange halves with bolt holes to match the port. The seal takes place on the O-Ring, which is compressed between the flanged head and the flat surface surrounding the port. The threaded bolts hold the connection together.

NOTE: *DIN 20066, IS/DIS 6166, JIS B 8363 and SAE J518 are interchangeable, except for bolt sizes.

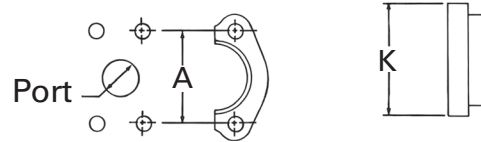

Inch size	Flanged head dia. "K"			
	Form R (Cd. 61)		Form S (Cd. 62)	
	mm	in	mm	in
1/2	30.18	1.19	31.75	1.25
3/4	38.10	1.50	41.28	1.63
1	44.45	1.75	47.63	1.88
1 1/4	50.80	2.00	53.98	2.13
1 1/2	60.33	2.38	63.50	2.50
2	71.42	2.81	79.38	3.13

Size mm (inch) (dash)	Port hole	Bolt dimensions		Bolt hole spacing	
		Form R (Cd. 61)	Form S (Cd. 62)	Form R (Cd. 61)	Form S (Cd. 62)
	mm (in)	-	-	mm (in)	mm (in)
12 (1/2) (08)	12,7 (0.50)	M8 x 1.25 x 30 5/16-18 x 1 1/4	M8 x 1.25 x 30 5/16-18 x 1 1/4	38.10 (1.50)	40.49 (1.57)
20 (3/4) (12)	19,1 (0.75)	M10 x 1.5 x 30 3/8-16 x 1 1/4	M10 x 1.5 x 40 3/8-16 x 1 1/2	47.63 (1.88)	50.80 (2.00)
25 (1) (16)	25,4 (1.00)	M10 x 1.5 x 35 3/8-16 x 1 1/4	M12 x 1.75 x 45 7/16-14 x 1 3/4	52.37 (2.06)	57.15 (2.25)
32 (1-1/4) (20)	31,7 (1.25)	M10 x 1.75 x 40 7/16-14 x 1 1/2	M14 x 2 x 45 1/2-13 x 1 3/4	58.72 (2.31)	66.68 (2.63)
40 (1-1/2) (24)	38,0 (1.50)	M12 x 1.75 x 40 1/2-13 x 1 1/2	M16 x 2 x 55 5/8-11 x 2 1/4	69.85 (2.75)	79.38 (3.13)
50 (2) (32)	50,8 (2.00)	M12 x 1.75 x 40 1/2-13 x 1 1/2	M20 x 2.5 x 70 3/4-10 x 2 3/4	77.77 (3.06)	96.82 (3.81)

German connections

DIN 3852 Male connectors and female ports

DIN 3852 metric threads				
Metric thread	Male thread O.D. "A"		Female thread I.D. "B"	
	mm	(in)	mm	(in)
M12 x 1.5	12	0.47	10,5	0.41
M14 x 1.5	14	0.55	12,5	0.49
M16 x 1.5	16	0.63	14,5	0.57
M18 x 1.5	18	0.71	16,5	0.65
M20 x 1.5	20	0.78	18,5	0.73
M22 x 1.5	22	0.87	20,5	0.81
M24 x 1.5	24	0.94	22,5	0.89
M26 x 1.5	26	1.02	24,5	0.96
M27 x 2	27	1.06	25	0.98
M30 x 1.5	30	1.18	28,5	1.12
M30 x 2	30	1.18	28	1.10
M33 x 2	33	1.30	31	1.22
M36 x 1.5	36	1.41	34,5	1.36
M36 x 2	36	1.41	34	1.33
M38 x 1.5	38	1.49	36,5	1.43
M38 x 2	38	1.49	36	1.41
M42 x 1.5	42	1.65	40,5	1.60
M42 x 2	42	1.65	40	1.57
M45 x 1.5	45	1.77	43,5	1.71
M45 x 2	45	1.77	43	1.69
M48 x 1.5	48	1.89	46,5	1.83
M48 x 2	48	1.89	46	1.81
M52 x 1.5	52	2.04	50,5	1.89
M52 x 2	52	2.04	50	1.97

For DIN 3852 Whitworth pipe thread dimensions, see BSPT/BSPP dimensions. They are the same.

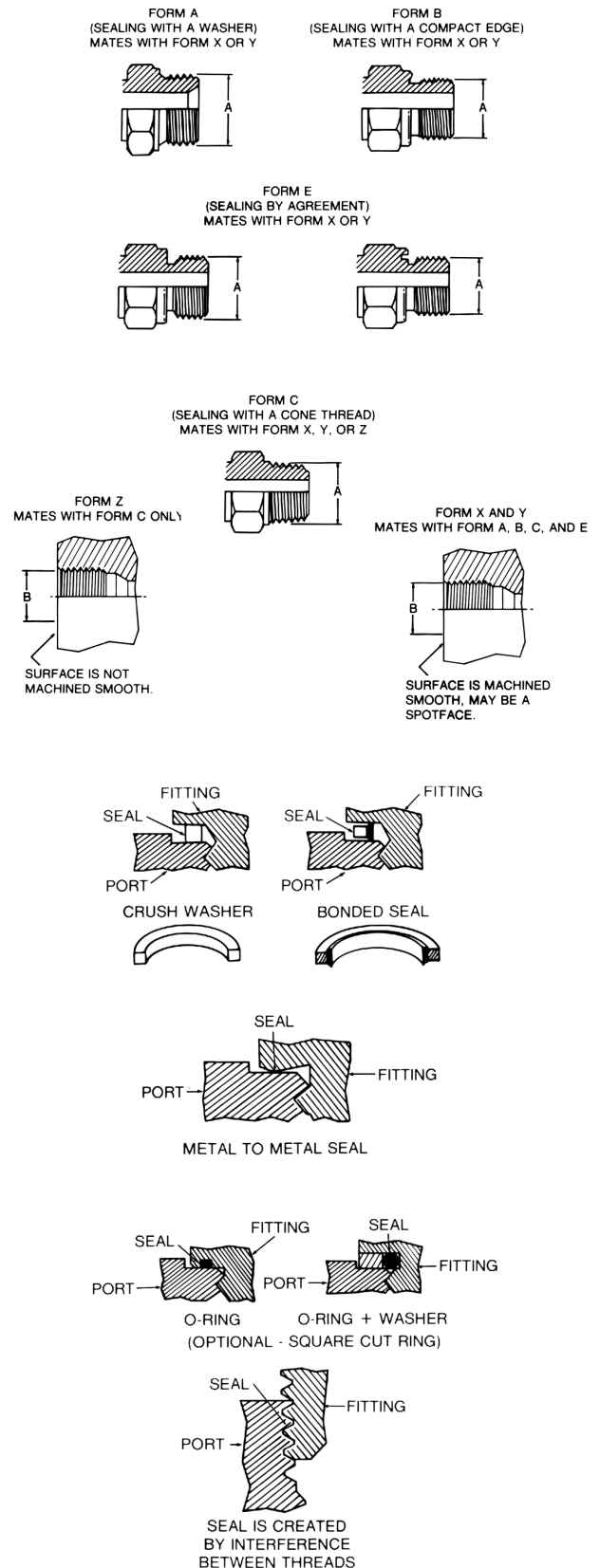

French and British connections

French & British connections

Millimetric and GAZ series

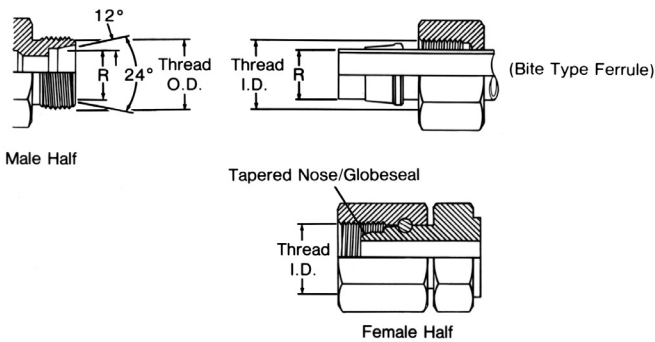

This connection consists of a common male and two different females. The millimetric series is used with whole number

metric O.D. tubing and the GAZ Series is used with fractional number metric O.D. pipe size tubing.

Millimetric and GAZ threads

Tubing O.D. "R" dim.		"GAZ" pipe O.D. R" dim.		Metric thread	Male Thread O.D. "A"		Female Thread I.D. "B"	
mm	in	mm	in		mm	(in)	mm	(in)
6	0.24	-	-	M12 x 1.5	12	0.47	11	0.43
8	0.32	-	-	M14 x 1.5	14	0.55	12.5	0.49
10	0.39	-	-	M16 x 1.5	16	0.63	14.5	0.57
12	0.47	-	-	M18 x 1.5	18	0.71	16.5	0.65
14	0.55	13.25	0.52	M20 x 1.5	20	0.78	18.5	0.73
15	0.59	-	-	M22 x 1.5	22	0.87	20.5	0.81
16	0.63	16.75	0.66	M24 x 1.5	24	0.94	22.5	0.89
18	0.71	-	-	M27 x 1.5	27	1.06	25.5	1.00
22	0.87	21.25	0.83	M30 x 1.5	30	1.18	28.5	1.12
25	0.98	-	-	M33 x 1.5	33	1.30	31.5	1.24
28	1.10	26.75	1.05	M36 x 1.5	36	1.41	34.5	1.36
30	1.18	-	-	M39 x 1.5	39	1.54	37.5	1.48
32	1.25	-	-	M42 x 1.5	42	1.65	40.5	1.60
35	1.38	33.50	1.32	M45 x 1.5	45	1.77	43.5	1.71
38	1.50	-	-	M48 x 1.5	48	1.89	46.5	1.83
40	1.57	42.25	1.66	M52 x 1.5	52	2.04	50.5	1.99
45	1.77	-	-	M54 x 2.0	54	2.12	52	2.05
-	-	48.25	1.90	M58 x 2.0	58	2.28	55	2.16

British standard pipe(BSP)

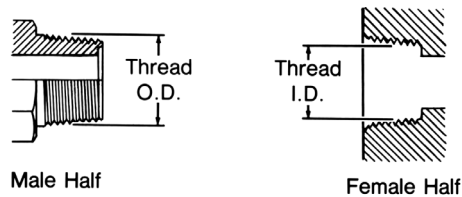

This BSPT (tapered) connection is similar to the NPT, except that the thread pitches are different in most sizes, and the thread form and O.D.s are close but not the

same. Sealing is accomplished by thread distortion. A thread sealant is recommended.

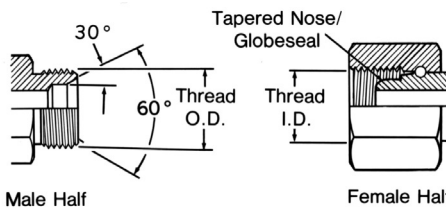

The BSP (parallel) male is similar to the NPSM male except the thread pitches are different in most sizes.

The female swivel BSPP has a tapered nose/Globeseal flareless swivel which seals on the cone seat of the male.

BSPT/BSPP threads

Inch size	Dash size	Nominal thread size	Male thread O.D. inch		Female thread I.D. inch	
			fraction	decimal	fraction	decimal
1/8	02	1/8-28	3/8	0.38	11/32	0.35
1/4	04	1/4-19	33/64	0.52	15/32	0.47
3/8	06	3/8-19	21/32	0.65	19/32	0.60
1/2	08	1/2-14	13/16	0.82	3/4	0.75
5/8	10	5/8-14	7/8	0.88	13/16	0.80
3/4	12	3/4-14	1 1/32	1.04	31/32	0.97
1	16	1-11	1 5/16	1.30	1 7/32	1.22
1 1/4	20	1 1/4-11	1 21/32	1.65	1 9/16	1.56
1 1/2	24	1 1/2-11	1 7/8	1.88	1 25/32	1.79
2	32	2-11	2 11/32	2.35	2 1/4	2.26

*Frequently, the thread size is expressed as a fractional dimension preceded by the letter "G" or the letter "R". The "G" represents a parallel thread and the "R" indicates a tapered thread. For example, BSPP 3/8-19 may be expressed as G 3/8, and BSPT 3/8-19 may be expressed as R3/8.

Japanese connections

JIS 30° male inverted seat, parallel pipe threads

(Threads per JIS B 0202)

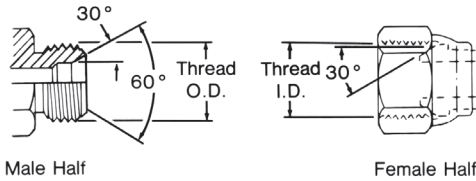

The JIS parallel is similar to the BSPP connection. The JIS parallel thread and the BSPP connection are interchangeable.

Inch size	Dash size	Nominal thread size (similar to bspp)	Male thread O.D.		Female thread O.D.	
			fract.	dec.	fract.	dec.
1/4	6 (04)	1/4-19	33/64	13.2	15/32	11.9
3/8	9 (06)	3/8-19	21/32	16.7	19/32	15.3
1/2	12 (08)	1/2-14	13/16	21.0	3/4	19.2
3/4	19 (12)	3/4-14	1 1/32	26.4	31/32	24.6
1	25 (16)	1-11	1 5/16	33.3	1 7/32	30.9
1 1/4	32 (20)	1 1/4-11	1 21/32	41.9	1 9/16	39.6
1 1/2	38 (24)	1 1/2-11	1 7/8	47.8	1 25/32	45.5
2	50 (32)	2-11	2 11/32	59.7	2 1/4	57.4

JIS 30° male inverted seat, parallel pipe threads

(Threads per JIS B 0207)

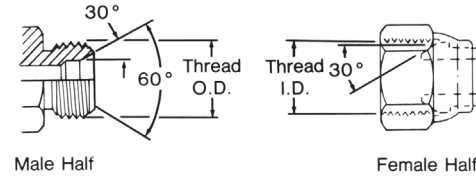

The JIS parallel (metric) is the same as the JIS parallel (PF),

except for the thread difference.

Inch size	Dash size equivalent	Thread size	Male thread O.D.		Female thread O.D.	
			fract.	dec.	fract.	dec.
6	04	M14 x 1.5	14	0.55	12.5	0.49
9	06	M18 x 1.5	18	0.71	16.5	0.65
12	08	M22 x 1.5	22	0.87	20.5	0.81
19	12	M30 x 1.5	30	1.18	28.5	1.12
25	16	M33 x 1.5	33	1.30	31.5	1.24
32	20	M42 x 1.5	42	1.65	40.5	1.60

JIS Tapered pipe (PT)

(Threads per JIS B 0203)

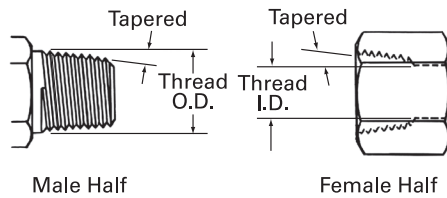

The JIS tapered thread is similar to the BSPT connection in design, appearance and dimensions. The JIS tapered thread and the BSPT connection are interchangeable.

Inch size	Dash size	Nominal thread size (similar to bspp)	Male thread O.D. inch		Female thread I.D. inch	
			fract.	dec.	fract.	dec.
1/4	6 (04)	1/4-19	33/64	13.2	15/32	11.9
3/8	9 (06)	3/8-19	21/32	16.7	19/32	15.3
1/2	12 (08)	1/2-14	13/16	21.0	3/4	19.2
3/4	19 (12)	3/4-14	1 1/32	26.4	31/32	24.6
1	25 (16)	1-11	1 5/16	33.3	1 7/32	30.9
1 1/4	32 (20)	1 1/4-11	1 21/32	41.9	1 9/16	39.6
1 1/2	38 (24)	1 1/2-11	1 7/8	47.8	1 25/32	45.5
2	50 (32)	2-11	2 11/32	59.7	2 1/4	57.4

JIS 30° female (cone) seat, parallel pipe threads (PT)

(Threads per JIS B 0202)

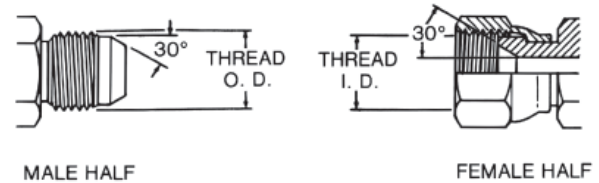

The Japanese JIS 30° flare is similar to the American SAE 37° flare connection in application as well as sealing principles. However, the

flare angle and dimensions are different. The threads are similar to BSPP.

Inch size	Dash size	Nominal thread size (similar to bspp)	Male thread O.D. inch		Female thread O.D. inch	
			fract.	dec.	fract.	dec.
1/4	6 (04)	1/4-19	33/64	13.2	15/32	11.9
3/8	9 (06)	3/8-19	21/32	16.7	19/32	15.3
1/2	12 (08)	1/2-14	13/16	21.0	3/4	19.2
3/4	19 (12)	3/4-14	1 1/32	26.4	31/32	24.6
1	25 (16)	1-11	1 5/16	33.3	1 7/32	30.9
1 1/4	32 (20)	1 1/4-11	1 21/32	41.9	1 9/16	39.6
1 1/2	38 (24)	1 1/2-11	1 7/8	47.8	1 25/32	45.5
2	50 (32)	2-11	2 11/32	59.7	2 1/4	57.4

Japanese connections

Japanese connections

JIS B 8363 4-bolt flange*

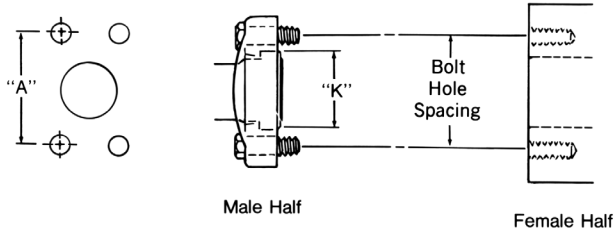

This connection is commonly used in fluid power systems. There are two pressure ratings. Type I (Code 61) is referred to as the "standard" series and Type II (Code 62) is the "6000 psi" series. The design concept for both series is the same, but the bolt hole spacing and flanged head diameters are larger for the higher pressure, Type II connection. Both metric and inch bolts are used. The female (port) is an unthreaded hole with four bolt holes in a rectangular

pattern around the port. The male consists of a flanged head, grooved for an O-Ring, and either a captive flange or split flange halves with bolt holes to match the port. The seal takes place on the O-Ring, which is compressed between the flanged head and the flat surface surrounding the port. The threaded bolts hold the connection together.

*JIS B 8363, ISO/DIS 6162, DIN 20066, and SAE J518 are interchangeable, except for bolt sizes.

Size	Port hole	Bolt dimensions		Bolt hole spacing "A"	
		Type I (Cd.61)	Type II (Cd.62)	Type I (Cd.61)	Type II (Cd.62)
mm(in) (dash)	mm(in)	mm(in)	mm(in)	mm(in)	mm(in)
12 (1/2) (08)	12,7 (0.50)	M8 x 1.25 x 30 (5/16-18 x 1-1/4)	M8 x 1.25 x 30 (5/16-18 x 1-1/4)	38.1 (1.50)	40.49 (1.57)
19 (3/4) (12)	19,1 (0.75)	M10 x 1.5 x 30 (3/8-16 x 1-1/4)	M10 x 1.5 x 40 (3/8-16 x 1-1/2)	47.63 (1.88)	50.80 (2.00)
25 (1) (16)	25,4 (1.00)	M10 x 1.5 x 30 (3/8-16 x 1-1/4)	M12 x 1.75 x 45 (7/16-14 x 1-3/4)	52.37 (2.06)	57.15 (2.25)
32 (1-1/4) (20)	31,7 (1.25)	M10 x 1.5 x 40 (7/16-14 x 1-1/2)	M14 x 2 x 45 (1/2-13 x 1-3/4)	58.72 (2.31)	66.68 (2.63)
38 (1-1/2) (24)	38,0 (1.50)	M12 x 1.75 x 40 (1/2-13 x 1-1/2)	M16 x 2 x 55 (5/8-11 x 2-1/4)	69.85 (2.75)	79.38 (3.13)
50 (2) (32)	50,8 (2.00)	M12 x 1.75 x 40 (1/2-13 x 1-1/2)	M20 x 2.5 x 70 (3/4-10 x 2-3/4)	77.77 (3.06)	96.82 (3.81)

Inch size	Flanged head dia. "K"			
	Type I bar (Cd.61)		Type II bar (Cd.62)	
	mm	in	mm	in
1/2	30,18	1.19	31,75	1.25
3/4	38,10	1.50	41,28	1.63
1	44,45	1.75	47,63	1.88
1 1/4	50,80	2.00	53,98	2.13
1 1/2	60,33	2.38	63,50	2.50
2	71,42	2.81	79,38	3.13

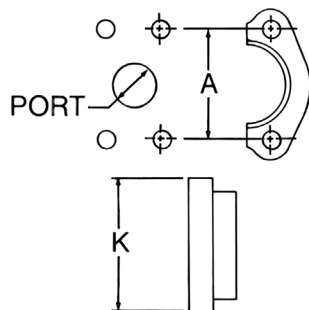

JIS 210 Kgf/cm2 4-bolt square flange

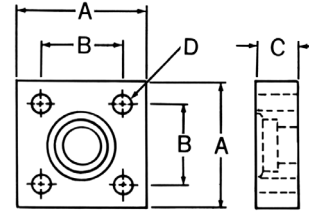

The JIS 4-bolt square flange connection is similar in concept to the SAE 4-bolt flange connection, except that the JIS bolt pattern is

square and the flange itself is different.

Size mm	Appx. inch size	Bolt size mm (bolt length for long (design))	Dim. "A" mm (inch)	Dim. "B" mm (inch)	Dim. "C" mm (inch)	Bolt hole dia "D" mm (inch)
12	1/2	M10 x 1.5 x 55 (80)	63 (2.48)	40 (1.57)	22 (0.87)	11 (0.43)
19	3/4	M10 x 1.5 x 55 (80)	68 (2.67)	45 (1.77)	22 (0.87)	11 (0.43)
25	1	M12 x 1.75 x 70 (100)	80 (3.15)	53 (2.09)	28 (1.10)	13 (0.51)
32	1 1/4	M12 x 1.75 x 70 (100)	90 (3.54)	63 (2.48)	28 (1.10)	13 (0.51)
38	1 1/2	M16 x 2.0 x 90 (130)	100 (3.94)	70 (2.76)	36 (1.42)	18 (0.71)
50	2	M16 x 2.0 x 90 (130)	112 (4.41)	80 (3.15)	36 (1.42)	18 (0.71)

JIS 210 Kgf/cm2 O-Ring

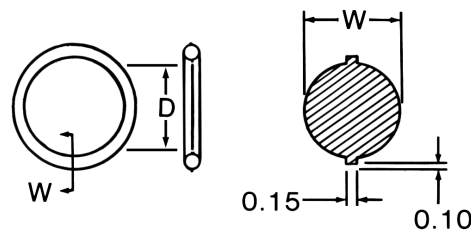

Nominal size mm	Dim. "D" mm	Dim. "W" mm
12	24.4 ± 0.15	3.1 ± 0.1
19	29.4 ± 0.15	3.1 ± 0.1
25	34.4 ± 0.15	3.1 ± 0.1
32	39.4 ± 0.15	3.1 ± 0.1
38	49.4 ± 0.15	3.1 ± 0.1
50	59.4 ± 0.15	3.1 ± 0.1

O-Ring pilot thread sizes

This connection is common to air conditioning systems, both in vehicle and commercial applications. Both the male and female halves of the connections have a pilot, either long or short. The seal takes place by compressing an O-ring adjacent to the bead of the tube. The threads hold the connection together mechanically.

Inch size	Dash size	Male thread			Female thread		
		O.D. (inch) nominal thread	O.D. (inch) fraction	O.D. (inch) decimal	I.D. (inch) nominal thread	I.D. (inch) fraction	I.D. (inch) decimal
3/8	06	5/8 - 18	5/8	0.62	5/8 - 18	9/16	0.57
1/2	08	3/4 - 18	3/4	0.75	3/4 - 16	11/16	0.69
5/8	10	7/8 - 18	7/8	0.87	7/8 - 14	13/16	0.81
3/4	12	1 1/16 - 16	1 1/16	1.06	1 1/16 - 14	1	0.99

Inch size	Dash size	Long pilot		Short pilot	
		Bead O.D.(inch)	Pilot length	Bead O.D. (inch)	Pilot length
3/8	06	0.52	0.28	0.52	0.19
1/2	08	0.64	0.39	0.64	0.19
5/8	10	0.77	0.39	0.77	0.19
3/4	12	0.91	0.39	0.91	0.19

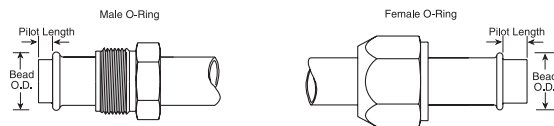

Thread engagement nominal dimensions

Thread engagement

Dimensions may vary due to tolerance conditions. Listed below are the thread engagement dimensions (B) which must be taken into consideration when making connection with ports or appropriate female adapters. The "B" dimension must be subtracted from the overall length (A) to insure proper connection.

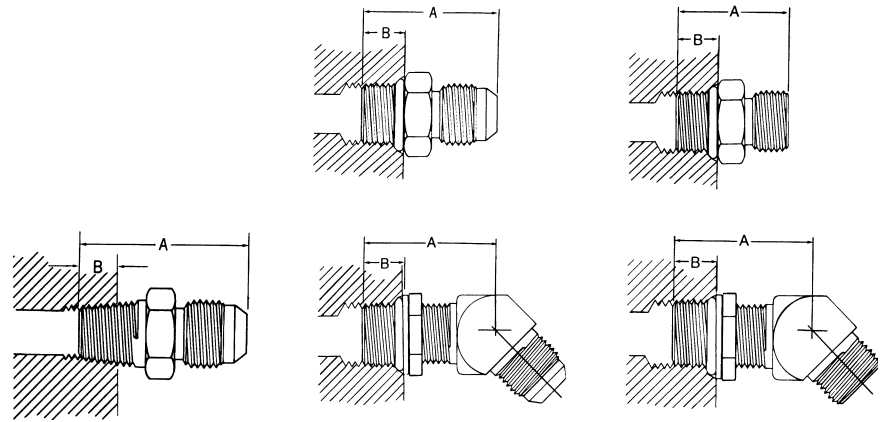

Dash size	Male pipe		SAE O-ring boss SAE J1926 with 37° flare J514		SAE O-ring boss SAE J1926 with ORS J1453	
	Straight and angled dimension "B"		Straight and adjustable dimension "B"		Straight and adjustable dimension "B"	
mm	mm	in	mm	in	mm	in
-02	6,4	0.25	-	-	-	-
-04	9,7	0.38	9,1	0.36	10,9	0.43
-05	-	-	9,1	0.36	10,9	0.43
-06	9,7	0.38	9,1	0.39	11,9	0.47
-08	12,7	0.50	10,9	0.43	14,0	0.55
-10	-	-	12,7	0.50	16,0	0.63
-12	15,7	0.62	15,0	0.59	18,5	0.73
-14	-	-	15,0	0.59	-	-
-16	17,5	0.69	15,0	0.59	18,5	0.73
-20	17,5	0.69	15,0	0.59	18,5	0.73
-24	17,5	0.69	15,0	0.59	18,5	0.73
-32	19,1	0.75	15,0	0.59	-	-

For ORS					
Dash size	Hole diameter	ORS bulkhead thickness			
		Min		Max	
	in	mm	in	mm	in
-04	0.575 +015/-0.000	5,1	0.20	12,7	0.50
-06	0.700 +015/-0.000	5,1	0.20	15,0	0.59
-08	0.825 +015/-0.000	5,6	0.22	15,0	0.59
-10	1.015 +015/-0.000	5,8	0.23	15,0	0.59
-12	1.200 +015/-0.000	6,4	0.25	15,0	0.59
-16	1.450 +015/-0.000	6,4	0.25	15,2	0.60
-20	1.715 +015/-0.000	6,4	0.25	15,2	0.60
-24	2.030 +015/-0.000	6,4	0.25	15,2	0.60

For 37° Flare									
Dash size	Hole diameter	37° bulkhead thickness straights				37° bulkhead thickness shapes			
		Min		Max		Min		Max	
	in	mm	in	mm	in	mm	in	mm	in
-03	0.391 +016/-0.000	1,3	0.05	10,4	0.41	3,3	0.13	6,4	0.25
-04	0.453 +016/-0.000	1,3	0.05	10,4	0.41	3,3	0.13	7,1	0.28
-05	0.516 +016/-0.000	1,3	0.05	10,4	0.41	3,3	0.13	7,1	0.28
-06	0.578 +016/-0.000	1,3	0.05	11,2	0.44	3,3	0.13	7,6	0.30
-08	0.766 +016/-0.000	1,3	0.05	11,2	0.44	4,1	0.16	8,6	0.34
-10	0.891 +016/-0.000	1,3	0.05	11,9	0.47	4,1	0.16	9,1	0.36
-12	1.076 +016/-0.000	1,3	0.05	11,9	0.47	4,1	0.16	9,7	0.38
-16	1.328 +016/-0.000	1,3	0.05	11,9	0.47	4,1	0.16	9,7	0.38
-20	1.656 +031/-0.000	1,3	0.05	11,9	0.47	4,1	0.16	9,7	0.38
-24	1.906 +031/-0.000	1,3	0.05	11,9	0.47	4,1	0.16	9,7	0.38

Conversion table: Inch/Millimeter

Multiply inch x 25.4 =mm

Inches		Millimeters	
Fract.	Dec.	Dec.	
1/64	0.016	0.397	
1/32	0.031	0.794	
3/64	0.047	1.191	
1/16	0.063	1.588	
5/64	0.078	1.984	
3/32	0.094	2.381	
7/64	0.109	2.778	
1/8	0.125	3.175	
9/64	0.141	3.572	
5/32	0.156	3.969	
11/64	0.172	4.366	
3/16	0.188	4.763	
13/64	0.203	5.159	
7/32	0.219	5.556	
15/64	0.234	5.953	
1/4	0.250	6.350	

Inches		Millimeters	
Fract.	Dec.	Dec.	
17/64	0.266	6.747	
9/32	0.281	7.144	
19/64	0.297	7.541	
5/16	0.313	7.938	
21/64	0.328	8.334	
11/32	0.344	8.731	
23/64	0.359	9.128	
3/8	0.375	9.525	
25/64	0.391	9.922	
13/32	0.406	10.319	
27/64	0.422	10.716	
7/16	0.438	11.113	
29/64	0.453	11.509	
15/32	0.469	11.906	
31/64	0.484	12.303	
1/2	0.500	12.700	

Inches		Millimeters	
Fract.	Dec.	Dec.	
33/64	0.516	13.097	
17/32	0.531	13.494	
35/64	0.547	13.891	
9/16	0.563	14.288	
37/64	0.578	14.684	
19/32	0.594	15.081	
39/64	0.609	15.478	
5/8	0.625	15.875	
41/64	0.641	16.272	
21/32	0.656	16.669	
43/64	0.672	17.066	
11/16	0.688	17.463	
45/64	0.703	17.859	
23/32	0.719	18.256	
47/64	0.734	18.653	
3/4	0.750	19.050	

Inches		Millimeters	
Fract.	Dec.	Dec.	
49/64	0.766	19.447	
25/32	0.781	19.844	
51/64	0.797	20.241	
13/16	0.813	20.638	
53/64	0.828	21.034	
27/32	0.844	21.431	
55/64	0.859	21.828	
7/8	0.875	22.225	
57/64	0.891	22.622	
29/32	0.906	23.019	
59/64	0.922	23.416	
15/16	0.938	23.813	
61/64	0.953	24.209	
31/32	0.969	24.606	
63/64	0.984	25.003	
1	1.000	25.400	

Conversion table: Pressure

(Per SAE J517 Section A)

Mpa	Bar	PSI
0.25	2.5	35
0.3	3	45
0.35	3.5	50
0.4	4	56
0.4	4	62
0.5	5	70
0.6	6	90
0.7	7	100
0.8	8	112
0.85	8.5	125
1	10	140
1.05	10.5	150
1.25	12.5	180
1.4	14	200
1.6	16	225
1.7	17	250
2.1	21	300
2.4	24	350
2.6	26	375
2.8	28	400
3.5	35	500
3.9	39	565

Mpa	Bar	PSI
4.2	42	600
4.3	43	625
4.9	49	700
5	50	725
5.2	52	750
5.6	56	800
6.1	61	875
7	70	1000
7.8	78	1125
8.4	84	1200
8.7	87	1250
9.8	98	1400
10	100	1450
10.5	105	1500
11.2	112	1600
11.3	113	1625
12.2	122	1750
14	140	2000
15.7	157	2250
16.8	168	2400
17.5	175	2500
19.2	192	2750

Mpa	Bar	PSI
20	200	2900
21	210	3000
22.4	224	3200
22.7	227	3250
24.5	245	3500
28	280	4000
29.7	297	4250
31.5	315	4500
33.5	335	4800
35	350	5000
38.5	385	5500
40	400	5800
42	420	6000
43.5	435	6250
45.5	455	6500
49	490	7000
52.5	525	7500
56	560	8000
59.5	595	8500
61	610	8750
63	630	9000
70	700	10000

Mpa	Bar	PSI
77	770	11000
78	780	11250
80	800	11600
84.0	840	12000
87	870	12500
98	980	14000
112	1120	16000
119	1190	17000
122	1220	17500
140	1400	20000
157	1570	22500
160	1600	23200
168	1680	24000
175	1750	25000
210	2100	30000
245	2450	35000
280	2800	40000
315	3150	45000
350	3500	50000

A new method for calculating the equivalent metric conversion to Mpa from psi was utilized. This method provides an extremely easy and consistent method of conversion to arrive at a rounded

metric units using 7 Mpa for each 1000 psi. The resulting Mpa pressure is never more than 1.7% higher than the mathematically correct Mpa unit when the pressure is higher than 250 psi. All

operating pressures of SAE J517 hoses are above 250 psi except for most of 100R4 and the 76mm (-48) and larger sizes of 100R5. Therefore all files of

previous test results should not be compromised

Assembly torque

Recommended parallel connection assembly torque

Danfoss recommends that a torque wrench be used to assure proper fitting assembly of these connections.

The values listed are for steel connections. Contact Danfoss for torque values for other materials.

Straight thread O-Ring boss low pressure with 37° (SAEJ514)

Dash size	Thread size (inches)	Jam nut or straight fitting torque lb.-ft.	Jam nut or straight fitting torque newton meters
-03	3/8-24	8-9	12-13
-04	7/16-20	13-15	18-20
-05	1/2-20	14-15	19-21
-06	9/16-18	23-24	32-33
-08	3/4-16	40-43	55-57
-10	7/8-14	43-48	59-64
-12	1 1/16-12	68-75	93-101
-14	1 3/16-12	83-90	113-122
-16	1 5/16-12	112-123	152-166
-20	1 5/8-12	146-161	198-218
-24	1 7/8-12	154-170	209-230
-32	2 1/2-12	218-240	296-325

Straight thread O-Ring boss high pressure with ORS (J1453)

Dash size	Thread size (inches)	Jam nut or straight fitting torque lb.-ft.	Jam nut or straight fitting torque newton meters
-03	3/8-24	8-10	11-13
-04	7/16-20	14-16	20-22
-05	1/2-20	18-20	24-27
-06	9/16-18	24-26	33-35
-08	3/4-16	50-60	68-78
-10	7/8-14	72-80	98-110
-12	1 1/16-12	125-135	170-183
-14	1 3/16-12	160-180	215-245
-16	1 5/16-12	200-220	270-300
-20	1 5/8-12	210-280	285-380
-24	1 7/8-12	270-360	370-490

ORS

Dash size	Thread size (inches)	Swivel nut torque lb.-ft.	Swivel nut torque newton meters
-04	9/16-18	10-12	14-16
-06	11/16-16	18-20	24-27
-08	13/16-16	32-35	43-47
-10	1-14	46-50	62-68
-12	1 3/16-12	65-70	88-95
-16	1 7/16-12	92-100	125-136
-20	1 11/16-12	125-140	170-190
-24	2-12	150-165	204-224

SAE 37° (JIC)

Dash size	Thread size (inches)	Swivel nut torque lb.-ft.	Swivel nut torque newton meters	Hex turns*
-04	7/16-20	11-12	15-16	1 1/2 - 1 3/4
-05	1/2-20	15-16	20-22	1 1/2 - 1 3/4
-06	9/16-18	18-20	24-28	1 - 1 1/2
-08	3/4-16	38-42	52-58	1 1/4 - 1 3/4
-10	7/8-14	57-62	77-85	1 1/4 - 1 3/4
-12	1 1/16-12	79-87	108-119	1 - 1 1/2
-16	1 5/16-12	108-113	148-154	3/4 - 1
-20	1 5/8-12	127-133	173-182	1/2 - 3/4
-24	1 7/8-12	158-167	216-227	3/4
-32	2 1/2-12	245-258	334-352	1

* Additional hex turns past hand tight

Recommended parallel connection assembly torque (cont.)

Danfoss recommends that a torque wrench be used to assure proper fitting assembly of these connections.

Metric		
Thread size	Straight adapter or locknut torque	
	lb.-ft.	Newton meters
mm		
M10 x 1	13-15	18-20
M12 x 1.5	15-19	20-25
M14 x 1.5	19-23	25-30
M16 x 1.5	33-40	45-55
M18 x 1.5	37-44	50-60
M20 x 1.5	52-66	70-90
M22 x 1.5	55-70	75-95
M26 x 1.5	81-96	110-130
M27 x 2	96-111	130-150
M33 x 2	162-184	220-250
M42 x 2	170-192	230-260
M48 x 2	258-347	350-470

The values listed are for steel connections. Contact Danfoss for torque values for other materials.

DKO, light series DIN 3865				
DKO, light series				
DN	O.D.	Thread	SW torque definition 8434-1	Montage [Nm[+10%]
5	6	M12X1,5	14	20
6	8	M14X1,5	17	25
8	10	M16X1,5	19	45
10	12	M18X1,5	22	50
12	15	M22X1,5	27	60
16	18	M26X1,5	32	70
20	22	M30X1,5	36	130
25	28	M36X1,5	41	180
32	35	M45X1,5	50	300
40	42	M52X1,5	60	320

BSPB		
Nominal thread size	Straight adapter or locknut torque	
	lb.-ft.	Newton meters
inches**		
G 1/8-28	13-15	18-20
G 1/4-19	19-23	25-30
G 3/8-19	33-40	45-55
G 1/2-14	55-70	75-95
G 3/4-14	103-118	140-160
G 1-11	162-184	220-250
G 1 1/4-11	170-192	230-260
G 1 1/2-11	258-347	350-470

**G* denotes parallel threads, other than ISO 6149. (Port connection only)

DKO, heavy series DIN 3865				
DKO, heavy series				
DN	O.D.	Thread	SW torque definition 8434-1	Montage [Nm[+10%]
	6	M14X1,5	17	20
5	8	M16X1,5	19	35
6	10	M18X1,5	22	50
8	12	M20X1,5	24	65
10	14	M22X1,5	27	70
12	16	M24X1,5	30	85
16	20	M30X2	36	135
20	25	M36X2	41 (46)	170
25	30	M42X2	50	280
32	38	M52X2	60	320

Assembly instructions

ORS Tube fittings, Pipe threads and SAE 37° (JIC) Flare type tube fittings

Assembly Instruction for ORS tube fittings

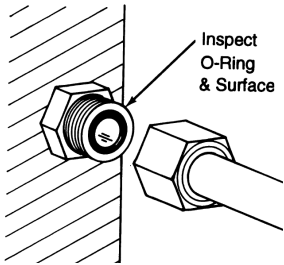

1. Inspect sealing surfaces and O-Ring groove for damage or foreign material. Check the O-Ring to insure that it is properly seated in the O-Ring groove.
2. Lubricate threads with heavy lubricant such as part number 222070 Lube.

3. Align the ORS tube fitting to the flat sealing connections and tighten the nut by hand. The nut should tighten easily by hand if properly aligned.

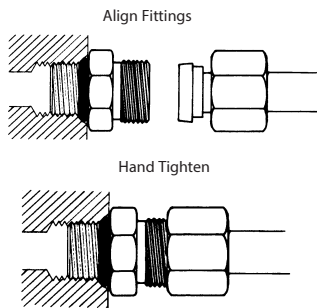

4. Complete the assembly by wrench tightening the nut to the recommended torque value on page 376.

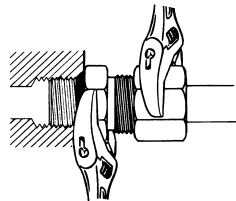

Assembly Instructions for Standard SAE 37° Flare type tube fitting

Use SAE J524 or SAE J525 tubing for best bending and flaring results.

1. Cut the tubing with a tube cutter. If a fine tooth hacksaw is used, make sure cut-off is square; remove burrs with deburring tool, emery paper or fine file. Clean all dirt and grit from the I.D. and O.D. of the tube.
2. Place the nut and then the sleeve onto tube. The threaded end of nut and flared end of sleeve must face the end of tube.

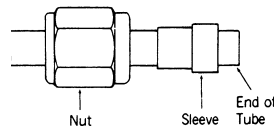

3. Flare the tube end with a flaring tool to provide a 37° flare. Check the flare for correct diameter, excessive thin out and burrs or cracks.
4. Lubricate all mating surfaces of nut, ferrule and body with a heavy lubricant such as part number 222070 Lube.
5. Assemble the nut and sleeve to body. Turn the nut hand tight then wrench tighten for a leakproof joint. See page 376, torque values, for assembly using a torque wrench.

The Danfoss standard 37° flare fitting is easy to disassemble and may be reassembled repeatedly.

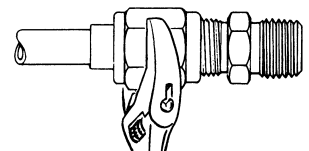

Assembly Instructions for Pipe threads

1. Assemble connection hand tight.
2. Mark male and female.
3. Rotate male; 1 1/2 turns if using thread sealant. 2 turns if not using thread sealant.

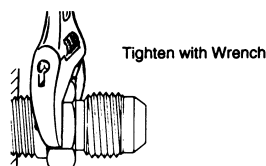
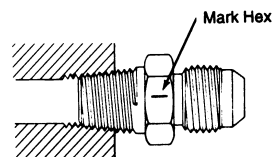
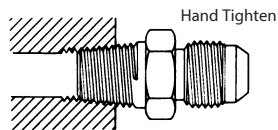

Assembly instruction tips

Terms

Skive—Removal of the cover material exposing the reinforcement prior to fitting assembly.

Dash Size—The hose or fitting size expressed in 1/16 of an inch. The numerator of a fraction whose denominator is 16. Example: -8 or -08 is $8/16" = 1/2"$.

Nipple—The part of a hose fitting that goes into the hose tube.

Socket—The part of a hose fitting that goes over the hose cover or reinforcement.

Mandrel—A round, properly sized, steel bar used for support during assembly of the fitting or skiving the hose cover.

Annular Rings—A series of concentric rings inside the socket.

Field attachable fitting tips to remember for easy assembly

Part numbers and dash sizes are indicated on fitting sockets.

It is essential the fitting be mated with a compatible hose style with the same dash size.

Field attachable fittings that have a notch in the socket serve as a reference for the cover skiving length.

Familiarize yourself with the assembly instructions before you start to make an assembly.

For hoses that require skiving, be sure to skive the hose to the proper length and down to the wire reinforcement.

Use Aeroquip 222070 hose assembly lube liberally on both the inside of the hose and on the fitting nipple. (Check for compatibility.)

Always cut hose square

For volume production of hose assemblies, use Danfoss Assembly Equipment.

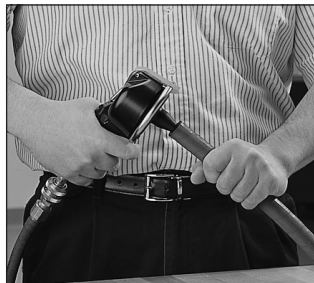

Cutting the hose

1. To determine the "J" length (cut length of hose) from "OA" (overall length) deduct "D" dimensions of both end fittings. Consult fitting information pages for "D" dimensions. For hose assemblies with SOCKETLESS[®] fittings, add 1/2" to "J" length.

Tip: If the old Aeroquip[®] assembly was the right length, simply remove the hose fittings and measure the hose.

2. Cut the hose square.
3. Clean the hose bore.

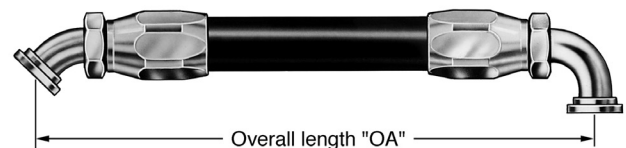
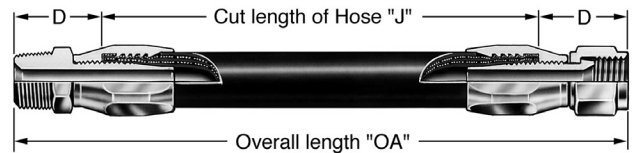

Phase angle (offset)

When making double elbow assemblies, the following steps should be followed to obtain the desired angle between elbows. Tighten both elbows to maximum allowable gap between socket and nipple hex. Start to position for relative angle between elbows. Finish assembly by adjusting both elbows. Backing off to get desired angle should be avoided.

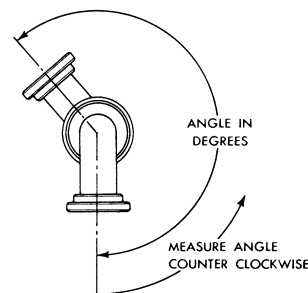

Maintenance

Cleaning, inspection, testing and storage

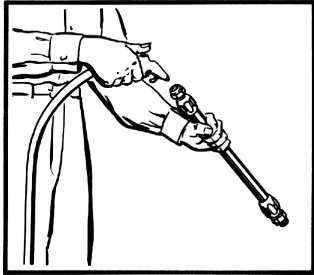

Clean



Inspect

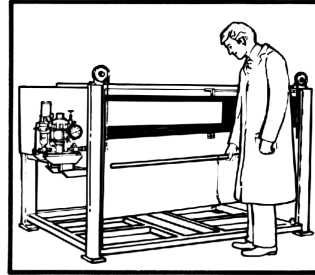

Proof test - hydrostatic

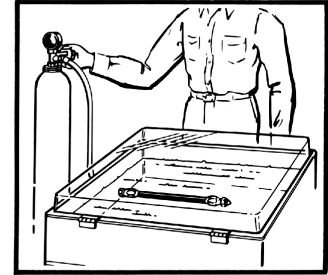

Proof test - pneumatic

Maintenance

Hose assemblies in operation should be inspected frequently for leakage, kinking, abrasion, corrosion or any other signs of wear or damage. Worn or damaged hose assemblies should be replaced immediately.

Clean

At minimum a hose assembly should be blown out with clean compressed air. Danfoss recommends using the **Danfoss Projectile Cleaning System** (FT1455 Series).

Assemblies may be rinsed out with mineral spirits if the tube stock is compatible with oil, otherwise hot water at +150°F max. may be used.

Inspect

Examine hose assembly internally for cut or bulged tube, obstructions, and cleanliness.

Check for proper gap between nut and socket or hex and socket. Nuts should swivel freely. Cap the ends of the hose with plastic covers to keep clean.

Proof test – hydrostatic

The hose assembly should be hydrostatically tested at twice the recommended working pressure of the hose.

Test pressure should be held for not more than one minute and not less than 30 seconds. When test pressure is reached, visually inspect hose assembly for: a) Any leaks or signs of weakness. b) Any movement of the hose fitting in relation to the hose. Any of these defects are cause for rejection.

(See Assembly Equipment Section for Danfoss Proof Test Stands.)

Proof test – pneumatic

Hose assemblies intended for gas or air service should be tested with air or nitrogen at 100 psi with the assembly immersed in water. Random bubbles may appear over the hose and fitting area when assembly is first pressurized. This should not be construed as a defect. However, if the bubbles persist in forming at a steady rate at any particular point on the hose, the assembly should be rejected.

Caution: Testing should be conducted in approved test stands with adequate guards to protect the operator.

Storage and handling

Hose should be stored in a dark, dry atmosphere away from electrical equipment, and the temperature should not exceed +90°F. Storage in the original shipping container is preferred.

Hose and field attachable fittings

FC510

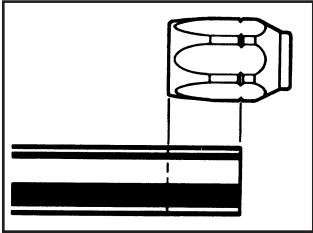

Step 1

Cut hose to length required using a cut-off wheel. Clean hose bore.

Hose must be stripped of its rubber cover before inserting in socket. Locate skiving point by putting hose end next to socket as shown. Measure from hose end to notch on socket.

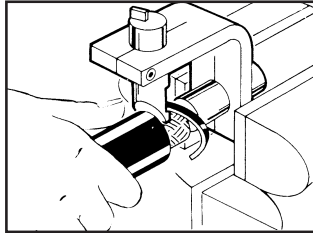

Skive Tool

Use the correct size FT1229 hose cover skiving tool. Mount the tool in a vise. Push the hose over the mandrel. Rotate the hose clockwise until it bottoms or secure hose in a vise and attach FT1279 auger to the skive tool. Insert mandrel into the hose and rotate clockwise until it bottoms.

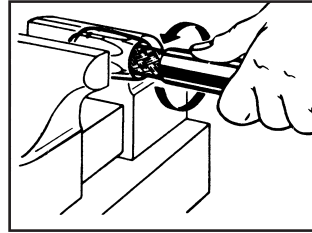

Step 2

Put socket in vise.

Screw hose into socket counterclockwise until it bottoms.

When assembling long lengths of hose, it may be preferred to put hose in vise just tight enough to prevent from turning, and screw socket onto the hose counterclockwise until it bottoms.

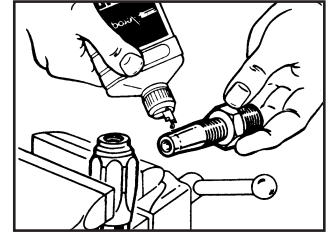

Step 3

Lubricate nipple threads and inside of hose liberally. Use heavy oil or Danfoss 222070 hose assembly lube.

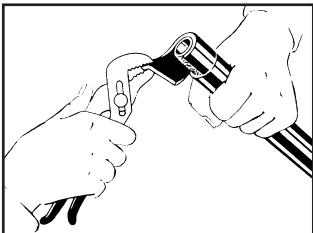

Step 1A

Skive Hose

By Hand: Cut rubber cover around down to wire reinforcement. Slit lengthwise. Raise flap and pull off with pliers. Clean excess rubber off wire reinforcement with wire brush or soft wire wheel. Do not fray or flare wire reinforcement when brushing.

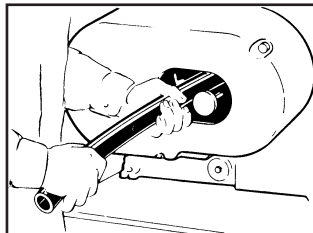

Machine

Use the S1102 cut-off and skiving machine. Consult the owners manual. Select the correct mandrel. Turn on the machine. Put the hose over the mandrel and rotate.

When skiving, remove the rubber cover until the wire reinforcement is exposed around the circumference of the hose.

Sockets for hose fittings in the -16, -24 and -32 sizes are furnished with internal annular grooves in place of helical grooves (all FC310 and FC510 hose sockets are annular grooved). Install socket by pushing hose into socket with a back and forth rocking and twisting motion until hose bottoms on shoulder of socket.

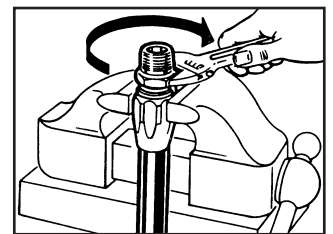

Step 4

Screw nipple clockwise into socket and hose.

Leave 1/32" to 1/16" clearance between nipple hex and socket.

Recommendations for cleaning, inspection and testing are summarized on page 380. Disassemble in reverse order.

Hose and field attachable fittings

Hose and field attachable fittings

GH493, FC736

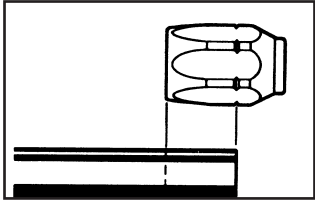

Step 1

Cut hose to length required using a cut-off wheel. Clean hose bore. Hose must be stripped of its rubber cover before inserting into socket. Locate skiving point by putting hose end next to socket as shown. Measure from hose end of socket to notch on socket.

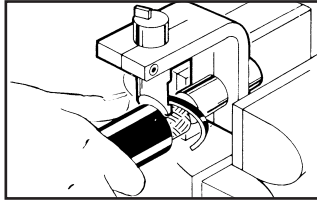

Skive Tool

Use the correct size Danfoss FT1229 hose cover skiving tool. Mount the tool in a vise. Push the hose over the mandrel. Rotate the hose clockwise until it bottoms or secure hose in a vise and attach FT1279 auger to the skive tool. Insert mandrel into the hose and rotate clockwise until it bottoms.

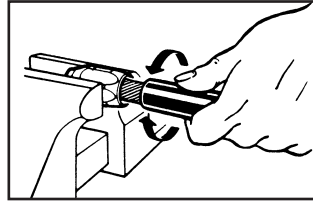

Step 2

Sockets for hose fittings are furnished with internal annular grooved design. Install socket by pushing hose into socket with a back and forth rocking and clockwise twisting motion until hose bottoms on shoulder of socket.

An alternate method is to insert the hose in a vise. Install socket by pushing onto the hose with a back and forth rocking and clockwise twisting motion until the hose bottoms on the shoulder of socket.

A rawhide hammer or similar tool may be used to tap the socket onto the hose but avoid damage to internal socket threads. Be sure not to damage hose cover or wire reinforcement.

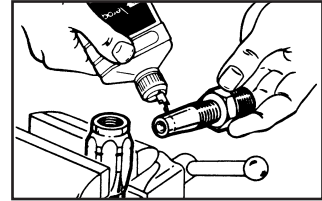

Step 3

Liberaly lubricate nipple threads and inside of hose. Use heavy weight oil or Aeroquip 222070 hose assembly lube.

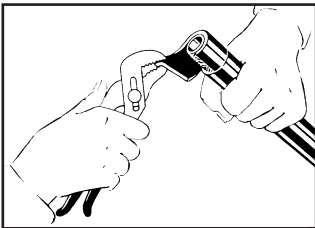

Step 1A

Skive hose by hand

Cut rubber cover around down to wire reinforcement with a knife. Slit lengthwise. Raise flap and pull off with pliers. Clean excess rubber off wire reinforcement with wire brush or soft wire wheel. Do not fray or flare wire reinforcement when brushing.

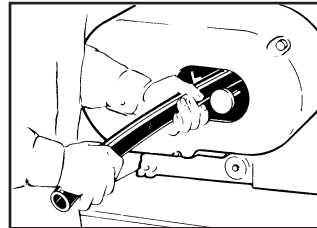

Machine

Use the Danfoss S1102 cut-off and skiving machine. Consult the owners manual. Select the correct mandrel. Turn on the machine. Put the hose over the mandrel and rotate counterclockwise.

when skiving, remove the rubber cover until the wire reinforcement is exposed around the circumference of the hose.

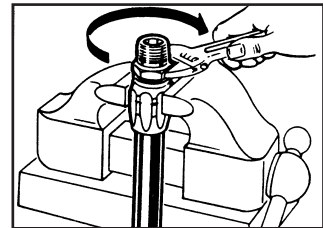

Step 4

Screw nipple clockwise into socket and hose. Leave a 1/32" to 1/16" clearance between nipple hex and socket.

Recommendations for cleaning, inspection and testing are summarized on page 380. Disassemble in reverse order.

Hose and field attachable fittings

GH681, GH781, EC115, EC215, GH663, GH793

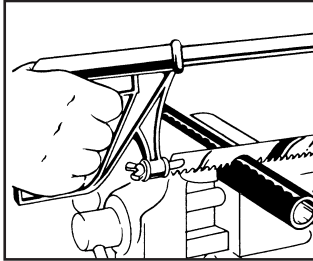

Step 1

Cut hose to length required using a cut-off machine.
Clean hose bore.

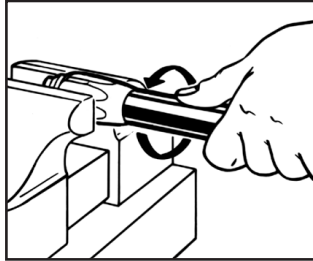

Step 2

Liberaly lubricate hose cover with Aeroquip® 222070 hose assembly lube.

Place socket in vise and turn hose into socket counterclockwise until it bottoms.

When assembling long lengths of hose, it may be preferred to put hose in vise just tight enough to prevent from turning, and screw socket onto the hose counterclockwise until it bottoms.

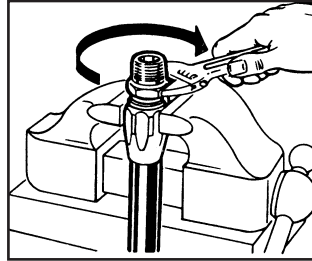

Step 3

Liberaly lubricate nipple threads and inside of hose. Use heavy weight oil or Aeroquip® 222070 hose assembly lube.

Step 4

Screw nipple clockwise into socket and hose. Leave 1/32" to 1/16" clearance between nipple hex and socket.

Recommendations for cleaning, inspection and testing are summarized on page 380.
Disassemble in reverse order.

Hose and field attachable fittings

Hose and field attachable fittings

FC234, FC300, FC321, FC350, FC355, 1503, 2580, 2651

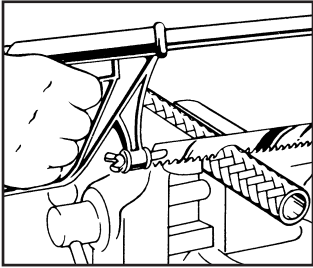

Step 1

Cut hose square to length required using a cut-off wheel. Clean hose bore.

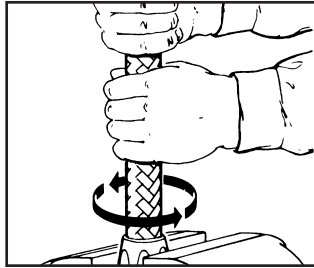

Step 2

Put socket in vise. Screw hose counterclockwise into socket until hose bottoms. Back off 1/4 turn.

When assembling long lengths of hose, it may be preferred to put hose in vise just tight enough to prevent from turning, and screw socket into the hose counterclockwise until it bottoms. Back off 1/4 turn.

Back off FC300, FC350 and FC355 hose 1/4 to 1/2 turn.

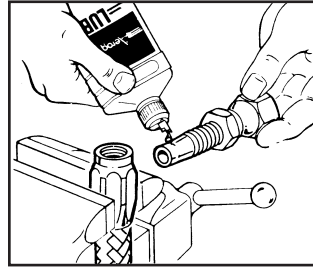

Step 3

MALE ENDS: Push assembly tool into nipple.

SWIVEL ENDS: Tighten nipple and nut on assembly tool.

Lubricate nipple, mandrel and inside of hose liberally. Use heavy oil or Danfoss 222070 hose assembly lube.

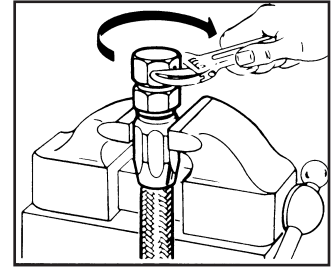

Step 4

MALE ENDS: Screw nipple clockwise into socket and hose. Leave a 1/32" to 1/16" clearance between nipple hex and socket.

SWIVEL ENDS: Screw nipple clockwise into socket and hose. Leave 1/32" to 1/16" clearance between nut and socket.

Recommendations for cleaning, inspection and testing are summarized on page 380. Disassemble in reverse order.

Accessories

900705

900564

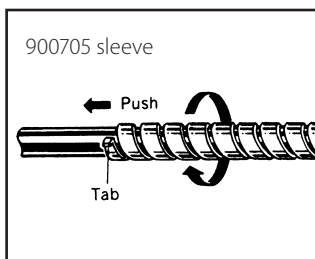

Step 1

Follow the appropriate assembly instructions through the assembly of one end fitting. Insert one end fitting in vise.

Step 2

Cut coil length. Coil should be cut to overall assembly length "OA" minus the sum of the overall length of each end fitting. ("A" dimension).

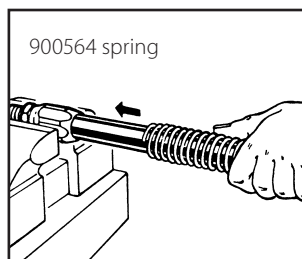

Step 3

3a) 900705 Steel Protective Coil Sleeve

The hose and the coil should be held straight. Taping or capping the hose end can prevent frayed wire ends from snagging on the coil. Bend one end to the coil outward to form a slight tab to assist grasping. (Cut off or bend back when installation is complete.) Hold the tab with the thumb of one hand while twisting the coil clockwise approximately one foot back from the coil tab. When the coil opens up

sufficiently, slip the tab end to the coil over the hose. Move the coil onto the hose by pulling at the tab end while pushing with the other hand. Be careful not to exceed the resiliency of the coil by stretching it too far.

Step 4

Proceed with assembly of second end fitting.

3b) 900564 Steel Protective Coil Spring

Slide coil over hose.

900952

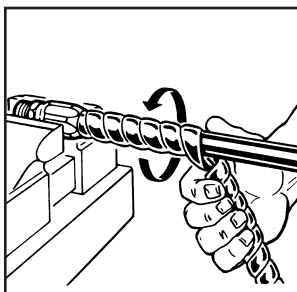

Step 1

Follow the appropriate hose assembly instructions through the assembly of both end fittings. Insert end fitting in vise.

Step 2

Cut coil length. Coil should be cut to overall assembly length "OA" minus the sum of the overall length of each end fitting. ("A" dimension).

Step 3

Wrap the coil on the hose.

Accessories

Accessories

222005, 222022

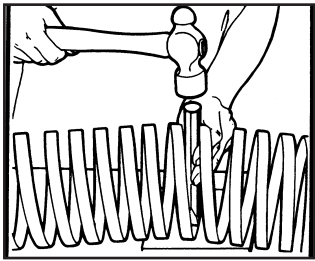

Step 1

Cut coil length. The coils should be cut to the hose length, minus the nipple intrusion. For any given hose assembly the support coil length equals the overall hose assembly length minus the sum of the overall lengths of each end fitting. ("A" dimensions.)

Small size of the coil can usually be cut with strap cutters or sheet metal shears. The larger sizes are best cut with a heavy sharp chisel or bolt cutter. With small sizes skip directly to Step 3.

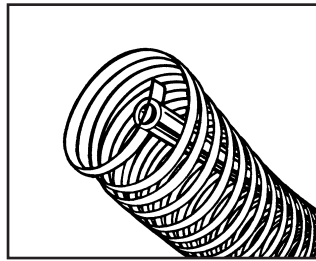

Step 2

Compress the coil (large sizes only). It is necessary to reduce the coil diameter slightly in order to insert it into the hose. The easiest approach is to use a length of pipe with a notch cut in one end. Clamp the plain end of the pipe in a vise, slide the coil over the pipe and insert the free end of the coil into the notched end of the pipe. Then clamp the coil and pipe firmly together. Twist the coil to compress it prior to installation into the hose.

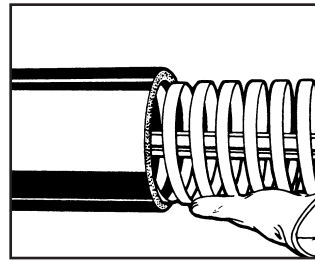

Step 3

Small sizes: The coil can be worked into the hose by hand without difficulty. Remove all burrs from the coil prior to insertion. This will prevent cutting of the hose tube. Position the coil midway between hose ends.

Large sizes: With the pipe still in position, as in Step 2, assemble the hose over the coil. With the coil fully centered in the hose, remove the pipe and clamp.

624

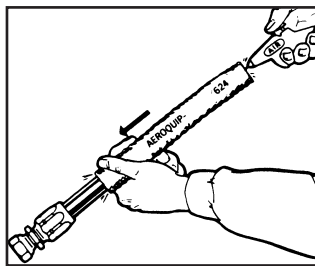

Step 1

Follow the appropriate hose assembly instructions through the assembly of one end fitting. Cut firesleeve to same length as hose; using Firesleeve End Dip (AE13702-003) dip ends of firesleeve to a depth of three quarters of an inch and allow to dry at room temperature.

Start firesleeve over cut end of hose.

If applying sleeve over PTFE or stripped cover assemblies, wrap exposed wire with tape. Grasp sleeve and slip over the hose assembly as illustrated.

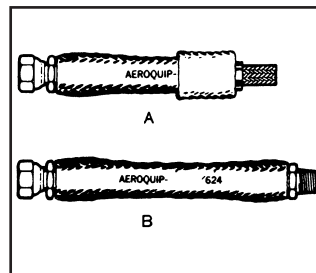

Step 2

Skin sleeve back from cut end of hose enough to allow assembly of second end fitting. (2A)
Then center sleeve so that it completely covers both sockets. (2B)

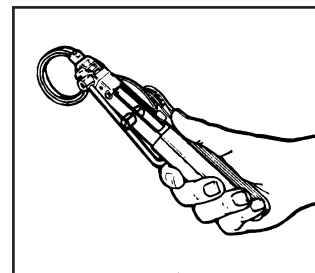

Step 3

Insert tail of band clamp into hand clamping tool.

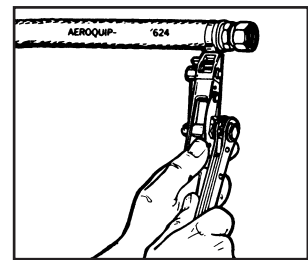

Step 4

Position band clamp over sleeve as shown and then draw tight with hand tool. Remove tool and cut free end of band clamp. Repeat on other end of assembly. To complete, bend protruding tail of clamp over clamp buckle. Also repair any scuffs or minor abrasions of firesleeve by brush application of End Dip AE13702-003.

Aeroquip by Danfoss

Glossary & index



Glossary

- abrasion:** external damage to a hose assembly caused by its being rubbed on a foreign object; a wearing away by friction.
- ABS:** Air-Brake Swivel absorption: regarding hose, the process of taking in fluid. Hose materials are often compared with regard to relative rates and total amounts of absorption as they pertain to specific fluids.
- acid resistant:** having the ability to withstand the action of identified acids within specified limits of concentration and temperature
- adapter, adaptor: 1)** fittings of various sizes and materials used to change an end fitting from one type to another type or one size to another. (i.e., a male SAE to male pipe adapter is often attached to a female SAE to create a male end union fitting); **2)** the grooved portion of a cam & groove coupling.
- adhesion:** the strength of bond between cured rubber surfaces or between a cured rubber surface and a non-rubber surface.
- adhesive:** a material which, when applied, will cause two surfaces to adhere.
- ambient temperature:** the temperature of the atmosphere or medium surrounding an object under consideration.
- ambient/atmospheric conditions:** The surrounding conditions, such as temperature, pressure, and corrosion, to which a hose assembly is exposed.
- amplitude of vibrations and/or lateral movement:** the distance a hose assembly deflects laterally to one side from its normal position, when this deflection occurs on both sides of the normal hose centerline.
- anchor:** a restraint applied to eliminate motion and restrain forces.
- annular:** refers to the convolutions on a hose that are a series of complete circles or rings located at right angles to the longitudinal axis of the hose (sometimes referred to as "bellows").
- anodize, anodized:** an electrolytic process used to deposit protective or cosmetic coatings in a variety of colors on metal; primarily used with aluminum.
- ANSI:** American National Standards Institute.
- application working pressure:** unique to customer's application. See pressure, working.
- application:** the service conditions that determine how a hose assembly will be used.
- armor:** a protective cover slid over and affixed to a hose assembly; used to prevent over bending or for the purpose of protecting hose from severe external environmental conditions such as hot materials, abrasion, or traffic.
- assembly:** a general term referring to any hose coupled with end fittings of any style attached to one or both ends.
- ASTM:** American Society for Testing and Materials.
- attachment:** the method of securing an end fitting to a hose (e.g., banding, crimping, swaging, or screw-together 2 piece or 3 piece-style field attachable fittings).
- axial movement:** compression or elongation along the longitudinal axis.
- backing:** a soft rubber layer between a hose tube and/or cover and carcass to provide adhesion.
- barb:** the portion of a fitting (coupling) that is inserted into the hose, usually comprised of two or more radial serrations or ridges designed to form a redundant seal between the hose and fitting.
- barbed and ferrule fitting:** a two-piece hose fitting comprised of a barbed insert (nipple), normally with peripheral ridges or backward-slanted barbs, for inserting into a hose and a ferrule; usually crimped or swaged.
- Barb-Tite:** a line of low pressure push-on brass hose end fittings that is a trademark of Danfoss Corporation.
- bend radius:** the radius of a bent section of hose measured to the innermost surface of the curved portion.
- bend radius, minimum:** the smallest radius at which a hose can be used. For metal hose: the radius of a bend measured to the hose centerline, as recommended by the manufacturer.
- blister:** a raised area on the surface or a separation between layers usually creating a void or air-filled space in a vulcanized article.
- blow out force:** the force generated from the internal pressure attempting to push the fitting from the hose.
- body wire:** normally a round or flat wire helix embedded in the hose wall to increase strength or to resist collapse.
- bore: 1)** an internal cylindrical passageway, as of a tube, hose or pipe; **2)** the internal diameter of a tube, hose, or pipe.
- braid:** the woven portion of a hose used as reinforcement to increase pressure rating and add hoop strength. Various materials such as polyester, cotton or metal wire are used. A hose may have one or more braids, outside or between layers of hose material.
- braid wear:** motion between the braid and corrugated hose, which normally causes wear on the outside diameter of the corrugation and the inside diameter of the braid.
- braided ply:** a layer of braided reinforcement.
- braid-over-braid:** multiple plies of braid having no separating layers.
- brand:** a mark or symbol identifying or describing a product and/or manufacturer, that is embossed, inlaid or printed.
- brass:** a family of copper/zinc alloys.
- brazing:** a process of joining metals using a non-ferrous filler metal having a melting point that is lower than the "parent metals" to be joined, typically over +800°F (+427°C).
- bronze:** an alloy of copper, tin and zinc.
- BSPP/BSPT:** British Standard Pipe Parallel / British Standard Pipe Tapered. See fitting/coupling — pipe thread fittings.
- carcass:** the fabric, cord and/or metal reinforcing section of a hose as distinguished from the hose tube or cover.
- chalking:** the formation of a powdery surface condition due to disintegration of surface binder or elastomer by weathering or other destructive environments.
- checking:** the short, shallow cracks on the surface of a rubber product resulting from damaging action of environmental conditions.
- chemical compatibility:** the relative degree to which a material may contact another without corrosion, degradation or adverse change of properties.
- chemical resistance:** the ability of a particular polymer, rubber compound, or metal to exhibit minimal physical and/or chemical property changes when in contact with one or more chemicals for a specified length of time, at specified concentrations, pressure, and temperature.
- cold flexibility:** relative ease of bending while being exposed to specified low temperature.
- collar: 1)** the portion of a fitting that is compressed by crimping to seal the hose onto the fitting barbs and create a permanent attachment; also called a ferrule. (With field attachable fittings, the lock and seal are accomplished mechanically by the collar without crimping); **2)** a raised portion on the hose shank which functions as a connection for a ferrule or other locking device or functions as a hose stop.
- collet:** a tool or die-set used to crimp a hose end fitting onto a hose. A crimping die-set is typically six to eight "fingers" designed for infinite diameter settings within a range or preset to a specific diameter for a given hose type and size. Some may have a replaceable cage.
- Coll-O-Crimp:** a line of hydraulic and pneumatic hose, hose end fittings, and fabrication equipment that is a registered trademark of Danfoss Corporation.
- combustible liquid:** a liquid having a flash point at or above +100°F (+37.8°C).

compound: the mixture of rubber or plastic and other materials, which are combined to give the desired properties when used in the manufacture of a product.

compression fitting: see fitting/coupling – compression

conductive: the ability to transfer electrical potential.

configuration: the combination of fittings on a particular assembly.

convoluted: description of hose or innercore having annular or helical ridges formed to enhance flexibility.

core: the inner portion of a hose, usually referring to the material in contact with the medium.

corrosion: the process of material degradation by chemical or electrochemical means.

corrosion resistance: ability of metal components to resist oxidation.

corrugated hose: hose with a carcass fluted, radially or helically, to enhance its flexibility or reduce its weight.

coupling: a frequently used alternative term for hose end fitting.

cover: the outer component usually intended to protect the carcass of a product.

CPE: chlorinated polyethylene, a rubber elastomer.

cracking: a sharp break or fissure in the surface, generally caused by strain and environmental conditions.

crimp diameter: the distance across opposite flats after crimping.

crimp/crimping: a hose end fitting attachment method utilizing a number of dies mounted in a radial configuration. The dies close perpendicular to the hose and fitting axis, compressing the collar, ferrule, or sleeve around the hose.

cure: the act of vulcanization. See vulcanization.

cut off factor: the hose length to be subtracted from the overall assembly length that allows for the hose coupling end connection extension beyond the end of the hose.

date code: any combination of numbers, letters, symbols or other methods used by a manufacturer to identify the time of manufacture of a product.

deburr: to remove ragged edges from the inside diameter of a hose end.

design factor: a ratio used to establish the working pressure of the hose, based on the burst strength of the hose.

displacement: the amount of motion applied to a hose defined as inches for parallel offset and degrees for angular misalignment.

DOT: Department of Transportation.

DIN: Deutsche Industrie Norme.

duplex assembly: an assembly consisting of two hose assemblies, one inside the other, and connected at the ends; also known as “jacketed assemblies.”

durometer: an instrument for measuring the hardness of rubber and plastic compounds.

eccentricity: the condition resulting from the inside and outside diameters not having a common center.

effusion: the escape, usually of gases, through a material. See permeation.

elastic limit: the limiting extent to which a body may be deformed and yet return to its original shape after removal of the deforming force.

elastomer: any one of a group of polymeric materials, usually designated thermoset, such as natural rubber, or thermoplastic, which will soften with application of heat.

elongation: the increase in length expressed numerically as a percentage of the initial length.

EN: European Normes

ERMETO: a steel fitting product trademarked by Danfoss Corporation.

endurance test: a service or laboratory test, conducted to product failure, usually under normal use conditions.

EPDM: Ethylene Propylene Diene Monomer; an elastomer.

extrude/extruded/extrusion: forced through the shaping die of an extruder; extrusion may have a solid or hollow cross section.

fabric impression: impression formed on the rubber surface during vulcanization by contact with fabric jacket or wrapper.

fabricator: the producer of hose assemblies.

fatigue: the weakening or deterioration of a material occurring when a repetitious or continuous application of stress causes strain, which could lead to failure.

FDA: United States Food and Drug Administration.

fire sleeve: slip-on or integrally extruded sleeve used to retard the effects of fire in certain applications; most often made with silicone and/or ceramic fiber.

fitting/coupling: a device attached to the end of the hose to facilitate connection. The following is only a partial list of types of fittings available.

- **banjo fitting:** a through bolted designed featuring a hollow circle or “donut” attached to one end of the fitting barb so that the inner diameter is along the hose axis.

- **compression fitting:** a fitting style that seals on a mating tube by compressing an internal ferrule against the tube O.D.

- **field attachable fitting:** a fitting designed to be attached to hose without crimping or swaging. This fitting is not always a reusable type fitting.

- **flange style fittings:** pipe flanges and flanged fitting standards are listed under ANSI B16.5. Flanges are rated for pressure and listed as “American Class 150, 300, 400, 600, 900, 1,500 or 2,500.” Pressure-temperature ratings can be obtained by consulting the ANSI specification or ASME B16.5 (American Society of Mechanical Engineers). Designs vary by neck and face style, or other dimensional changes based on use. Various finishes or grooves may be applied to the face for sealing on a gasket or o-ring. Bolt holes and other dimensions are per the ANSI standard.

- **inverted flare fitting:** a fitting consisting of a male or female nut, trapped on a tube by flaring the end of the tube material to either 37° or 45°.

- **JIC fittings:** Joint Industrial Council (no longer in existence). An engineering group that established an industry standard fitting design incorporating a 37° mating surface, male and female styles. These standards are now governed by SAE.

- **o-ring fittings:** a fitting that seals by means of an elastomeric ring of a specified material.

pipe thread fittings:

- **NPT:** National Pipe Taper. Pipe thread per ANSI B1.20.1

- **NPTF:** National Pipe Tapered for Fuels. (Same as above except dry-seal per ANSI B1.20.3)

- **NPSH:** National Pipe Straight Hose per ANSI B1.20.7

- **NPSM:** National Pipe Straight Mechanical. Straight thread per ANSI B1.20.1

- **NPSL:** National Pipe Straight Loosefit per ANSI B1.20.1

- **BSPP, BSPT:** British Standard Pipe Parallel, British Standard Pipe Taper. BS21-

- **quick connect fitting:** a fitting designed to quickly connect and disconnect. These fittings come in many styles and types.

- **split flange fitting:** a fitting consisting of a flange retainer and a flange of two halves. This design allows the flanges to be installed after the retainer has been attached to the hose, making the flange reusable. SAE code 61 and 62.

- **tube fitting:** a hose fitting of which the mating end conforms to a tube diameter. The mate or male end of a compression fitting.

flammable gases/liquid/media: a flammable gas, including liquefied gas, is one having a closed cup flash point below +100°F (+37.8°C) and a vapor pressure greater than 25 psi (174.2 KPa).

flex cracking: a surface cracking induced by repeated bending and straightening.

flow rate: a volume of media being conveyed in a given time period.

fluid: a gas or liquid medium.

fluorocarbon: an organic compound containing fluorine directly bonded to carbon. The ability of the carbon atom to form a large variety of structural chains gives rise to many fluorocarbons and fluorocarbon derivatives.

Glossary

FOR-SEAL: a product name for a hose end configuration using an o-ring sealing method, trademarked by Danfoss Corporation.

gpm: gallons per minute.

heat resistance: the property or ability to resist the deteriorating effects of elevated temperatures.

helix: a shape formed by spiraling a wire or other reinforcement around the cylindrical body of a hose; typically used in suction hose.

hose: a flexible conduit consisting of a tube, reinforcement, and usually an outer cover.

hydrostatic testing: the use of liquid pressure to test a hose or hose assembly for leakage, twisting, and/or hose change-in-length.

Hytrel: registered trademark of Chemours.

I.D.: inside diameter.

identification yarn: a yarn of single or multiple colors, usually embedded in the hose wall, used to identify the manufacturer.

impression: a design formed during vulcanization in the surface of a hose by a method of transfer, such as fabric impression or molded impression.

impulse: an application of force in a manner to produce sudden strain or motion, such as hydraulic pressure applied in a hose.

innertube: the innermost layer of a hose; the hose material in contact with the medium.

insert: optional term for nipple. See nipple.

interlocking clamp: a clamp which engages the fitting in a manner which prevents the clamp from sliding off the fitting, typically a bolt or U-bolt style with interlocking fingers which engage an interlock ring on the fitting.

interlocking ferrule: a ferrule, which physically attaches to the fitting preventing the ferrule from sliding off the fitting.

ISO: International Organization for Standardization.

jacket: a seamless tubular braided or woven ply generally on the outside of a hose.

JIC: see fitting/coupling—JIC.

kinking: a temporary or permanent distortion of the hose induced by bending beyond the minimum bend radius.

layline: the line of printed information that runs parallel on the side of a manufactured hose giving details such as part number, psi rating, hose size, and manufacturing data.

layer: a single thickness of rubber or fabric between adjacent parts.

loop installation: the assembly is installed in a loop or “U” shape, and is most often used when frequent and/or large amounts of motion are involved.

LPG, LP Gas: liquefied petroleum gas.

MAWP: see pressure, maximum allowable working.

mandrel built: a hose fabricated and/or vulcanized on a mandrel.

manufacturer’s identification: a code symbol used on or in some hose to indicate the manufacturer.

media, medium: the substance(s) being conveyed through a system.

NAHAD: National Association of Hose & Accessories Distributors.

Neoprene: a registered trademark of Chemours.

nipple: the internal member or portion of a hose fitting.

nitrile rubber (NB/Buna-N): a family of acrylonitrile elastomers used extensively for industrial hose.

nominal: a size indicator for reference only.

nomograph: a chart used to compare hose size to flow rate to recommended velocity.

non-conductive: the inability to transfer an electrical charge.

NPT/NPTF: national pipe threads. See fitting/coupling — pipe thread fittings.

nylon: a family of polyamide materials.

OAL: see overall length

O.D.: outside diameter.

OE/OEM: original equipment manufacturer.

oil resistance: the ability of the materials to withstand exposure to oil.

oil swell: the change in volume of a rubber article resulting from contact with oil.

operating conditions: the pressure, temperature, motion, and environment to which a hose assembly is subjected.

o-ring fitting: see fitting/coupling—o-ring.

overall length (OAL): the total length of a hose assembly, which consists of the free hose length plus the length of the coupling(s).

oxidation: the reaction of oxygen on a material, usually evidenced by a change in the appearance or feel of the surface or by a change in physical properties.

ozone cracking: the surface cracks, checks, or crazing caused by exposure to an atmosphere containing ozone.

ozone resistance: the ability to withstand the deteriorating effects of ozone (generally cracking).

permanent fitting: the type of fitting which, once installed, may not be removed for re-use.

permeation: the process of migration of a substance into and through another, usually the movement of a gas into and through a hose material; the rate of permeation is specific to the substance, temperature, pressure, and the material being permeated.

pin pricked: perforations through the cover of a hose to vent permeating gases.

pitch: 1) the distance from one point on a helix to the corresponding point on the next turn of the helix, measured parallel to the axis; **2)** the distance between the two peaks of adjacent corrugation or convolution.

plating: a material, usually metal, applied to another metal by electroplating, for the purpose of reducing corrosion; typically a more noble metal such as zinc is applied to steel.

ply: an individual layer in hose construction.

polymer: a macromolecular material formed by the chemical combination of monomers, having either the same or different chemical compositions.

pressure: force ÷ unit area. For purposes of this document, refers to PSIG (pounds per square inch gauge).

pressure drop: the measure of pressure reduction or loss over a specific length of hose.

pressure, burst: the pressure at which rupture occurs.

pressure, maximum allowable working: the maximum pressure at which a hose or hose assembly is designed to be used. Abbreviated as MAWP.

pressure, working: the maximum pressure to which a hose will be subjected, including the momentary surges in pressure, which can occur during service. Abbreviated as WP.

psi: pounds per square inch.

PVC: polyvinyl chloride. A low cost thermoplastic material typically used in the manufacture of industrial hoses. The operating temperature range is -500°F to +1750°F (-295.5°C to +954.4°C).

reinforcement: the strengthening members, consisting of either fabric, cord, and/or metal, of a hose. See ply.

reusable fitting/coupling: see fitting/coupling—field attachable fittings.

RMA: The Rubber Manufacturers Association, Inc.

SAE: Society of Automotive Engineers.

shank: that portion of a fitting, which is inserted into the bore of a hose.

skive: the removal of a short length of cover and/or tube to permit the attachment of a fitting directly over the hose reinforcement.

sleeve: a metal cylinder, which is not physically attached to the fitting, for the purpose of forcing the hose into the serrations of the fitting.

smooth bore: a term used to describe the type of innercore in a hose.

specification: a document setting forth pertinent details of a product.

spiral: a method of applying reinforcement in which there is not interlacing between individual strands of the reinforcement.

spring guard: a helically wound component applied internally or externally to a hose assembly, used for strain relief, abrasion resistance, collapse resistance.

standard: a document, or an object for physical comparison, for defining product characteristics, products, or processes, prepared by a consensus of a properly constituted group of those substantially affected and having the qualifications to prepare the standard for use.

static wire: wire incorporated in a hose to conduct static electricity.

stem: see nipple.

Sub-Zero: a low temperature resistant hose that is a registered trademark of Danfoss Corporation.

surge (spike): a rapid and transient rise in pressure.

swelling: an increase in volume or linear dimension of a specimen immersed in liquid or exposed to a vapor.

Thick-Flange: a hose end fitting that is trademarked by Danfoss Corporation.

tube: the innermost continuous all-rubber or plastic element of a hose.

tube fitting: see fitting/coupling—tube.

tubing: a non-reinforced, homogeneous conduit, generally of circular cross-section.

vacuum resistance: the measure of a hoses ability to resist negative gauge pressure.

vibration: amplitude motion occurring at a given frequency.

viscosity: the resistance of a material to flow.

vulcanization: a process during which a rubber compound, through a change in its chemical structure, improves or extends elastic properties over a greater range of temperature.

weathering: the surface deterioration of a hose cover during outdoor exposure, as shown by checking, cracking, crazing and chalking.

wire reinforced: a hose containing wires to give added strength, increased dimensional stability and crush resistance. See reinforcement.

working temperature: the temperature range of the application; may include the temperature of the fluid conveyed or the environmental conditions the assembly is exposed to in use.

WP: working pressure.

Index

1AAX FHXX	135	1AAX BJXX	139	1GX DSA X	123
1AAX FJAX	96	1AAX DLX	118	1GX DSB X	124
1AAX FJBX	97	1AAX FCXX	140	1GX DSX	122
1AAX FJCX	99	1AAX FLBXX	131	1GX EKX	125
1AAX FJX	94	1AAX FLDXX	132	1GX FLAX	129
1AAX FRA X	104	1AAX FLEXX	133	1GX FLB X	130
1AAX FRB X	105	1AAX FLGXX	134	1GX FLX	128
1AAX FRC X	106	1AAX KSAXX	137	1GX JFX	126
1AAX FRX	103	1AAX KSBXX	138	1GX JMX	113
1AAX FSX	101	1AAX KSXX	136	1GX KFX	127
1AAX MBX	102	1AAX MCAXX	142	1GX MCA X	142
1AAX MFA X	110	1AAX MCBXX	143	1GX SLX	108
1AAX MFB X	111	1AAX MCCXX	144	1GXX DLX	118
1AAX MFX	109	1AAX MCXX	141	1GXX FLBXX	131
1AAX MJX	100	1GAX FJAX	96	1GXX FLGXX	134
1AAX MPX	90	1GAX FJBX	97	1GXX KSAXX	137
1AAX MRX	107	1GAX FJCX	99	1GXX KSBXX	138
1AAX PFX	92	1GAX FJX	94	1GXX KSXX	136
1AAX PSX	93	1GAX FRA X	104	1GXX MCBXX	143
1AAX FJBXX	98	1GAX FRB X	105	1GXX MCXX	141
1AAX FJXX	95	1GAX FRC X	106	1RAX FJAX	147
1AAX MPXX	91	1GAX FRX	103	1RAX FJBX	148
1AX BFA X	114	1GAX FSX	101	1RAX FJCX	148
1AX BFB X	115	1GAX MBX	102	1RAX FJX	146
1AX BFX	112	1GAX MFA X	110	1RAX FRA X	149
1AX BPX	117	1GAX MFX	109	1RAX FRB X	150
1AX BTX	116	1GAX MJX	100	1RAX FRC X	150
1AX DKX	121	1GAX MPX	90	1RAX FRX	149
1AX DLA X	119	1GAX MRX	107	1RAX MJX	147
1AX DLB X	120	1GAX PFX	92	1RAX MPX	146
1AX DSA X	123	1GAX PSX	93	1S20 FH20	135
1AX DSB X	124	1GAX FJBXX	98	1SAX FJAX	96
1AX DSX	122	1GAX FJXX	95	1SAX FJBX	97
1AX EKX	125	1GAX MPXX	91	1SAX FJCX	99
1AX FLA X	129	1GX BFA X	114	1SAX FJX	94
1AX FLB X	130	1GX BFB X	115	1SAX FRA X	104
1AX FLX	128	1GX BFX	112	1SAX FRB X	105
1AX JFX	126	1GX BPX	117	1SAX FRC X	106
1AX JMX	113	1GX BTX	116	1SAX FRX	103
1AX KFX	127	1GX DKX	121	1SAX FSX	101
1AX SLX	108	1GX DLB X	120		

1SAX MBX	102	1SXX MCBXX	143	4SXX CTBXX	219
1SAX MFA X.....	110	1SXX MCCXX	144	4SXX CTDXX	220
1SAX MBFX	111	1SXX MCXX	141	4SXX CTEXX	221
1SAX MF X.....	109			4SXX CTFXX	222
1SAX MJX	100	1WXX FHA XX.....	238	4SXX CTGXX	223
1SAX MP X.....	90	1WXX FHB XX.....	239	4SXX CTXX	217
1SAX MR X.....	107	1WXX FH XX.....	238	4SXX DLB XX.....	232
1SAX PF X.....	92	1WXX MP XX.....	239	4SXX DL XX.....	231
1SAX PS X.....	93			4SXX DSA XX.....	235
1SAXX FJB XX.....	98	2RAX FJAX	152	4SXX DSB XX.....	236
1SAXX FJ XX.....	95	2RAX FJB X.....	153	4SXX DS XX.....	234
1SAXX MP XX.....	91	2RAX FJC X.....	153	4SXX EK XX.....	233
1SX BFAX	114	2RAX FJX	151	4SXX FHA XX.....	211
1SX BF FX.....	115	2RAX FRA X.....	154	4SXX FHB XX.....	212
1SX BF X.....	112	2RAX FRB 8.....	155	4SXX FHD XX.....	213
1SX BP X.....	117	2RAX FRC X.....	155	4SXX FHE XX.....	214
1SX BT X.....	116	2RAX FR X.....	154	4SXX FHF XX.....	215
1SX DK X.....	121	2RAX MJ X.....	152	4SXX FHG XX.....	216
1SX DLB X.....	120	2RAX MP X.....	151	4SXX FH XX.....	210
1SX DSA X.....	123			4SXX FLA XX.....	203
1SX DSB X.....	124	4SAX MP X.....	187	4SXX FLD XX.....	205
1SX DS X.....	122	4SAXX FJA XX.....	191	4SXX FLE XX.....	206
1SX EK XX.....	125	4SAXX FJB XX.....	192	4SXX FLF XX.....	207
1SX FLA X.....	129	4SAXX FJC XX.....	193	4SXX FLG XX.....	208
1SX FLB X.....	130	4SAXX FJG XX.....	194	4SXX FLH XX.....	209
1SX FL X.....	128	4SAXX FJ XX.....	190	4SXX FL XX.....	202
1SX JF X.....	126	4SAXX FRA XX.....	199	4SXX JF XX.....	229
1SX JM X.....	113	4SAXX FRB XX.....	200	4SXX KF XX.....	230
1SX KF X.....	127	4SAXX FRC XX.....	201		
1SX SL X.....	108	4SAXX FR XX.....	198	6SAX MP X.....	187
1SXX BJ X.....	139	4SAXX FS XX.....	196	6SAXX FJA XX.....	191
1SXX DL X.....	118	4SAXX MB XX.....	195	6SAXX FJB XX.....	192
1SXX FC XX.....	140	4SAXX MJ XX.....	189	6SAXX FJ XX.....	190
1SXX FLB XX.....	131	4SAXX MR XX.....	197	6SAXX FRA XX.....	199
1SXX FLD XX.....	132	4SAXX PS XX.....	188	6SAXX FRB XX.....	200
1SXX FLE XX.....	133	4SXX BFAX X.....	227	6SAXX FR XX.....	198
1SXX FLG XX.....	134	4SXX BF XX.....	228	6SXX BFAX X.....	227
1SXX KSAX X.....	137	4SXX BF XX.....	226	6SXX BF XX.....	228
1SXX KS BXX.....	138	4SXX BP XX.....	225	6SXX BF XX.....	226
1SXX KS XX.....	136	4SXX BT XX.....	224	6SXX CTAX X.....	218
1SXX MCA XX.....	142	4SXX CTAX X.....	218	6SXX CTB XX.....	219

Index

6SXX CTD XX.....	220	26791-XX-XXZF.....	177	ET9300C.....	308
6SXX CTE XX.....	221	222005.....	251	ET9500C.....	308
6SXX CTF XX.....	222	222022.....	251	F2015.....	299
6SXX CTG XX.....	223	222070.....	300	F2636.....	251
6SXX CT XX.....	217	900564.....	250	FC-16X.....	332
6SXX DSA XX.....	235	900705.....	250	FC254.....	65
6SXX DSB XX.....	236	900729.....	253	FC273B.....	51
6SXX DS XX.....	234	900952.....	250	FC425.....	251
6SXX FHA XX.....	211	A5950.....	255	FC500.....	50
6SXX FHB XX.....	212	C-15X.....	332	FC510.....	58
6SXX FHG XX.....	216	C-40X.....	332	FC579.....	63
6SXX FH XX.....	210	C-63X.....	332	FC606.....	67
6SXX FLA XX.....	203	C-632X.....	333	FC611.....	60
6SXX FL XX.....	202	EC115.....	78	FC619.....	72
00110-XXANZF.....	173	EC118.....	80	FC636.....	69
624.....	251	EC215.....	79	FC639.....	54
2661.....	73	EC230.....	64	FC693.....	61
03310-XXNZF.....	173	EC415.....	81	FC735.....	44
4523-04006.....	300	EC420.....	82	FC736.....	48
4573-00000.....	301	EC502.....	62	FC839B.....	40
4574-01000.....	300	EC525.....	49	FC849.....	56
14211-XX-XXZF.....	183	EC600.....	53	FC849B.....	57
15611-FXX-XXZF.....	182	EC810.....	52	FC2119-XX-449.....	244
16011-XX-XXZF.....	183	EC850.....	70	FC5130-0X0XS.....	158
16711-XX-XXZF.....	182	EC881.....	43	FC5131-0X0XS.....	158
22012.....	247	EC910.....	71	FC5133-0X0XS.....	159
22033.....	247	ET1000.....	274	FC5135-0X0XS.....	162
22046.....	248	ET1187.....	272	FC5136-XXXXS.....	163
22068.....	247	ET4001.....	284	FC5137-XXXXS.....	163
22546.....	248	ET4001P-002.....	293	FC5138-XXXXS.....	164
22617.....	247	ET5070.....	286	FC5139-XXXXS.....	164
24211D-XX-XXSMZF.....	179	ET9000.....	304	FC5140-XXXXS.....	165
24211D-XX-XXZF.....	179	ET9000C.....	309	FC5141-XXXXS.....	165
24241-XX-XXHXXTZF.....	180	ET9100.....	305	FC5142-0X0XS.....	161
24241-XX-XXHXXZF.....	180	ET9100C.....	309	FC5143-0X0XS.....	161
24291-XX-XXHXXTZF.....	181	ET9200.....	306	FC5144-0X0XS.....	160
24291-XX-XXZF.....	181	ET9200C.....	308	FC5380-0X0XS.....	162
26711D-XX-XXZF.....	175	ET9300.....	307	FC52379-XX.....	159
26711-XX-XXZF.....	174	ET9300C.....	308	FF00000.....	334
26741-XX-XXHXXZF.....	176	ET9300.....	307	FF593-XX.....	243
26791-XX-XXHXXZF.....	177			FF595-XX.....	243

Index

FF9217.....	251	FT1230.....	310	T-400-59C.....	289
FF9446.....	248	FT1231.....	310	T-400-60C.....	289
FF9807.....	248	FT1234.....	298	T-400-61C.....	289
FF9855.....	248	FT1240.....	311	T-400-66.....	289
FF9895.....	246	FT1258.....	300	T-400-MK.....	296
FF13267.....	257	FT1261.....	312	T-402-2.....	294
FF13268.....	257	FT1279.....	311	T-403-2.....	292
FF13269.....	257	FT1312.....	312	T-420.....	278
FF13270.....	257	FT1341.....	301	T-420-GT.....	296
FF13271.....	257	FT1355.....	323	T-420-KK.....	296
FF13272.....	257	FT1380.....	276	T-420-PK.....	297
FF13273.....	257	FT1380DR-12.....	333	T-421-FP.....	295
FF13570.....	257	FT1380e.....	276	T-421U.....	293
FF13571.....	257	FT1390.....	280	T-421U-110.....	293
FF16087-01.....	246	FT1455.....	314	T-441.....	294
FF17266.....	334	FT1555.....	327	T-460-2.....	292
FF90308.....	256			T-462-2.....	295
FF90311.....	253	GH120.....	46	T-480-2.....	292
FF90645.....	334	GH194.....	41	T-480-3.....	295
FF90646.....	334	GH195.....	45	T-481-110.....	293
FF90754.....	252	GH466.....	68	T-482-2.....	294
FF91420.....	334	GH493.....	47	TC-20.....	333
FF91475.....	334	GH506.....	66		
FF91610.....	334	GH663.....	55	WH004.....	83
FH-40X.....	332	GH681.....	39		
FH-72X.....	333	GH781.....	42		
FH-135X.....	332	GH793.....	59		
FJ7201-XXXXS.....	168				
FJ7202-XXXXS.....	168	HD-1X.....	333		
FJ7203-XXXXS.....	169	HD-2X.....	333		
FJ7204-XXXXS.....	169	HLM-48.....	256		
FJ9728-XXXXS.....	166	HP4.....	256		
FJ9729-XXXXS.....	166	HP6.....	256		
FJ9730-XXXXS.....	167	HP8.....	256		
FJ9731-XXXXS.....	167	HPM.....	256		
FT1028.....	298	HSM-48.....	256		
FT1033.....	298				
FT1038A.....	299	T-191.....	301		
FT1058.....	313	T-400-54C.....	289		
FT1081.....	300	T-400-56C.....	289		
FT1220-10.....	299	T-400-57C.....	289		
FT1229.....	310	T-400-58C.....	289		



ENGINEERING
TOMORROW



Danfoss Power Solutions, Nordborgvej 81, 6430 Nordborg, Denmark, Tel. +45 74 88 22 22, Fax +45 74 65 25 80
www.danfoss.com, E-mail: info@danfoss.com

Any information, including, but not limited to information on selection of product, its application or use, product design, weight, dimensions, capacity or any other technical data in product manuals, catalogues descriptions, advertisements, etc. and whether made available in writing, orally, electronically, online or via download, shall be considered informative, and is only binding if and to the extent, explicit reference is made in a quotation or order confirmation. Danfoss cannot accept any responsibility for possibly errors in catalogues, brochures, videos and other material. Danfoss reserves the right to alter its products without notice. This also applies to products ordered but not delivered provided that such alterations can be made without changes to form, fit or function of the product. All trademarks in this material are property of Danfoss A/S or Danfoss group companies. Danfoss and the Danfoss logo are trademarks of Danfoss A/S. All rights reserved.