

GB-EN



Installation instruction

DEVIreg™ 850 IV controller

www.DEVI.com

DEVI® 
by Danfoss

Table of Contents

1	User Manual	3
	1.1 System overview.	3
	1.2 General use	5
	1.3 Possible alarms during operation	7
	1.4 Changing parameters and performance of systems	8
2	Installer Manual.	10
	2.1 System overview.	10
	2.2 Placement.	11
	2.3 Connection steps for system	11
	2.4 Installation steps for system/systems.	15
	2.5 Modification of system(s)	22
3	Technical Specifications.	24
	3.1 Technical data	24
	3.2 Factory settings	25
4	Appendix	26
	A: Menu system	26
	B: How it works	31
	C: PSU and feeder cable.	35
5	Warranty	36

1 User Manual

1.1 System overview

The DEVlreg™ 850 IV system is capable of keeping outdoor areas free of ice and snow. The DEVlreg™ 850 IV can handle up to 2 independent areas, in any of the following combinations:

- **Single roof system**

To keep gutters, valley gutters and down pipes free of ice and snow, and to prevent icicles from causing damage. It is also possible to use the roof system to reduce/remove the snow weight from a roof. (**Roof system A**).

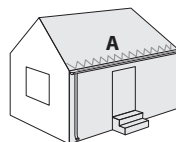

- **Single ground system**

To keep areas like parking areas, paths, garage entrances, steps, ramps, roadways and bridges free of ice and snow. (**Ground systems A**).

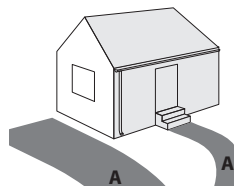

- **1 ground system and 1 roof system (combi system)**

Consists of 1 single roof system **A** and 1 single ground system **B**.

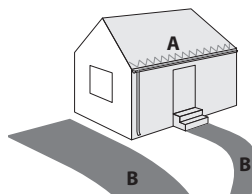

- **2 roof systems (dual system)**

Consists of 2 x "Single roof systems (**A** and **B**)".

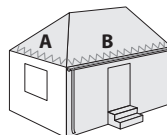

- **2 ground systems (dual system)**

Consists of 2 x "Single ground systems (**A** and **B**)".

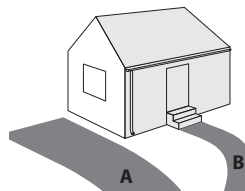

When more than 1 area is controlled by the DEVIreg™ 850 system, it is also possible to prioritize the areas. Prioritizing makes it possible to operate 2 areas, even if the needed power for 2 areas is not present.

The DEVIreg™ 850 is fully automatic and operated digitally by means of the intelligent sensors located in the heated terrain. Each sensor measures both temperature and moisture, and the system turns the heating elements on and off based on these readings. By combining moisture and temperature readings, the system is able to save around 75% energy compared to systems which only measure temperature readings. The digital sensors used for the DEVIreg™ 850 also provide the most exact readings when compared with corresponding analogue systems. The result is optimum functionality and low energy consumption.

A typical installation consists of:

- **Controller unit** (only one)

This is the device which, based on the measurements from the sensors, decides when to heat the connected area(s).

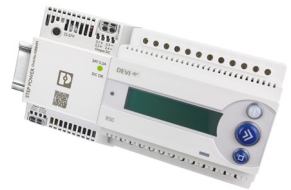

- **Power supply** (one or more)

The power supply delivers power to the controller unit and the connected sensors.

- **Ground sensor** (one or more)

At least 1 ground sensor is needed for each ground area, but to get the best performance of a system, 2 or more sensors are recommended.

For more information please refer to the sensor manual.



- **Roof sensor** (one or more)

At least 1 roof sensor is needed for each roof area, but for complex roof constructions, 2 or more sensors are recommended.

For more information please refer to the sensor manual.

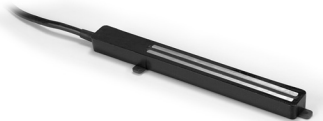



For more information about the ice and snow melting function of the DEVIreg™ 850, please refer to: Appendix B: "How it works".

1.2 General use

The DEVlreg™ 850 is operated via 3 buttons and an alpha numeric display capable of displaying information in various languages.



Buttons

The functions of the 3 buttons are:

-  Info Shows additional information / help (Only active when lit)
-  Next Next menu entry / next line / next letter
-  Enter Confirm / select



Besides the normal function of the buttons, some special combinations are important to the user:

Return to home of menu system: Hold  for 2 seconds

Master reset: Restore factory defaults AND delete installed systems (*In case of insolvable problems due to a wrong choice of language, etc.*) Hold  +  for 8 seconds

Display

The following icons have a special meaning:

-  This **animated icon** is shown, when the system is heating. When the icon is blinking the system wants to heat, but is paused (system has low priority).
-  This icon is shown, when the system has detected moisture, and the temperature is above the melting temperature.
-  This icon is shown, when the system has detected snow or ice, and the temperature is below the melting temperature.

The DEVlreg™ 850 can simultaneously control up to 2 different systems. These 2 systems are referred to as **System A** and **System B**. The DEVlreg™ 850 gives the user the opportunity to view the current status of the systems. The status can be shown in 2 different ways.

Combined view (default):

The combined view shows the status of both systems at the same time. **System A** is shown on the upper display line, and **System B** is shown on the lower display line. This view gives the user a quick overview of all the systems.



Flipped view:

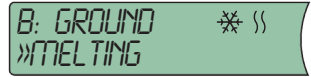
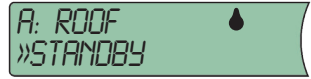

The flipped view shows the status of 1 system at a time. The status of each system is shown for 5 seconds.



This view gives the user more detailed information about each system.

The user can always press  to get more information about the current status irrespective of view selected.

Menu system

The menu system is navigated by the keys  and .

No matter if the DEVlreg™ 850 controls one or two systems, the look and use of the menu system is always the same. This is obtained by making the entry to each system in the main menu. The possibilities and settings for each system are first accessible after the user has selected the desired system.

To the right is given an example of the main menu and the menus for **System A** and **System B**.

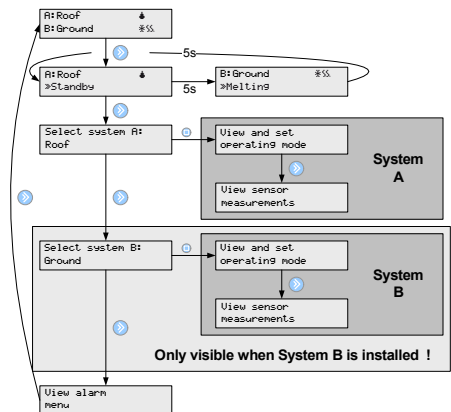

 Please note, that only a few of the menus for each system are shown!

For a complete overview of the menu system, please refer to Appendix A: "Menu system".

1.3 Possible alarms during operation

Clogged drain

Description:	<p>When clogged drain warning has been enabled, an alarm is raised when the system constantly has been detecting moisture for 14 days.</p> <p> If the DEVIreg™ 850 controls more than 1 system, and prioritizing has been enabled, the time before clogged drain warning for the down-prioritized system, can be much longer. The time is only updated, when the system actually is allowed to heat the area (e.g. the up-prioritized system is not heating)</p>
Solution:	<ul style="list-style-type: none"> - Check gutter and down pipes for any obstacles preventing the melting water to flow away. - Check if sensors are covered with dirt.

Missing sensor

Description:	<p>When the connection to a sensor is lost, the DEVIreg™ 850 alarms the user. At the same time the DEVIreg™ 850 automatically switches the system to "Constant Off" mode, and user interaction with the DEVIreg™ 850 is needed.</p>
Solution:	<ul style="list-style-type: none"> - Acknowledge error and go to "Installer Site" in the menu system and select "Change System". - Contact your local installer to get a replacement.

New sensor added

Description:	<p>When a new sensor is added, the DEVIreg™ 850 alarms the user and at the same time automatically switches to "Constant Off" mode. User interaction is needed in order to correct the error.</p>
Solution:	<p>Acknowledge error and go to "Installer Site" in the menu system and select "Change System".</p>

Sensor malfunction

Description:	<p>When something is wrong with the readings from connected sensors to the DEVIreg™ 850, an alarm is raised.</p> <p> Not all error prone sensors can be discovered using this feature!</p>
Solution:	<ul style="list-style-type: none"> - Acknowledge error and go to "Installer Site" in the menu system and select "Change System". - Contact your local service centre to get a replacement.

1.4 Changing parameters and performance of systems

Several parameters for each system can be changed during and after the installation. For a complete understanding of how these parameters affect the performance of the roof and ground system, please refer to Appendix B: "How it works".

 **Only change the DEVireg™ 850 parameters if you are aware of the effects of your actions.** Reference: Appendix A: Installer menu

Roof system

Melting temperature

Changing the melting temperature will affect when the system is activated in case of moisture and low temperatures.

The factory setting is 1.5 °C. This means that the heating system will be activated if the temperature falls below 1.5 °C and moisture is detected.

Moisture level

The "moisture level" decides when the system detects moist.

The factory setting is 50 (on a scale from 5 to 95). The lower the setting, the more sensitive the system is to moisture.

Post-heat

Once the sensor has detected that the roof/gutter is dry and free of ice and snow the system will keep heating for another hour (default). If you wish to increase/decrease this time see Appendix A: Installer menu.

The factory setting is 1 hour (on a scale from 0 to 9 hours)

Priority

When using the DEVireg™ 850 as a dual or combi system, it is possible to prioritize the systems. When the priority of 2 systems is equal, both systems can heat at the same time. If the priority of the 2 systems differs, and both systems want to heat, only the system with the highest priority is allowed to heat.

The factory setting is 1 (highest priority) for all systems.

Clogged drain

It is possible to enable and disable the "Clogged drain warning".

The factory setting is "Warning On".

System and sensor name

It is possible to change the names of the system and connected sensors (see Appendix A: Installer menu).

Ground system

Melting temperature

Changing the melting temperature will affect when the system is activated in case of moisture and low temperatures.

The factory setting is 4 °C.

This means that the heating system will be activated if the temperature falls below 4 °C and moisture is detected.

Standby temperature (maintained ground temperature)

The higher the standby temperature the faster the system will be able to melt ice and snow. On the other hand the higher the standby temperature the higher the running costs. So, determining the standby temperature is a trade-off between fast melting or low running costs.

The factory setting is -3 °C.

Moisture level

The “moisture level” decides when the system detects moist.

The factory setting is 50 (on a scale from 5 to 95).

The lower the setting, the more sensitive the system is to moisture.

Post-heat

Once the sensor has detected that the roof/gutter is dry and free of ice and snow the system will keep heating for another hour (default). If you wish to increase/decrease this time see Appendix A: Installer menu.

The factory setting is 1 hour (on a scale from 0 to 9 hours)

Priority

When using the DEVIreg™ 850 as a dual or combi system, it is possible to prioritize the systems. When the priority of 2 systems is equal, both systems can heat at the same time. If the priority of the 2 systems differs, and both systems want to heat, only the system with the highest priority is allowed to heat.

The factory setting is 1 (highest priority) for all systems.

Clogged drain

It is possible to enable and disable the “Clogged drain warning”.

The factory setting is “Warning On”.

System and sensor name

It is possible to change the names of the system and connected sensors.

2 Installer Manual

2.1 System overview

The DEVIreg™ 850 can handle up to 2 independent areas, in any of the following combinations:

- **Single roof system**
(1 system, 1–4 roof sensors)
- **Single ground system**
(1 system, 1–4 roof sensors).
- **1 ground system and 1 roof system** (combi system)
(2 systems, 2–4 sensors total, minimum 1 sensor per system).
- **2 roof systems** (dual system)
(2 systems, 2–4 sensors total, minimum 1 sensor per system).
- **2 ground systems** (dual system)
(2 systems, 2–4 sensors total, minimum 1 sensor per system).



When more than 1 area is controlled by the DEVIreg™ 850 system, it is also possible to prioritize the areas. Prioritizing makes it possible to operate 2 areas, even if the needed power for 2 areas is not present.

A typical ice and snow melting system consists of:

- **DEVIreg™ 850**
 - Only 1 DEVIreg™ 850 is allowed on the DEVIbus™.
- **Power supply**
 - More power supplies can be connected in parallel (if needed)
 - Be aware of maximum number of sensors on each power supply (Refer to Technical Specification for power demand of sensors).
- **Ground and/or roof sensor(s)**
 - Be aware of maximum number and cable length of sensors on each power supply (Refer to sensor manual for a more detailed description).

2.2 Placement



The DEVlreg™ 850 and power supply are designed for DIN rail mounting. When mounting please be aware of the following conditions:

-  The DEVlreg™ 850 is designed and approved to operate in the temperature range -10 °C to 40 °C .
-  The DEVlreg™ 850 is only IP20 protected, thus not water resistant.
-  The installer must ensure proper enclosure of the DEVlreg™ 850 according to national standards (electrical safety).

2.3 Connection steps for system

-  Only authorized personnel is allowed to install the DEVlreg™ 850.

When wiring up the DEVlreg™ 850 and sensors, please be aware of the following conditions:

-  When the DEVlreg™ 850 is used in a dual system configuration, it is preferable that each sensor bus (DEVlbus™) can be connected and disconnected via switches. During the installation of a dual system, each system must be connected one at a time.
-  Be aware of maximum allowable power drain from power supply to sensors.

Below is shown the recommended order of the installation. Please refer to figure A for connection of DEVlreg™ 850 and refer to figure B–G for a guideline to connect the heating elements to DEVlreg™ 850.

1. Connect heating cables to the DEVlreg™ 850
 - Please notice that a single system ALWAYS uses the **System A** output relay
 - When using external power relay, please refer to the connection diagrams.
2. Connect the power supply to the DEVlreg™ 850
 - Do not connect the power supply to mains yet
3. Connect sensors to the DEVlbus™
 - When used as a dual system, only the sensors for **System A** can be connected.
For connection of **System B** please refer to chapter: "Installation of dual system".
4. Connect the power supply to mains.

Fig. A — Connection of DEVIreg™ 850 IV

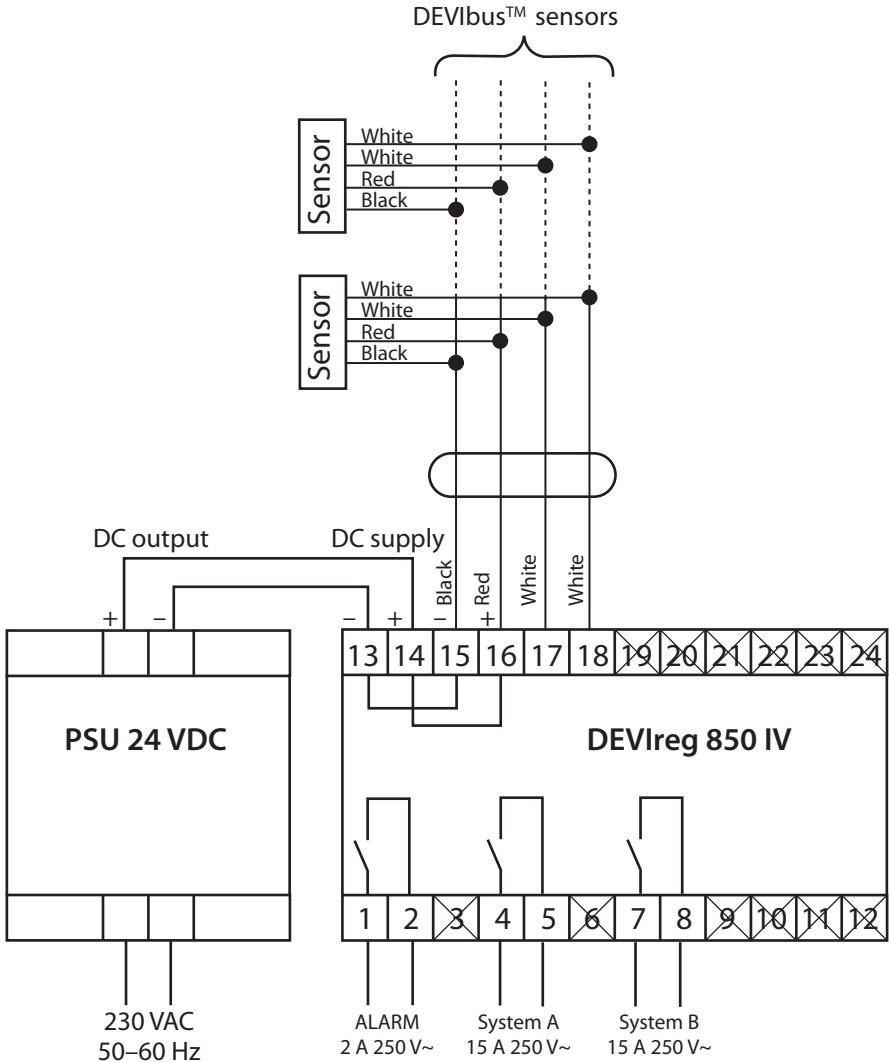

The DEVIreg™ 850 has an integral alarm function that monitors the attached sensors and the in-built microprocessor. An external alarm may also be connected to the system.

Fig. B

230 V cables, 1–3 P/1–3 loads — **System A**

Fig. C

230 V cables, 1–3 P/1–3 loads — **System B**

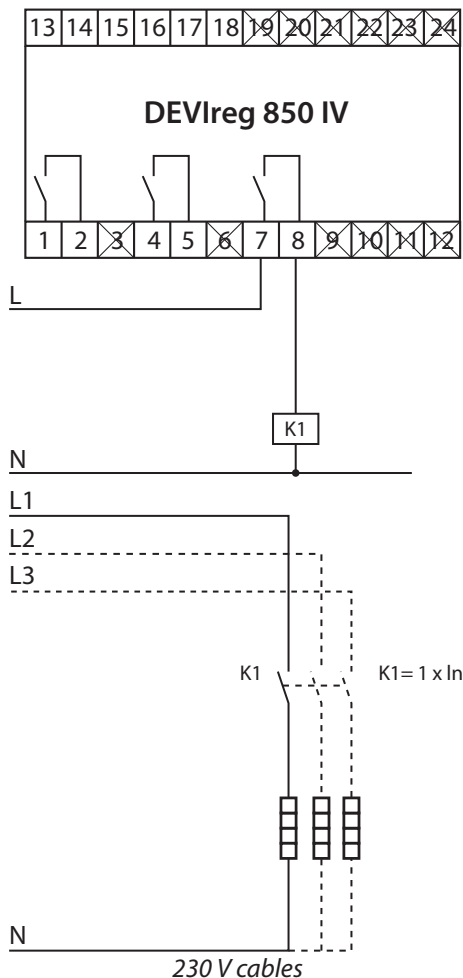
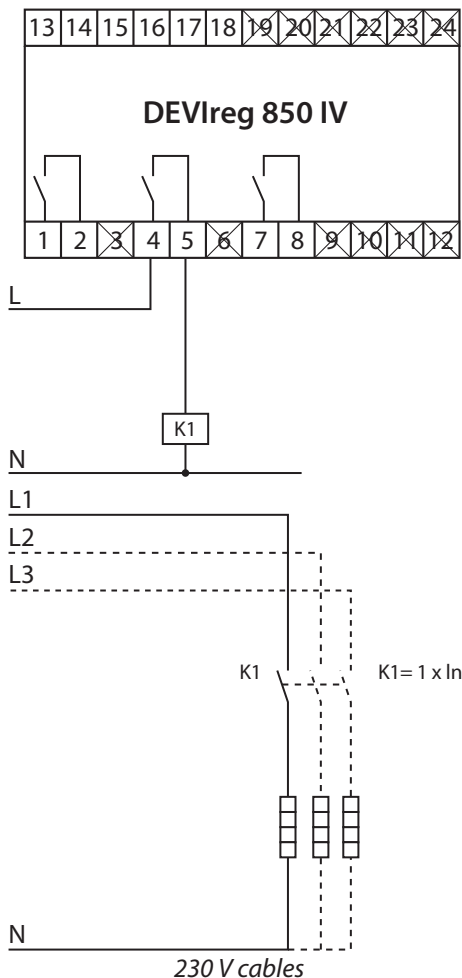

Fig. D

400 V cables, 2–3 Phase/1–3 Loads — **System A**

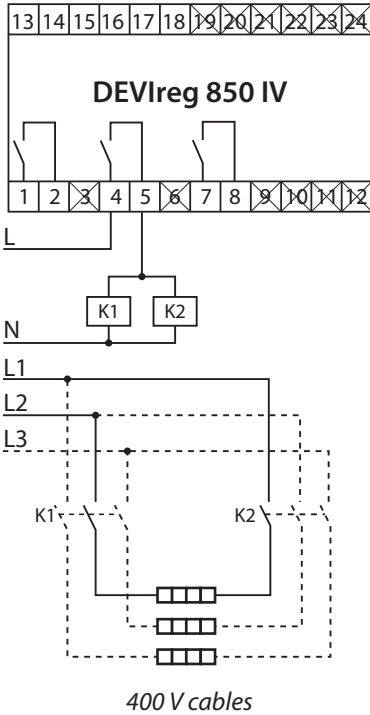

Fig. E

400 V cables, 2–3 Phase/1–3 Loads — **System B**

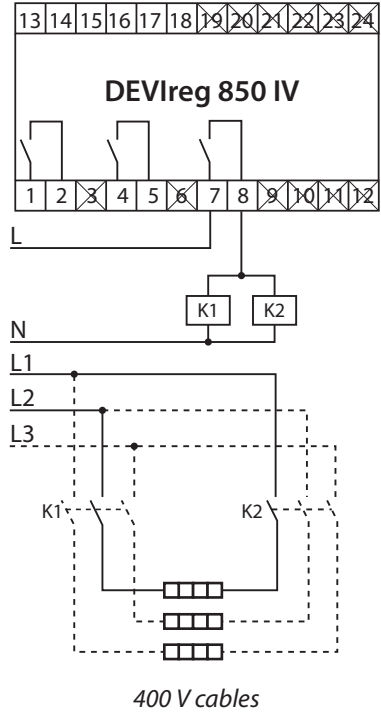

Fig. F

Direct connection — **System A**

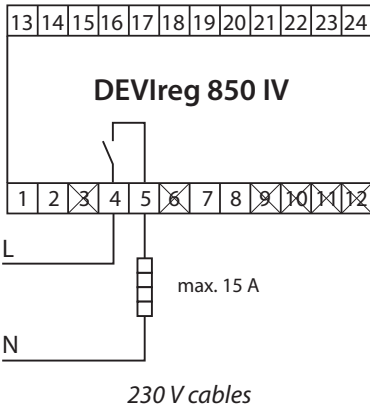
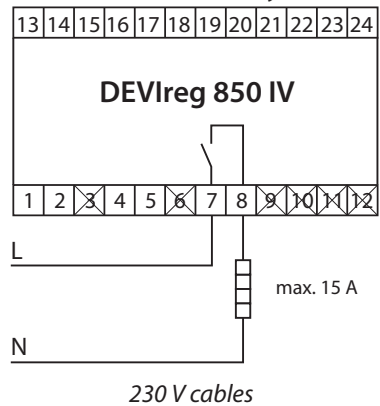

Fig. G

Direct connection — **System B**



2.4 Installation steps for system/systems

The installation of the DEVireg™ 850 is very easy, and the user is guided through the installation process. The installation process differs a little depending on which kind and the number of systems to be installed.

Please follow the general description and finally select the installation scenario according to the system type.

Change setting with key:



Accept setting with key:



General

 Power on DEVireg™ 850 IV



WELCOME TO
DEVIREG 850 IV

 Select language



SELECT LANGUAGE:
ENGLISH

System is being checked...

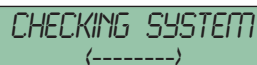

CHECKING SYSTEM
⟨-----⟩

 Select system configuration

- **Roof system** (1 system)
- **Ground system** (1 system)
- **Combi system** (2 systems)
- **Dual system** (2 systems)

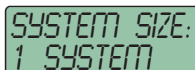

SYSTEM SIZE:
1 SYSTEM

The rest of the installation is divided into the system configurations; roof, ground, combi or dual, as listed above.

Installation of roof system

The installation of a DEVireg™ 850 with **1 roof** system has been selected.

It is optional if the sensors are connected to the DEVireg™ 850 before power on or during the installation.

 The system uses the output **System A**.



If sensors for **System A** are not connected — do it now!

 Press  or wait...



System is being scanned to find type of connected sensors...

 Select system type: Roof

 Wait until correct number of sensors for **System A** is found.



 Press  when all sensors are found...
System A is installed...

System is being checked...

 Press  to configure **System A** (naming sensors and changing factory settings).

Please refer to “Changing parameters and performance of systems” in “User Manual” for description of the configurable parameters.

If for some reason you do not wish to configure the system now you can press  to skip configuration of system.

 Press  to end configuration.

CONNECT SENSORS:
SYSTEM A

SYSTEM A
SCANNING...

SYSTEM TYPE:
ROOF

1 ROOF SENSOR
FOUND. ACCEPT?

SYSTEM A!
INSTALLED

CHECKING SYSTEM
<----->

CONFIG SYSTEM:
SYSTEM A

PRESS  TO END
CONFIGURATION.

Installation of ground system

The installation of a DEVlreg™ 850 with **1 ground** system has been selected.

It is optional if the sensors are connected to the DEVlreg™ 850 before power on or during the installation.

 The system uses the output **System A**.

If sensors for **System A** are not connected — do it now!

 Press  or wait...

CONNECT SENSORS:
SYSTEM A

System is being scanned to find type of connected sensors...



SYSTEM A
SCANNING...

 Select system type: Ground.

SYSTEM TYPE:
GROUND

 Wait until correct number of sensors for **System A** is found.



3 GROUND SENSOR
FOUND. ACCEPT?

 Press  when all sensors are found...
System A is installed...

SYSTEM A!
INSTALLED

System is being checked...

CHECKING SYSTEM
<----->

 Press  to configure **System A** (naming sensors and changing factory settings).

CONFIG SYSTEM:
SYSTEM A

Please refer to “Changing parameters and performance of systems” in “User Manual” for description of the configurable parameters.

If for some reason you do not wish to configure the system now you can press  to skip configuration of system.

 Press  to end configuration.

PRESS  TO END
CONFIGURATION.

Installation of combi system

The installation of a DEVIreg™ 850 with **1 roof** and **1 ground** system has been selected.

It is optional if the sensors are connected to the DEVIreg™ 850 before power on or during the installation.

-  The first installed system (**System A**) is using the output **System A**.
The second installed system (**System B**) is using the output **System B**.

It is freely selectable if System A should be the roof or ground system. However it is preferable that System A is the roof system, since System A is shown on the upper line of the display. Please refer to the description of the Display and Combined view in the user manual.



If sensors for **System A** are not connected — do it now!

-  Press  or wait...

System is being scanned to find type of connected sensors...

-  Select system type: Roof (if roof system is preferred as **System A**)

-  Wait until correct number of sensors for **System A** is found.

-  Press  when all sensors are found...
System A is installed...

If sensors for **System B** are not connected — do it now!

-  Press  or wait...

System is being scanned to find type of connected sensors...

-  Wait until correct number of sensors for **System B** is found.

-  Press  when all sensors for **System B** are found...

CONNECT SENSORS:
SYSTEM A

SYSTEM A
SCANNING...

SYSTEM TYPE:
ROOF

1 ROOF SENSOR
FOUND. ACCEPT?

SYSTEM A!
INSTALLED

CONNECT SENSORS:
SYSTEM B

SYSTEM B
SCANNING...

SYSTEM TYPE:
GROUND

3 GROUND SENSORS
FOUND. ACCEPT?

Press  when all sensors for **System B** are found...
System B is installed...

SYSTEM B!
INSTALLED

System is being checked...

CHECKING SYSTEM
(-----)

Press  to select system to configure.

CONFIG SYSTEM:
SYSTEM A

Press  to configure selected system (naming sensors, changing factory settings and setting priorities.)

CONFIG SYSTEM:
SYSTEM B

Please refer to “Changing parameters and performance of systems” in “User Manual” for description of the configurable parameters.

Press  to end configuration.

PRESS  TO END
CONFIGURATION.

Installation of dual system

The installation of a DEVIreg™ 850 with **2 roof** systems or **2 ground** systems has been selected.

It is **mandatory** that no sensors or only sensors for **System A** are connected to the the DEVIreg™ 850 before power up. Sensors for **System B** must be connected to the DEVIreg™ 850 during the installation steps. Connection of the sensors during installation can either be done using a switch on the DIN-rail or just connect sensor bus of **System B** to the already connected sensor bus of **System A**.

-  The first installed system (**System A**) is using the output **System A**.
The second installed system (**System B**) is using the output **System B**.

If sensors for **System A** are not connected — do it now!

-  Press  or wait...

CONNECT SENSORS:
SYSTEM A

System is being scanned to find type of connected sensors...



SYSTEM A
SCANNING...

-  Select system type: Ground.

SYSTEM TYPE:
GROUND

-  Wait until correct number of sensors for **System A** is found.

1 GROUND SENSOR
FOUND. ACCEPT?

-  Press  when all sensors for **System A** are found...
System A is installed...

SYSTEM A!
INSTALLED

Connect sensors for **System B**.

-  Press  or wait...

CONNECT SENSORS:
SYSTEM B

System is being scanned to find type of connected sensors...

SYSTEM B
SCANNING...

-  Select system type.

SYSTEM TYPE:
GROUND

-  Wait until correct number of sensors for **System B** is found.

1 GROUND SENSOR
FOUND. ACCEPT?

Press  when all sensors for **System B** are found...

System B is installed...

System is being checked...



SYSTEM B!
INSTALLED



CHECKING SYSTEM
<----->

Press  to select system to configure.

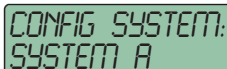

CONFIG SYSTEM:
SYSTEM A

Press  to configure selected system (naming sensors, changing factory settings and setting priorities.)

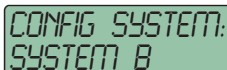

CONFIG SYSTEM:
SYSTEM B

Please refer to “Changing parameters and performance of systems” in “User Manual” for description of the configurable parameters.

Press  to end configuration.



PRESS □ TO END
CONFIGURATION.

2.5 Modification of system(s)

It is possible to modify the installed systems on the DEVireg™ 850. The following modifications are possible:

- **Reactivate passive sensors**
- **Replace a malfunctioning sensor**
- **Add an extra sensor**

When the DEVireg™ 850 cannot communicate with a sensor, the DEVireg™ 850 reports the error: "Errors detected!". The DEVireg™ 850 does not rely on malfunctioning sensors, and therefore the DEVireg™ 850 makes the sensor passive. The passive sensor is no longer used for ice and snow detection — not even after a power cycle.

 If the malfunctioning is caused by problems with the wiring, the failure can be fixed, and the sensor can be reactivated.

 If the malfunctioning is caused by an error prone sensor, the error can be corrected by replacing the error prone sensor with a new sensor.

 It is not possible to delete a passive sensor in a system. Passive sensors will remain in the systems until they are replaced with new sensors. The only way to delete a passive sensor (other than replacing it), is to make a **Master Reset** and reinstall the DEVireg™ 850 (please refer to chapter: General use).

Reactivate passive sensors:

The given example is for a ground system.

 From the **installer menu** select **Change system**.

Press  to activate **Change system**.

The system is searching for connected sensors.

If any passive sensors are found, they are reactivated.
Message is shown for 3 seconds.

If no new sensors are found, it is reported to the user.
Message is shown for 3 seconds.



CHANGE SYSTEM

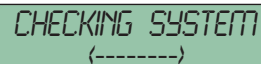

CHECKING SYSTEM
<----->

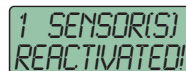

1 SENSOR(S)
REACTIVATED!



NO GROUND
SENSORS FOUND!



Replacing a malfunctioning sensor

 From the **installer** menu select **Change system**. The system is searching for connected sensors.



CHECKING SYSTEM
(-----)

The user selects the passive sensor, which should be replaced with a new one.

REPLACE SENSOR:
SENSOR1 03FB2F

 Press  to loop through the found passive sensors or to cancel replace sensor.



REPLACE SENSOR:
SENSOR2 03FC24

 Press  when the correct passive sensor or “Cancel replace sensor?” is selected.



CANCEL REPLACE
SENSOR?

If the user selected a passive sensor to replace, the user should now select the new sensor.

ADD SENSOR:
ID: 03ABC1

 Press  to loop through the found new sensors or to cancel replace sensor.

ADD SENSOR:
ID: 03DEF1

 Press  when the correct new sensor to add is found or “Cancel replace sensor?” is selected.

CANCEL REPLACE
SENSOR?



If the user selected a new sensor to add, the replacing of the sensors is performed.

SENSOR REPLACED!



Add an extra sensor

 From the **installer** menu select **Change system**. The system is searching for connected sensors.

CHECKING SYSTEM
(-----)

 Press  to loop through the found passive sensors or to cancel replace sensor.

ADD SENSOR:
ID: 03ABC1

 Press  when the correct new sensor to add is found or “Cancel add sensor?” is selected.

CANCEL ADD
SENSOR?

If the user selected a new sensor to add, the sensor is added.

SENSOR ADDED!

3 Technical Specifications

3.1 Technical data

Voltage: • DEVireg™ 850 IV • PSU 24 VDC	24 VDC ±10% 100 – 240 VAC, 50–60 Hz / 24 VDC, 2,5 A
Power consumption: • DEVireg™ 850 IV • Roof sensor • Ground sensor	Max. 3 W Max. 8 W (each)* Max. 13 W (each)*
Relay resistive load, max.: • Alarm relay • System A relay • System B relay Inductive load each relay, max.:	2 A 230 V~ 15 A 230 V~ 15 A 230 V~ 1 A 230 V~ (power factor 0,3)
IP class: • DEVireg™ 850 IV • Roof sensor • Ground sensor	IP 20 IP 67* IP 67*
Ambient temperature: • DEVireg™ 850 IV • Roof sensor(s) • Ground sensor(s)	–10 °C to +40 °C –50 °C to +70 °C* –30 °C to +70 °C*
Sensor type:	DEVibus™ connected moisture sensor(s)
Indication:	2 × 16-character illuminated display Alarm light (red) Lit info key (yellow)
Measurements (D x H x W): • DEVireg™ 850 IV • Roof sensor • Ground sensor • Tube ground sensor	53 × 86 × 105 mm 15 × 23,5 × 216 mm* ø = 87 mm; height = 74 mm* ø = 93 mm; height = 98 mm*
Versions (languages):	Latin: GB, CZ, DE, DK, ES, EST, FI, FR, HR, HU, LT, LV, NL, NO, PL, SCG, SE, SI, SK, TR. Cyrillic: GB, BG, RO, RU.
Cable specification for terminals, max	1 × 4 mm ² or 2 × 2,5 mm ²
Protection class:	Class II
Ball pressure test temperature:	75 °C
Pollution degree:	2 (domestic use)
Controller type:	1C
Software class:	A
Storage temperature:	–20 °C to +65 °C
Mounting method:	DIN rail

* For further information on the sensors please refer to the sensor manual.

3.2 Factory settings

Roof System

Function	Factory settings	Range/Options
Moisture level	50	5 to 95 (5 being the most sensitive to moisture)
Melting temperature	1.5 °C	0.0 °C to 9.9 °C
Post-heat	1 hour	0 to 9 hours
Clogged drain	On	On/off
System mode	Automatic	<ul style="list-style-type: none"> • Automatic • Constant ON (manual timer) • Manually OFF

Ground system

Function	Factory settings	Range/Options
Moisture level	50	5 to 95 (5 being the most sensitive to moisture)
Standby temperature	-3.0 °C	-20 °C to 0 °C
Melting temperature	4.0 °C	1.0 °C to 9.9 °C
Post-heat	1 hour	0 to 9 hours
Clogged drain	On	On/off
System mode	Automatic	<ul style="list-style-type: none"> • Automatic • Constant ON (manual timer) • Manually OFF

4 Appendix

A: Menu system

Main menu

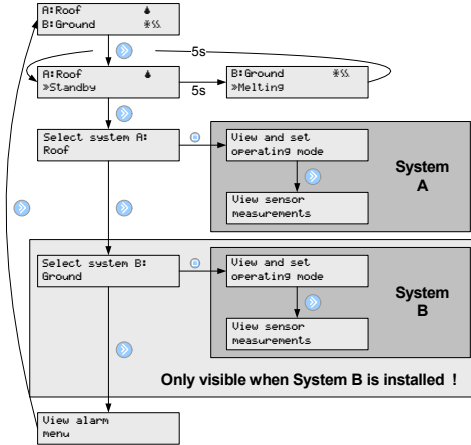

System menu

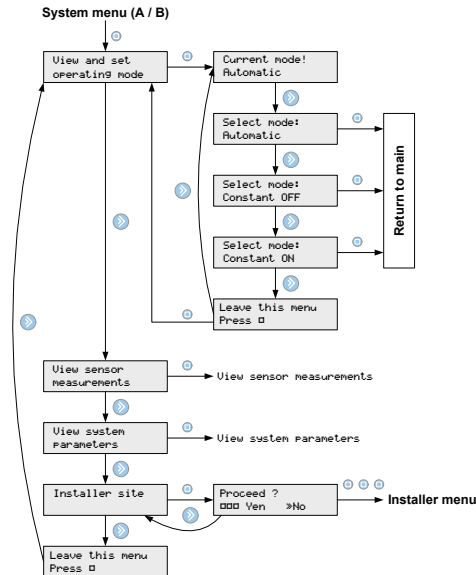

View sensor measurements

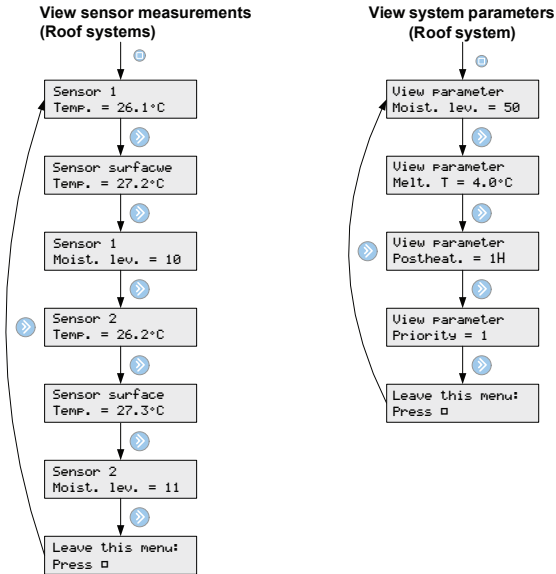

View sensor parameters

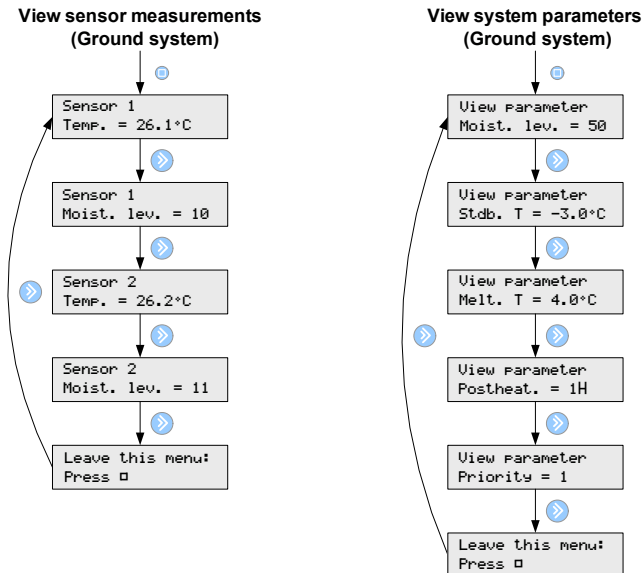

Installer menu

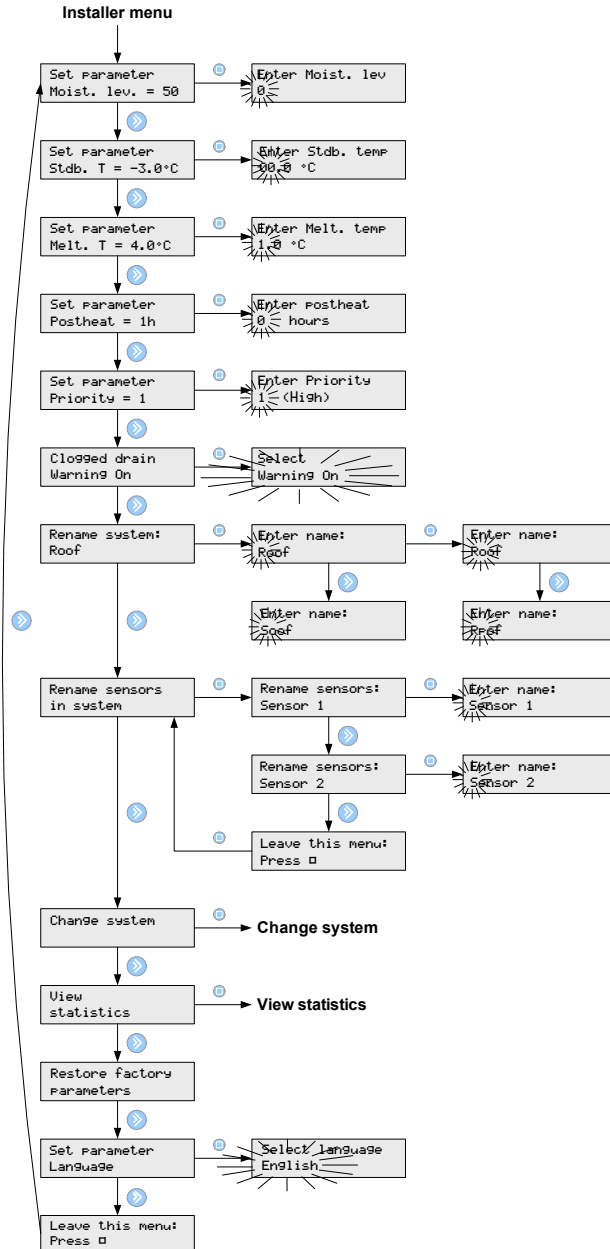

Change system

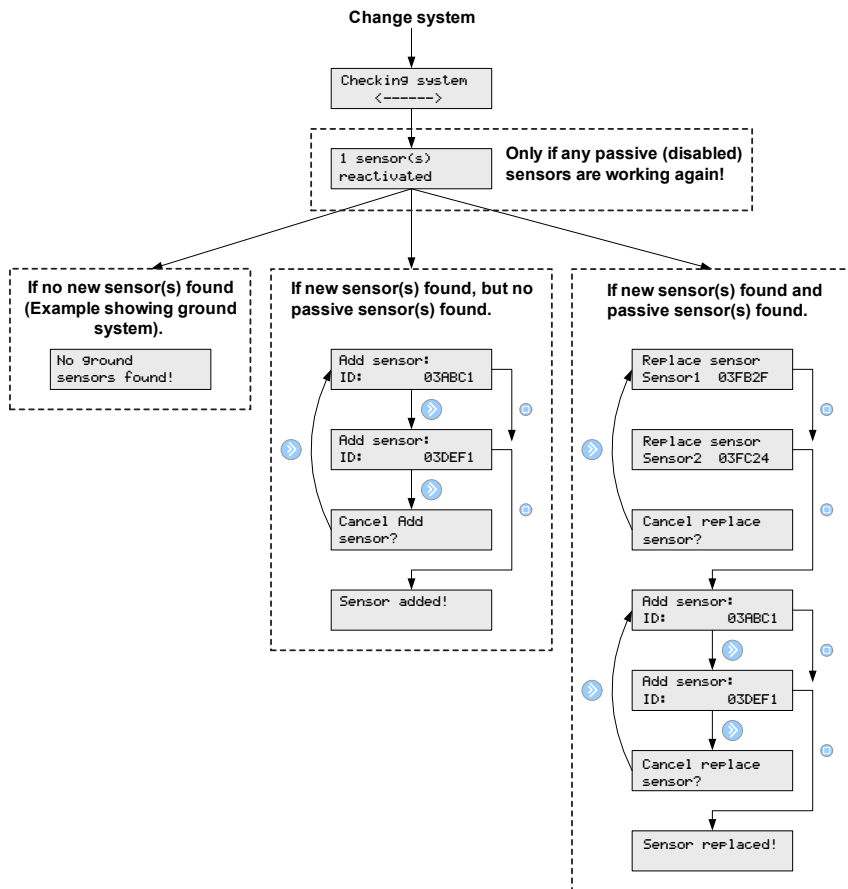

View statistic

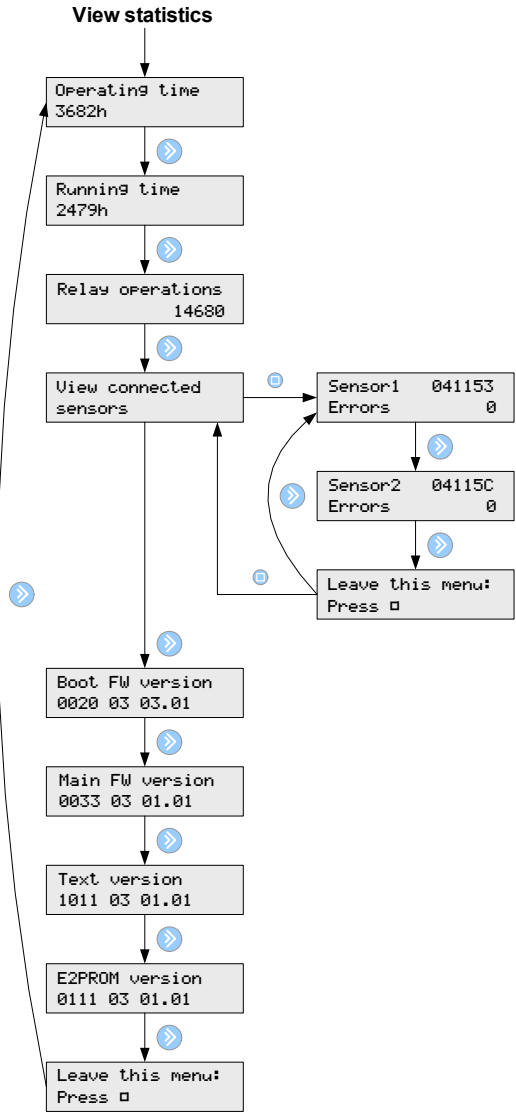

B: How it works

Roof system

The roof system is fully automated. It gathers information on moisture and temperature via digital sensors continuously. The sensors are placed on strategic spots in gutters or down pipes (for further information on the sensor please refer to the sensor manual).

By combining measurements of both moisture and temperature a reliable detection of the situation is achieved. Hence it is known whether heating of the roof area is needed in order to avoid that the roof is covered by ice and snow.

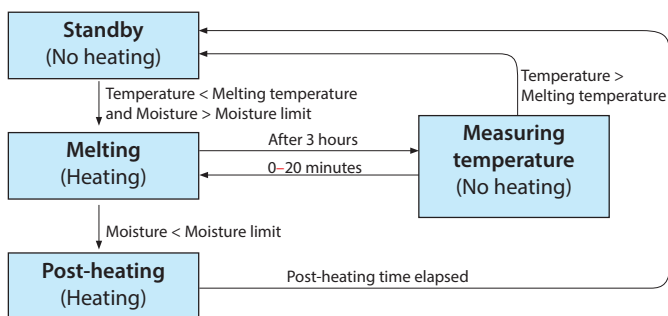

Standby

The system is on standby and awaits heating of the roof area. Heating of the roof area will start when the following conditions are fulfilled:

- Measured moisture is higher than the chosen limit for moisture.
- Measured temperature is lower than the chosen melting temperature

Temperature and moisture are measured continuously by the sensors.

Melting ice and snow

The roof area is heated in periods of 3 hours. Within that period a decrease in moisture will stop the heating and activate post-heating. The post-heating function can be disabled.

Measuring temperature

The heating function is suspended every third hour meaning that the heating cables are turned off. This is done in order to allow the sensors to measure the temperature, without being influenced by the heated cables. The temperature measurement may last up to 20 minutes. If the measured temperature is higher than the chosen melting temperature the heating period is ended; if not, heating of the roof area is resumed after the temperature measurement.

Post-heating

If the reason for ending a heating period is a decrease of moisture to below the chosen level the post-heating period will start. Post-heating ensures that no ice and snow is left on the roof.

Ground system

The ground system is fully automated. It gathers information on moisture and temperature via digital sensors continuously. The sensors are placed on strategic spots on the ground area (for further information on the sensor please refer to the sensor manual). By combining measurements of both moisture and temperature a reliable detection of the situation is achieved.

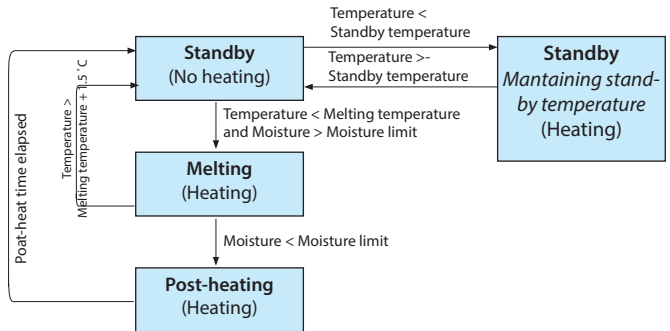

Hence it is known whether heating of the ground area is needed in order to avoid that the ground area is covered by ice and snow.

Standby

The system is on standby awaiting need for heating. If the measured temperature is below the chosen standby temperature the system will automatically heat the area in order to maintain the standby temperature.

Melting (heating) will start when the two following conditions are fulfilled:

- Measured moisture is higher than the chosen limit for moisture.
- Measured temperature is lower than the chosen melting temperature

Temperature and moisture are measured continuously by the sensors.

Melting Ice and snow

As long as the measured temperature is lower than the chosen melting temperature heating of the ground area will be on. When the measured temperature reaches the chosen melting temperature and the measured moisture level is below the chosen limit, the post-heating function will be activated. The post-heating function can be disabled.

If moisture is detected on the ground area the system will continue to heat the area in order to maintain the melting temperature. It is, however, important to understand that even when the system is melting ice and snow it is not necessarily heating at all times. The heating will be turned on and off in accordance with the measured temperature in order to maintain a constant melting temperature.

If the temperature rises more than 1.5 °C above the chosen melting temperature the system will automatically stop heating the area irrespective of the moisture on the area.

Post-heating

If the reason for ending a heating period is a decrease of moisture to below the chosen level, the post-heating period will start. Post-heating ensures that no ice and snow is left on the roof.



If system priority is low, heating might be paused at any time!



The ground system uses heated sensors which under normal circumstances will hold a temperature of 1.5 °C. In connection with measuring the area temperature heating of the sensor is turned off for 90 minutes at a time. This is done in order to obtain a correct measurement of area temperature which is not influenced by sensor temperature. If a system only has one sensor this sensor is constantly heated for 90 minutes and then turned off for 90 minutes. This entails that measurement of temperature can be up to 3 hours delayed. With more than one sensor this performance is significantly improved.

Security and energy consumption

High security — higher energy consumption

If a high degree of security against ice and snow is wanted, make the following adjustments of the operation parameters:

- Increase the standby temperature
- Increase the melting temperature
- Decrease the moisture level (close to setting 5)
- Prolong the post-heat period

This will give a high degree of security in even dry areas.

Low security — lower energy consumption

Conversely, low energy consumption and a moderate level of security against ice and snow could be prioritized. In this case make the following adjustments of the operation parameters:

- Decrease the standby temperature
- Decrease the melting temperature
- Increase the moisture level
- Shorten the post-heat period

This will give relatively low energy consumption, but the area may remain wet and icy in short periods.

 The factory settings are average values providing a relatively high degree of security and moderate energy consumption.

C: PSU and feeder cable

Note: max. 3 m length of the cable between the PSU and the 850 controller.

PSU. If power supply unit (PSU) is 60W/2,5A follow the rules below.

Ground system

	1 pcs. PSU 24 VDC 60 W	1 pcs. PSU 24 VDC, 60 W	
Number of sensors:	1 or 2	3	4
Cable type	Max. length (m)	Max. length (m)	Max length (m)
1 mm ²	300	150	80
1.5 mm ²	450	225	120
2.5 mm ²	750	360	200
4 mm ²	1200	600	310

Roof System

	1 pcs. PSU 24 VDC 60 W		1 pcs. PSU 24 VDC, 60 W	
Number of sensors:	1	2	3	4
Cable type	Max length (m)	Max length (m)	Max length (m)	Max length (m)
1 mm ²	400	100	130	75
1.5 mm ²	600	150	200	110
2.5 mm ²	1000	250	330	190
4 mm ²	1600	400	525	300

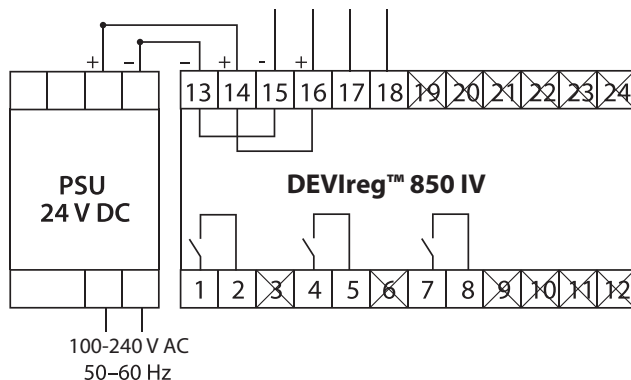

5 Warranty

A 2-year product warranty is valid for:

- thermostats: DEVireg™ 850 IV.

Should you, against all expectations, experience a problem with your DEVI product, you will find that Danfoss offers DEVIwarranty valid from the **date of purchase** on the following conditions: During the warranty period Danfoss shall offer a new comparable product or repair the product if the product is found to be faulty by reason of defective design, materials or workmanship. The repair or replacement.

The decision to either repair or replace will be solely at the discretion of Danfoss. Danfoss shall not be liable for any consequential or incidental damages including, but not limited to, damages to property or extra utility expenses. No extension of the warranty period following repairs undertaken is granted.

The warranty shall be valid only if the WARRANTY CERTIFICATE is completed correctly and in accordance with the instructions, the fault is submitted to the installer or the seller without undue delay and proof of purchase is

provided. Please note that the WARRANTY CERTIFICATE must be filled in, stamped and signed by the authorized installer performing the installation (Installation date must be indicated). After the installation is performed, store and keep the WARRANTY CERTIFICATE and purchase documents (invoice, receipt or similar) during the whole warranty period.

DEVIwarranty shall not cover any damage caused by incorrect conditions of use, incorrect installation or if installation has been carried out by non-authorized electricians. All work will be invoiced in full if Danfoss is required to inspect or repair faults that have arisen as a result of any of the above. The DEVIwarranty shall not extend to products which have not been paid in full. Danfoss will, at all times, provide a rapid and effective response to all complaints and inquiries from our customers.

The warranty explicitly excludes all claims exceeding the above conditions.

For full warranty text visit www.devi.com.
devi.danfoss.com/en/warranty/

WARRANTY CERTIFICATE

The DEVIwarranty is granted to:

Address _____ Stamp _____

Purchase date _____

Serial number of the product _____

Product _____ Art. No. _____

*Connected output [W] _____

Installation Date _____ Connection Date _____
& Signature _____ & Signature _____

**Not mandatory*



8097071

Danfoss A/S

Nordborgvej 81
6430 Nordborg, Syddanmark
Denmark

Danfoss Randall Ltd.
Amphill Road
Bedford
MK42 9ER

Danfoss A/S

DEVI • devl.com • +45 7488 2222 • EH@danfoss.com

Any information, including, but not limited to information on selection of product, its application or use, product design, weight, dimensions, capacity or any other technical data in product manuals, catalogues descriptions, advertisements, etc. and whether made available in writing, orally, electronically, online or via download, shall be considered informative, and is only binding if and to the extent, explicit reference is made in a quotation or order confirmation. Danfoss cannot accept any responsibility for possible errors in catalogues, brochures, videos and other material. Danfoss reserves the right to alter its products without notice. This also applies to products ordered but not delivered provided that such alterations can be made without changes to form, fit or function of the product.

All trademarks in this material are property of Danfoss A/S or Danfoss group companies. Danfoss and the Danfoss logo are trademarks of Danfoss A/S. All rights reserved.