

ENGINEERING
TOMORROW

Danfoss

APAC

Winner[®] by Danfoss
hose and fittings



Winner by Danfoss

Table of contents

Important safety and ordering information	3
Winner hose fittings	4
Danfoss Intelligent Layline	5

Winner hoses 7

Winner braided hoses	8
Winner spiral hoses	11
Winner textile hoses	13
Winner thermoplastic hoses	15

Two-piece fittings 18

DIN 24° DKO Light (DKO-L)	20
DIN 24° DKO Heavy (DKO-S)	24
Code 61	28
JIC	31
ORS	36
BSP	40
NPTF	44
Staple-Lock	46

1T/4S/6S fitting series 47

DIN 24° DKO Light (DKO-L)	47
DIN 24° DKO Heavy (DKO-S)	48
Code 61 Flange	50
Code 62 Flange	53
CAT® Flange	56
JIC	59
ORS	62
BSP 60° Cone	65

Important safety and ordering information

WARNING

Danfoss fitting tolerances are engineered to match approved Danfoss hose tolerances. The use of Danfoss fittings on hose supplied by other manufacturers and/or the use of Danfoss hoses with fittings supplied by other manufactures may result in the production of unreliable and unsafe hose assemblies and is neither recommended nor authorized by Danfoss or any of its affiliates or subsidiaries.

WARNING

Application considerations must be observed in selecting appropriate components for the application of these products contained herein. The failure to follow the recommendations set forth in this catalog may result in an unstable application which may result in serious personal injury or property damage.

DANFOSS OR ANY OF ITS AFFILIATES OR SUBSIDIARIES SHALL NOT BE SUBJECT TO AND DISCLAIMS ANY OBLIGATIONS OR LIABILITIES (INCLUDING BUT NOT LIMITED TO ALL CONSEQUENTIAL, INCIDENTAL AND CONTINGENT DAMAGES) ARISING FROM TORT CLAIMS (INCLUDING WITHOUT LIMITATION NEGLIGENCE AND STRICT LIABILITY) OR OTHER THEORIES OF LAW WITH RESPECT TO ANY HOSE ASSEMBLIES NOT PRODUCED FROM GENUINE DANFOSS HOSE FITTINGS, HOSE AND DANFOSS APPROVED EQUIPMENT, AND IN CONFORMANCE WITH DANFOSS' SYNDFLEX PROCESS AND PRODUCT INSTRUCTIONS FOR EACH SPECIFIC HOSE ASSEMBLY.

Failure to follow these processes and product instructions and limitations could lead to premature hose assembly failures resulting in property damage, serious injury or death.

Warranty

Current warranty information can be found at:
www.Danfoss.com

Hose Fitting Part Number Nomenclature

- 26711 D-04-04 SM W Z**
- Fitting Series** _____
 - Material Stock Code** _____
A = Large hex stock
D = Hex stock female nipple
If material is round stock position collapses
 - Terminal End Size** _____
 - Hose Size** _____
 - Special Suffix Code** _____
SM = Backup hex smaller than swivel hex
SP = BSPT with 60° cone
HXX = Special drop length, XX is the drop length in mm
If no special design is required, position collapses
 - Nut Design** _____
T = Captive nut
W = Wire nut
If crimp nut is used or if nut is not required, position collapses
 - Plating Type Code** _____
Z = Zinc Trivalent Chromate (Cr3)
ZD = Dura-Kote

Hose Installation

Proper installation of the hose is essential to the proper operation and safe use of the hose and related equipment. Improper installation of the hose can result in serious injury or property damage caused by spraying fluids or flying projectiles. In order to avoid serious bodily injury or property damage resulting from improper installation of the hose, you should carefully review the information in this catalog regarding hose installation. Some of the factors you must consider in installing the hose properly are:

- Changes in length
- Proper bend radius
- Protection from high temperature sources
- Elbows and adapters to relieve strain
- Rubbing or abrasion
- Twisting
- Improper hose movement

These factors and the other information in this catalog regarding hose installation should be considered by you before installing the hose. If you have any questions regarding proper hose installation, please contact Danfoss Technical Support.

Hose Maintenance

Proper maintenance of the hose is essential to the safe use of the hose and related equipment. Hose should be stored in a dry place. Hose should also be visually inspected. Any hose that has a cut or gouge in the cover that exposes the reinforcement should be retired from service. Hoses should also be inspected for kinking or broken reinforcement. If the outside diameter of the hose is reduced by 20% at the spot where it is bent then the hose should be retired from service. Inadequate attention to maintenance of the hose can result in hose leakage, bursting, or other failure which can cause serious bodily injury or property damage from spraying fluids, flying projectiles, or other substances.

Winner hose fittings

Braided Hose Fittings

Spiral Hose Fittings

Premium 1A(TTC)-Series



Features:

- New **DURA-KOTE™** plating technology for up to 1,000 hours of corrosion resistance
- Bite the wire technology for best in class connection and sealing
- Class zero leakage SAE J1176 on approved hose styles
- Over 550 1A(TTC)-Series part numbers available
- Danfoss's **MatchMate™** program provides identification markings on the hose, hose fittings, and crimp dies for quick and easy assembly

Refer to master catalog for more information.

Standard Two-piece Winner



Features:

- Non-skive, two-piece crimp fitting
- One nipple part number for EC115, EC215, EC110, EC210, EC118, EC082, WH004, WH005, WH006, WH007 standard hoses
- Meets industry specifications when used with the EC115, EC215, EC110, EC210, EC118, EC082, WH004, WH005, WH006, WH007 standard hoses
- Clear silver hexavalent chromium-free plating
- Carbon steel material

Premium 4S/6S Spiral Series



Features:

- New **DURA-KOTE™** plating technology for up to 1,000 hours of corrosion resistance
- New patent pending **DURA-SEAL™** technology to eliminate hose assembly cool-down leakage
- Class zero leakage SAE J1176 on approved hose styles
- Danfoss's **MatchMate™** spiral-hose/fitting identification system program provides identification markings on the hose, hose fittings, and crimp dies for quick and easy assembly
- Refer to master catalog for more information.

DURA-KOTE™ Plating Technology

Hose fittings that will now offer 3x the corrosion protection on carbon steel fittings as compared to competitive hose fittings. Danfoss's DURA-KOTE fittings provide up to 1000 hours of corrosion protection. This is a huge step forward in metal fitting corrosion protection. (Only on 4S/6S fittings)

3X Carbon Steel Corrosion Protection



DURA-SEAL™ Technology

This patent-pending innovation from Danfoss eliminates hose assembly cool-down leakage, while extending hose assembly life, reducing equipment down-time. (Only on 4S/6S fittings)

Class 0 Cool-Down Leakage Protection



Danfoss **Intelligent** Layline

Our laylines provide
vital hose data
instantly.

Engineering is complex. We just made it easier.
Critical data at a glance.

When it comes to building the platforms and systems that drive the machines of the future, complex engineering makes it all possible. In hydraulics, specific hose capabilities and certifications must be tailored to the unique requirements of each application to optimize performance, maximize uptime and protect user safety. Danfoss' new laylines distill this complex engineering down into its essential parts for easy identification and simple assembly. Every key piece of information is located in one place, ensuring the right hose—with the right capabilities for the job—is easy to identify every time.

Enhanced readability: Danfoss' new laylines take the guesswork out of system assembly. Each layline is easy to read, including important information about the hose—such as the brand, part number, size, abrasion resistance, key specifications, pressure, temp and qualified fitting series.



Winner by Danfoss

EC420-16

25.4 MM (1.00 IN)
DN25

SAE 1
MSHA



9.5 mm (0.38 in)
DN10

EC215-06

Winner by Danfoss

EN857 25C • ISO 18752
MSHA C-84/41 • DNV-GL • USE

BRAND	PART #	SIZE (I.D.)	AGENCY SPECIFICATIONS	PRESSURE	TEMP	SAE BEND	FITTING
Winner by Danfoss	EC215-06	9.5 mm (0.38 in) DN10	EN857 25C - ISO 18752 MSHA IC-84/41 - DNV - USCG +	345 BAR (5000 PSI)	-40°C to +100°C -40°F to +212°F	HALF BEND	1A 2PC

Agency specifications

Hose agency specifications are clearly defined on each hose. SAE, ISO, MSHA, DNV, USCG designation are displayed clearly on each hose, taking the guess work out of hose qualifications.

In addition, many of Danfoss' premium hydraulic hoses exceed SAE and EN specifications to offer superior performance. We will now consistently note this and other specification-related terms on the layline.

Global comprehension

The new layline design also introduces easy-to-identify icons and pictograms, which allow more users around the world to intuitively identify performance characteristics associated with each of Danfoss' rubber hydraulic hoses. Icons include temperature, bend radius, pressure, correct fitting type and more.

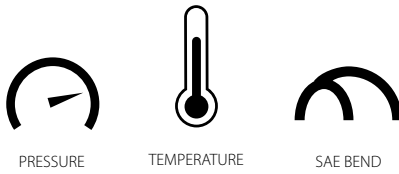

EN standards

Each hose standard specifies the minimum bend radius of a hose. This is defined as the smallest diameter the hose can be bent without kinking. However, Danfoss recognizes that merely meeting a standard is often not good enough for the tight routing needs of your applications. Many of our core hoses have long been engineered to perform at half or even one-third of the bend radius required by different standards.

For the first time, our laylines will now indicate when a hose exceeds the standard bend radius requirement. This improvement in bend means easier routing, better performance and reduced hose length requirements.

Fitting info

As part of this layline refresh, all of Danfoss' rubber hydraulic hoses will now utilize the simple, intuitive MatchMate hose & fitting system.

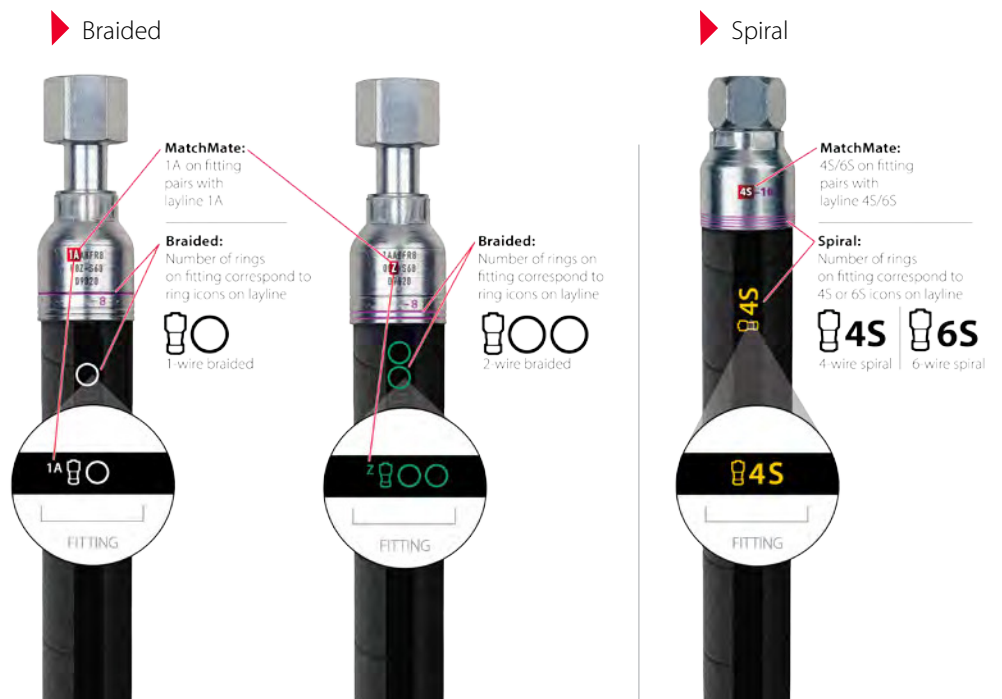

Winner hoses

The choice when **every job** matters.

Reliability and performance are essential, every day, for every project. Winner™ by Danfoss hose is the go-to everyday hose when every job matters. Designed specifically for less extreme applications that still need critical hose certifications, Winner hose fills the gap for more moderate applications.



Winner braided hoses

EC110 Hydraulic hose

Meets: SAE 100R1 • EN 853 1SN

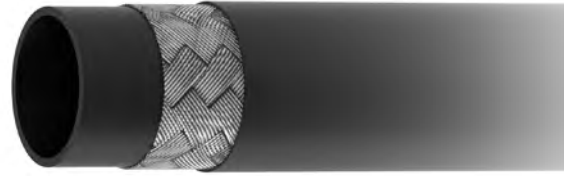

Layline example:

Winner by Danfoss **EC110-04** 6.4 MM (0.25 IN) DN6 | SAE 100R1 • EN 853 1SN MSHA IC-84/41 • DNV | ↻ 225 BAR (3250 PSI) | -40°C to +100°C (-40°F to +212°F) 1A 2pc

Construction: Inner Tube: Synthetic rubber Reinforcement: One steel braid Cover: Synthetic rubber

PART #	SIZE DIMENSIONS				PRESSURE				BEND		WEIGHT	
	Hose I.D.		Hose O.D. (nominal)		Working Pressure		Min. Burst Pressure		Min. Bend Radius		Weight	
	mm	in	mm	in	bar	psi	bar	psi	mm	in	kg/m	lbs/ft
EC110-04L	6.4	0.25	14.1	0.56	225	3,250	900	13,000	100	3.94	0.22	0.15
EC110-05L	7.9	0.31	15.7	0.62	215	3,125	860	12,500	115	4.53	0.26	0.17
EC110-06L	9.5	0.38	18.1	0.71	180	2,600	720	10,400	130	5.12	0.33	0.22
EC110-08L	12.7	0.50	21.4	0.84	160	2,300	640	9,200	180	7.09	0.41	0.28
EC110-10L	15.9	0.62	24.5	0.96	130	1,900	520	7,600	200	7.87	0.47	0.32
EC110-12L	19.0	0.75	28.5	1.12	105	1,525	420	6,100	240	9.45	0.59	0.40
EC110-16L	25.4	1.00	36.6	1.44	88	1,275	352	5,100	300	11.81	0.87	0.58
EC110-20L	31.8	1.25	44.8	1.76	63	925	252	3,700	420	16.54	1.20	0.81
EC110-24L	38.1	1.50	52.1	2.05	50	725	200	2,900	500	19.69	1.40	0.94
EC110-32L	50.8	2.00	65.5	2.58	40	580	160	2,320	630	24.80	1.91	1.28
EC110-40L*	63.5	2.50	78.0	3.07	40	580	200	2,900	762	30.00	2.52	1.69
EC110-48L*	76.2	3.00	90.5	3.56	35	508	160	2,320	900	35.43	2.70	1.81

* Only bulk hose

Operating Temperature: -40°C to +100°C (-40°F to +212°F)

Fittings: 1A-Series, Two-piece Winner

Typical Application:

Hydraulic system service with petroleum and water based fluids, for general industrial service.

Agency Specifications:

MSHA
DNV

EC115 Hydraulic hose

Meets: EN857 1SC



Layline Example:

Winner by Danfoss **EC115-08** 12.7 MM (0.50 IN) DN12 | EN857 1SC • MSHA IC-84/41 DNV • USCG ⚡ | ↻ 160 BAR (2300 PSI) | -40°C to +100°C (-40°F to +212°F) 1A 2PC

Construction: Inner Tube: Synthetic rubber Reinforcement: 1 steel braid Cover: Synthetic rubber

PART #	SIZE DIMENSIONS				PRESSURE				BEND		WEIGHT	
	Hose I.D.		Hose O.D. (nominal)		Working Pressure		Min. Burst Pressure		Min. Bend Radius		Weight	
	mm	in	mm	in	bar	psi	bar	psi	mm	in	kg/m	lbs/ft
EC115-04L	6.4	0.25	12.6	0.50	225	3,250	900	13,000	50	1.97	0.18	0.12
EC115-06L	9.5	0.38	16.0	0.63	180	2,600	720	10,400	63	2.48	0.26	0.17
EC115-08L	12.7	0.50	19.4	0.77	160	2,300	640	9,200	90	3.54	0.34	0.23
EC115-10L	15.9	0.62	22.4	0.88	130	1,900	520	7,600	100	3.94	0.42	0.28
EC115-12L	19.0	0.75	26.0	1.02	105	1,525	420	6,100	120	4.72	0.50	0.34
EC115-16L	25.4	1.00	33.8	1.33	88	1,275	352	5,100	160	6.30	0.74	0.50
EC115-20L	31.8	1.25	41.2	1.62	63	925	252	3,700	210	8.27	0.99	0.67
EC115-24L	38.1	1.50	48.0	1.89	50	725	200	2,900	300	11.81	1.20	0.81
EC115-32L	50.8	2.00	61.0	2.41	40	580	160	2,320	400	15.75	1.50	1.01

Operating Temperature: -40°C to +100°C (-40°F to +212°F)

Fittings: 1A-Series | Two-piece Winner

Typical Application:

Hydraulic system service with petroleum and water based fluids, for general industrial service.

Agency Specifications:

MSHA
DNV
USCG

EC210 Hydraulic hose

Meets: SAE 100R2 • EN 853 2SN



Layline example:

Winner by Danfoss **EC210-16** 25.4 MM (1.00 IN) DN25 | SAE 100R2 • EN 853 2SN MSHA IC-84/41 • DNV | **165 BAR (2400 PSI)** | -40°C to +100°C (-40°F to +212°F) | 1A 2pc

Construction: Inner Tube: Synthetic rubber Reinforcement: Two steel braids Cover: Synthetic rubber

PART #	SIZE DIMENSIONS				PRESSURE				BEND		WEIGHT	
	Hose I.D.		Hose O.D. (nominal)		Working Pressure		Min. Burst Pressure		Min. Bend Radius		Weight	
	mm	in	mm	in	bar	psi	bar	psi	mm	in	kg/m	lbs/ft
EC210-04L	6.4	0.25	15.7	0.62	400	5,800	1,600	23,200	100	3.94	0.38	0.26
EC210-05L	7.9	0.31	17.3	0.68	350	5,100	1,400	20,400	115	4.53	0.43	0.29
EC210-06L	9.5	0.38	19.7	0.78	330	4,800	1,320	19,200	125	4.90	0.54	0.36
EC210-08L	12.7	0.50	23.0	0.91	275	4,000	1,100	16,000	180	7.09	0.64	0.43
EC210-10L	15.9	0.62	26.2	1.03	250	3,650	1,000	14,600	200	7.87	0.75	0.50
EC210-12L	19.0	0.75	30.1	1.19	215	3,125	860	12,500	240	9.45	0.93	0.62
EC210-16L	25.4	1.00	38.9	1.53	165	2,400	660	9,600	300	11.81	1.29	0.87
EC210-20L	31.8	1.25	49.5	1.95	125	1,800	500	7,200	420	16.54	1.89	1.27
EC210-24L	38.1	1.50	55.9	2.20	90	1,300	360	5,200	500	19.69	2.10	1.41
EC210-32L	50.8	2.00	68.6	2.70	80	1,150	320	4,600	630	24.80	2.76	1.85
EC210-40L*	63.5	2.50	81.0	3.19	69	1,000	300	4,350	760	29.92	3.80	2.55
EC210-48L*	76.2	3.00	93.0	3.66	50	725	240	3,500	900	35.43	4.03	2.71

*Only bulk hose

Operating Temperature: -40°C to +100°C (-40°F to +212°F)

Fittings: 1A-Series, Two-piece Winner

Typical Application:

Hydraulic system service with petroleum and water based fluids, for general industrial service.

Agency Specifications:

MSHA
DNV

EC215 Hydraulic hose

Meets: EN857 2SC • ISO 18752



Layline Example:

Winner by Danfoss **EC215-06** 9.5 mm (0.38 in) DN10 | EN857 2SC • ISO 18752 MSHA IC-84/41 • DNV • USCG + | **345 BAR (5000 PSI)** | -40°C to +100°C (-40°F to +212°F) | HALF BEND | 1A 2PC

Construction: Inner Tube: Synthetic rubber Reinforcement: 2 steel braid Cover: Synthetic rubber

PART #	SIZE DIMENSIONS				PRESSURE				BEND		WEIGHT	
	Hose I.D.		Hose O.D. (nominal)		Working Pressure		Min. Burst Pressure		Min. Bend Radius		Weight	
	mm	in	mm	in	bar	psi	bar	psi	mm	in	kg/m	lbs/ft
EC215-04L	6.4	0.25	13.5	0.53	400	5,800	1,600	23,200	50	1.97	0.28	0.19
EC215-06L	9.5	0.38	17.5	0.69	345	5,000	1,380	20,000	65	2.56	0.41	0.28
EC215-08L	12.7	0.50	20.8	0.82	275	4,000	1,100	16,000	90	3.54	0.57	0.38
EC215-10L	15.9	0.62	24.0	0.94	250	3,650	1,000	14,600	100	3.94	0.68	0.46
EC215-12L	19.0	0.75	27.9	1.10	215	3,125	860	12,500	120	4.72	0.81	0.54
EC215-16L	25.4	1.00	35.7	1.40	165	2,400	660	9,600	160	6.30	1.17	0.79
EC215-20L	31.8	1.25	43.9	1.73	125	1,800	500	7,200	250	9.84	1.56	1.05
EC215-24L	38.1	1.50	51.0	2.01	100	1,450	400	5,800	300	11.81	1.81	1.22
EC215-32L	50.8	2.00	63.4	2.50	90	1,300	360	5,200	400	15.75	2.36	1.59

Operating Temperature: -40°C to +100°C (-40°F to +212°F)

Fittings: 1A-Series | Two-piece Winner

Typical Application:

Hydraulic system service with petroleum and water based fluids, for general industrial service.

Agency Specifications:

MSHA
DNV
USCG

Winner braided hoses

EC118 Hydraulic hose

Meets: SAE 100R17 • ISO 18752

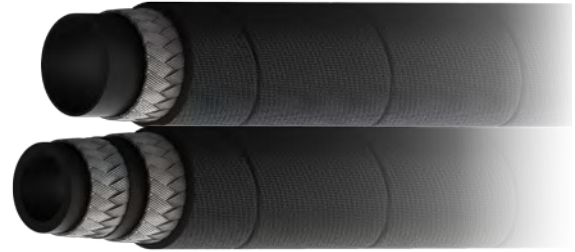

Layline Example:

Winner by Danfoss **EC118-08** 12.7 mm (0.50 in) DN12 | SAE 100R17 • ISO 18752 MSHA IC-84/41 • USCG | 210 BAR (3050 PSI) -40°C to +100°C (-40°F to +212°F) 1A 2PC

Construction: Inner Tube: Synthetic rubber **Reinforcement:** 1 wire braid: -04, -06, -08; 2 wire braid: -10, -12, -16 **Cover:** Synthetic rubber

PART #	SIZE DIMENSIONS				PRESSURE				BEND		WEIGHT	
	Hose I.D.		Hose O.D. (nominal)		Working Pressure		Min. Burst Pressure		Min. Bend Radius		Weight	
	mm	in	mm	in	bar	psi	bar	psi	mm	in	kg/m	lbs/ft
EC118-04L	6,4	0,25	12,2	0,48	210,0	3050	840,0	12200	50,8	2,00	0,18	0,12
EC118-06L	9,5	0,38	15,5	0,61	210,0	3050	840,0	12200	63,5	2,50	0,27	0,18
EC118-08L	12,7	0,50	19,0	0,75	210,0	3050	840,0	12200	88,9	3,50	0,36	0,24
EC118-10L	15,9	0,62	23,8	0,94	210,0	3050	840,0	12200	101,6	4,00	0,69	0,46
EC118-12L	19,0	0,75	27,7	1,09	210,0	3050	840,0	12200	120,7	4,75	0,81	0,54
EC118-16L	25,4	1,00	36,0	1,42	210,0	3050	840,0	12200	152,4	6,00	1,21	0,81

Typical Application:

Low and medium pressure hydraulic systems with petroleum and water-based fluids
Construction equipment and agriculture equipment

Agency Specifications:

MSHA
USCG

Operating Temperature: -40°C to +100°C (-40°F to +212°F)

Fittings: 1A-Series | Two-piece Winner

EC082 Pilot line hydraulic hose

Meets: MSHA IC-84/41

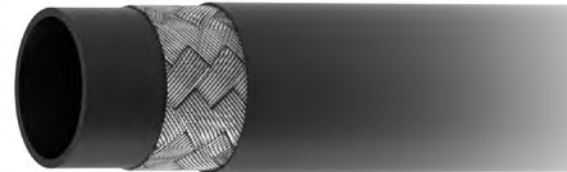

Layline example:

Winner by Danfoss **EC082-04** 6.4 MM (0.25 IN) DN6 | 150 BAR (2175 PSI) -40°C to +100°C (-40°F to +212°F) 2pc

Construction: Inner Tube: Synthetic rubber **Reinforcement:** One steel braid **Cover:** Synthetic rubber

PART #	SIZE DIMENSIONS				PRESSURE				BEND		WEIGHT	
	Hose I.D.		Hose O.D. (nominal)		Working Pressure		Min. Burst Pressure		Min. Bend Radius		Weight	
	mm	in	mm	in	bar	psi	bar	psi	mm	in	kg/m	lbs/ft
EC082-04	6,4	0,25	11,5	0,45	150	2175	600	8700	25	0,98	0,15	0,10
EC082-06	9,5	0,38	14,8	0,58	120	1750	480	7000	40	1,57	0,20	0,13

Typical Application:

Hydraulic system service with petroleum and water based fluids, for general industrial service.

Agency Specifications:

MSHA

Operating Temperature: -40°C to +100°C (-40°F to +212°F)

Fittings: Two-piece Winner (00110-04FEWZD, 00110-06EEWZD)

EC420 Hydraulic hose

Meets: SAE 100R13 • ISO 18752



Layline Example:

Winner by Danfoss **EC420-16** 25.4 MM (1.00 IN) DN25 | SAE 100R13 • EN 856 R13 • ISO 18752 | MSHA IC-84/41 • DNV • USCG ⚡ | 350 BAR (5100 PSI) -40°C to +121°C / -40°F to +250°F | Half Bend 4S

Construction: Inner Tube: Synthetic rubber Reinforcement: 4 wire spiral: -12, -16; 6 wire spiral: -20 to -32 Cover: Synthetic rubber

PART #	SIZE DIMENSIONS				PRESSURE				BEND		WEIGHT	
	Hose I.D.		Hose O.D. (nominal)		Working Pressure		Min. Burst Pressure		Min. Bend Radius		Weight	
	mm	in	mm	in	bar	psi	bar	psi	mm	in	kg/m	lbs/ft
EC420-12	19.0	0.75	32.1	1.27	350	5,100	1,400	20,400	120	4.72	1.54	1.03
EC420-16	25.4	1.00	38.7	1.53	350	5,100	1,400	20,400	150	5.91	2.01	1.35
EC420-20	31.8	1.25	49.8	1.96	350	5,100	1,400	20,400	210	8.27	3.78	2.54
EC420-24	38.1	1.50	57.3	2.26	350	5,100	1,400	20,400	250	9.84	4.73	3.18
EC420-32	50.8	2.00	71.6	2.82	350	5,100	1,400	20,400	320	12.60	6.26	4.21

Typical Application:
Suitable for use in hydraulic systems with high peak pressures and arduous operating conditions.

Agency Specifications:
MSHA
USCG
DNV

Operating Temperature: -40°C to +121°C (-40°F to +250°F)

Fittings: 4S series (-12, -16), 6S series (-20, -24, -32)

EC426 Hydraulic hose

Meets: EN856 4SP



Layline example:

Winner by Danfoss **EC426-12** 19 mm (0.75 in) DN19 | EN856 4SP MSHA IC-84/41 | 350 BAR (5100 PSI) -40°C to +100°C / -40°F to +212°F | 4S

Construction: Inner Tube: Synthetic rubber Reinforcement: Four wire spiral Cover: Synthetic rubber

PART #	SIZE DIMENSIONS					PRESSURE				BEND		WEIGHT	
	Hose I.D.			Hose O.D. (nominal)		Working Pressure		Min. Burst Pressure		Min. Bend Radius		Weight	
	DN	mm	in	mm	in	bar	psi	bar	psi	mm	in	kg/m	lbs/ft
EC426-06	10	9.5	0.37	20.9	0.82	445	6,450	1,780	25,800	180	7.09	0.74	0.50
EC426-08	12	12.7	0.50	25.4	1.00	415	6,000	1,660	24,000	230	9.06	0.88	0.59
EC426-10	16	15.9	0.62	29.0	1.14	350	5,100	1,400	20,400	250	9.84	1.04	0.70
EC426-12	19	19.0	0.75	33.0	1.30	350	5,100	1,400	20,400	300	11.81	1.47	0.99
EC426-16	25	25.4	1.00	40.9	1.61	280	4,050	1,120	16,200	340	13.39	1.90	1.28
EC426-20*	31	31.8	1.25	48.6	1.91	210	3,050	840	12,200	460	18.11	2.46	1.65

*Only bulk hose

Operating Temperature: -40°C to +100°C (-40°F to +212°F)

Fittings: 1T series (-6,-8,-10) 4S series (-12,-16)

Typical Application:
Hydraulic systems service with petroleum and water based fluids, for general use.

Agency Specifications:
MSHA

Winner spiral hoses

EC512 Hydraulic hose

Meets: EN856 4SH



Layline example:

Winner by Danfoss **EC512-16** 25.4 MM (1.00 IN) DN25 | EN856 4SH MSHA IC-84/41 - DNV | **380 BAR (5500 PSI)** -40°C to +100°C -40°F to +212°F **4S**

Construction: Inner Tube: Synthetic rubber Reinforcement: Four wire spiral Cover: Synthetic rubber

PART #	SIZE DIMENSIONS				PRESSURE				BEND		WEIGHT		
	Hose I.D.		Hose O.D. (nominal)		Working Pressure		Min. Burst Pressure		Min. Bend Radius		Weight		
	DN	mm	in	mm	in	bar	psi	bar	psi	mm	in	kg/m	lbs/ft
EC512-12	19	19	0.75	33.0	1.30	420	6,100	1,680	24,400	280	11.02	1.47	0.99
EC512-16	25	25.4	1.00	39.9	1.57	380	5,500	1,520	22,000	340	13.39	2.04	1.37
EC512-20	31	31.8	1.25	47.1	1.85	350	5,100	1,400	20,400	460	18.11	2.39	1.61
EC512-24	38	38.1	1.05	55.1	2.17	290	4,200	1,160	16,800	560	22.05	3.19	2.14
EC512-32	51	50.8	2.00	69.7	2.74	250	3,650	1,000	14,600	700	27.56	4.37	2.94

Operating Temperature: -40°C to +100°C (-40°F to +212°F)

Fittings: 4S Series (-12, -16, -20, -24, -32)

Typical Application:

Hydraulic systems service with petroleum and water based fluids, for general use.

Agency Specifications:

MSHA
DNV

EC615 Hydraulic hose

Meets: ISO 18752 • SAE 100R15 • EN 856 R13

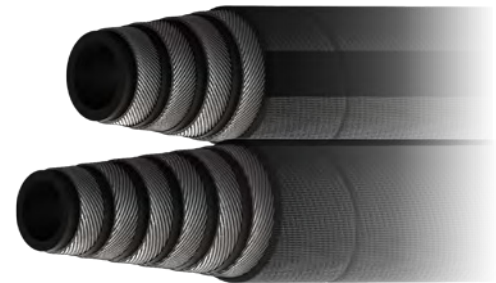

Layline example:

Winner by Danfoss **EC615-16** 25.4 MM (1.00 IN) DN25 | SAE 100R15 • EN 856 R13 ISO 18752 • MSHA IC-84/41 • DNV | **420 BAR (6100 PSI)** -40°C to +121°C -40°F to +250°F **4S**

Construction: Inner Tube: Synthetic rubber Reinforcement: Four & six wire spiral reinforcement Cover: Synthetic rubber

PART #	SIZE DIMENSIONS				PRESSURE				BEND		WEIGHT	
	Hose I.D.		Hose O.D. (nominal)		Working Pressure		Min. Burst Pressure		Min. Bend Radius		Weight	
	mm	in	mm	in	bar	psi	bar	psi	mm	in	kg/m	lbs/ft
EC615-16	25.4	1.00	39.9	1.57	420	6,100	1,680	24,400	330	12.99	2.00	1.35
EC615-20	31.8	1.25	51.3	2.02	420	6,100	1,680	24,400	445	17.52	3.77	2.53
EC615-24	38.1	1.50	58.8	2.31	420	6,100	1,680	24,400	530	20.87	5.17	3.47
EC615-32*	50.8	2.00	72.8	2.87	420	6,100	1,680	24,400	600	23.62	7.26	4.88

* Only bulk hose

Operating Temperature: -40°C to +121°C (-40°F to +250°F)

Fittings: 4S series (-16) 6S series (-20, -24)

Typical Application:

Suitable for use in hydraulic and oil systems.

Agency Specifications:

MSHA
DNV

EC640 Core Standard Winner

Meets: Exceeds ISO 18752-CC, SAE100 R15

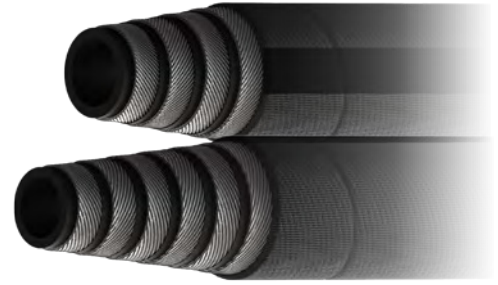

Layline example:

Winner by Danfoss **EC640-12** 19.0 MM (0.75 IN) DN19 | SAE 100R15 • ISO 18752 MSHA IC-84/43 | **420 BAR (6100 PSI)** | -40°C to +120°C -40°F to +248°F | **Half Bend**

Construction: Inner Tube: Synthetic rubber Reinforcement: 4-wire spiral (-6 to -16) 6-wire spiral (-20, -24, -32) Cover: Synthetic rubber

PART #	SIZE				PRESSURE				BEND		WEIGHT	
	Hose I.D.		Hose O.D. (nominal)		Working Pressure		Min. Burst Pressure		Min. Bend Radius		Weight	
	mm	in	mm	in	bar	psi	bar	psi	mm	in	kg/m	lbs/ft
EC640-06	9.5	0.37	20.9	0.82	420	6100	1680	24360	65	2.56	0.70	0.47
EC640-08	12.7	0.50	24.0	0.94	420	6100	1680	24360	90	3.54	0.92	0.62
EC640-10	15.9	0.63	27.7	1.09	420	6100	1680	24360	100	3.94	1.13	0.76
EC640-12	19.0	0.75	30.7	1.21	420	6100	1680	24360	150	5.91	1.25	0.84
EC640-16	25.4	1.00	37.9	1.49	420	6100	1680	24360	210	8.27	1.83	1.23
EC640-20	31.8	1.25	49.6	1.95	420	6100	1680	24360	260	10.24	3.17	2.13
EC640-24	38.1	1.50	56.9	2.24	420	6100	1680	24360	310	12.20	4.40	2.95
EC640-32	50.8	2.00	71.4	2.81	420	6100	1680	24360	350	13.78	6.28	4.22

Operating Temperature: -40°C to +120°C (-40°F to +248°F)

Fittings: 4S Series, 6S Series, 1W Series

Typical Application:

For hydraulic systems with high peak pressure and arduous operating conditions such as high pressure hydraulic circuits (for example on booms) on mobile construction equipment, mining equipment, and agricultural machines.

Agency Specifications:

MSHA, ABS, USCG

WH004 Suction & Return hose

Meets: SAE 100R4

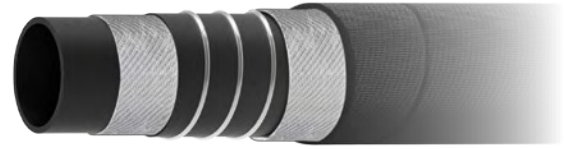

Layline Example:

Winner by Danfoss **WH004-12** 19 mm (0.75 in) DN19 | SAE 100R4 MSHA IC-261/5 | 21 BAR (305 PSI) | -40°C to +100°C (-40°F to +212°F) 1A 1G • 2 pc

Construction: Inner Tube: Oil resistant NBR Reinforcement: Textile with helical and anti-static wire Cover: Abrasion Resistant Synthetic rubber

PART #	SIZE DIMENSIONS				PRESSURE				BEND		VACUUM		WEIGHT	
	Hose I.D.		Hose O.D. (nominal)		Working Pressure		Min. Burst Pressure		Min. Bend Radius		Vacuum		Weight	
	mm	in	mm	in	bar	psi	bar	psi	mm	in	kPa	in/Hg	kg/m	lbs/ft
WH004-12	19.0	0.75	30.0	1.18	21	305	84	1220	40	1.57	94.8	28	0,54	0.36
WH004-16	25.4	1.00	36.2	1.43	17	245	68	980	45	1.77	94.8	28	0,68	0.46
WH004-20	31.8	1.25	43.0	1.69	14	205	56	820	60	2.36	94.8	28	0,85	0.57
WH004-24	38.1	1.50	50.2	1.98	10.5	150	42	600	65	2.56	94.8	28	1,20	0.81
WH004-32	50.8	2.00	63.2	2.49	7	100	28	400	100	3.94	94.8	28	1,53	1.03
WH004-40*	53.5	2.50	76.7	3.02	4	60	16	240	140	5.51	94.8	28	2,05	1.38
WH004-48*	76.2	3.00	89.4	3.52	4	60	16	240	180	7.09	94.8	28	2,62	1.76

Typical Application:

Suitable for use in suction applications for hydraulics, crude fuel, lubricating oils, gasoline, air, water and chemical transfer

Agency Specifications:

MSHA

*Only bulk hose

Operating Temperature: -40° C to +100° C (-40° to +212° F)

Fittings: 1A and 1G and 2 pieces: (-12, 16, -20, -24, -32)

WH005 Textile hose

Meets: EN854 1TE • SAE 100R6

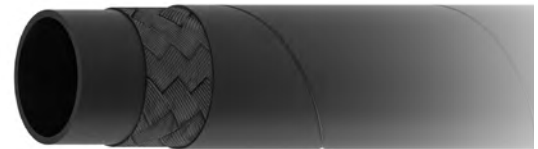

Layline example:

Winner by Danfoss **WH005-12** 19 mm (0.75 in) DN19 | Meets SAE 100R6 | 21 BAR (305 PSI) | -40°C to +100°C (-40°F to +212°F) 2 pc

Construction: Inner Tube: Synthetic rubber Reinforcement: One Synthetic Textile Braid Cover: Synthetic rubber

PART #	SIZE DIMENSIONS					PRESSURE				BEND		WEIGHT	
	Hose I.D.		Hose O.D. (nominal)			Working Pressure		Min. Burst Pressure		Min. Bend Radius		Weight	
	DN	mm	in	mm	in	bar	psi	bar	psi	mm	in	kg/m	lbs/ft
WH005-03	5	4.8	0.19	10.7	0.42	35	508	140	2030	35	1.38	0.09	0.06
WH005-04	6	6.4	0.25	12.3	0.48	28	406	112	1624	45	1.77	0.11	0.07
WH005-05	8	7.9	0.31	13.9	0.55	28	406	112	1624	65	2.56	0.13	0.08
WH005-06	10	9.5	0.37	15.5	0.61	28	406	112	1624	75	2.95	0.15	0.10
WH005-08	12	12.7	0.50	19.7	0.77	28	406	112	1624	90	3.54	0.23	0.15
WH005-10	16	16.2	0.64	22.6	0.89	24	348	94	1392	115	4.53	0.26	0.17
WH005-12	19	19.2	0.76	25.8	1.02	21	305	84	1218	140	5.51	0.32	0.21
WH005-16	25	25.4	1.00	33.2	1.31	20	290	80	1160	150	5.91	0.47	0.32

Typical Application:

For Hydraulic Control Lines; Hydraulic systems service with Petroleum and water based fluids for low pressure industrial service

Operating Temperature: -40°C to +100°C (-40°F to +212°F)

Fittings: Two-piece Winner

Winner textile hoses

WH006 Textile hose

Meets: SAE 100R6 • EN 854 2TE

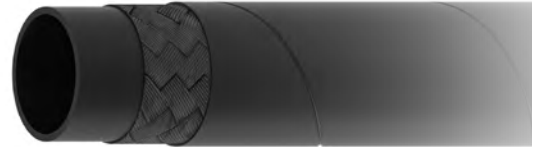

Layline example:

Winner by Danfoss **WH006-12** 19.0 MM (0.75 IN) DN19 | SAE 100R6 / EN 854 2TE | **70 BAR (655 PSI)** 2pc

Construction: Inner Tube: Synthetic rubber **Reinforcement:** One Synthetic Textile Braid **Cover:** Synthetic rubber cover

PART #	SIZE DIMENSIONS					PRESSURE				BEND		WEIGHT	
	Hose I.D.			Hose O.D. (nominal)		Working Pressure		Min. Burst Pressure		Min. Bend Radius		Weight	
	DN	mm	in	mm	in	bar	psi	bar	psi	mm	in	kg/m	lbs/ft
WH006-03	5	4.8	0.19	11.8	0.46	80	1160	320	4640	35	1.38	0.12	0.08
WH006-04	6	6.4	0.25	13.4	0.53	75	1088	300	4350	40	1.57	0.15	0.10
WH006-05	8	7.9	0.31	14.9	0.59	68	986	272	3944	50	1.97	0.17	0.11
WH006-06	10	9.5	0.37	16.5	0.65	63	914	252	3654	60	2.36	0.20	0.13
WH006-08	12	12.7	0.50	19.7	0.78	58	841	232	3364	70	2.67	0.24	0.16
WH006-10	16	15.9	0.63	23.9	0.94	50	725	200	2900	90	3.54	0.33	0.22
WH006-12	19	19.0	0.75	27.0	1.06	45	653	180	2610	110	4.33	0.38	0.26
WH006-16	25	25.4	1.00	34.4	1.35	40	580	160	2320	150	5.91	0.55	0.37

Typical Application:

For Hydraulic Control Lines; Hydraulic systems service with Petroleum and water based fluids for low pressure industrial service

Operating Temperature: -40°C to +100°C (-40°F to +212°F)

Fittings: Two-piece Winner

WH007 Textile hose

Meets: EN 854 3TE

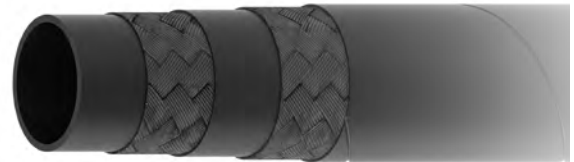

Layline example:

Winner by Danfoss **WH007-12** 19.0 MM (0.75 IN) DN19 | EN 854 3TE MSHA IC-84/55 | **70 BAR (1000 PSI)** 2pc

Construction: Inner Tube: Synthetic rubber **Reinforcement:** Two Synthetic Textile Braid **Cover:** Synthetic rubber

PART #	SIZE DIMENSIONS					PRESSURE				BEND		WEIGHT	
	Hose I.D.			Hose O.D. (nominal)		Working Pressure		Min. Burst Pressure		Min. Bend Radius		Weight	
	DN	mm	in	mm	in	bar	psi	bar	psi	mm	in	kg/m	lbs/ft
WH007-04	6	6.4	0.25	13.4	0.53	145	2103	580	8410	45	1.77	0.15	0.10
WH007-05	8	7.9	0.31	14.9	0.59	130	1885	520	7540	55	2.17	0.17	0.11
WH007-06	10	9.5	0.37	16.5	0.65	110	1595	440	6380	70	2.76	0.20	0.13
WH007-08	12	12.7	0.50	19.7	0.78	93	1349	372	5394	85	3.35	0.24	0.16
WH007-10	16	15.9	0.63	23.9	0.94	80	1160	320	4640	105	4.13	0.33	0.22
WH007-12	19	19.0	0.75	27.0	1.06	70	1015	280	4060	130	5.12	0.38	0.26
WH007-16	25	25.4	1.00	34.4	1.35	55	798	220	3190	150	5.91	0.55	0.37
WH007-20*	31	31.8	1.25	35.4	1.39	45	653	180	2610	190	7.48	1.55	1.04

* Only bulk hose

Operating Temperature: -40°C to +100°C (-40°F to +212°F)

Fittings: Two-piece Winner

Typical Application:

For Hydraulic Control Lines; Hydraulic systems service with Petroleum and water based fluids for low pressure industrial service

Agency Specifications:

MSHA

Winner thermoplastic hoses

WHR7

Thermoplastic hydraulic hose

Meets: SAE100 R7

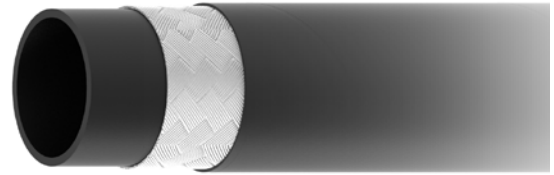

Layline Example:

Winner by Danfoss **WHR7-12** 19.2 mm (0.76 in) DN19 | SAE100 R7 | **88 BAR (1276 PSI)** 2 pc

Construction: Inner Tube: Nylon Reinforcement: 1-textile Braid Cover: Perforated Polyurethane

PART #	SIZE DIMENSIONS					PRESSURE				BEND		WEIGHT	
	Hose I.D.			Hose O.D. (nominal)		Working Pressure		Min. Burst Pressure		Min. Bend Radius		Weight	
	DN	mm	in	mm	in	bar	psi	bar	psi	mm	in	kg/m	lbs/ft
WHR7-02	3	3.5	0.14	8.4	0.33	210	3045	840	12180	13	0.51	0.05	0.03
WHR7-03	5	4.8	0.19	9.9	0.39	210	3045	840	12180	35	1.38	0.06	0.04
WHR7-04	6	6.4	0.25	12.7	0.50	210	3045	840	12180	45	1.77	0.10	0.07
WHR7-05	8	7.9	0.31	14.4	0.57	175	2538	700	10150	60	2.36	0.13	0.09
WHR7-06	10	9.5	0.37	15.5	0.61	157	2277	628	9106	70	2.76	0.13	0.09
WHR7-08	12	12.7	0.50	19.9	0.78	140	2030	560	8120	90	3.54	0.20	0.13
WHR7-10	16	16.2	0.64	24.7	0.97	105	1523	420	6090	115	4.53	0.27	0.18
WHR7-12	19	19.2	0.76	28.0	1.10	88	1276	350	5104	127	5.00	0.31	0.21
WHR7-16	25	25.4	1.00	35.7	1.41	70	1015	280	4060	203	7.99	0.48	0.32

Typical Application:

- Material handling
- Access platforms
- Agriculture
- Chemical transfer
- Foam systems
- Food processing
- General construction
- General hydraulic systems
- Lubrication systems

Operating Temperature: -40°C to +100°C (-40°F to +212°F)

Fittings: Two-piece Winner

WHR8

Thermoplastic hydraulic hose

Meets: SAE100 R8



Layline example:

Winner by Danfoss **WHR8-12** 25.4 mm (1.00 in) DN25 | SAE100 R8 | **140 BAR (2030 PSI)** 2 pc

Construction: Inner Tube: Nylon Reinforcement: 2 or 3-textile Braids Cover: Perforated Polyurethane

PART #	SIZE DIMENSIONS					PRESSURE				BEND		WEIGHT	
	Hose I.D.			Hose O.D. (nominal)		Working Pressure		Min. Burst Pressure		Min. Bend Radius		Weight	
	DN	mm	in	mm	in	bar	psi	bar	psi	mm	in	kg/m	lbs/ft
WHR8-04	6	6.4	0.25	15.9	0.63	350	5075	1400	20300	51	2.00	0.18	0.12
WHR8-06	10	9.5	0.37	19.4	0.76	280	4060	1120	16240	64	2.50	0.22	0.15
WHR8-08	12	12.7	0.50	22.7	0.89	245	3553	980	14210	102	4.00	0.28	0.19
WHR8-12	19	19.0	0.75	28.9	1.14	157	2277	628	9106	165	6.50	0.38	0.26
WHR8-16	25	25.4	1.00	37.3	1.47	140	2030	560	8120	254	10.00	0.57	0.38

Typical Application:

- General hydraulic systems
- Hydraulic tools
- Mobile equipment
- High pressure pneumatic systems
- High pressure chemical transfer

Operating Temperature: -40°C to +100°C (-40°F to +212°F)

Fittings: Two-piece Winner

Winner thermoplastic hoses

WHR18 Thermoplastic hydraulic hose

Meets: SAE100 R18



Layline example:

Winner by Danfoss **WHR18-06** 9.5 mm (0.37 in) DN10 | SAE100 R18 | 210 BAR (3045 PSI) -40°C to +100°C (-40°F to +212°F) 2 pc

Construction: Inner Tube: Polimeric core tube Reinforcement: 2 or 3-textile Braids Cover: Perforated Polyurethane

PART #	SIZE DIMENSIONS					PRESSURE				BEND		WEIGHT	
	Hose I.D.			Hose O.D. (nominal)		Working Pressure		Min. Burst Pressure		Min. Bend Radius		Weight	
	DN	mm	in	mm	in	bar	psi	bar	psi	mm	in	kg/m	lbs/ft
WHR18-03	5	4.8	0.19	10.7	0.42	210	3045	840	12180	25	1.00	0.08	0.05
WHR18-04	6	6.4	0.25	12.1	0.48	210	3045	840	12180	32	1.25	0.09	0.06
WHR18-05	8	7.9	0.31	15.5	0.61	210	3045	840	12180	38	1.50	0.15	0.10
WHR18-06	10	9.5	0.37	16.8	0.66	210	3045	840	12180	51	2.00	0.18	0.12
WHR18-08	12	12.7	0.50	21.6	0.85	210	3045	840	12180	89	3.50	0.25	0.17
WHR18-10	16	15.9	0.63	27.0	1.06	210	3045	840	12180	102	4.00	0.41	0.28

Typical Application:

- General hydraulics systems
- Forklifts
- Construction
- Agricultural equipment
- Lubrication equipment
- Material handling

Operating Temperature: -40°C to +93°C (-40°F to +200°F)

Fittings: Two-piece Winner

WHR7L Low temperature thermoplastic hydraulic hose

Meets: SAE 100R7

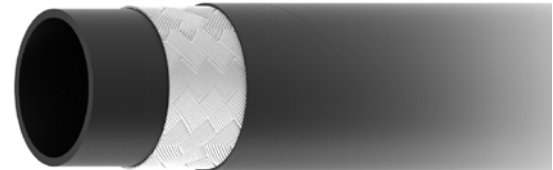

Layline example:

Winner by Danfoss **WHR7L-06** 9.5 mm (0.37 in) DN10 | SAE 100R7 | 158 BAR (2300 PSI) -40°C to +100°C (-40°F to +212°F) 2 pc

Construction: Inner Tube: Polyurethane Reinforcement: 1-textile Braid Cover: Polyester

PART #	SIZE DIMENSIONS					PRESSURE				BEND		WEIGHT	
	Hose I.D.			Hose O.D. (nominal)		Working Pressure		Min. Burst Pressure		Min. Bend Radius		Weight	
	DN	mm	in	mm	in	bar	psi	bar	psi	mm	in	kg/m	lbs/ft
WHR7L-03	5	4.8	0.19	10.8	0.43	210	3050	840	12200	20	0.79	0.10	0.07
WHR7L-04	6	6.4	0.25	13.1	0.52	193	2800	770	11168	32	1.26	0.14	0.10
WHR7L-05	8	7.9	0.31	14.9	0.59	175	2550	700	10200	45	1.77	0.14	0.10
WHR7L-06	10	9.5	0.37	16.6	0.65	158	2300	630	9137	51	2.01	0.17	0.11

Typical Application:

- Access platforms
- Forklift
- General construction
- General hydraulic systems

Operating Temperature: -54°C to +100°C (-65°F to +212°F)

Fittings: Two-piece Winner

Standard and premium fittings - the **right** product for every **application**

Braided or spiral, premium or standard, there is a Danfoss fitting for each of your application.



Two-piece fittings

For use with hose: EC115, EC215, EC110, EC210

EC110-EC115 Socket

#	HOSE SIZE INFO		DIMENSIONS				WEIGHT	
	DN	Dash Size	A		OD		Weight	
			mm	in	mm	in	kg	lb
00110-04AEWZD	6	-04	27,5	1.08	21,0	0.83	0,03	0.07
00110-05AEWZD	8	-05	28,0	1.10	21,5	0.85	0,03	0.06
00110-06AEWZD	10	-06	30,0	1.18	24,3	0.96	0,04	0.08
00110-08AEWZD	12	-08	34,0	1.34	28,0	1.10	0,05	0.10
00110-10AEWZD	16	-10	37,0	1.46	31,3	1.23	0,06	0.13
00110-12AEWZD	20	-12	42,0	1.65	28,7	1.13	0,08	0.17
00110-16AEWZD	25	-16	51,0	2.01	43,5	1.71	0,13	0.28
00110-20EWZD	32	-20	59,0	2.32	52,0	2.05	0,21	0.46
00110-24EWZD	40	-24	74,0	2.91	58,0	2.28	0,27	0.58
00110-32EWZD	50	-32	78,0	3.07	72,0	2.83	0,39	0.86

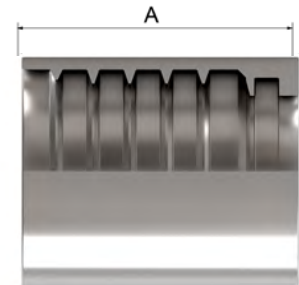

EC210-EC215-WH004 Socket

#	HOSE SIZE INFO		DIMENSIONS				WEIGHT	
	DN	Dash Size	A		OD		Weight	
			mm	in	mm	in	kg	lb
03310-04EWZD	6	-04	30,5	1.20	23,0	0.91	0,04	0.09
03310-05EWZD	8	-05	30,0	1.18	24,0	0.94	0,04	0.08
03310-06EWZD	10	-06	32,0	1.26	26,0	1.02	0,04	0.09
03310-08EWZD	12	-08	34,0	1.34	29,0	1.14	0,05	0.10
03310-10AEWZD	16	-10	35,0	1.38	34,5	1.36	0,06	0.14
03310-12EWZD	20	-12	42,0	1.65	37,0	1.46	0,08	0.18
03310-16EWZD	25	-16	52,0	2.05	46,7	1.84	0,15	0.33
03310-20AEWZD	32	-20	59,0	2.32	59,0	2.32	0,26	0.57
03310-24AEWZD	40	-24	67,0	2.64	67,0	2.64	0,43	0.94
03310-32AEWZD	50	-32	72,0	2.83	80,0	3.15	0,61	1.34

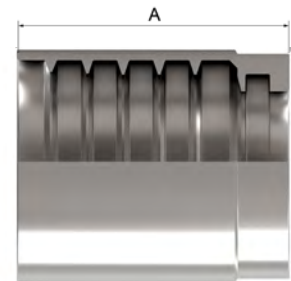

WHR7-WHR8-WHR18-WH005-WH006-WH007 Socket

#	HOSE SIZE INFO		DIMENSIONS				WEIGHT	
	DN	Dash Size	A		OD		Weight	
			mm	in	mm	in	kg	lb
000T8-02EWZD	3	-02	20.5	0.81	12.05	0.47	0.02	0.05
000T8-03EWZD	5	-03	23.0	0.91	17.15	0.68	0.02	0.06
000T8-04EWZD	6	-04	30.5	1.20	20.98	0.83	0.03	0.06
000T8-05EWZD	8	-05	30.0	1.18	22.00	0.87	0.03	0.07
000T8-06EWZD	10	-06	32.0	1.26	24.43	0.96	0.04	0.08
000T8-08EWZD	12	-08	34.0	1.34	27.76	1.09	0.05	0.10
000T8-10EWZD	16	-10	37.0	1.46	34.62	1.36	0.06	0.13
000T8-12EWZD	19	-12	42.0	1.65	33.32	1.31	0.08	0.17
000T8-16EWZD	25	-16	51.0	2.01	44.75	1.76	0.13	0.28

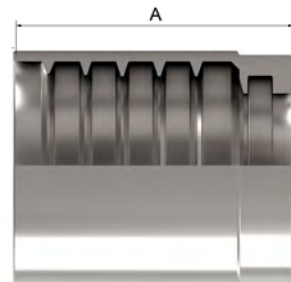

Two-piece fittings

For use with hose: EC115, EC215, EC110, EC210, WH004, WH005, WH006, WH007, WHR7, WHR8, WHR18

DIN 24° LIGHT DUTY

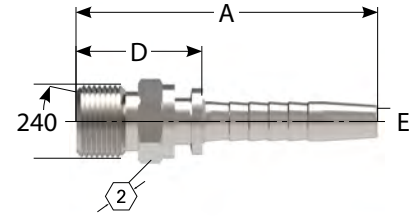

DIN 24° Male Rigid (DKO Light)

PART		HOSE SIZE INFO			DIMENSIONS								WEIGHT	
#	Terminal End	Thread	Hose Size	A	D Cut Off Factor		E Ø		1	2	Weight			
	Dash Size		DN	Dash Size	mm	in	mm	in	mm	in	mm	mm	kg	lb
10411-12-04Z	-12	M12x1.5	6	-04	48,5	1.91	20,5	0.81	4,0	0.16	--	12	0,015	0.033
10411-14-04Z	-14	M14x1.5	6	-04	48,5	1.91	20,5	0.81	4,0	0.16	--	14	0,020	0.044
10411-14-05Z	-14	M14x1.5	8	-05	49,5	1.95	21,5	0.85	5,5	0.22	--	14	0,020	0.044
10411-16-04Z	-16	M16x1.5	6	-04	50,5	1.99	22,5	0.89	4,0	0.16	--	17	0,025	0.055
10411-16-05Z	-16	M16x1.5	8	-05	50,5	1.99	22,5	0.89	5,5	0.22	--	17	0,025	0.055
10411-16-06Z	-16	M16x1.5	10	-06	52,5	2.07	22,5	0.89	7,0	0.28	--	17	0,034	0.075
10411-18-04Z	-18	M18x1.5	6	-04	51,5	2.03	23,5	0.93	4,0	0.16	--	19	0,030	0.066
10411-18-05Z	-18	M18x1.5	8	-05	51,5	2.03	23,5	0.93	5,5	0.22	--	19	0,030	0.066
10411-18-06Z	-18	M18x1.5	10	-06	52,5	2.07	22,5	0.89	7,0	0.28	--	19	0,035	0.077
10411-18-08Z	-18	M18x1.5	12	-08	55,5	2.19	24,0	0.95	10,0	0.39	--	19	0,045	0.099
10411-22-06Z	-22	M22x1.5	10	-06	54,5	2.15	24,5	0.96	7,0	0.28	--	24	0,050	0.110
10411-22-08Z	-22	M22x1.5	12	-08	57,5	2.26	26,0	1.02	10,0	0.39	--	24	0,060	0.132
10411-26-08Z	-26	M26x1.5	12	-08	58,0	2.28	26,5	1.04	10,0	0.39	--	27	0,076	0.167
10411-26-10Z	-26	M26x1.5	16	-10	60,5	2.38	26,5	1.04	12,0	0.47	--	27	0,080	0.176
10411-30-12Z	-30	M30x2	20	-12	68,5	2.70	30,0	1.18	15,0	0.59	--	32	0,122	0.268
10411-36-12Z	-36	M36x2	20	-12	69,5	2.75	31,0	1.22	15,0	0.59	--	38	0,164	0.361
10411-36-16Z	-36	M36x2	25	-16	78,5	3.09	31,5	1.24	21,0	0.83	--	38	0,178	0.392
10411-45-20Z	-45	M45x2	32	-20	91,0	3.58	37,0	1.46	27,0	1.06	--	46	0,310	0.682
10411-52-24Z	-52	M52x2	40	-24	106,0	4.17	38,0	1.50	32,0	1.26	--	55	0,460	1.012

Two-piece fittings

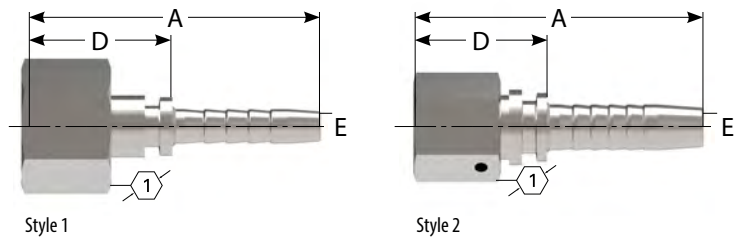

DIN 24° Female Swivel (DKO Light)

PART #	HOSE SIZE INFO			DIMENSIONS								WEIGHT		
	Terminal End	Thread	Hose Size	A		D Cut Off Factor		E Ø		1	2	kg	lb	
	Dash Size		DN	Dash Size	mm	in	mm	in	mm	in	mm	mm		
20411-12-04WZ**	-12	M12X1.5	6	-04	50,0	1.97	22,5	0.89	4,0	0.16	17	--	0,032	0.071
20411-14-04TZ**	-14	M14X1.5	6	-04	50,5	1.99	22,5	0.89	4,0	0.16	17	--	0,030	0.066
20411-14-05WZ**	-14	M14X1.5	8	-05	50,5	1.99	22,5	0.89	5,5	0.22	17	--	0,032	0.071
20411-14-06WZ**	-14	M14X1.5	10	-06	53,0	2.09	23,0	0.91	7,0	0.28	17	--	0,035	0.077
20411-16-04TZ*	-16	M16X1.5	6	-04	48,5	1.91	20,5	0.81	4,0	0.16	19	--	0,032	0.071
20411-16-05TZ**	-16	M16X1.5	8	-05	50,0	1.97	22,0	0.87	5,5	0.22	19	--	0,038	0.084
20411-16-06WZ**	-16	M16X1.5	10	-06	53,5	2.11	23,5	0.93	7,0	0.28	19	--	0,044	0.097
20411-18-04TZ*	-18	M18X1.5	6	-04	52,5	2.07	24,5	0.96	4,0	0.16	22	--	0,047	0.104
20411-18-05TZ*	-18	M18X1.5	8	-05	52,5	2.07	24,5	0.96	5,5	0.22	22	--	0,055	0.121
20411-18-06TZ*	-18	M18X1.5	10	-06	57,5	2.26	27,5	1.08	7,0	0.28	22	--	0,055	0.121
20411-18-08WZ**	-18	M18X1.5	12	-08	56,0	2.2	24,5	0.96	10,0	0.39	22	--	0,064	0.141
20411-22-10WZ**	-22	M22X1.5	16	-10	60,0	2.36	26,0	1.02	12,0	0.47	27	--	0,105	0.231
20411-22-04TZ*	-22	M22X1.5	6	-04	54,5	2.15	26,5	1.04	4,0	0.16	27	--	0,075	0.165
20411-22-05TZ*	-22	M22X1.5	8	-05	54,5	2.15	26,5	1.04	5,5	0.22	27	--	0,078	0.172
20411-22-06TZ*	-22	M22X1.5	10	-06	56,5	2.22	26,5	1.04	7,0	0.28	27	--	0,084	0.185
20411-22-08TZ*	-22	M22X1.5	12	-08	60,5	2.38	29,0	1.14	10,0	0.39	27	--	0,076	0.168
20411-26-10TZ*	-26	M26X1.5	16	-10	64,0	2.52	30,0	1.18	12,0	0.47	32	--	0,120	0.265
20411-26-12WZ**	-26	M26X1.5	20	-12	67,0	2.64	27,5	1.08	15,0	0.59	32	--	0,145	0.32
20411-26-08TZ*	-26	M26X1.5	12	-08	59,0	2.32	27,5	1.08	10,0	0.39	32	--	0,118	0.26
20411-30-10TZ*	-30	M30X2	16	-10	65,0	2.56	31,0	1.22	12,0	0.47	36	--	0,150	0.331
20411-30-12TZ*	-30	M30X2	20	-12	72,5	2.85	34,0	1.34	15,0	0.59	36	--	0,185	0.408
20411-30-16WZ**	-30	M30X2	25	-16	77,5	3.05	30,5	1.2	21,0	0.83	36	--	0,212	0.467
20411-36-12TZ*	-36	M36X2	20	-12	71,5	2.81	33,0	1.3	15,0	0.59	41	--	0,205	0.452
20411-36-16WZ**	-36	M36X2	25	-16	77,0	3.03	30,0	1.18	21,0	0.83	41	--	0,235	0.518
20411-45-16TZ*	-45	M45X2	25	-16	84,0	3.31	37,0	1.46	21,0	0.83	50	--	0,433	0.955
20411-45-20TZ*	-45	M45X2	32	-20	91,5	3.6	37,5	1.48	27,0	1.06	50	--	0,485	1.069
20411-52-20TZ*	-52	M52X2	32	-20	92,5	3.64	38,5	1.52	27,0	1.06	60	--	0,500	1.102
20411-52-24TZ*	-52	M52X2	40	-24	106,5	4.19	38,5	1.52	32,0	1.26	60	--	0,620	1.367

* Denotes Style 1 design

** Denotes Style 2 wire nut design

Two-piece fittings

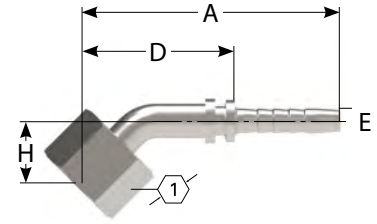

DIN 24° Female 45° Elbow (DKO Light)

PART		HOSE SIZE INFO			DIMENSIONS										WEIGHT	
#	Terminal End	Thread	Hose Size	A	D Cut Off Factor		E Ø		H		1	2	Weight			
	Dash Size	DN	Dash Size	mm	in	mm	in	mm	in	mm	in	mm	mm	kg	lb	
20441-12-04WZ**	-12	M12X1.5	6 -04	64	2.52	36	1.42	4	0.16	15,1	0.59	17	--	0.040	0.088	
20441-14-04TZ**	-14	M14X1.5	6 -04	66,1	2.60	38,1	1.50	4	0.16	16	0.63	17	--	0.040	0.088	
20441-16-04TZ*	-16	M16X1.5	6 -04	66,1	2.60	38,1	1.50	4	0.16	16	0.63	19	--	0.050	0.088	
20441-16-05TZ**	-16	M16X1.5	8 -05	68,3	2.69	40,3	1.59	5,5	0.22	17	0.67	19	--	0.054	0.119	
20441-16-06WZ**	-16	M16X1.5	10 -06	70,3	2.77	40,3	1.59	7	0.28	17	0.67	19	--	0.058	0.128	
20441-18-05TZ*	-18	M18X1.5	8 -05	68,3	2.69	40,3	1.59	5,5	0.22	17	0.67	22	--	0.070	0.154	
20441-18-06TZ*	-18	M18X1.5	10 -06	75	2.95	45	1.77	7	0.28	18,5	0.73	22	--	0.070	0.154	
20441-18-08WZ**	-18	M18X1.5	12 -08	75,7	2.98	44,2	1.74	10	0.39	18,7	0.74	22	--	0.086	0.190	
20441-22-10WZ**	-22	M22X1.5	16 -10	83	3.27	49	1.93	12	0.47	22,2	0.87	27	--	0.125	0.276	
20441-22-06TZ*	-22	M22X1.5	10 -06	72	2.83	42	1.65	7	0.28	18	0.71	27	--	0.096	0.212	
20441-22-08TZ*	-22	M22X1.5	12 -08	80,3	3.16	48,8	1.92	10	0.39	20	0.79	27	--	0.105	0.231	
20441-26-10TZ*	-26	M26X1.5	16 -10	73,5	2.89	58	2.28	12	0.47	23,5	0.93	32	--	0.178	0.392	
20441-26-12WZ**	-26	M26X1.5	20 -12	99,9	3.93	61,4	2.42	15	0.59	24,6	0.97	32	--	0.210	0.463	
20441-26-08TZ*	-26	M26X1.5	12 -08	78,8	3.10	47,3	1.86	10	0.39	21	0.83	32	--	0.154	0.340	
20441-30-10TZ*	-30	M30X2	16 -10	90,4	3.56	56,4	2.22	12	0.47	24,1	0.95	36	--	0.196	0.432	
20441-30-12TZ*	-30	M30X2	20 -12	101,7	4.00	63,2	2.49	15	0.59	25,6	1.01	36	--	0.240	0.529	
20441-36-12TZ*	-36	M36X2	20 -12	100	3.94	61,5	2.42	15	0.59	25,6	1.01	41	--	0.360	0.794	
20441-36-16WZ**	-36	M36X2	25 -16	124,6	4.91	77,6	3.06	21	0.83	32	1.26	41	--	0.388	0.855	
20441-45-16TZ*	-45	M45X2	25 -16	124,2	4.89	77,5	3.05	21	0.83	32	1.26	50	--	0.590	1.301	
20441-45-20TZ*	-45	M45X2	32 -20	145,7	5.74	88,7	3.49	27	1.06	38	1.50	50	--	0.716	1.579	
20441-52-20TZ*	-52	M52X2	32 -20	144,3	5.68	90,3	3.56	27	1.06	38	1.50	60	--	0.813	1.792	
20441-52-24TZ*	-52	M52X2	40 -24	185,5	7.30	114,5	4.51	32	1.26	43,7	1.72	60	--	1.100	2.425	

* Denotes Style 1 design

** Denotes Style 2 wire nut design

Two-piece fittings

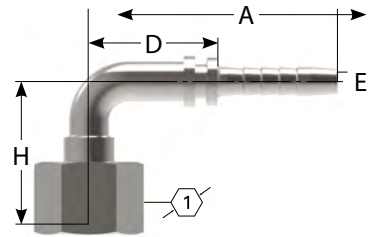

DIN 24° Female 90° Elbow (DKO Light)

PART		HOSE SIZE INFO			DIMENSIONS								WEIGHT			
#	Terminal End	Thread	Hose Size	A	D Cut Off Factor		E Ø		H	1	2	Weight				
	Dash Size	DN	Dash Size	mm	in	mm	in	mm	in	mm	mm	mm	mm	kg	lb	
20491-12-04WZ**	-12	M12X1.5	6	-04	55,0	2.17	27,0	1.06	4,0	0.16	30,0	1.18	17	--	0,040	0.088
20491-14-04Z**	-14	M14X1.5	6	-04	58,0	2.28	30,0	1.18	4,0	0.16	30,5	1.20	17	--	0,042	0.093
20491-14-05WZ**	-14	M14X1.5	8	-05	58,0	2.28	30,0	1.18	5,5	0.22	30,5	1.20	17	--	0,046	0.101
20491-14-06WZ**	-14	M14X1.5	10	-06	60,0	2.36	30,0	1.18	7,0	0.28	30,5	1.20	17	--	0,050	0.110
20491-16-04TZ*	-16	M16X1.5	6	-04	58,0	2.28	30,0	1.18	4,0	0.16	30,5	1.20	19	--	0,050	0.110
20491-16-05TZ**	-16	M16X1.5	8	-05	61,0	2.40	33,0	1.30	5,5	0.22	33,0	1.30	19	--	0,070	0.154
20491-16-06WZ**	-16	M16X1.5	10	-06	65,0	2.56	35,0	1.38	7,0	0.28	33,0	1.30	19	--	0,064	0.141
20491-18-04TZ*	-18	M18X1.5	6	-04	58,0	2.28	30,0	1.18	4,0	0.16	30,5	1.20	22	--	0,074	0.163
20491-18-05TZ*	-18	M18X1.5	8	-05	61,0	2.40	33,0	1.30	5,5	0.22	33,5	1.32	22	--	0,077	0.170
20491-18-06TZ*	-18	M18X1.5	10	-06	67,0	2.64	37,0	1.46	7,0	0.28	36,0	1.42	22	--	0,075	0.165
20491-18-08WZ**	-18	M18X1.5	12	-08	70,5	2.78	39,0	1.54	10,0	0.39	37,0	1.46	22	--	0,090	0.198
20491-22-10WZ**	-22	M22X1.5	16	-10	79,0	3.11	45,0	1.77	12,0	0.47	44,5	1.75	27	--	0,145	0.320
20491-22-05TZ*	-22	M22X1.5	8	-05	61,0	2.40	33,0	1.30	5,5	0.22	34,5	1.36	27	--	0,092	0.203
20491-22-06TZ*	-22	M22X1.5	10	-06	64,5	2.54	34,5	1.36	7,0	0.28	36,0	1.42	27	--	0,110	0.243
20491-22-08TZ*	-22	M22X1.5	12	-08	73,5	2.89	42,0	1.65	10,0	0.39	41,5	1.63	27	--	0,126	0.278
20491-26-10TZ*	-26	M26X1.5	16	-10	85,2	3.35	51,2	2.02	12,0	0.47	51,5	2.03	32	--	0,210	0.463
20491-26-12WZ**	-26	M26X1.5	20	-12	94,0	3.70	55,5	2.19	15,0	0.59	51,5	2.03	32	--	0,242	0.534
20491-26-08TZ*	-26	M26X1.5	12	-08	71,0	2.80	39,5	1.56	10,0	0.39	42,9	1.69	32	--	0,160	0.353
20491-30-10TZ*	-30	M30X2	16	-10	83,0	3.27	49,0	1.93	12,0	0.47	51,5	2.03	36	--	0,255	0.562
20491-30-12TZ*	-30	M30X2	20	-12	95,5	3.76	57,0	2.24	15,0	0.59	56,0	2.20	36	--	0,293	0.646
20491-30-16WZ*	-30	M30x2	25	-16	112,5	0.44	65,5	2.58	21,0	0.83	61,5	2.42	36,0	--	0,380	0.838
20491-36-10TZ*	-36	M36X2	16	-10	83,0	3.27	49,0	1.93	12,0	0.47	56,5	2.22	41	--	0,290	0.639
20491-36-12TZ*	-36	M36X2	20	-12	93,8	3.69	55,3	2.18	15,0	0.59	56,0	2.20	41	--	0,422	0.930
20491-36-16WZ**	-36	M36X2	25	-16	118,0	4.65	71,0	2.80	21,0	0.83	68,5	2.70	41	--	0,450	0.992
20491-45-16TZ*	-45	M45X2	25	-16	118,0	4.65	71,0	2.80	21,0	0.83	69,5	2.74	50	--	0,660	1.455
20491-45-24WZ**	-45	M45X2	40	-24	169,5	6.67	101,5	4.00	32,0	1.26	91,5	3.60	50	--	0,900	1.984
20491-45-20TZ*	-45	M45X2	32	-20	135,5	5.33	81,5	3.21	27,0	1.06	78,5	3.09	50	--	0,850	1.874
20491-52-20TZ*	-52	M52X2	32	-20	137,0	5.39	83,0	3.27	27,0	1.06	81,0	3.19	60	--	0,913	2.013
20491-52-24TZ*	-52	M52X2	40	-24	177,5	6.99	109,4	4.31	32,0	1.26	100,5	3.96	60	--	1,470	3.241

* Denotes Style 1 design

** Denotes Style 2 wire nut design

DIN 24° HEAVY DUTY

DIN 24° Male Rigid (DKO Heavy)

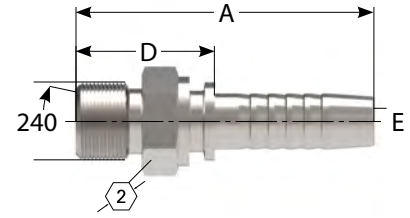

PART #	HOSE SIZE INFO			DIMENSIONS								WEIGHT		
	Terminal End	Thread	Hose Size	A		D Cut Off Factor		E Ø		1	2	kg	lb	
	Dash Size		DN	Dash Size	mm	in	mm	in	mm	in	mm	mm		
10511-14-04Z	-14	M14x1.5	6	-04	52,5	2.07	24,5	0.96	4,0	0.16	--	14	0,025	0.055
10511-16-04Z	-16	M16x1.5	6	-04	54,5	2.15	26,5	1.04	4,0	0.16	--	17	0,036	0.079
10511-18-04Z	-18	M18x1.5	6	-04	54,5	2.15	26,5	1.04	4,0	0.16	--	19	0,040	0.088
10511-18-06Z	-18	M18x1.5	10	-06	56,5	2.22	26,5	1.04	7,0	0.28	--	19	0,045	0.099
10511-20-05Z	-20	M20x1.5	8	-05	55,0	2.17	27,0	1.06	5,5	0.22	--	22	0,052	0.114
10511-20-06Z	-20	M20x1.5	10	-06	56,5	2.22	26,5	1.04	7,0	0.28	--	22	0,060	0.132
10511-22-06Z	-22	M22x1.5	10	-06	60,5	2.38	30,5	1.20	7,0	0.28	--	24	0,070	0.154
10511-22-08Z	-22	M22x1.5	12	-08	62,5	2.46	31,0	1.22	10,0	0.39	--	24	0,080	0.176
10511-24-08Z	-24	M24x1.5	12	-08	63,0	2.48	31,5	1.24	10,0	0.39	--	27	0,090	0.198
10511-30-10Z	-30	M30x2	16	-10	68,5	2.70	34,5	1.36	12,0	0.47	--	32	0,140	0.308
10511-30-12Z	-30	M30x2	20	-12	74,5	2.93	36,0	1.42	15,0	0.59	--	32	0,150	0.330
10511-36-12Z	-36	M36x2	20	-12	79,0	3.11	40,5	1.59	15,0	0.59	--	41	0,255	0.561
10511-36-16Z	-36	M36x2	25	-16	88,6	3.49	41,5	1.63	21,0	0.83	--	38	0,245	0.539
10511-42-16Z	-42	M42x2	25	-16	91,0	3.58	44,0	1.73	21,0	0.83	--	46	0,336	0.739

Two-piece fittings

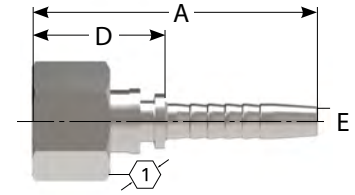

DIN 24° Female Swivel (DKO Heavy)

PART		HOSE SIZE INFO			DIMENSIONS							WEIGHT		
#	Terminal End	Thread	Hose Size	A	D Cut Off Factor		E Ø		1	2	Weight			
	Dash Size		DN	Dash Size	mm	in	mm	in	mm	in	mm	mm	kg	lb
20511-14-04WZ**	-14	M14X1.5	6	-04	51,0	2.01	23,0	0.91	4,0	0.16	17	--	0,030	0.066
20511-16-04TZ*	-16	M16X1.5	6	-04	48,5	1.91	20,5	0.81	4,0	0.16	19	--	0,026	0.057
20511-16-05WZ**	-16	M16X1.5	8	-05	51,0	2.01	23,0	0.91	5,5	0.22	19	--	0,047	0.104
20511-16-06WZ**	-16	M16X1.5	10	-06	53,0	2.09	23,0	0.91	7,0	0.28	19	--	0,045	0.099
20511-18-04TZ*	-18	M18X1.5	6	-04	53,5	2.11	25,5	1.00	4,0	0.16	22	--	0,053	0.117
20511-18-05TZ*	-18	M18X1.5	8	-05	53,5	2.11	25,5	1.00	5,5	0.22	22	--	0,051	0.112
20511-18-06TZ*	-18	M18X1.5	10	-06	56,0	2.20	26,0	1.02	7,0	0.28	22	--	0,054	0.119
20511-20-04TZ*	-20	M20X1.5	6	-04	54,5	2.15	26,5	1.04	4,0	0.16	24	--	0,060	0.132
20511-20-05TZ*	-20	M20X1.5	8	-05	54,5	2.15	26,5	1.04	5,5	0.22	24	--	0,065	0.143
20511-20-06TZ*	-20	M20X1.5	10	-06	56,5	2.22	26,5	1.04	7,0	0.28	24	--	0,065	0.143
20511-20-08WZ**	-20	M20X1.5	12	-08	57,0	2.24	25,5	1.00	10,0	0.39	24	--	0,076	0.168
20511-22-06TZ*	-22	M22X1.5	10	-06	56,5	2.22	26,5	1.04	7,0	0.28	27	--	0,090	0.198
20511-22-08TZ*	-22	M22X1.5	12	-08	59,0	2.32	27,5	1.08	10,0	0.39	27	--	0,088	0.194
20511-24-10WZ**	-24	M24X1.5	16	-10	60,5	2.38	26,5	1.04	12,0	0.47	30	--	0,126	0.278
20511-24-06TZ*	-24	M24X1.5	10	-06	57,0	2.24	27,0	1.06	7,0	0.28	30	--	0,100	0.220
20511-24-08TZ*	-24	M24X1.5	12	-08	59,0	2.32	27,5	1.08	10,0	0.39	30	--	0,106	0.234
20511-30-10TZ*	-30	M30X2	16	-10	67,0	2.64	33,0	1.30	12,0	0.47	36	--	0,180	0.397
20511-30-12TZ*	-30	M30X2	20	-12	73,5	2.89	35,0	1.38	15,0	0.59	36	--	0,195	0.430
20511-30-08TZ*	-30	M30X2	12	-08	64,0	2.52	32,5	1.28	10,0	0.39	36	--	0,170	0.375
20511-36-12TZ*	-36	M36X2	20	-12	73,5	2.89	35,0	1.38	15,0	0.59	46	--	0,300	0.661
20511-36-16WZ**	-36	M36X2	25	-16	78,5	3.09	31,5	1.24	21,0	0.83	46	--	0,330	0.728
20511-42-12TZ*	-42	M42X2	20	-12	76,0	2.99	37,5	1.48	15,0	0.59	50	--	0,362	0.798
20511-42-16TZ*	-42	M42X2	25	-16	85,5	3.37	38,5	1.52	21,0	0.83	50	--	0,370	0.816
20511-42-20WZ**	-42	M42X2	32	-20	85,5	3.37	31,5	1.24	27,0	1.06	50	--	0,404	0.891
20511-52-20TZ*	-52	M52X2	32	-20	95,5	3.76	41,5	1.63	27,0	1.06	60	--	0,626	1.380
20511-52-24TZ*	-52	M52X2	40	-24	109,5	4.31	41,5	1.63	32,0	1.26	60	--	0,700	1.543

* Denotes Style 1 design

** Denotes Style 2 wire nut design

Two-piece fittings

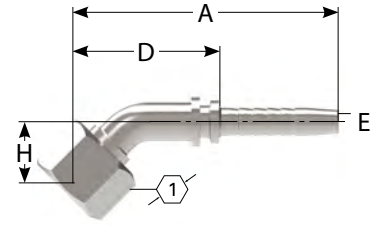

DIN 24° Female 45° Elbow (DKO Heavy)

PART		HOSE SIZE INFO			DIMENSIONS								WEIGHT			
#	Terminal End	Thread	Hose Size	A	D Cut Off Factor		E Ø		H	1	2	Weight				
	Dash Size		DN	Dash Size	mm	in	mm	in	mm	in	mm	mm	kg	lb		
20541-16-04TZ*	-16	M16X1.5	6	-04	66,4	2.61	38,4	1.51	4,0	0.16	16,3	0.64	19	--	0,045	0.099
20541-18-04TZ*	-18	M18X1.5	6	-04	67,1	2.64	39,1	1.54	4,0	0.16	17,0	0.67	22	--	0,058	0.128
20541-18-06TZ*	-18	M18X1.5	10	-06	73,8	2.91	43,8	1.72	7,0	0.28	17,3	0.68	22	--	0,062	0.137
20541-20-06TZ*	-20	M20X1.5	10	-06	72,5	2.85	42,5	1.67	7,0	0.28	18,5	0.73	24	--	0,085	0.187
20541-22-08TZ*	-22	M22X1.5	12	-08	81,1	3.19	49,6	1.95	10,0	0.39	20,7	0.81	27	--	0,118	0.260
20541-22-06TZ	-22	M22x1.5	10	-06	72,0	2.84	42,0	1.65	7,0	0.28	18,0	0.71	27	--	0,105	0.231
20541-24-06TZ*	-24	M24X1.5	10	-06	72,3	2.85	42,3	1.67	7,0	0.28	18,4	0.72	30	--	0,114	0.251
20541-24-08TZ*	-24	M24X1.5	12	-08	78,8	3.10	47,3	1.86	10,0	0.39	21,0	0.83	30	--	0,142	0.313
20541-30-10TZ*	-30	M30X2	16	-10	91,3	3.59	57,3	2.26	12,0	0.47	25,0	0.98	36	--	0,250	0.551
20541-30-12TZ*	-30	M30X2	20	-12	104,3	4.11	65,8	2.59	15,0	0.59	26,7	1.05	36	--	0,248	0.547
20541-36-12TZ*	-36	M36X2	20	-12	105,6	4.16	67,1	2.64	15,0	0.59	30,5	1.20	46	--	0,400	0.882
20541-36-16WZ**	-36	M36X2	25	-16	124,4	4.90	77,4	3.05	21,0	0.83	31,2	1.23	46	--	0,450	0.992
20541-42-16TZ*	-42	M42X2	25	-16	128,0	5.04	81,0	3.19	21,0	0.83	35,5	1.40	50	--	0,540	1.190
20541-52-20TZ*	-52	M52X2	32	-20	155,7	6.13	94,2	3.71	27,0	1.06	42,0	1.65	60	--	0,813	1.792
20541-52-24TZ*	-52	M52X2	40	-24	182,1	7.17	114,1	4.49	32,0	1.26	43,4	1.71	60	--	1,284	2.831

* Denotes Style 1 design

** Denotes Style 2 wire nut design

Two-piece fittings

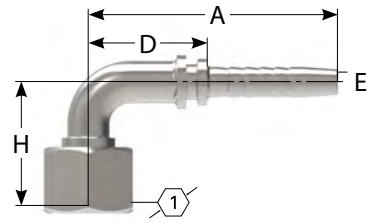

DIN 24° Female 90° Elbow (DKO Heavy)

PART		HOSE SIZE INFO			DIMENSIONS								WEIGHT		
#	Terminal End	Thread	Hose Size	A	D	D Cut Off Factor	E Ø	H	1	2	Weight				
	Dash Size	DN	Dash Size	mm	in	mm	in	mm	in	mm	mm	kg	lb		
20591-14-04WZ**	-14	M14X1.5	6 -04	58,0	2.28	30,0	1.18	4,0	0.16	30,5	1.20	17	--	0,045	0.099
20591-16-04TZ*	-16	M16X1.5	6 -04	58,0	2.28	30,0	1.18	4,0	0.16	31,0	1.22	19	--	0,040	0.088
20591-16-05WZ**	-16	M16X1.5	8 -05	58,0	2.28	30,0	1.18	5,5	0.22	31,0	1.22	19	--	0,050	0.110
20591-16-06WZ**	-16	M16X1.5	10 -06	60,0	2.36	30,0	1.18	7,0	0.28	31,0	1.22	19	--	0,059	0.130
20591-18-04TZ*	-18	M18X1.5	6 -04	58,0	2.28	30,0	1.18	4,0	0.16	32,0	1.26	22	--	0,065	0.144
20591-18-05TZ*	-18	M18X1.5	8 -05	61,0	2.40	33,0	1.30	5,5	0.22	33,5	1.32	22	--	0,050	0.110
20591-18-06TZ*	-18	M18X1.5	10 -06	67,0	2.64	37,0	1.46	7,0	0.28	35,0	1.38	22	--	0,078	0.172
20591-20-05TZ*	-20	M20X1.5	8 -05	61,0	2.40	33,0	1.30	5,5	0.22	34,0	1.34	24	--	0,080	0.176
20591-20-06TZ*	-20	M20X1.5	10 -06	64,5	2.54	34,5	1.36	7,0	0.28	35,5	1.40	24	--	0,094	0.207
20591-20-08WZ**	-20	M20X1.5	12 -08	69,5	2.74	38,0	1.50	10,0	0.39	38,0	1.50	24	--	0,098	0.216
20591-22-06TZ*	-22	M22X1.5	10 -06	64,5	2.54	34,5	1.36	7,0	0.28	36,0	1.42	27	--	0,114	0.251
20591-22-08TZ*	-22	M22X1.5	12 -08	73,5	2.89	42,0	1.65	10,0	0.39	42,5	1.67	27	--	0,136	0.300
20591-24-06TZ*	-24	M24X1.5	10 -06	64,5	2.54	34,5	1.36	7,0	0.28	36,5	1.44	30	--	0,125	0.276
20591-24-08TZ*	-24	M24X1.5	12 -08	71,0	2.80	39,5	1.56	10,0	0.39	43,0	1.69	30	--	0,136	0.300
20591-30-08TZ*	-30	M30X2	12 -08	76,0	2.99	44,5	1.75	10,0	0.39	46,0	1.81	36	--	0,196	0.432
20591-30-10TZ*	-30	M30X2	16 -10	83,0	3.27	49,0	1.93	12,0	0.47	49,5	1.95	36	--	0,265	0.584
20591-30-12TZ*	-30	M30X2	20 -12	94,3	3.71	55,8	2.20	15,0	0.59	54,5	2.15	36	--	0,265	0.584
20591-36-12TZ*	-36	M36X2	20 -12	94,5	3.72	56,0	2.20	15,0	0.59	59,0	2.32	46	--	0,482	1.063
20591-36-16WZ**	-36	M36X2	25 -16	112,5	4.43	65,5	2.58	21,0	0.83	63,5	2.50	46	--	0,500	1.102
20591-42-16TZ*	-42	M42X2	25 -16	118,0	4.65	71,0	2.80	21,0	0.83	70,0	2.76	50	--	0,610	1.345
20591-52-20TZ*	-52	M52X2	32 -20	147,0	5.79	93,0	3.66	27,0	1.06	86,5	3.41	60	--	0,945	2.083
20591-52-24TZ*	-52	M52X2	40 -24	168,0	6.61	100,0	3.94	32,0	1.26	109,4	4.31	60	--	1,630	3.594

* Denotes Style 1 design

** Denotes Style 2 wire nut design

Code 61

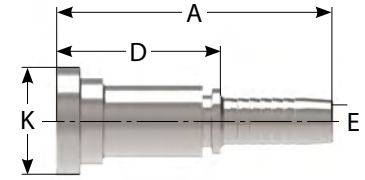

Code 61 Flange Straight

PART		HOSE SIZE INFO				DIMENSIONS						WEIGHT	
#	Terminal End	K		Hose Size		A		D Cut Off Factor		E Ø		Weight	
	Dash Size	mm	in	DN	Dash Size	mm	in	mm	in	mm	in	kg	lb
87311-08-08Z	-08	30.2	1.19	12	-08	77,5	3.05	46,0	1.81	10,0	0.39	0,11	0.24
87311-12-08Z	-12	38,1	1.50	12	-08	78,5	3.09	47,0	1.85	10,0	0.39	0,165	0.364
87311-12-10Z	-12	38.1	1.50	16	-10	81,5	3.21	47,5	1.87	12,0	0.47	0,20	0.44
87311-12-12Z	-12	38.1	1.50	20	-12	86,5	3.41	48,0	1.89	15,0	0.59	0,21	0.46
87311-12-16Z	-12	38.1	1.50	25	-16	96,0	3.78	49,0	1.93	21,0	0.83	0,26	0.58
87311-16-12Z	-16	44.4	1.75	20	-12	89,5	3.52	51,0	2.01	15,0	0.59	0,24	0.52
87311-16-16Z	-16	44.4	1.75	25	-16	99,0	3.90	52,0	2.05	21,0	0.83	0,30	0.65
87311-16-20Z	-16	44.4	1.75	32	-20	107,0	4.21	53,0	2.09	27,0	1.06	0,37	0.81
87311-20-16Z	-20	50.8	2.00	25	-16	104,0	4.09	57,0	2.24	21,0	0.83	0,35	0.78
87311-20-20Z	-20	50.8	2.00	32	-20	112,0	4.41	58,0	2.28	27,0	1.06	0,44	0.97
87311-20-24Z	-20	50.8	2.00	40	-24	129,0	5.08	61,0	2.40	32,0	1.26	0,51	1.11
87311-24-20Z	-24	60.3	2.37	32	-20	122,0	4.80	68,0	2.68	27,0	1.06	0,60	1.32
87311-24-24Z	-24	60.3	2.37	40	-24	136,0	5.35	68,0	2.68	32,0	1.26	0,68	1.50
87311-32-20Z	-32	71.4	2.81	32	-20	124,0	4.88	70,0	2.76	27,0	1.06	0,65	1.43
87311-32-24Z	-32	71.4	2.81	40	-24	138,0	5.43	70,0	2.76	32,0	1.26	0,81	1.78
87311-32-32Z	-32	71.4	2.81	50	-32	142,0	5.59	70,0	2.76	43,0	1.69	1,04	2.29

Two-piece fittings

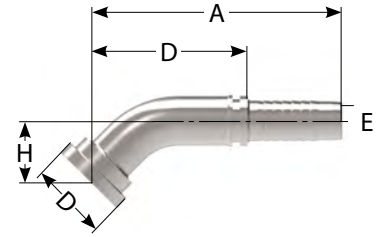

Code 61 Flange 45° Elbow

PART		HOSE SIZE INFO				DIMENSIONS								WEIGHT	
#	Terminal End	K	Hose Size		A		D Cut Off Factor		E Ø		H		Weight		
	Dash Size	mm	in	DN	Dash Size	mm	in	mm	in	mm	in	mm	in	kg	lb
87341-08-08Z	-08	30.2	1.19	12	-08	83,4	3.28	58,2	2.29	10,0	0.39	23,3	0.92	0,11	0.24
87341-12-08Z	-12	38,1	1.50	12	-08	90,4	3.56	58,9	2.32	10,0	0.39	24,0	0.94	0,152	0.0335
87341-12-12Z	-12	38.1	1.50	20	-12	108,4	4.27	76,3	3.00	15,0	0.59	28,9	1.14	0,27	0.58
87341-12-16Z	-12	38.1	1.50	25	-16	115,8	4.56	84,7	3.33	21,0	0.83	29,7	1.17	0,33	0.73
87341-16-12Z	-16	44.4	1.75	20	-12	114,7	4.52	76,3	3.00	15,0	0.59	28,9	1.14	0,30	0.65
87341-16-16Z	-16	44.4	1.75	25	-16	121,3	4.78	83,9	3.30	21,0	0.83	29,7	1.17	0,36	0.79
87341-16-20Z	-16	44.4	1.75	32	-20	130,9	5.15	94,5	3.72	27,0	1.06	33,8	1.33	0,47	1.03
87341-20-16Z	-20	50.8	2.00	25	-16	129,0	5.08	85,2	3.35	21,0	0.83	29,7	1.17	0,40	0.87
87341-20-20Z	-20	50.8	2.00	32	-20	137,3	5.41	94,5	3.72	27,0	1.06	33,8	1.33	0,51	1.12
87341-20-24Z	-20	50.8	2.00	38	-24	145,8	5.74	103,0	4.06	32,0	1.26	33,8	1.33	0,66	1.46
87341-24-20Z	-24	60.3	2.37	32	-20	148,2	5.83	95,9	3.78	27,0	1.06	35,2	1.39	0,58	1.28
87341-24-24Z	-24	60.3	2.37	38	-24	162,2	6.39	109,9	4.33	32,0	1.26	39,1	1.54	0,95	2.09
87341-24-32Z	-24	60.3	2.37	50	-32	180,9	7.12	128,6	5.06	43,0	1.69	41,3	1.63	1,22	2.69
87341-32-24Z	-32	71.4	2.81	38	-24	173,3	6.82	109,9	4.33	32,0	1.26	39,1	1.54	1,05	2.31
87341-32-32Z	-32	71.4	2.81	50	-32	192,7	7.59	129,3	5.09	46,0	1.81	46,3	1.82	1,54	3.39

Two-piece fittings

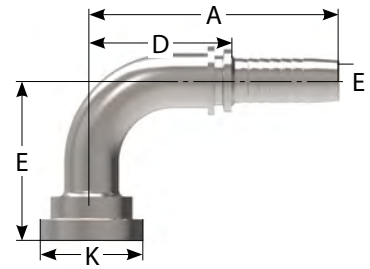

Code 61 Flange 90° Elbow

PART		HOSE SIZE INFO				DIMENSIONS								WEIGHT	
#	Terminal End	K		Hose Size	A		D Cut Off Factor		E Ø		H		Weight		
	Dash Size	mm	in	DN	Dash Size	mm	in	mm	in	mm	in	mm	in	kg	lb
87391-08-08Z	-08	30.2	1.19	12	-08	72,5	2.85	41,0	1.61	10,0	0.39	47,0	1.85	0,122	0.268
87391-12-08Z	-12	38,1	1.50	12	-08	72,5	2.85	41,0	1.61	10,0	0.39	48,0	1.89	0,164	0.361
87391-12-10Z	-12	38.1	1.50	16	-10	90,0	3.54	56,0	2.20	12,0	0.47	52,5	2.07	0,220	0.484
87391-12-12Z	-12	38.1	1.50	20	-12	104,7	4.12	66,2	2.61	15,0	0.59	62,0	2.44	0,320	0.704
87391-12-16Z	-12	38.1	1.50	25	-16	123,7	4.87	76,7	3.02	21,0	0.83	67,5	2.66	0,384	0.845
87391-16-12Z	-16	44.4	1.75	20	-12	104,0	4.09	65,5	2.58	15,0	0.59	62,0	2.44	0,370	0.814
87391-16-16Z	-16	44.4	1.75	25	-16	123,7	4.87	76,7	3.02	21,0	0.83	67,5	2.66	0,425	0.935
87391-16-20Z	-16	44.4	1.75	32	-20	145,5	5.73	91,5	3.60	27,0	1.06	78,5	3.09	0,592	1.302
87391-20-12Z	-20	50.8	2.00	20	-12	104,7	4.12	66,2	2.61	15,0	0.59	62,0	2.44	0,388	0.853
87391-20-16Z	-20	50.8	2.00	25	-16	123,7	4.87	76,7	3.02	21,0	0.83	67,5	2.66	0,460	1.012
87391-20-20Z	-20	50.8	2.00	32	-20	145,5	5.73	91,5	3.60	27,0	1.06	78,5	3.09	0,636	1.399
87391-20-24Z	-20	50.8	2.00	40	-24	175,0	6.89	107,0	4.21	32,0	1.26	78,5	3.09	0,902	1.984
87391-24-16Z	-24	60.3	2.37	25	-16	123,7	4.87	76,7	3.02	21,0	0.83	69,5	2.74	0,538	1.184
87391-24-20Z	-24	60.3	2.37	32	-20	145,5	5.73	91,5	3.60	27,0	1.06	80,5	3.17	0,700	1.540
87391-24-24Z	-24	60.3	2.37	40	-24	177,4	6.98	109,4	4.31	32,0	1.26	94,0	3.70	1,212	2.666
87391-32-24Z	-32	71.4	2.81	40	-24	177,4	6.98	109,4	4.31	32,0	1.26	94,0	3.70	1,344	2.957
87391-32-32Z	-32	71.4	2.81	50	-32	203,8	8.02	131,8	5.19	43,0	1.69	114,3	4.50	2,200	4.840

JIC

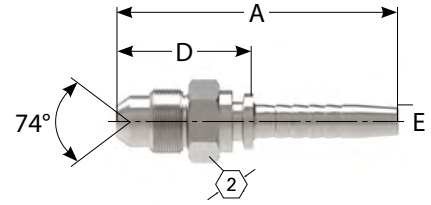

JIC 37° Male Rigid

PART #	HOSE SIZE INFO			DIMENSIONS								WEIGHT		
	Terminal End	Thread	Hose Size	A		D Cut Off Factor		E Ø		1	2	kg	lb	
	Dash Size		DN	Dash Size	mm	in	mm	in	mm	in	mm	mm		
16711-04-04Z	-04	7/16"-20	6	-04	54,5	2.15	26,5	1.04	4,0	0.16	--	12	0,024	0.053
16711-04-08Z	-04	7/16"-20	12	-08	58,5	2.30	27,0	1.06	10,0	0.39	--	19	0,045	0.099
16711-05-04Z	-05	1/2"-20	6	-04	54,5	2.15	26,5	1.04	4,0	0.16	--	14	0,024	0.053
16711-05-05Z	-05	1/2"-20	8	-05	54,5	2.15	26,5	1.04	5,5	0.22	--	14	0,025	0.055
16711-05-06Z	-05	1/2"-20	10	-06	56,5	2.22	26,5	1.04	7,0	0.28	--	17	0,032	0.071
16711-06-04Z	-06	9/16"-18	6	-04	54,5	2.15	26,5	1.04	4,0	0.16	--	17	0,030	0.066
16711-06-05Z	-06	9/16"-18	8	-05	54,5	2.15	26,5	1.04	5,5	0.22	--	17	0,030	0.066
16711-06-06Z	-06	9/16"-18	10	-06	56,5	2.22	26,5	1.04	7,0	0.28	--	17	0,034	0.075
16711-06-08Z	-06	9/16"-18	12	-08	58,5	2.30	27,0	1.06	10,0	0.39	--	19	0,046	0.101
16711-08-04Z	-08	3/4"-16	6	-04	59,5	2.34	26,7	1.05	4,0	0.16	--	19	0,045	0.099
16711-08-06Z	-08	3/4"-16	10	-06	61,5	2.42	31,5	1.24	7,0	0.28	--	22	0,062	0.137
16711-08-08Z	-08	3/4"-16	12	-08	63,5	2.50	32,0	1.26	9,9	0.39	--	22	0,064	0.141
16711-10-06Z	-10	7/8"-14	10	-06	63,5	2.50	33,5	1.32	7,0	0.28	--	24	0,070	0.154
16711-10-08Z	-10	7/8"-14	12	-08	65,5	2.58	34,0	1.34	10,0	0.39	--	24	0,084	0.185
16711-10-10Z	-10	7/8"-14	16	-10	69,0	2.72	35,0	1.38	12,0	0.47	--	24	0,092	0.203
16711-10-12Z	-10	7/8"-14	20	-12	75,5	2.97	37,0	1.46	15,0	0.59	--	27	0,130	0.287
16711-12-08Z	-12	1.1/16"-12	12	-08	70,0	2.76	38,5	1.52	10,0	0.39	--	30	0,116	0.256
16711-12-10Z	-12	1.1/16"-12	16	-10	73,5	2.89	39,5	1.56	12,0	0.47	--	30	0,120	0.265
16711-12-12Z	-12	1.1/16"-12	20	-12	78,5	3.09	40,0	1.57	15,0	0.59	--	30	0,140	0.309
16711-12-16Z	-12	1.1/16"-12	25	-16	89,5	3.52	42,5	1.67	21,0	0.83	--	32	0,198	0.437
16711-14-12Z	-14	1.3/16"-12	20	-12	79,0	3.11	40,5	1.59	15,0	0.59	--	32	0,162	0.357
16711-16-12Z	-16	1.5/16"-12	20	-12	81,5	3.21	43,0	1.69	15,0	0.59	--	36	0,190	0.419
16711-16-16Z	-16	1.5/16"-12	25	-16	90,5	3.56	43,5	1.71	21,0	0.83	--	36	0,206	0.454
16711-20-16Z	-20	1.5/8"-12	25	-16	94,0	3.70	47,0	1.85	21,0	0.83	--	46	0,336	0.741
16711-20-20Z	-20	1.5/8"-12	32	-20	101,0	3.98	47,0	1.85	27,0	1.06	--	46	0,370	0.816
16711-24-20Z	-24	1.7/8"-12	32	-20	107,0	4.21	53,0	2.09	27,0	1.06	--	50	0,495	1.091
16711-24-24Z	-24	1.7/8"-12	38	-24	121,0	4.76	53,0	2.09	32,0	1.26	--	50	0,542	1.195
16711-32-32Z	-32	2.1/2"-12	50	-32	134,0	5.28	62,0	2.44	43,0	1.69	--	65	1,060	2.337

Two-piece fittings

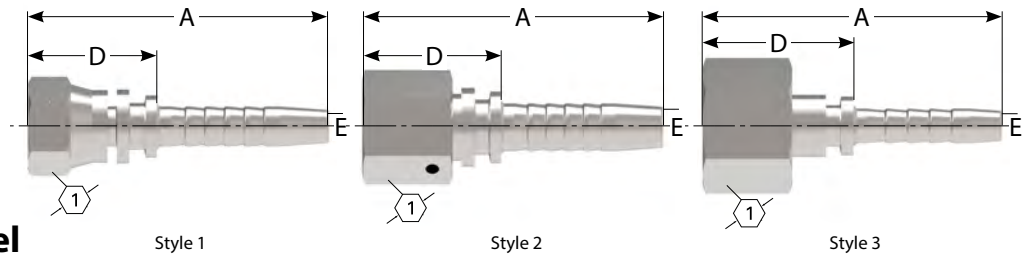

JIC 37° Female Swivel

PART		HOSE SIZE INFO			DIMENSIONS							WEIGHT		
#	Terminal End	Thread	Hose Size	A	D Cut Off Factor		E Ø		1	2	Weight			
	Dash Size	DN	Dash Size	mm	in	mm	in	mm	in	mm	mm	kg	lb	
26711-04-03Z*	-04	7/16"-20	5	-03	35,5	1.40	14,0	0.55	3,0	0.12	14	--	0,015	0.033
26711-04-04Z*	-04	7/16"-20	6	-04	43,0	1.69	15,0	0.59	4,0	0.16	14	--	0,020	0.044
26711-04-05Z*	-04	7/16"-20	8	-05	43,0	1.69	15,0	0.59	5,5	0.22	14	--	0,022	0.049
26711-04-06Z*	-04	7/16"-20	10	-06	44,5	1.75	14,5	0.57	7,0	0.28	14	--	0,028	0.062
26711-05-04Z*	-05	1/2"-20	6	-04	43,5	1.71	15,5	0.61	4,0	0.16	17	--	0,026	0.057
26711-05-05Z*	-05	1/2"-20	8	-05	43,5	1.71	15,5	0.61	5,5	0.22	17	--	0,025	0.055
26711-05-06Z*	-05	1/2"-20	10	-06	45,5	1.79	15,5	0.61	7,0	0.28	17	--	0,032	0.071
26711-06-04Z*	-06	9/16"-18	6	-04	43,5	1.71	15,5	0.61	4,0	0.16	19	--	0,032	0.071
26711-06-05Z*	-06	9/16"-18	8	-05	43,5	1.71	15,5	0.61	5,5	0.22	19	--	0,035	0.077
26711-06-06Z*	-06	9/16"-18	10	-06	45,5	1.79	15,5	0.61	7,0	0.28	19	--	0,037	0.082
26711-06-08Z*	-06	9/16"-18	12	-08	47,5	1.87	16,0	0.63	10,0	0.39	19	--	0,046	0.101
26711-08-04TZ***	-08	3/4"-16	6	-04	43,5	1.71	15,5	0.61	4,0	0.16	24	--	0,054	0.119
26711-08-06Z*	-08	3/4"-16	10	-06	47,5	1.87	17,5	0.69	7,0	0.28	22	--	0,054	0.119
26711-08-08Z*	-08	3/4"-16	12	-08	50,0	1.97	18,5	0.73	9,9	0.39	22	--	0,060	0.132
26711-08-10Z*	-08	3/4"-16	16	-10	52,0	2.05	18,0	0.71	12,0	0.47	22	--	0,078	0.172
26711-08-12Z*	-08	3/4"-16	20	-12	58,0	2.28	19,5	0.77	15,0	0.59	22	--	0,078	0.172
26711-10-06TZ***	-10	7/8"-14	10	-06	47,5	1.87	17,5	0.69	7,0	0.28	27	--	0,080	0.176
26711-10-08Z*	-10	7/8"-14	12	-08	50,5	1.99	19,0	0.75	10,0	0.39	27	--	0,090	0.198
26711-10-10Z*	-10	7/8"-14	16	-10	53,5	2.11	19,5	0.77	12,0	0.47	27	--	0,100	0.220
26711-10-12Z*	-10	7/8"-14	20	-12	58,5	2.30	20,0	0.79	15,0	0.59	27	--	0,110	0.243
26711-12-08TZ***	-12	1.1/16"-12	12	-08	51,0	2.01	19,5	0.77	10,0	0.39	32	--	0,128	0.282
26711-12-10Z*	-12	1.1/16"-12	16	-10	55,0	2.17	21,0	0.83	12,0	0.47	32	--	0,120	0.265
26711-12-12Z*	-12	1.1/16"-12	20	-12	60,0	2.36	21,5	0.85	15,0	0.59	32	--	0,130	0.287
26711-12-16Z*	-12	1.1/16"-12	25	-16	70,0	2.76	23,0	0.91	21,0	0.83	32	--	0,172	0.379
26711-14-12Z*	-14	1.3/16"-12	20	-12	60,0	2.36	21,5	0.85	15,0	0.59	36	--	0,154	0.340
26711-14-16Z*	-14	1.3/16"-12	25	-16	69,5	2.74	22,5	0.89	21,0	0.83	36	--	0,170	0.375
26711-16-12TZ***	-16	1.5/16"-12	20	-12	57,0	2.24	18,5	0.73	15,0	0.59	41	--	0,215	0.474
26711-16-16Z*	-16	1.5/16"-12	25	-16	70,0	2.76	23,0	0.91	21,0	0.83	41	--	0,210	0.463
26711-16-20Z*	-16	1.5/16"-12	32	-20	78,0	3.07	24,0	0.94	27,0	1.06	41	--	0,306	0.675
26711-20-16TZ***	-20	1.5/8"-12	25	-16	70,0	2.76	23,0	0.91	21,0	0.83	50	--	0,340	0.750
26711-20-20WZ**	-20	1.5/8"-12	32	-20	78,5	3.09	24,5	0.96	27,0	1.06	50	--	0,400	0.882
26711-24-20TZ***	-24	1.7/8"-12	32	-20	79,0	3.11	25,0	0.98	27,0	1.06	60	--	0,490	1.080
26711-24-24WZ**	-24	1.7/8"-12	38	-24	94,5	3.72	26,5	1.04	32,0	1.26	60	--	0,568	1.252
26711-32-24TZ***	-32	2.1/2"-12	38	-24	95,0	3.74	27,0	1.06	32,0	1.26	75	--	0,920	2.028
26711-32-32TZ***	-32	2.1/2"-12	50	-32	99,0	3.90	27,0	1.06	43,0	1.69	75	--	1,072	2.363

* Denotes Style 1 design

** Denotes Style 2 wire nut design

*** Denotes Style 3 crimp nut design

1. Same nipple configuration as 26711 without back up hex

Two-piece fittings

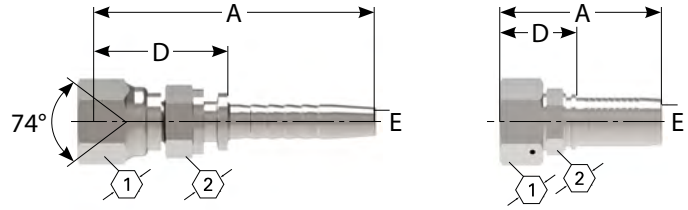

JIC 37° Female Swivel

PART #	HOSE SIZE INFO			DIMENSIONS								WEIGHT		
	Terminal End	Thread	Hose Size	A		D Cut Off Factor		E Ø		1	2	Weight		
	Dash Size		DN	Dash Size	mm	in	mm	in	mm	in	mm	mm	kg	lb
26711D-04-04Z*	-04	7/16"-20	6	-04	48,0	1.89	20,0	0.79	4,0	0.16	14	14	0,040	0.088
26711D-04-04SMZ*	-04	7/16"-20	6	-04	48,0	1.89	20,0	0.79	4,0	0.16	14	12	0,040	0.088
26711D-06-04Z*	-06	9/16"-18	6	-04	49,0	1.93	21,0	0.83	4,0	0.16	19	19	0,044	0.097
26711D-06-04SMZ*	-06	9/16"-18	6	-04	49,0	1.93	21,0	0.83	4,0	0.16	19	14	0,045	0.099
26711D-06-05Z*	-06	9/16"-18	8	-05	49,0	1.93	21,0	0.83	5,5	0.22	19	19	0,046	0.101
26711D-06-06Z*	-06	9/16"-18	10	-06	51,0	2.01	21,0	0.83	7,0	0.28	19	19	0,045	0.099
26711D-06-06SMZ*	-06	9/16"-18	10	-06	51,0	2.01	21,0	0.83	7,0	0.28	19	17	0,045	0.099
26711D-08-04Z*	-08	3/4"-16	6	-04	53,0	2.09	25,0	0.98	4,0	0.16	22	24	0,075	0.165
26711D-08-06Z*	-08	3/4"-16	10	-06	55,0	2.17	25,0	0.98	7,0	0.28	22	24	0,081	0.179
26711D-08-06SMZ*	-08	3/4"-16	10	-06	54,5	2.15	24,5	0.96	7,0	0.28	22	19	0,085	0.187
26711D-08-08Z*	-08	3/4"-16	12	-08	56,0	2.20	24,5	0.96	9,9	0.39	22	24	0,080	0.176
26711D-08-08SMZ*	-08	3/4"-16	12	-08	55,0	2.17	23,5	0.93	9,9	0.39	22	19	0,085	0.187
26711D-10-08Z*	-10	7/8"-14	12	-08	57,5	2.26	26,0	1.02	10,0	0.39	27	27	0,108	0.238
26711D-10-08SMZ*	-10	7/8"-14	12	-08	57,5	2.26	26,0	1.02	10,0	0.39	27	22	0,104	0.229
26711D-10-10Z*	-10	7/8"-14	16	-10	61,0	2.40	27,0	1.06	12,0	0.47	27	27	0,120	0.265
26711D-10-10SMZ*	-10	7/8"-14	16	-10	61,0	2.40	27,0	1.06	12,0	0.47	27	22	0,104	0.229
26711D-12-08SMZ*	-12	1.1/16"-12	12	-08	61,0	2.40	29,5	1.16	10,0	0.39	32	27	0,166	0.366
26711D-12-10Z*	-12	1.1/16"-12	16	-10	65,0	2.56	31,0	1.22	12,0	0.47	32	32	0,180	0.397
26711D-12-12Z*	-12	1.1/16"-12	20	-12	70,0	2.76	31,5	1.24	15,0	0.59	32	32	0,188	0.414
26711D-12-12SMZ*	-12	1.1/16"-12	20	-12	70,0	2.76	31,5	1.24	15,0	0.59	32	27	0,166	0.366
26711D-16-16Z*	-16	1.5/16"-12	25	-16	81,5	3.21	34,5	1.36	21,0	0.83	41	41	0,320	0.705
26711D-16-16SMWZ**	-16	1.5/16"-12	25	-16	84,5	3.33	37,5	1.48	21,0	0.83	41	32	0,312	0.688
26711D-20-20SMWZ**	-20	1.5/8"-12	32	-20	95,0	3.74	41,0	1.61	27,0	1.06	50	41	0,502	1.107
26711D-32-32SMWZ**	-32	2.1/2"-12	50	-32	117,0	4.61	45,0	1.77	43,0	1.69	75	65	1,380	3.042
26711D-24-24SMWZ**	-24	1.7/8"-12	38	-24	110,0	4.33	42,0	1.65	32,0	1.26	60	46	0,665	1.466

* Denotes Style 1 design

** Denotes Style 2 wire nut design

1. Same nipple configuration as 26711 with back up hex

Two-piece fittings

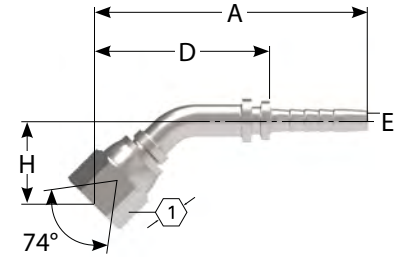

JIC 37° Female 45° Elbow

PART		HOSE SIZE INFO			DIMENSIONS								WEIGHT		
#	Terminal End	Thread	Hose Size	A	D Cut Off Factor		E Ø		H		1	2	kg	lb	
	Dash Size	DN	Dash Size	mm	in	mm	in	mm	in	mm	in	mm	mm		
26741-04-03Z*	-04	7/16"-20	5 -03	54,0	2.13	32,5	1.28	3,0	0.12	12,1	0.48	14	--	0,029	0.064
26741-04-04Z*	-04	7/16"-20	6 -04	63,1	2.48	35,1	1.38	4,0	0.16	13,0	0.51	14	--	0,035	0.077
26741-04-06Z*	-04	7/16"-20	10 -06	65,2	2.57	35,2	1.39	7,0	0.28	13,1	0.52	14	--	0,036	0.079
26741-05-04Z*	-05	1/2"-20	6 -04	63,6	2.50	35,6	1.40	4,0	0.16	13,5	0.53	17	--	0,038	0.084
26741-05-05Z*	-05	1/2"-20	8 -05	65,7	2.59	37,7	1.48	5,5	0.22	14,4	0.57	17	--	0,050	0.110
26741-06-04Z*	-06	9/16"-18	6 -04	63,6	2.50	35,6	1.40	4,0	0.16	13,5	0.53	19	--	0,045	0.099
26741-06-05Z*	-06	9/16"-18	8 -05	65,7	2.59	37,7	1.48	5,5	0.22	14,4	0.57	19	--	0,056	0.123
26741-06-06Z*	-06	9/16"-18	10 -06	68,8	2.71	38,8	1.53	7,0	0.28	14,8	0.58	19	--	0,062	0.137
26741-06-08Z*	-06	9/16"-18	12 -08	70,8	2.79	39,3	1.55	10,0	0.39	14,8	0.58	19	--	0,064	0.141
26741-06-10Z*	-06	9/16"-18	16 -10	75,8	2.98	41,8	1.65	12,0	0.47	14,8	0.58	19	--	0,068	0.150
26741-08-06Z*	-08	3/4"-16	10 -06	70,2	2.76	40,2	1.58	7,0	0.28	16,2	0.64	22	--	0,080	0.176
26741-08-08Z*	-08	3/4"-16	12 -08	76,8	3.02	45,3	1.78	10,0	0.39	19,0	0.75	22	--	0,105	0.231
26741-08-10Z*	-08	3/4"-16	16 -10	87,7	3.45	53,7	2.11	12,0	0.47	21,4	0.84	22	--	0,120	0.265
26741-10-06Z*	-10	7/8"-14	10 -06	71,6	2.82	41,6	1.64	7,0	0.28	17,6	0.69	27	--	0,092	0.203
26741-10-08Z*	-10	7/8"-14	12 -08	78,2	3.08	46,7	1.84	10,0	0.39	20,4	0.80	27	--	0,120	0.265
26741-10-10Z*	-10	7/8"-14	16 -10	88,4	3.48	54,4	2.14	12,0	0.47	22,1	0.87	27	--	0,146	0.322
26741-10-12Z*	-10	7/8"-14	20 -12	98,4	3.87	58,9	2.32	15,0	0.59	22,1	0.87	27	--	0,170	0.375
26741-12-08Z*	-12	1.1/16"-12	12 -08	81,9	3.22	50,4	1.98	10,0	0.39	21,1	0.83	32	--	0,140	0.309
26741-12-10Z*	-12	1.1/16"-12	16 -10	89,1	3.51	55,1	2.17	12,0	0.47	22,8	0.90	32	--	0,202	0.445
26741-12-12Z*	-12	1.1/16"-12	20 -12	97,8	3.85	59,3	2.33	15,0	0.59	24,2	0.95	32	--	0,240	0.529
26741-12-16Z*	-12	1.1/16"-12	25 -16	117,3	4.62	70,3	2.77	21,0	0.83	24,2	0.95	32	--	0,278	0.613
26741-14-12Z*	-14	1.3/16"-12	20 -12	98,6	3.88	60,1	2.37	15,0	0.59	24,2	0.95	36	--	0,230	0.507
26741-16-12Z*	-16	1.5/16"-12	20 -12	99,4	3.91	60,9	2.40	15,0	0.59	25,0	0.98	41	--	0,346	0.763
26741-16-16Z*	-16	1.5/16"-12	25 -16	121,3	4.78	74,3	2.93	21,0	0.83	28,7	1.13	41	--	0,400	0.882
26741-20-16WZ**	-20	1.5/8"-12	25 -16	123,6	4.87	76,6	3.02	21,0	0.83	31,1	1.22	50	--	0,536	1.182
26741-20-20WZ**	-20	1.5/8"-12	32 -20	150,3	5.92	96,3	3.79	27,0	1.06	35,5	1.40	50	--	0,650	1.433
26741-24-20WZ**	-24	1.7/8"-12	32 -20	140,6	5.54	86,6	3.41	27,0	1.06	35,9	1.41	60	--	0,780	1.720
26741-24-24WZ**	-24	1.7/8"-12	38 -24	182,8	7.20	114,8	4.52	32,0	1.26	44,1	1.74	60	--	1,122	2.474
26741-32-32WZ**	-32	2.1/2"-12	50 -32	207,9	8.19	135,9	5.35	43,0	1.69	51,6	2.03	75	--	2,076	4.577

* Denotes Style 1 design

** Denotes Style 2 wire nut design

Two-piece fittings

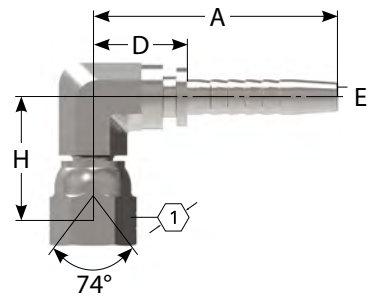

JIC 37° Female 90° Elbow

PART		HOSE SIZE INFO			DIMENSIONS								WEIGHT		
#	Terminal End	Thread	Hose Size	A	D Cut Off Factor		E Ø		H	1	2	Weight			
	Dash Size	DN	Dash Size	mm	in	mm	in	mm	in	mm	in	mm	mm	kg	lb
26791-04-03Z*	-04	7/16"-20	5 -03	48,0	1.89	26,5	1.04	3,0	0.12	23,3	0.92	14	--	0,024	0.053
26791-04-04Z*	-04	7/16"-20	6 -04	58,0	2.28	30,0	1.18	4,0	0.16	26,3	1.04	14	--	0,040	0.088
26791-04-05Z*	-04	7/16"-20	8 -05	58,0	2.28	30,0	1.18	5,5	0.22	26,3	1.04	14	--	0,040	0.088
26791-04-06Z*	-04	7/16"-20	10 -06	60,0	2.36	30,0	1.18	7,0	0.28	26,3	1.04	14	--	0,040	0.088
26791-05-04Z*	-05	1/2"-20	6 -04	58,0	2.28	30,0	1.18	4,0	0.16	27,0	1.06	17	--	0,042	0.093
26791-05-05Z*	-05	1/2"-20	8 -05	61,0	2.40	33,0	1.30	5,5	0.22	30,0	1.18	17	--	0,050	0.110
26791-05-06Z*	-05	1/2"-20	10 -06	63,0	2.48	33,0	1.30	7,0	0.28	30,0	1.18	17	--	0,055	0.121
26791-06-04Z*	-06	9/16"-18	6 -04	58,0	2.28	30,0	1.18	4,0	0.16	27,0	1.06	19	--	0,048	0.106
26791-06-05Z*	-06	9/16"-18	8 -05	61,0	2.40	33,0	1.30	5,5	0.22	30,0	1.18	19	--	0,062	0.137
26791-06-06Z*	-06	9/16"-18	10 -06	64,5	2.54	34,5	1.36	7,0	0.28	31,5	1.24	19	--	0,070	0.154
26791-06-08Z*	-06	9/16"-18	12 -08	69,5	2.74	38,0	1.50	10,0	0.39	31,5	1.24	19	--	0,070	0.154
26791-08-04Z*	-08	3/4"-16	6 -04	58,0	2.28	30,0	1.18	4,0	0.16	29,0	1.14	22	--	0,063	0.139
26791-08-06Z*	-08	3/4"-16	10 -06	64,5	2.54	34,5	1.36	7,0	0.28	33,5	1.32	22	--	0,088	0.194
26791-08-08Z*	-08	3/4"-16	12 -08	71,0	2.80	39,5	1.56	10,0	0.39	40,0	1.57	22	--	0,118	0.260
26791-08-10Z*	-08	3/4"-16	16 -10	81,5	3.21	45,5	1.79	12,0	0.47	40,0	1.57	22	--	0,124	0.273
26791-08-12Z*	-08	3/4"-16	20 -12	86,5	3.41	48,0	1.89	15,0	0.59	40,0	1.57	22	--	0,134	0.295
26791-10-06Z*	-10	7/8"-14	10 -06	66,5	2.62	36,5	1.44	7,0	0.28	34,5	1.36	27	--	0,100	0.220
26791-10-08Z*	-10	7/8"-14	12 -08	71,0	2.80	39,5	1.56	10,0	0.39	42,0	1.65	27	--	0,132	0.291
26791-10-10Z*	-10	7/8"-14	16 -10	83,0	3.27	49,0	1.93	12,0	0.47	47,5	1.87	27	--	0,190	0.419
26791-10-12Z*	-10	7/8"-14	20 -12	92,0	3.62	53,5	2.11	15,0	0.59	47,5	1.87	27	--	0,196	0.432
26791-12-08Z*	-12	1.1/16"-12	12 -08	75,0	2.95	43,5	1.71	10,0	0.39	43,0	1.69	32	--	0,150	0.331
26791-12-10Z*	-12	1.1/16"-12	16 -10	83,0	3.27	49,0	1.93	12,0	0.47	49,0	1.93	32	--	0,226	0.498
26791-12-12Z*	-12	1.1/16"-12	20 -12	93,0	3.66	54,5	2.15	15,0	0.59	53,5	2.11	32	--	0,300	0.661
26791-12-16Z*	-12	1.1/16"-12	25 -16	112,5	4.43	65,5	2.58	21,0	0.83	53,5	2.11	32	--	0,320	0.705
26791-14-12Z*	-14	1.3/16"-12	20 -12	93,8	3.69	55,3	2.18	15,0	0.59	53,5	2.11	36	--	0,230	0.507
26791-16-12Z*	-16	1.5/16"-12	20 -12	93,8	3.69	55,3	2.18	15,0	0.59	53,6	2.11	41	--	0,408	0.899
26791-16-16Z*	-16	1.5/16"-12	25 -16	118,0	4.65	71,0	2.80	21,0	0.83	66,1	2.60	41	--	0,460	1.014
26791-16-20Z*	-16	1.5/16"-12	32 -20	135,0	5.31	81,0	3.19	27,0	1.06	66,1	2.60	41	--	0,576	1.270
26791-20-16WZ**	-20	1.5/8"-12	25 -16	118,0	4.65	71,0	2.80	21,0	0.83	69,5	2.74	50	--	0,630	1.389
26791-20-20WZ**	-20	1.5/8"-12	32 -20	135,5	5.33	81,5	3.21	27,0	1.06	80,0	3.15	50	--	0,784	1.728
26791-24-20WZ**	-24	1.7/8"-12	32 -20	135,5	5.33	81,5	3.21	27,0	1.06	81,5	3.21	60	--	0,860	1.896
26791-24-24WZ**	-24	1.7/8"-12	38 -24	177,4	6.98	109,4	4.31	32,0	1.26	94,0	3.70	60	--	1,386	3.056
26791-32-32WZ**	-32	2.1/2"-12	50 -32	205,1	8.07	133,1	5.24	43,0	1.69	121,8	4.80	75	--	2,600	5.732

* Denotes Style 1 design

** Denotes Style 2 wire nut design

ORS

ORS Male Rigid

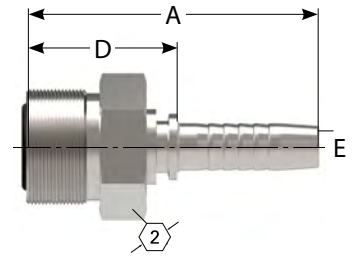

PART		HOSE SIZE INFO			DIMENSIONS								WEIGHT	
#	Terminal End	Thread	Hose Size	A	D Cut Off Factor		E Ø		1	2	Weight			
	Dash Size		DN	Dash Size	mm	in	mm	in	mm	in	mm	mm	kg	lb
14211-04-04Z	-04	9/16"x18	6	-04	50,5	1.99	22,5	0.89	4,0	0.16	--	17	0,030	0.066
14211-06-04Z	-06	11/16"x16	6	-04	52,0	2.05	24,0	0.94	4,0	0.16	--	19	0,038	0.084
14211-06-06Z	-06	11/16"x16	10	-06	54,0	2.13	24,0	0.94	6,7	0.26	--	19	0,040	0.088
14211-08-06Z	-08	13/16"x16	10	-06	57,5	2.26	27,5	1.08	7,0	0.28	--	22	0,060	0.132
14211-08-08Z	-08	13/16"x16	12	-08	60,0	2.36	28,5	1.12	9,6	0.38	--	22	0,070	0.154
14211-10-08Z	-10	1"x14	12	-08	64,0	2.52	32,5	1.28	10,0	0.39	--	27	0,108	0.238
14211-10-10Z	-10	1"x14	16	-10	67,5	2.66	33,5	1.32	12,0	0.47	--	27	0,120	0.264
14211-12-08Z	-12	1.3/16"x12	12	-08	67,0	2.64	35,5	1.40	10,0	0.39	--	32	0,148	0.326
14211-12-10Z	-12	1.3/16"x12	16	-10	70,0	2.76	36,0	1.42	12,0	0.47	--	32	0,164	0.361
14211-12-12Z	-12	1.3/16"x12	20	-12	75,0	2.95	36,5	1.44	15,0	0.59	--	32	0,172	0.378
14211-16-12Z	-16	1.7/16"x12	20	-12	75,5	2.97	37,0	1.46	15,0	0.59	--	38	0,255	0.561
14211-16-16Z	-16	1.7/16"x12	25	-16	85,5	3.37	38,5	1.52	20,6	0.81	--	38	0,248	0.546
14211-20-20Z	-20	1.11/16"x12	32	-20	95,5	3.76	41,5	1.63	26,0	1.02	--	46	0,400	0.880
14211-24-24Z	-24	2"x12	40	-24	114,5	4.51	46,5	1.83	32,0	1.26	--	55	0,624	1.373

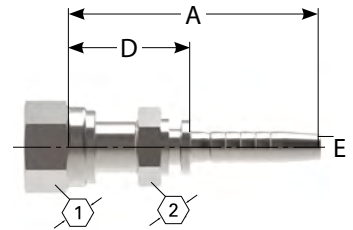

ORS Female Swivel

PART		HOSE SIZE INFO			DIMENSIONS								WEIGHT	
#	Terminal End	Thread	Hose Size	A	D Cut Off Factor		E Ø		1	2	Weight			
	Dash Size		DN	Dash Size	mm	in	mm	in	mm	in	mm	mm	kg	lb
24211D-04-04SMZ	-04	9/16"x18	6	-04	55,5	2.19	27,5	1.08	4,0	0.16	17	14	0,041	0.090
24211D-06-06SMZ	-06	11/16"x16	10	-06	60,0	2.36	30,0	1.18	7,0	0.28	22	17	0,060	0.132
24211D-08-08SMZ	-08	13/16"x16	12	-08	65,0	2.56	33,5	1.32	10,0	0.39	27	19	0,096	0.212
24211D-10-10SMZ	-10	1"x14	16	-10	74,0	2.91	40,0	1.57	12,0	0.47	30	24	0,140	0.309
24211D-12-12SMZ	-12	1.3/16"x12	20	-12	83,8	3.30	45,3	1.78	15,0	0.59	36	30	0,195	0.430
24211D-16-16SMZ	-16	1.7/16"x12	25	-16	95,5	3.76	48,5	1.91	21,0	0.83	41	32	0,260	0.573

Same nipple configuration as 24211 with back up hex

Two-piece fittings

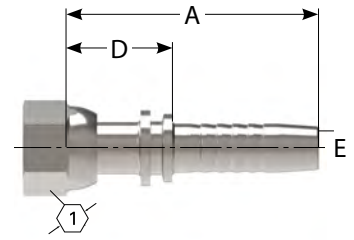

ORS Female Swivel

PART		HOSE SIZE INFO			DIMENSIONS							WEIGHT		
#	Terminal End	Thread	Hose Size	A	D Cut Off Factor		E Ø		1	2	Weight			
	Dash Size		DN	Dash Size	mm	in	mm	in	mm	in	mm	mm	kg	lb
24211-04-04Z*	-04	9/16"×18	6	-04	50,5	1.99	22,5	0.89	4,0	0.16	17	--	0,034	0.075
24211-04-06Z*	-04	9/16"×18	10	-06	52,5	2.07	22,5	0.89	7,0	0.28	17	--	0,043	0.095
24211-06-04TZ**	-06	11/16"×16	6	-04	51,5	2.03	23,5	0.93	4,0	0.16	22	--	0,060	0.132
24211-06-05TZ**	-06	11/16"×16	8	-05	51,5	2.03	23,5	0.93	5,5	0.22	22	--	0,065	0.143
24211-06-06Z*	-06	11/16"×16	10	-06	55,5	2.19	25,5	1	7,0	0.28	22	--	0,055	0.121
24211-08-06TZ**	-08	13/16"×16	10	-06	55,0	2.17	25,0	0.98	7,0	0.28	24	--	0,095	0.209
24211-08-08Z*	-08	13/16"×16	12	-08	59,5	2.34	28,0	1.1	10,0	0.39	27	--	0,086	0.19
24211-10-08TZ**	-10	1"×14	12	-08	61,0	2.4	29,5	1.16	10,0	0.39	30	--	0,130	0.287
24211-10-10Z*	-10	1"×14	16	-10	67,0	2.64	33,0	1.3	12,0	0.47	30	--	0,120	0.265
24211-10-12Z*	-10	1"×14	20	-12	72,0	2.83	33,5	1.32	15,0	0.59	30	--	0,146	0.322
24211-12-08TZ**	-12	1.3/16"×12	12	-08	62,0	2.44	30,5	1.2	10,0	0.39	36	--	0,185	0.408
24211-12-10TZ**	-12	1.3/16"×12	16	-10	65,5	2.58	31,5	1.24	12,0	0.47	36	--	0,210	0.463
24211-12-12Z*	-12	1.3/16"×12	20	-12	73,5	2.89	35,0	1.38	15,0	0.59	36	--	0,195	0.43
24211-12-16Z*	-12	1.3/16"×12	25	-16	83,0	3.27	36,0	1.42	21,0	0.83	36	--	0,236	0.52
24211-16-12TZ**	-16	1.7/16"×12	20	-12	73,5	2.89	35,0	1.38	15,0	0.59	41	--	0,250	0.551
24211-16-16TZ**	-16	1.7/16"×12	25	-16	82,0	3.23	35,0	1.38	21,0	0.83	41	--	0,260	0.573
24211-20-16TZ***	-20	1.11/16"×12	25	-16	81,5	3.21	34,5	1.36	21,0	0.83	50	--	0,385	1.849
24211-20-20WZ***	-20	1.11/16"×12	32	-20	96,5	3.8	42,5	1.67	27,0	1.06	50	--	0,464	1.023
24211-24-24TZ**	-24	2"×12	40	-24	104,0	4.09	36,0	1.42	32,0	1.26	60	--	0,660	1.455

* Denotes Style 1 design

** Denotes Style 2 wire nut design

*** Denotes Style 3 crimp nut design

1. Same nipple configuration as 24211D without back up hex

Two-piece fittings

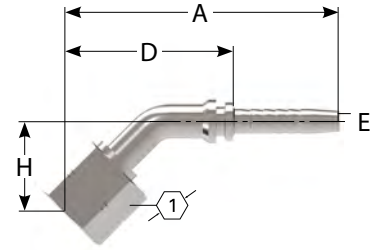

ORS Female 45° Elbow

PART		HOSE SIZE INFO			DIMENSIONS								WEIGHT			
#	Terminal End	Thread	Hose Size	A	D Cut Off Factor		E Ø		H	1	2	Weight				
	Dash Size		DN	Dash Size	mm	in	mm	in	mm	in	mm	in	mm	mm	kg	lb
24241-04-04Z*	-04	9/16"x18	6	-04	73,5	2.89	45,5	1.79	4,0	0.16	23,4	0.92	17	--	0,046	0.101
24241-04-06Z*	-04	9/16"x18	10	-06	75,6	2.98	45,6	1.80	7,0	0.28	23,4	0.92	17	--	0,056	0.123
24241-06-04TZ**	-06	11/16"x16	6	-04	68,9	2.71	40,9	1.61	4,0	0.16	18,8	0.74	22	--	0,070	0.154
24241-06-06Z*	-06	11/16"x16	10	-06	81,3	3.20	51,3	2.02	7,0	0.28	27,1	1.07	22	--	0,078	0.172
24241-06-08Z*	-06	11/16"x16	12	-08	95,7	3.77	64,2	2.53	10,0	0.39	29,3	1.15	22	--	0,132	0.291
24241-08-06TZ**	-08	13/16"x16	10	-06	74,6	2.94	44,6	1.76	7,0	0.28	20,3	0.80	24	--	0,110	0.243
24241-08-08Z*	-08	13/16"x16	12	-08	97,2	3.83	65,7	2.59	10,0	0.39	30,7	1.21	27	--	0,100	0.220
24241-10-08TZ**	-10	1"x14	12	-08	89,7	3.53	58,2	2.29	10,0	0.39	23,3	0.92	30	--	0,162	0.357
24241-10-10Z*	-10	1"x14	16	-10	113,2	4.46	79,2	3.12	12,0	0.47	34,9	1.37	30	--	0,210	0.463
24241-10-12Z*	-10	1"x14	20	-12	124,4	4.90	85,9	3.38	15,0	0.59	38,5	1.52	30	--	0,326	0.719
24241-12-08TZ**	-12	1.3/16"x12	12	-08	89,7	3.53	58,2	2.29	10,0	0.39	23,3	0.92	36	--	0,210	0.463
24241-12-12Z*	-12	1.3/16"x12	20	-12	125,5	4.94	87,0	3.43	15,0	0.59	39,5	1.56	36	--	0,350	0.772
24241-12-16TZ*	-12	1.3/16"x12	25	-16	139,3	5.48	92,3	3.63	21,0	0.83	41,0	1.61	36	--	0,524	1.155
24241-16-16TZ*	-16	1.7/16"x12	25	-16	131,1	5.16	84,1	3.31	21,0	0.83	29,7	1.17	41	--	0,423	0.933
24241-20-20WZ***	-20	1.11/16"x12	32	-20	165,2	6.50	111,2	4.38	27,0	1.06	49,0	1.93	50	--	0,740	1.631
24241-24-24TZ**	-24	2"x12	40	-24	176,5	6.95	108,5	4.27	32,0	1.26	37,7	1.48	60	--	1,236	2.725

* Denotes Style 1 design

** Denotes Style 2 wire nut design

*** Denotes Style 3 crimp nut design

Two-piece fittings

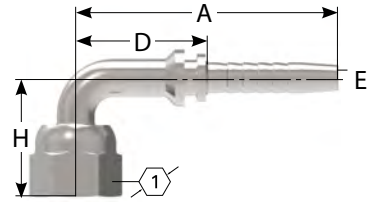

ORS Female 90° Elbow

PART		HOSE SIZE INFO			DIMENSIONS										WEIGHT	
#	Terminal End	Thread	Hose Size	A	D Cut Off Factor		E Ø		H		1	2	kg	lb		
	Dash Size	DN	Dash Size	mm	in	mm	in	mm	in	mm	in	mm	mm			
24291-04-04Z*	-04	9/16"×18	6	-04	58,0	2.28	30,0	1.18	4,0	0.16	41,0	1.61	17	--	0,052	0.115
24291-06-04TZ**	-06	11/16"×16	6	-04	58,0	2.28	30,0	1.18	4,0	0.16	34,5	1.36	22	--	0,065	0.143
24291-06-06Z*	-06	11/16"×16	10	-06	65,3	2.57	35,3	1.39	7,0	0.28	42,5	0.17	22	--	0,090	0.198
24291-06-08Z*	-06	11/16"×16	10	-06	67,3	2.65	35,8	1.41	10,0	0.39	49,3	1.94	22	--	0,098	0.216
24291-08-06TZ**	-08	13/16"×16	10	-06	65,3	2.57	35,3	1.39	7,0	0.28	39,8	1.56	24	--	0,120	0.265
24291-08-08Z*	-08	13/16"×16	12	-08	72,5	2.85	41,0	1.61	10,0	0.39	57,5	2.26	27	--	0,145	0.320
24291-10-08TZ**	-10	1"×14	12	-08	72,5	2.85	41,0	1.61	10,0	0.39	46,0	1.81	30	--	0,174	0.384
24291-10-10Z*	-10	1"×14	16	-10	90,0	3.54	56,0	2.20	12,0	0.47	66,0	2.60	30	--	0,235	0.518
24291-10-12Z*	-10	1"×14	20	-12	95,5	3.76	57,0	2.24	15,0	0.59	66,0	2.60	30	--	0,282	0.622
24291-12-12Z*	-12	1.3/16"×12	20	-12	104,0	4.09	65,5	2.58	15,0	0.59	77,0	3.03	36	--	0,390	0.860
24291-12-08TZ**	-12	1.3/16"×12	12	-8	84,0	3.31	52,5	2.07	10,0	0.39	51,5	2.03	36	--	0,282	0.622
24291-16-12TZ**	-16	1.7/16"×12	20	-12	104,0	4.09	65,5	2.58	15,0	0.59	63,0	2.48	41	--	0,410	0.904
24291-16-16TZ**	-16	1.7/16"×12	25	-16	123,9	4.88	76,9	3.03	21,0	0.83	67,5	2.66	41	--	0,504	1.111
24291-20-16TZ**	-20	1.11/16"×12	25	-16	123,7	4.87	76,7	3.02	21,0	0.83	67,5	2.66	50	--	0,622	1.371
24291-20-20WZ***	-20	1.11/16"×12	32	-20	147,0	5.79	93,0	3.66	27,0	1.06	100,0	3.94	50	--	0,862	1.900
24291-24-24TZ**	-24	2"×12	40	-24	177,4	6.98	109,4	4.31	32,0	1.26	92,0	3.62	60	--	1,372	3.025

* Denotes Style 1 design

** Denotes Style 2 wire nut design

*** Denotes Style 3 crimp nut design

BSP

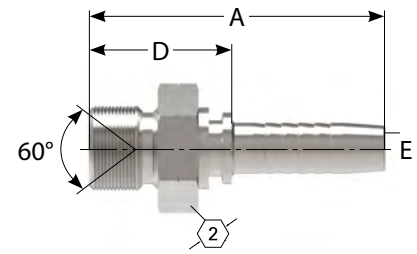

BSP 60° Cone Male Rigid

PART		HOSE SIZE INFO			DIMENSIONS							WEIGHT		
#	Terminal End	Thread	Hose Size	A	D Cut Off Factor		E Ø		1	2	Weight			
	Dash Size		DN	Dash Size	mm	in	mm	in	mm	in	mm	mm	kg	lb
12611A-02-04Z	-02	G1/8"x28	6	-04	50,5	1.99	22,5	0.89	4,0	0.16	--	14,0	0,020	0.044
12611A-04-04Z	-04	G1/4"x19	6	-04	52,5	2.07	24,5	0.96	4,0	0.16	--	19,0	0,030	0.066
12611A-06-04Z	-06	G3/8"x19	6	-04	56,0	2.20	28,0	1.10	4,0	0.16	--	22,0	0,045	0.099
12611A-06-05Z	-06	G3/8"x19	8	-05	56,0	2.20	28,0	1.10	5,5	0.22	--	22,0	0,052	0.114
12611A-06-06Z	-06	G3/8"x19	10	-06	58,0	2.28	28,0	1.10	7,0	0.28	--	22,0	0,050	0.110
12611A-06-08Z	-06	G3/8"x19	12	-08	60,0	2.36	28,5	1.12	10,0	0.39	--	22,0	0,058	0.128
12611A-08-06Z	-08	G1/2"x14	10	-06	63,0	2.48	33,0	1.30	7,0	0.28	--	27,0	0,082	0.180
12611A-08-08Z	-08	G1/2"x14	12	-08	64,5	2.54	33,0	1.30	10,0	0.39	--	27,0	0,090	0.198
12611A-10-10Z	-10	G5/8"x14	16	-10	69,5	2.74	35,5	1.40	12,0	0.47	--	30,0	0,121	0.266
12611A-12-12Z	-12	G3/4"x14	20	-12	76,0	2.99	37,5	1.48	15,0	0.59	--	32,0	0,150	0.330
12611A-16-12Z	-16	G1"x11	20	-12	81,0	3.19	42,5	1.67	15,0	0.59	--	41,0	0,230	0.506
12611A-16-16Z	-16	G1"x11	25	-16	90,5	3.56	43,5	1.71	21,0	0.83	--	41,0	0,253	0.557
12611A-20-20Z	-20	G1.1/4"x11	32	-20	100,0	3.94	46,5	1.83	27,0	1.06	--	50,0	0,406	0.893
12611A-24-24Z	-24	G1.1/2"x11	40	-24	117,0	4.61	49,0	1.93	32,0	1.26	--	55,0	0,554	1.219

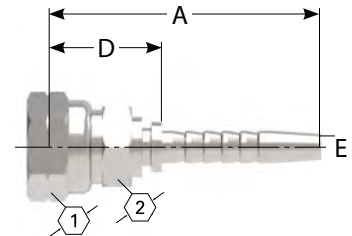

BSP 60° Cone Female Swivel

PART		HOSE SIZE INFO			DIMENSIONS							WEIGHT		
#	Terminal End	Thread	Hose Size	A	D Cut Off Factor		E Ø		1	2	Weight			
	Dash Size		DN	Dash Size	mm	in	mm	in	mm	in	mm	mm	kg	lb
22611D-04-04Z	-04	G1/4"X19	6	-04	51,5	2.03	32,5	1.28	4,0	0.16	19	19	0,044	0.097
22611D-06-06Z	-06	G3/8"X19	10	-06	56,5	2.22	26,5	1.04	7,0	0.28	22	22	0,065	0.143
22611D-08-08Z	-08	G1/2"X14	12	-08	62,5	2.46	31,0	1.22	10,0	0.39	27	27	0,120	0.264
22611D-12-12Z	-12	G3/4"X14	20	-12	72,0	2.83	33,5	1.32	15,0	0.59	32	32	0,190	0.418
22611D-16-16Z	-16	G1"X11	25	-16	82,5	3.25	35,5	1.40	21,0	0.83	41	41	0,296	0.651

1. Same nipple configuration as 26611 with back up hex

Two-piece fittings

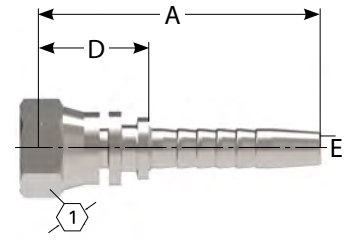

BSP 60° Cone Female Swivel

PART #	HOSE SIZE INFO			DIMENSIONS								WEIGHT		
	Terminal End	Thread	Hose Size	A		D Cut Off Factor		E Ø		1	2	Weight		
	Dash Size		DN	Dash Size	mm	in	mm	in	mm	in	mm	mm	kg	lb
22611-04-04Z*	-04	G1/4"X19	6	-04	46,0	1.81	18,0	0.71	4,0	0.16	19	--	0,032	0.070
22611-04-05Z*	-04	G1/4"X19	8	-05	46,0	1.81	18,0	0.71	5,0	0.20	19	--	0,035	0.077
22611-04-06Z*	-04	G1/4"X19	10	-06	48,0	1.89	18,0	0.71	7,0	0.28	19	--	0,040	0.088
22611-06-04TZ**	-06	G3/8"X19	6	-04	45,5	1.79	17,5	0.69	4,0	0.16	22	--	0,050	0.110
22611-06-05Z*	-06	G3/8"X19	8	-05	47,0	1.85	19,0	0.75	5,5	0.22	22	--	0,044	0.097
22611-06-06Z*	-06	G3/8"X19	10	-06	49,5	1.95	19,5	0.77	7,0	0.28	22	--	0,046	0.101
22611-06-08Z*	-06	G3/8"X19	12	-08	51,0	2.01	19,5	0.77	10,0	0.39	22	--	0,060	0.132
22611-08-06TZ**	-08	G1/2"X14	10	-06	48,5	1.91	18,5	0.73	7,0	0.28	27	--	0,080	0.176
22611-08-08Z*	-08	G1/2"X14	12	-08	53,0	2.09	21,5	0.85	10,0	0.39	27	--	0,078	0.172
22611-08-10Z*	-08	G1/2"X14	16	-10	56,5	2.22	22,5	0.89	12,0	0.47	27	--	0,092	0.202
22611-10-08Z*	-10	G5/8"X14	12	-08	53,5	2.11	22,0	0.87	10,0	0.39	30	--	0,100	0.220
22611-10-10Z*	-10	G5/8"X14	16	-10	57,0	2.24	23,0	0.91	12,0	0.47	30	--	0,114	0.251
22611-12-08TZ**	-12	G3/4"X14	12	-08	51,5	2.03	20,0	0.79	10,0	0.39	32	--	0,130	0.286
22611-12-10Z*	-12	G3/4"X14	16	-10	57,5	2.26	23,5	0.93	12,0	0.47	32	--	0,126	0.277
22611-12-12Z*	-12	G3/4"X14	20	-12	62,5	2.46	24,0	0.94	15,0	0.59	32	--	0,132	0.290
22611-16-12TZ**	-16	G1"X11	20	-12	61,5	2.42	23,0	0.91	15,0	0.59	41	--	0,220	0.484
22611-16-16Z*	-16	G1"X11	25	-16	74,0	2.91	27,0	1.06	21,0	0.83	41	--	0,226	0.497
22611-20-16TZ**	-20	G1.1/4"X11	25	-16	74,0	2.91	27,0	1.06	21,0	0.83	50	--	0,350	0.770
22611-24-20TZ**	-24	G1.1/2"X11	32	-20	83,5	3.29	29,5	1.16	27,0	1.06	55	--	0,466	1.025
22611-20-20WZ***	-20	G1.1/4"X11	32	-20	84,5	3.33	30,5	1.20	27,0	1.06	50	--	0,406	0.893
22611-24-24WZ***	-24	G1.1/2"X11	40	-24	100,0	3.94	32,0	1.26	32,0	1.26	55	--	0,546	1.201
22611-32-32WZ***	-32	G2"X11	50	-32	103,0	4.06	31,0	1.22	43,0	1.69	70	--	0,960	2.112

* Denotes Style 1 design

** Denotes Style 2 wire nut design

*** Denotes Style 3 crimp nut design

1. Same nipple configuration as 22611D without back up hex

Two-piece fittings

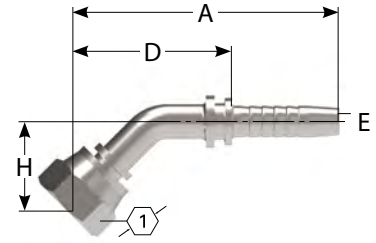

BSP 60° Cone Female 45° Elbow

PART		HOSE SIZE INFO			DIMENSIONS								WEIGHT			
#	Terminal End	Thread	Hose Size	A		D Cut Off Factor		E Ø		H		1	2	Weight		
	Dash Size		DN	Dash Size	mm	in	mm	in	mm	in	mm	mm	mm	kg	lb	
22641-04-04Z*	-04	G1/4"X19	6	-04	70,3	2.77	42,3	1.67	4,0	0.16	20,2	0.80	19	--	0,046	0.101
22641-06-04Z*	-06	G3/8"X19	6	-04	71,2	2.80	43,2	1.70	4,0	0.16	21,1	0.83	22	--	0,055	0.121
22641-06-06Z*	-06	G3/8"X19	10	-06	76,9	3.03	46,9	1.85	7,0	0.28	22,6	0.89	22	--	0,070	0.154
22641-08-06Z	-06	G1/2"X14	10	-06	76,7	3.02	46,7	1.84	7,0	0.28	22,5	0.89	27	--	0,104	0.229
22641-08-08Z*	-08	G1/2"X14	12	-08	92,6	3.65	61,1	2.41	10,0	0.39	26,1	1.03	27	--	0,130	0.286
22641-10-10Z*	-10	G5/8"X14	16	-10	106,1	4.18	72,1	2.84	12,0	0.47	27,8	1.09	30	--	0,196	0.431
22641-12-12Z*	-12	G3/4"X14	20	-12	117,1	4.61	78,6	3.09	15,0	0.59	31,8	1.25	32	--	0,285	0.627
22641-16-16Z*	-16	G1"X11	25	-16	135,4	5.33	88,4	3.48	21,0	0.83	34,2	1.35	41	--	0,402	0.884
22641-20-20WZ**	-20	G1.1/4"X11	32	-20	152,8	6.02	98,8	3.89	27,0	1.06	38,0	1.50	50	--	0,650	1.430
22641-24-24WZ**	-24	G1.1/2"X11	40	-24	184,2	7.25	116,2	4.57	32,0	1.26	45,5	1.79	55	--	1,095	2.409
22641-32-32WZ**	-32	G2"X11	50	-32	207,7	8.18	135,7	5.34	43,0	1.69	52,7	2.07	70	--	1,898	4.176

* Denotes Style 1 design

** Denotes Style 2 wire nut design

Two-piece fittings

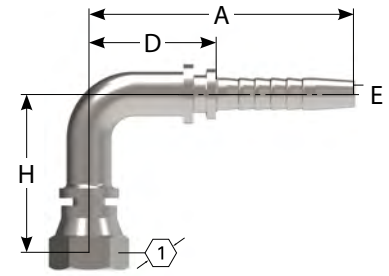

BSP 60° Cone Female 90° Elbow

PART		HOSE SIZE INFO			DIMENSIONS								WEIGHT			
#	Terminal End	Thread	Hose Size	A		D Cut Off Factor		E Ø		H		1	2	kg	lb	
	Dash Size	DN	Dash Size	mm	in	mm	in	mm	in	mm	in	mm	mm			
22691-04-04Z*	-04	G1/4"X19	6	-04	58,0	2.28	30,0	1.18	4,0	0.16	36,5	1.44	19	--	0,048	0.106
22691-04-05Z*	-04	G1/4"X19	8	-05	61,0	2.40	33,0	1.30	5,5	0.22	39,5	1.56	19	--	0,060	0.132
22691-04-06Z*	-04	G1/4"X19	10	-06	60,0	2.36	30,0	1.18	7,0	0.28	36,5	1.44	19	--	0,055	0.121
22691-06-04TZ*	-06	G3/8"X19	6	-04	58,0	2.28	30,0	1.18	4,0	0.16	35,7	1.41	22	--	0,070	0.154
22691-06-06Z*	-06	G3/8"X19	10	-06	65,3	2.57	35,3	1.39	7,0	0.28	43,0	1.69	22	--	0,080	0.176
22691-06-08Z*	-06	G3/8"X19	12	-08	72,5	2.85	41,0	1.61	10,0	0.39	49,2	1.94	22	--	0,126	0.277
22691-08-06TZ*	-08	G1/2"X14	10	-06	65,3	2.57	35,3	1.39	7,0	0.28	41,8	1.65	27	--	0,115	0.253
22691-08-08Z*	-08	G1/2"X14	12	-08	72,5	2.85	41,0	1.61	10,0	0.39	51,0	2.01	27	--	0,134	0.293
22691-10-08Z*	-10	G5/8"X14	12	-08	72,5	2.85	41,0	1.61	10,0	0.39	51,5	2.03	30	--	0,160	0.352
22691-10-10Z*	-10	G5/8"X14	16	-10	90,0	3.54	56,0	2.20	12,0	0.47	56,0	2.20	30	--	0,218	0.480
22691-12-10Z*	-12	G3/4"X14	16	-10	90,0	3.54	56,0	2.20	12,0	0.47	56,6	2.23	32	--	0,228	0.502
22691-12-12Z*	-12	G3/4"X14	20	-12	103,4	4.07	64,9	2.56	15,0	0.59	66,0	2.60	32	--	0,330	0.726
22691-16-12TZ**	-16	G1"X11	20	-12	104,0	4.09	65,5	2.58	15,0	0.59	63,8	2.51	41	--	0,360	0.660
22691-16-16Z*	-16	G1"X11	25	-16	123,7	4.87	76,7	3.02	21,0	0.83	73,8	2.91	41	--	0,495	1.089
22691-20-20WZ***	-20	G1.1/4"X11	32	-20	145,5	5.73	91,5	3.60	27,0	1.06	84,3	3.32	50	--	0,775	1.705
22691-24-24WZ***	-24	G1.1/2"X11	40	-24	177,4	6.98	109,4	4.31	32,0	1.26	103,0	4.06	55	--	1,395	3.069
22691-32-32WZ***	-32	G2"X11	50	-32	203,8	8.02	131,8	5.19	43,0	1.69	123,3	4.85	70	--	2,360	5.192

* Denotes Style 1 design

** Denotes Style 2 wire nut design

*** Denotes Style 3 crimp nut design

NPTF

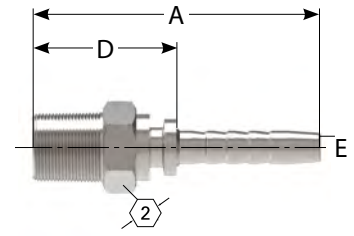

NPTF Male Rigid

PART		HOSE SIZE INFO			DIMENSIONS							WEIGHT		
#	Terminal End	Thread	Hose Size	A	D Cut Off Factor		E Ø		1	2	Weight			
	Dash Size		DN	Dash Size	mm	in	mm	in	mm	in	mm	mm	kg	lb
15611-F02-04Z	-02	1/8"x27	6	-04	50,5	1.99	22,5	0.89	4,0	0.16	--	12	0,015	0.033
15611-F04-04Z	-04	1/4"x18	6	-04	56,0	2.20	28,0	1.10	4,0	0.16	--	17	0,030	0.066
15611-F04-05Z	-04	1/4"x18	8	-05	56,0	2.20	28,0	1.10	4,0	0.16	--	17	0,030	0.066
15611-F04-06Z	-04	1/4"x18	10	-06	57,5	2.26	27,5	1.08	7,0	0.28	--	17	0,032	0.070
15611-F06-04Z	-06	3/8"x18	6	-04	57,0	2.24	29,0	1.14	4,0	0.16	--	19	0,038	0.084
15611-F06-05Z	-06	3/8"x18	8	-05	57,0	2.24	29,0	1.14	5,5	0.22	--	19	0,044	0.097
15611-F06-06Z	-06	3/8"x18	10	-06	59,0	2.32	29,0	1.14	7,0	0.28	--	19	0,048	0.106
15611-F06-08Z	-06	3/8"x18	12	-08	62,0	2.44	30,5	1.20	9,0	0.35	--	19	0,060	0.132
15611-F08-04Z	-08	1/2"x14	6	-04	62,0	2.44	34,0	1.34	4,0	0.16	--	22	0,066	0.145
15611-F08-06Z	-08	1/2"x14	10	-06	64,0	2.52	34,0	1.34	7,0	0.28	--	22	0,068	0.150
15611-F08-08Z	-08	1/2"x14	12	-08	66,0	2.60	34,5	1.36	10,0	0.39	--	22	0,075	0.165
15611-F08-10Z	-08	1/2"x14	16	-10	69,5	2.74	35,5	1.40	12,0	0.47	--	22	0,085	0.187
15611-F08-12Z	-08	1/2"x14	20	-12	76,5	3.01	38,0	1.50	15,0	0.59	--	27	0,124	0.273
15611-F12-08Z	-12	3/4"x14	12	-08	69,0	2.72	37,5	1.48	10,0	0.39	--	27	0,103	0.227
15611-F12-10Z	-12	3/4"x14	16	-10	71,5	2.81	37,5	1.48	12,0	0.47	--	27	0,130	0.286
15611-F12-12Z	-12	3/4"x14	20	-12	77,0	3.03	38,5	1.52	15,0	0.59	--	27	0,130	0.286
15611-F12-16Z	-12	3/4"x14	25	-16	86,5	3.41	39,5	1.56	21,0	0.83	--	32	0,190	0.418
15611-F16-12Z	-16	1"x11.5	20	-12	83,5	3.29	45,0	1.77	15,0	0.59	--	36	0,210	0.462
15611-F16-16Z	-16	1"x11.5	25	-16	93,5	3.68	46,5	1.83	21,0	0.83	--	36	0,230	0.506
15611-F20-16Z	-20	1.1/4"x11.5	25	-16	96,5	3.80	49,5	1.95	21,0	0.83	--	46	0,344	0.757
15611-F20-20Z	-20	1.1/4"x11.5	32	-20	104,5	4.11	50,5	1.99	27,0	1.06	--	46	0,406	0.893
15611-F24-24Z	-24	1.1/2"x11.5	40	-24	119,0	4.69	51,0	2.01	32,0	1.26	--	50	0,550	1.210
15611-F32-32Z	-32	2"x11.5	50	-32	127,0	5.00	55,0	2.17	43,0	1.69	--	65	0,945	2.079

Two-piece fittings

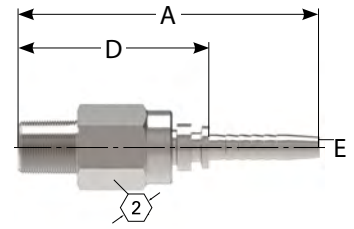

NPTF Male Swivel

PART		HOSE SIZE INFO			DIMENSIONS								WEIGHT	
#	Terminal End	Thread	Hose Size	A	D Cut Off Factor		E Ø		1	2	Weight			
	Dash Size		DN	Dash Size	mm	in	mm	in	mm	in	mm	mm	kg	lb
15611SW-F04-04SZ	-04	1/4"x18	6	-04	76,0	2.99	48,0	1.89	4,0	0.16	--	19	0,064	0.141
15611SW-F06-06SZ	-06	3/8"x18	10	-06	85,0	3.35	55,0	2.17	7,0	0.28	--	22	0,100	0.220
15611SW-F08-06SZ	-08	1/2"x14	10	-06	87,0	3.43	57,0	2.24	7,0	0.28	--	22	0,152	0.334
15611SW-F08-08SZ	-08	1/2"x14	12	-08	88,5	3.49	57,0	2.24	10,0	0.39	--	27	0,152	0.334
15611SW-F12-12SZ	-12	3/4"x14	20	-12	99,0	3.90	60,5	2.38	15,0	0.59	--	32	0,225	0.495
15611SW-F16-16SZ	-16	1"x11.5	25	-16	116,5	4.59	69,5	2.74	21,0	0.83	--	41	0,375	0.825

Staple-Lock

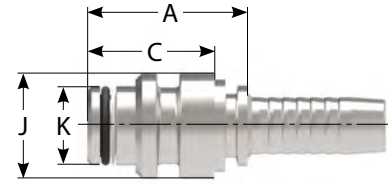

Male DN Series D Type

PART	HOSE SIZE INFO			DIMENSIONS			
	# BRAIDED	DN	Dash	O-RNG Hose Size	A	C	J
	DN	Dash Size		mm			
60011-04-04DZ	6	4	O06.0X2.0	36	29	15	10
60011-06-06DZ	10	6	O10.0X2.0	36	29	20	14
60011-08-08DZ	12	8	O10.0X2.0	36.5	29	24	18
60011-10-10DZ	16	10	O10.0X2.0	37.5	29	26	21
60011-12-12DZ	20	12	O19.0X2.5	38	29	29	24
60011-16-16DZ	25	16	O25.0X2.5	45	35	39	31
60011-20-20DZ	32	20	O33.0X2.5	47	35	46	38
60011-24-24DZ	40	24	O40.0X3.0	52	40	55	47
60011-32-32DZ	50	32	O49.0X3.0	52	40	64	56

DIN 24° DKO Light (DKO-L)

Male Rigid DIN 24 seat (DK) I.Rh DKO (Light) Straight

PART		HOSE SIZE INFO			DIMENSIONS						
#	Terminal End	Hose Size	Thread	A		D		E Ø		1	
1T	Dash Size	DN	Dash Size	Metric	mm	in	mm	in	mm	in	mm
1T10DK6	12L	10	-6	M18X1,5	53,5	2.11	24	0.95	6,5	0.26	19
1T12DK8	15L	12	-8	M22X1,5	58	2.29	25	0.99	9,1	0.36	24
1T16DK10	18L	16	-10	M26X1,5	62	2.44	25,4	1.00	12,1	0.48	27

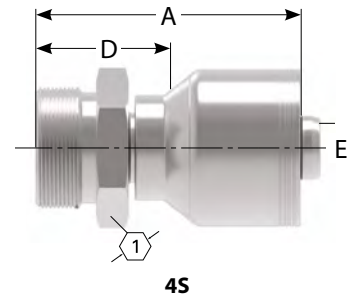

Female Swivel DIN 24° seat (DL) I.Rh DKO (Light) Straight

PART		HOSE SIZE INFO			DIMENSIONS						
#	Terminal End	Hose Size	Thread	A		D		E Ø		1	
1T	Dash Size	DN	Dash Size	Metric	mm	in	mm	in	mm	in	mm
1T10DL6	12L	10	-6	M18X1,5	55	2.17	25,5	1.00	6,5	0.26	22
1T12DL8	15L	12	-8	M22X1,5	58	2.29	25	0.99	8	0.32	27
1T16DL10	18L	16	-10	M26X1,5	62	2.44	25,4	1.00	12,1	0.48	32
4S	Dash Size	DN	Dash Size	Metric	mm	in	mm	in	mm	in	mm
4S20DL12	22L	19	-12	M30X2	76,0	2.99	39,7	1.56	14,2	0.56	36,0
4S25DL16	28L	25	-16	M36X2	79,7	3.14	40,3	1.59	19,2	0.76	41,0
4S32DL20	35L	31	-20	M45X2	100,5	3.96	45,5	1.79	25,2	0.99	50,0

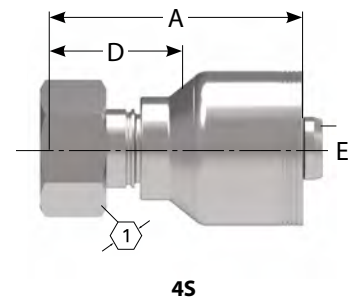

DIN 24° DKO Heavy (DKO-S)

Male DIN 24° Seat Rigid (EK) S.Rh. DKO (Heavy) Straight

PART		HOSE SIZE INFO			DIMENSIONS						
#	Terminal End	Hose Size	Thread	A	D	E Ø					1
1T	Dash Size	DN	Dash Size	Metric	mm	in	mm	in	mm	in	mm
1T8EK6	12S	10	-6	M20X1,5	54	2.13	24.5	0.97	6.5	0.26	22
1T12EK8	16S	12	-8	M24X1,5	60	2.36	27	1.06	9	0.35	27
1T16EK10	20S	16	-10	M30X2	68	2.68	31.4	1.24	12	0.47	32
4S	Dash Size	DN	Dash Size	Metric	mm	in	mm	in	mm	in	mm
4S20EK12	25S	19	-12	M36X2	78,6	3.09	42,3	1.67	14,2	0.56	41,0
4S25EK16	30S	25	-16	M42X2	83,7	3.30	44,0	1.73	19,2	0.75	46,0
4S32EK20	38S	31	-20	M52X2	106,9	4.21	51,7	2.04	25,2	0.99	55,0

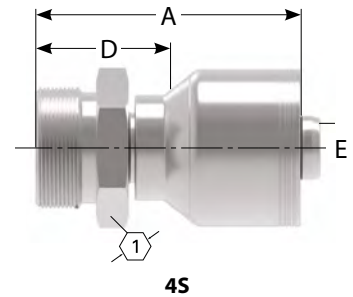

Female Swivel DIN 24° Seat (DS) S.Rh DKO (Heavy) Straight

PART		HOSE SIZE INFO			DIMENSIONS						
#	Terminal End	Hose Size	Thread	A	D	E Ø					1
1T	Dash Size	DN	Dash Size	Metric	mm	in	mm	in	mm	in	mm
1T8DS6	12S	10	-6	M20X1,5	58.2	2.29	28.7	1.13	6.5	0.26	24
1T12DS8	16S	12	-8	M24X1,5	61.2	2.41	28	1.10	6.5	0.26	30
1T12DS10	16S	12	-8	M24X1,5	65	2.56	32	1.26	9	0.35	30
1T16DS10	20S	16	-10	M30X2	68.5	2.70	31.9	1.26	11	0.43	36
4S	Dash Size	DN	Dash Size	Metric	mm	in	mm	in	mm	in	mm
4S16DS12	20S	19	-12	M30X2	73,7	2.90	37,4	1.47	14,2	0.56	36,0
4S20DS12	25S	19	-12	M36X2	86,6	3.41	50,3	1.98	14,2	0.56	46,0
4S25DS12	30S	19	-12	M42X2	88,2	3.47	51,9	2.04	14,2	0.56	50,0
4S25DS16	30S	25	-16	M42X2	91,1	3.59	51,4	2.02	19,2	0.76	50,0
4S32DS16	38S	25	-16	M52X2	94,5	3.72	55,3	2.18	19,2	0.76	60,0
4S25DS20	30S	31	-20	M42X2	96,6	3.80	41,6	1.64	22,1	0.87	50,0
4S32DS20	38S	31	-20	M52X2	111,5	4.39	56,5	2.22	25,2	0.99	60,0
6S	Dash Size	DN	Dash Size	Metric	mm	in	mm	in	mm	in	mm
6S25DS16	30S	25	-16	M42X2	91,1	3.59	51,4	2.02	19,2	0.76	50,0
6S32DS16	38S	25	-16	M52X2	95,0	3.74	55,3	2.18	19,2	0.76	60,0
6S32DS20	38S	31	-20	M52X2	112,5	4.43	56,5	2.22	25,2	0.99	60,0

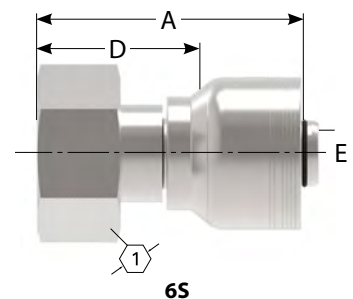
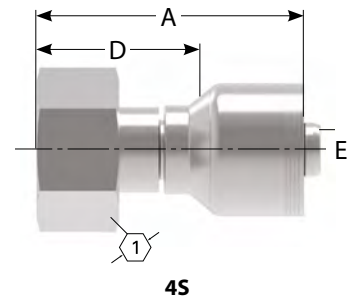

DIN 24° DKO Heavy (DKO-S)

Female Swivel DIN 24° Seat (DSA) S.Rh DKO (heavy) 45° Elbow

PART		HOSE SIZE INFO				DIMENSIONS							
#	Terminal End	Hose Size		Thread	A		D		E Ø		H		1
1T	Dash Size	DN	Dash Size	Metric	mm	in	mm	in	mm	in	mm	in	mm
1T8DSA6	12S	10	-6	M20X1,5	73.1	2.88	43.6	1.72	6.5	0.26	17.1	0.67	24
1T12DSA8	16S	12	-8	M24X1,5	73.7	2.90	44.2	1.74	6.5	0.26	18.2	0.72	30
1T16DSA10	20S	16	-10	M30X2	96	3.78	63	2.48	9	0.35	28.5	1.12	36
4S	Dash Size	DN	Dash Size	Metric	mm	in	mm	in	mm	in	mm	in	mm
4S20DSA12	25S	19	-12	M36X2	116,7	4.59	80,4	3.17	14,2	0.56	32,0	1.26	46,0
4S25DSA12	30S	19	-12	M42X2	130,8	5.15	94,4	3.72	14,2	0.56	35,0	1.38	50,0
4S25DSA16	30S	25	-16	M42X2	134,2	5.28	94,4	3.72	19,2	0.76	35,0	1.38	50,0
4S32DSA16	38S	25	-16	M52X2	145,1	5.71	105,3	4.15	19,2	0.76	39,0	1.54	60,0
4S32DSA20	38S	31	-20	M52X2	161,3	6.35	106,3	4.19	25,2	0.99	39,0	1.54	60,0
6S	Dash Size	DN	Dash Size	Metric	mm	in	mm	in	mm	in	mm	in	mm
6S25DSA16	30S	25	-16	M42X2	134,1	5.28	94,4	3.72	19,2	0.76	35,0	1.38	50,0
6S32DSA16	38S	25	-16	M52X2	145,1	5.71	105,3	4.15	19,2	0.76	39,0	1.54	60,0
6S32DSA20	38S	31	-20	M52X2	162,4	6.39	106,3	4.19	25,2	0.99	39,0	1.54	60,0

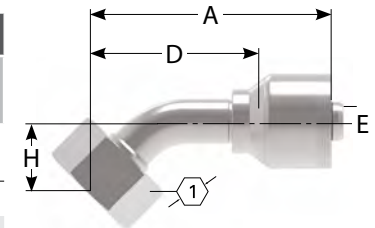

4S

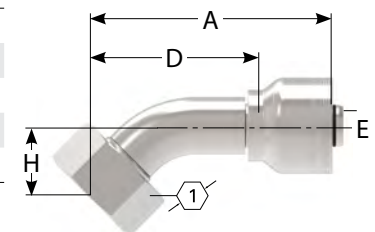

6S

Female swivel DIN 24° Seat (DSB) S.Rh DKO (heavy) 90° Elbow

PART		HOSE SIZE INFO				DIMENSIONS							
#	Terminal End	Hose Size		Thread	A		D		E Ø		H		1
1T	Dash Size	DN	Dash Size	Metric	mm	in	mm	in	mm	in	mm	in	mm
1T8DSB6	12S	10	-6	M20X1,5	67.5	2.66	38	1.50	6.5	0.26	37	1.46	24
1T12DSB8	16S	12	-8	M24X1,5	83	3.27	50	1.97	9	0.35	55	2.17	30
1T12DSB10	16S	16	-10	M24X1,5	87	3.43	50.4	1.99	12	0.47	50	1.97	30
1T16DSB10	20S	16	-10	M30X2	92	3.62	55.4	2.18	12	0.47	61.5	2.42	36
4S	Dash Size	DN	Dash Size	Metric	mm	in	mm	in	mm	in	mm	in	mm
4S20DSB12	25S	19	-12	M36X2	103,9	4.09	67,7	2.67	14,2	0.56	65,0	2.56	46,0
4S25DSB12	30S	19	-12	M42X2	122,7	4.83	86,4	3.40	14,2	0.56	76,0	2.99	50,0
4S25DSB16	30S	25	-16	M42X2	124,5	4.90	84,8	3.34	19,2	0.76	76,0	2.99	50,0
4S32DSB16	38S	25	-16	M52X2	136,7	5.38	97,0	3.82	19,2	0.76	89,0	3.50	60,0
4S32DSB20	38S	31	-20	M52X2	153,0	6.02	98,0	3.86	25,2	0.99	89,0	3.50	60,0
6S	Dash Size	DN	Dash Size	Metric	mm	in	mm	in	mm	in	mm	in	mm
6S25DSB16	30S	25	-16	M42X2	124,5	4.90	84,8	3.34	19,2	0.76	76,0	2.99	50,0
6S32DSB16	38S	25	-16	M52X2	136,7	5.38	97,0	3.82	19,2	0.76	89,0	3.50	60,0
6S32DSB20	38S	31	-20	M52X2	154,2	6.07	98,0	3.86	25,2	0.99	89,0	3.50	60,0

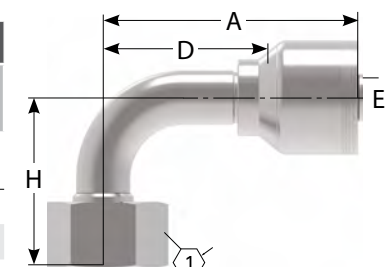

4S

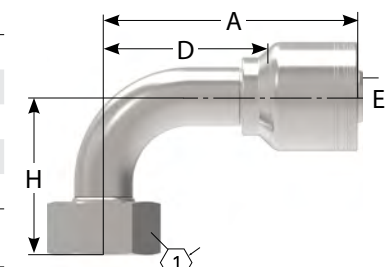

6S

Code 61 Flange

SAE Code 61 Flange (FL) Straight

PART #	HOSE SIZE INFO					DIMENSIONS					
	Terminal End	Hose Size		Flange Head Dia. K Ø		A		D		E Ø	
1T	Dash Size	DN	Dash Size	mm	in	mm	in	mm	in	mm	in
1T8FL8	-8	12	-8	30,2	1.19	83	3.27	50	1.97	9	0.35
1T12FL10	-12	16	-10	38,1	1.50	94	3.70	57,4	2.26	12	0.47
4S	Dash Size	DN	Dash Size	mm	in	mm	in	mm	in	mm	in
4S12FL12	-12	19	-12	38,1	1.50	90,7	3.57	54,5	2.15	14,2	0.56
4S16FL12	-16	19	-12	44,5	1.75	90,2	3.55	54,0	2.13	14,2	0.56
4S20FL12	-20	19	-12	50,8	2.00	97,7	3.85	61,5	2.42	14,2	0.56
4S16FL16	-16	25	-16	44,5	1.75	93,3	3.67	53,6	2.11	19,2	0.76
4S20FL16	-20	25	-16	50,8	2.00	100,8	3.97	61,1	2.41	19,2	0.76
4S24FL16	-24	25	-16	60,4	2.38	97,4	3.83	57,7	2.27	19,2	0.76
4S16FL20	-16	31	-20	44,5	1.75	110,5	4.35	55,5	2.18	25,2	0.99
4S20FL20	-20	31	-20	50,8	2.00	117,4	4.62	62,2	2.45	25,2	0.99
4S24FL20	-24	31	-20	60,4	2.38	106,7	4.20	51,6	2.03	25,2	0.99
4S32FL20	-32	31	-20	71,4	2.81	104,9	4.13	49,9	1.96	25,2	0.99
4S24FL24	-24	38	-24	60,4	2.38	171,6	6.75	93,6	3.68	31,1	1.22
4S32FL24	-32	38	-24	71,4	2.81	174,7	6.88	96,7	3.81	31,1	1.22
4S32FL32	-32	51	-32	71,4	2.81	177,5	6.99	99,5	3.92	42,1	1.66
6S	Dash Size	DN	Dash Size	mm	in	mm	in	mm	in	mm	in
6S16FL16	-16	25	-16	44,5	1.75	93,3	3.67	53,6	2.11	19,2	0.76
6S20FL20	-20	31	-20	50,8	2.00	118,2	4.65	62,2	2.45	25,2	0.99
6S24FL24	-24	38	-24	60,4	2.38	171,6	6.75	93,6	3.68	31,1	1.22
6S32FL24	-32	38	-24	71,4	2.81	174,7	6.88	96,7	3.81	31,1	1.22
6S32FL32	-32	51	-32	71,4	2.81	177,5	6.99	99,5	3.92	42,1	1.66

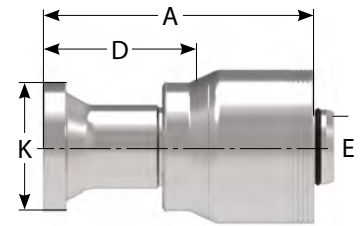

4S

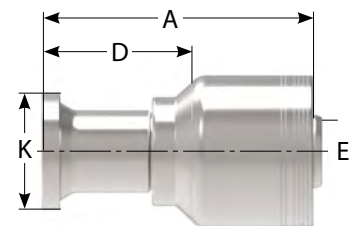

6S

SAE Code 61 Flange (FLA) 45° Elbow

PART		HOSE SIZE INFO				DIMENSIONS							
#	Terminal End	Hose Size		Flange Head Dia. K Ø		A		D		E Ø		H	
1T	Dash Size	DN	Dash Size	mm	in	mm	in	mm	in	mm	in	mm	in
1T8FLA8	-8	12	-8	30,2	1,9	91,7	3,61	58,7	2,31	9	0,35	23	0,91
1T12FLA10	-12	16	-10	38,1	1,50	100,7	3,97	64,1	2,53	12	0,47	25,3	1,00
4S	Dash Size	DN	Dash Size	mm	in	mm	in	mm	in	mm	in	mm	in
4S12FLA12	-12	19	-12	38,1	1,50	113,8	4,48	77,6	3,06	14,2	0,56	27,0	1,06
4S16FLA12	-16	19	-12	44,4	1,75	127,9	5,04	91,7	3,61	14,2	0,56	32,0	1,26
4S12FLA16	-12	25	-16	38,1	1,50	116,9	4,60	77,2	3,04	19,2	0,76	27,0	1,06
4S16FLA16	-16	25	-16	44,4	1,75	131,0	5,16	91,3	3,59	19,2	0,76	32,0	1,26
4S20FLA16	-16	31	-20	44,4	1,75	152,1	5,99	97,0	3,82	25,2	0,99	32,0	1,26
4S16FLA20	-20	25	-16	50,8	2,00	150,2	5,91	110,5	4,35	19,2	0,76	39,0	1,54
4S20FLA20	-20	31	-20	50,8	2,00	166,8	6,57	111,6	4,39	25,2	0,99	39,0	1,54
4S24FLA20	-24	31	-20	60,4	2,38	161,6	6,36	106,6	4,20	25,2	0,99	39,5	1,34
4S24FLA24	-24	38	-24	60,3	2,37	214,3	8,44	136,3	5,37	31,1	1,22	45,0	1,77
4S32FLA24	-32	38	-24	71,4	2,81	251,0	9,88	173,0	6,81	31,1	1,22	57,5	2,26
4S32FLA32	-32	51	-32	71,4	2,81	253,9	10,00	175,9	6,92	42,1	1,66	57,5	2,26
6S	Dash Size	DN	Dash Size	mm	in	mm	in	mm	in	mm	in	mm	in
6S16FLA16	-16	25	-16	44,4	1,75	131,0	5,16	91,3	3,59	19,2	0,76	32,0	1,26
6S20FLA16	-20	25	-16	50,8	2,00	150,2	5,91	110,5	4,35	19,2	0,76	39,0	1,54
6S20FLA20	-20	31	-20	50,8	2,00	167,6	6,60	111,6	4,39	25,2	0,99	39,0	1,54
6S24FLA24	-24	38	-24	60,3	2,37	214,3	8,44	136,3	5,37	31,1	1,22	45,0	1,77
6S32FLA24	-32	38	-24	71,4	2,81	251,0	9,88	173,0	6,81	31,1	1,22	57,5	2,26
6S32FLA32	-32	51	-32	71,4	2,81	253,9	10,00	175,9	6,92	42,1	1,66	57,5	2,26

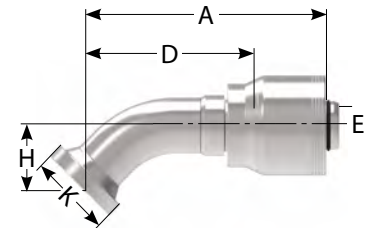

4S

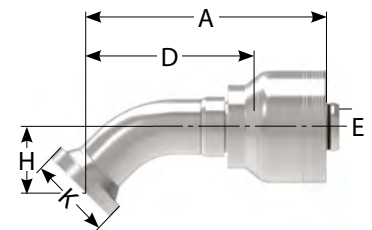

6S

SAE Code 61 Flange (FLB) 90° Elbow

PART		HOSE SIZE INFO				DIMENSIONS							
#	Terminal End	Hose Size		Flange Head Dia. K Ø		A		D		E Ø		H	
	Dash Size	DN	Dash Size	mm	in	mm	in	mm	in	mm	in	mm	in
1T													
1T8FLB8	-8	12	-8	30,2	1.19	83,5	3.29	50	1.97	9	0.35	47	1.58
1T12FLB10	-12	16	-10	38,1	1.50	93,3	3.68	56,7	2.23	12	0.47	53,8	2.12
4S													
4S12FLB12	-12	19	-12	38,1	1.50	108,5	4.27	72,3	2.85	14,2	0.56	59,0	2.32
4S16FLB12	-16	19	-12	44,4	1.75	122,8	4.84	86,6	3.41	14,2	0.56	71,0	2.80
4S20FLB12	-20	19	-12	50,8	2.00	108,5	4.72	72,3	2.85	14,2	0.56	65,0	2.56
4S16FLB16	-16	25	-16	44,4	1.75	126,0	4.96	86,2	3.39	19,2	0.76	71,0	2.80
4S16FLB16.116	-16	25	-16	44,4	1.75	126,0	4.96	86,2	3.39	19,2	0.76	116,0	4.57
4S20FLB16	-20	25	-16	50,8	2.00	145,2	5.72	105,4	4.15	19,2	0.76	89,0	3.50
4S24FLB16	-24	25	-16	60,4	2.38	136,5	5.37	96,8	3.81	19,2	0.76	81,9	3.22
4S16FLB20	-16	31	-20	44,4	1.75	147,1	5.79	91,9	3.62	25,2	0.99	71,0	2.80
4S20FLB20	-20	31	-20	50,8	2.00	161,8	6.37	106,5	4.19	25,2	0.99	89,0	3.50
4S24FLB20	-24	31	-20	60,4	2.38	152,9	6.02	97,9	3.85	25,2	0.99	81,9	3.22
4S24FLB24	-24	38	-24	60,3	2.37	208,9	8.22	130,9	5.15	31,1	1.22	104,0	4.09
4S32FLB24	-32	38	-24	71,4	2.81	247,4	9.74	169,4	6.67	31,1	1.22	138,0	5.43
4S32FLB32	-32	51	-32	71,4	2.81	250,3	9.85	172,2	6.78	42,1	1.66	138,0	5.43
6S													
6S16FLB16	-16	25	-16	44,4	1.75	126,0	4.96	86,2	3.39	19,2	0.76	71,0	2.80
6S20FLB16	-20	25	-16	50,8	2.00	145,2	5.72	105,4	4.15	19,2	0.76	89,0	3.50
6S20FLB20	-20	31	-20	50,8	2.00	162,5	6.40	106,5	4.19	25,2	0.99	89,0	3.50
6S24FLB24	-24	38	-24	60,3	2.37	208,8	8.22	130,8	5.15	31,1	1.22	104,0	4.09
6S32FLB24	-32	38	-24	71,4	2.81	247,4	9.74	169,4	6.67	31,1	1.22	138,0	5.43
6S32FLB32	-32	51	-32	71,4	2.81	250,3	9.85	172,2	6.78	42,1	1.66	138,0	5.43

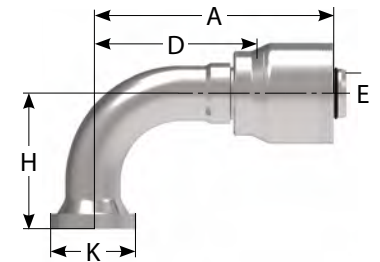

4S

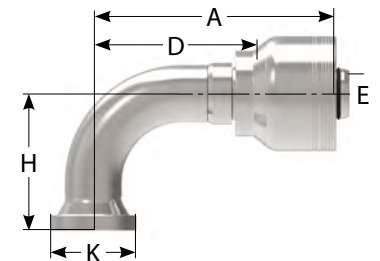

6S

Code 62 Flange

SAE Code 62 Flange (FH) Straight

PART #	HOSE SIZE INFO					DIMENSIONS					
	Terminal End	Hose Size		Flange Head Dia. K Ø		A		D		E Ø	
1T	Dash Size	DN	Dash Size	mm	in	mm	in	mm	in	mm	in
1T8FH8	-8	12	-8	31.8	1.25	80.7	3.18	47.7	1.88	9	0.35
1T12FH8	-12	12	-8	41.3	1.63	84.5	3.33	51.5	2.03	9	0.35
1T8FH10	-8	16	-10	31.8	1.25	87.2	3.44	50.6	1.99	12	0.47
1T12FH10	-12	16	-10	41.3	1.63	90.5	3.57	53.9	2.12	12	0.47
1T16FH10	-16	16	-10	47.6	1.87	104.5	4.11	67.9	2.68	12.1	0.48
4S	Dash Size	DN	Dash Size	mm	in	mm	in	mm	in	mm	in
4S12FH12	-12	19	-12	41,3	1.63	90,7	3.57	54,5	2.15	14,2	0.56
4S16FH12	-16	19	-12	47,7	1.88	90,2	3.55	54,0	2.13	14,2	0.56
4S12FH16	-12	25	-16	41,3	1.63	96,3	3.79	56,7	2.23	14,2	0.56
4S16FH16	-16	25	-16	47,7	1.88	98,9	3.89	59,1	2.33	19,2	0.76
4S20FH16	-20	25	-16	54,0	2.13	100,8	3.97	61,0	2.40	19,2	0.76
4S16FH20	-16	31	-20	47,7	1.88	123,8	4.87	68,6	2.70	25,2	0.99
4S20FH20	-20	31	-20	54,0	2.13	123,3	4.85	68,1	2.68	25,2	0.99
4S24FH20	-24	31	-20	63,5	2.50	129,0	5.08	73,9	2.91	25,2	0.99
4S24FH24	-24	38	-24	63,5	2.50	189,6	7.46	111,6	4.39	31,1	1.22
4S32FH24	-32	38	-24	79,4	3.13	204,4	8.05	126,4	4.89	31,1	1.22
4S32FH32	-32	51	-32	79,4	3.13	202,7	7.98	124,7	4.91	42,1	1.66
6S	Dash Size	DN	Dash Size	mm	in	mm	in	mm	in	mm	in
6S16FH16	-16	25	-16	47,7	1.88	98,8	3.89	59,2	2.33	19,2	0.76
6S20FH16	-20	25	-16	54,0	2.13	100,8	3.97	61,0	2.40	19,2	0.76
6S20FH20	-20	31	-20	54,0	2.13	124,0	4.88	68,1	2.68	25,2	0.99
6S24FH20	-24	31	-20	63,5	2.50	129,8	5.11	73,9	2.91	25,2	0.99
6S24FH24	-24	38	-24	63,5	2.50	189,6	7.46	111,6	4.39	31,1	1.22
6S32FH24	-32	38	-24	79,4	3.13	204,4	8.05	126,4	4.98	31,1	1.22
6S32FH32	-32	51	-32	79,4	3.13	202,7	7.98	124,7	4.91	42,1	1.66

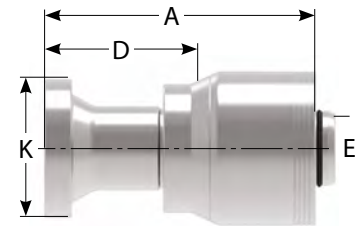

4S

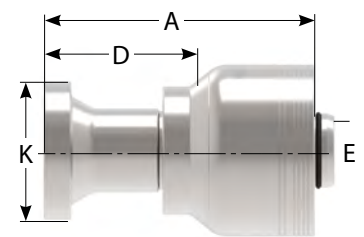

6S

SAE Code 62 Flange (FHA) 45° Elbow

PART		HOSE SIZE INFO				DIMENSIONS							
#	Terminal End	Hose Size		Flange Head Dia. K Ø		A		D		E Ø		H	
1T	Dash Size	DN	Dash Size	mm	in	mm	in	mm	in	mm	in	mm	in
1T8FHA8	-8	12	-8	31,8	1.25	90,1	3.55	57,1	2.25	9	0.35	21,3	0.84
1T12FHA8	-12	12	-8	41,3	1.62	92,8	3.66	59,8	2.36	9	0.35	23,9	0.94
1T8FHA10	-8	16	-10	31,8	1.25	94,1	3.71	57,5	2.27	12	0.47	21,3	0.84
1T12FHA10	-12	16	-10	41,3	1.62	101	3.98	64,4	2.54	12	0.47	25,7	1.01
4S	Dash Size	DN	Dash Size	mm	in	mm	in	mm	in	mm	in	mm	in
4S12FHA12	-12	19	-12	41,3	1.63	113,8	4.48	77,6	3.06	14,2	0.56	27,0	1.06
4S16FHA12	-16	19	-12	47,7	1.88	128,0	5.04	91,7	3.61	14,2	0.56	32,0	1.26
4S12FHA16	-12	25	-16	41,3	1.63	116,9	4.60	77,2	3.04	15,1	0.59	27,0	1.06
4S16FHA16	-16	25	-16	47,7	1.88	130,9	5.15	91,2	3.59	19,2	0.76	32,0	1.26
4S20FHA16	-20	25	-16	54,0	2.13	150,2	5.91	110,5	4.35	19,2	0.76	39,0	1.54
4S20FHA20	-20	31	-20	54,0	2.13	166,6	6.56	111,6	4.39	25,2	0.99	39,0	1.54
4S24FHA20	-24	31	-20	63,5	2.50	183,2	7.21	128,2	5.05	25,2	0.99	45,0	1.77
4S24FHA24	-24	38	-24	63,5	2.50	214,1	8.43	136,1	5.36	31,1	1.22	45,0	1.77
4S32FHA24	-32	38	-24	79,4	3.13	251,0	9.88	173,0	6.81	31,1	1.22	57,5	2.26
4S32FHA32	-32	51	-32	79,4	3.13	253,9	10.00	175,9	6.93	42,1	1.66	57,5	2.26
6S	Dash Size	DN	Dash Size	mm	in	mm	in	mm	in	mm	in	mm	in
6S16FHA16	-16	25	-16	47,7	1.88	130,9	5.15	91,2	3.59	19,2	0.76	32,0	1.26
6S20FHA16	-20	25	-16	54,0	2.13	150,2	5.91	110,0	4.35	19,0	0.75	39,0	1.54
6S20FHA20	-20	31	-20	54,0	2.13	167,6	6.60	111,6	4.39	25,2	0.99	39,0	1.54
6S24FHA20	-24	31	-20	63,5	2.50	184,2	7.25	128,2	5.05	25,2	0.99	45,0	1.77
6S24FHA24	-24	38	-24	63,5	2.50	214,1	8.43	136,1	5.36	31,1	1.22	45,0	1.77
6S32FHA24	-32	38	-24	79,4	3.13	251,0	9.88	173,0	6.81	31,1	1.22	57,5	2.26
6S32FHA32	-32	51	-32	79,4	3.13	253,9	10.00	175,9	6.93	42,1	1.66	57,5	2.26

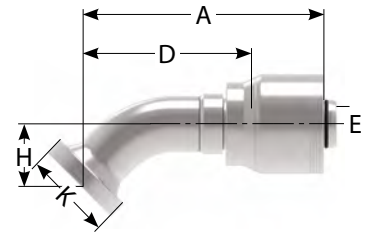

4S

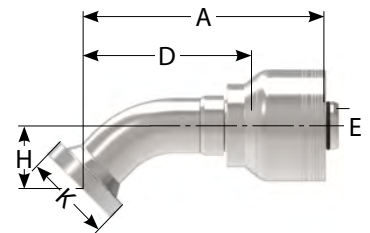

6S

SAE Code 62 Flange (FHB) 90° Elbow

PART		HOSE SIZE INFO				DIMENSIONS							
#	Terminal End	Hose Size		Flange Head Dia. K Ø		A		D		E Ø		H	
1T	Dash Size	DN	Dash Size	mm	in	mm	in	mm	in	mm	in	mm	in
1T8FHB8	-8	12	-8	31,8	1.25	83,5	3.29	50,5	1.99	9	0.35	44,7	1.76
1T12FHB8	-12	12	-8	41,8	1.64	83,5	3.29	50,5	1.99	9	0.35	78	3.07
1T8FHB10	-8	16	-10	31,8	1.25	87,5	3.45	50,9	2.01	12	0.47	44,7	1.76
1T12FHB10	-12	16	-10	41,3	1.62	92,5	3.64	56,5	2.23	12	0.47	53,5	2.11
4S	Dash Size	DN	Dash Size	mm	in	mm	in	mm	in	mm	in	mm	in
4S12FHB12	-12	19	-12	41,3	1.63	108,5	4.27	72,3	2.85	14,2	0.56	59,0	2.32
4S16FHB12	-16	19	-12	47,7	1.88	122,9	4.84	86,6	3.41	14,2	0.56	71,0	2.80
4S16FHB16	-16	25	-16	47,7	1.88	125,5	4.94	86,1	3.39	19,2	0.76	71,0	2.80
4S16FHB16.120	-16	25	-16	47,7	1.88	126,0	4.96	86,2	3.39	19,2	0.76	120,0	4.72
4S20FHB16	-20	25	-16	54,0	2.13	145,3	5.72	105,4	4.15	19,2	0.76	89,0	3.50
4S16FHB20	-16	31	-20	47,7	1.88	147,1	5.79	91,9	3.62	25,2	0.99	71,0	2.80
4S20FHB20	-20	31	-20	54,0	2.13	161,5	6.36	106,5	4.19	25,2	0.99	89,0	3.50
4S20FHB20.120	-20	31	-20	54,0	2.13	161,5	6.36	106,5	4.19	25,2	0.99	120,0	4.72
4S24FHB20	-24	31	-20	63,5	2.50	178,0	7.01	123,0	4.84	25,2	0.99	104,0	4.09
4S24FHB24	-24	38	-24	63,5	2.50	208,9	8.22	130,8	5.15	31,1	1.22	104,0	4.09
4S32FHB24	-32	38	-24	79,4	3.13	247,4	9.74	169,4	6.67	31,1	1.22	138,0	5.43
4S32FHB32	-32	51	-32	79,4	3.13	250,3	9.85	172,2	6.78	42,1	1.66	138,0	5.43
6S	Dash Size	DN	Dash Size	mm	in	mm	in	mm	in	mm	in	mm	in
6S16FHB16	-16	25	-16	47,7	1.88	125,5	4.94	86,1	3.39	19,2	0.76	71,0	2.80
6S20FHB16	-20	25	-16	54,0	2.13	145,3	5.72	105,4	4.15	19,2	0.76	89,0	3.50
6S16FHB20	-16	31	-20	47,7	1.88	147,9	5.82	91,9	3.62	25,2	0.99	71,0	2.80
6S20FHB20	-20	31	-20	54,0	2.13	162,5	6.40	106,5	4.19	25,2	0.99	89,0	3.50
6S24FHB20	-24	31	-20	63,5	2.50	179,0	7.05	123,0	4.84	25,2	0.99	104,0	4.09
6S24FHB24	-24	38	-24	63,5	2.50	208,9	8.22	130,8	5.15	31,1	1.22	104,0	4.09
6S32FHB24	-32	38	-24	79,4	3.13	247,4	9.74	169,4	6.67	31,1	1.22	138,0	5.43
6S32FHB32	-32	51	-32	79,4	3.13	250,3	9.85	172,2	6.78	42,1	1.66	138,0	5.43

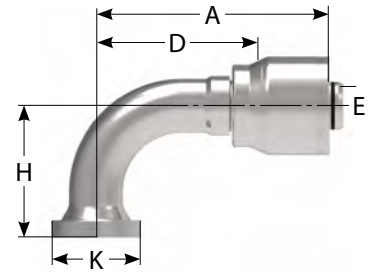

4S

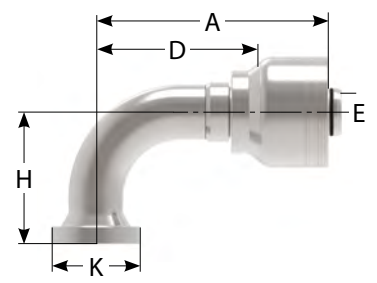

6S

CAT[®] Flange

CAT[®] Flange (CT) Straight

PART		HOSE SIZE INFO				DIMENSIONS					
#	Terminal End	Hose Size		Flange Head Dia. K Ø		A		D		E Ø	
4S	Dash Size	DN	Dash Size	mm	in	mm	in	mm	in	mm	in
4S12CT12	-12	19	-12	41,3	1.63	96,2	3.79	60,0	2.36	14,2	0.56
4S16CT12	-16	19	-12	47,6	1.87	94,9	3.74	58,7	2.31	14,2	0.56
4S16CT16	-16	25	-16	47,6	1.87	102,1	4.02	62,3	2.45	19,2	0.76
4S20CT16	-20	25	-16	54,0	2.13	104,8	4.13	65,0	2.56	19,2	0.76
4S20CT20	-20	31	-20	54,0	2.13	124,5	4.90	69,1	2.72	25,2	0.99
4S24CT20	-24	31	-20	63,5	2.50	130,9	5.15	75,9	2.99	25,2	0.99
4S24CT24	-24	38	-24	63,5	2.50	195,0	7.68	117,0	4.61	31,1	1.22
4S32CT24	-32	38	-24	79,4	3.13	206,0	8.11	128,0	5.04	31,1	1.22
4S32CT32	-32	51	-32	79,4	3.13	208,9	8.22	130,9	5.15	42,1	1.66
6S	Dash Size	DN	Dash Size	mm	in	mm	in	mm	in	mm	in
6S16CT16	-16	25	-16	47,6	1.87	102,1	4.02	62,3	2.45	19,2	0.76
6S20CT16	-20	25	-16	54,0	2.13	104,8	4.13	65,0	2.56	19,2	0.76
6S20CT20	-20	31	-20	54,0	2.13	125,2	4.93	69,1	2.72	25,2	0.99
6S24CT20	-24	31	-20	63,5	2.50	131,8	5.19	75,9	2.99	25,2	0.99
6S24CT24	-24	38	-24	63,5	2.50	195,0	7.68	117,0	4.61	31,1	1.22
6S32CT24	-32	38	-24	79,4	3.13	206,0	8.11	128,1	5.04	31,1	1.22
6S32CT32	-32	51	-32	79,4	3.13	208,9	8.22	130,9	5.15	42,1	1.66

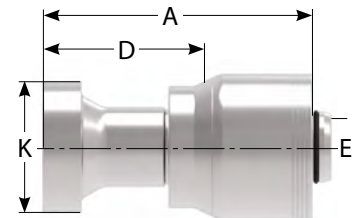

4S

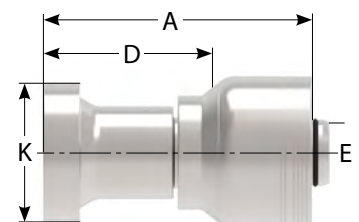

6S

CAT® Flange (CTA) 45° Elbow

PART		HOSE SIZE INFO				DIMENSIONS							
#	Terminal End	Hose Size		Flange Head Dia. K Ø		A		D		E Ø		H	
4S	Dash Size	DN	Dash Size	mm	in	mm	in	mm	in	mm	in	mm	in
4S12CTA12	-12	19	-12	41,3	1,63	117,7	4.63	81,5	3.21	14,2	0.56	30,9	1.22
4S16CTA12	-16	19	-12	47,6	1,87	131,2	5.17	95,0	3.74	14,2	0.56	35,3	1.39
4S16CTA16	-16	25	-16	47,6	1,87	134,3	5.29	94,6	3.72	19,2	0.76	35,3	1.39
4S20CTA16	-20	25	-16	54,0	2,13	153,0	6.02	113,2	4.46	19,2	0.76	41,8	1.65
4S20CTA20	-20	31	-20	54,0	2,13	169,4	6.67	114,3	4.50	25,2	0.99	41,8	1.65
4S24CTA20	-24	31	-20	63,5	2.50	185,3	7.30	129,1	5.08	25,2	0.99	46,2	1.82
4S24CTA24	-24	38	-24	63,5	2.50	215,2	8.47	137,2	5.40	31,1	1.22	46,2	1.82
4S32CTA32	-32	51	-32	79,4	3.13	255,1	10.04	177,0	6.97	42,1	1.66	58,7	2.31
6S	Dash Size	DN	Dash Size	mm	in	mm	in	mm	in	mm	in	mm	in
6S16CTA16	-16	25	-16	47,6	1,87	134,3	5.29	94,6	3.72	19,2	0.76	35,3	1.39
6S20CTA16	-20	25	-16	54,0	2,13	153,0	6.02	113,2	4.46	19,2	0.76	41,8	1.65
6S20CTA20	-20	31	-20	54,0	2,13	170,3	6.70	114,3	4.50	25,2	0.99	41,8	1.65
6S24CTA20	-24	31	-20	63,5	2.50	185,3	7.30	129,1	5.08	25,2	0.99	46,2	1.82
6S24CTA24	-24	38	-24	63,5	2.50	215,2	8.47	137,2	5.40	31,1	1.22	46,2	1.82
6S32CTA24	-32	38	-24	79,4	3.13	252,2	9.93	174,2	6.86	31,1	1.22	58,7	2.31
6S32CTA32	-32	51	-32	79,4	3.13	255,1	10.04	177,0	6.97	42,1	1.66	58,7	2.31

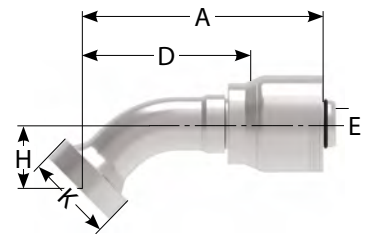

4S

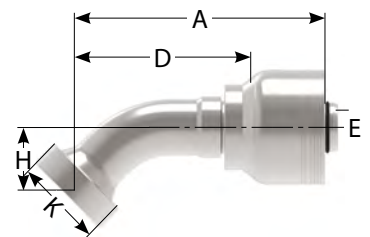

6S

CAT® Flange (CTB) 90° Elbow

PART		HOSE SIZE INFO				DIMENSIONS							
#	Terminal End	Hose Size		Flange Head Dia. K Ø		A		D		E Ø		H	
4S	Dash Size	DN	Dash Size	mm	in	mm	in	mm	in	mm	in	mm	in
4S12CTB12	-12	19	-12	41,3	1.63	108,5	4.27	72,3	2.85	14,2	0.56	64,5	2.54
4S16CTB12	-16	19	-12	47,6	1.87	122,8	4.83	86,6	3.41	14,2	0.56	75,7	2.98
4S16CTB16	-16	25	-16	47,6	1.87	126,0	4.96	86,2	3.39	19,2	0.76	75,7	2.98
4S20CTB16	-20	25	-16	54,0	2.13	145,2	5.72	105,4	4.15	19,2	0.76	92,9	3.66
4S20CTB20	-20	31	-20	54,0	2.13	161,5	6.36	106,5	4.19	25,2	0.99	92,9	3.66
4S24CTB20	-24	31	-20	63,5	2.50	179,0	7.05	123,0	4.84	25,2	0.99	105,6	4.16
4S24CTB24	-24	38	-24	63,5	2.50	208,9	8.22	130,9	5.15	31,1	1.22	105,7	4.16
4S32CTB32	-32	51	-32	79,4	3.13	250,3	9.85	172,2	6.78	42,1	1.66	139,7	5.50
6S	Dash Size	DN	Dash Size	mm	in	mm	in	mm	in	mm	in	mm	in
6S16CTB16	-16	25	-16	47,6	1.87	126,0	4.96	86,2	3.39	19,2	0.76	75,7	2.98
6S20CTB16	-20	25	-16	54,0	2.13	145,2	5.72	105,4	4.15	19,2	0.76	92,9	3.66
6S20CTB20	-20	31	-20	54,0	2.13	162,5	6.40	106,5	4.19	25,2	0.99	92,9	3.66
6S24CTB20	-24	31	-20	63,5	2.50	179,0	7.05	123,0	4.84	25,2	0.99	105,6	4.16
6S24CTB24	-24	38	-24	63,5	2.50	208,9	8.22	130,9	5.15	31,1	1.22	105,7	4.16
6S32CTB24	-32	38	-24	69,6	2.74	247,4	9.74	169,4	6.67	31,1	1.22	139,7	5.50
6S32CTB32	-32	51	-32	79,4	3.13	250,3	9.85	172,2	6.78	42,1	1.66	139,7	5.50

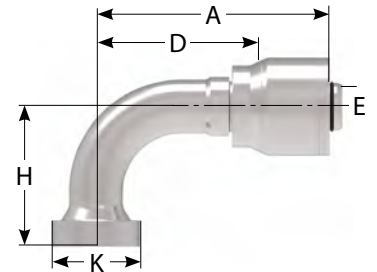

4S

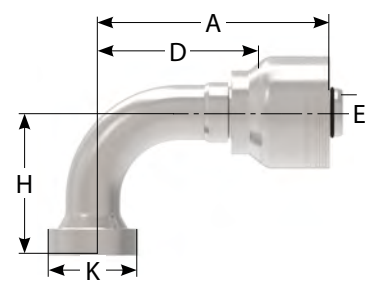

6S



Female JIC/37° Swivel (FJ) Straight

PART		HOSE SIZE INFO			DIMENSIONS							
#	Terminal End	Hose Size		Thread	A		D		E Ø		1	
1T	Dash Size	DN	Dash Size	Metric	mm	in	mm	in	mm	in	mm	in
1T6FJ6	-6	10	-6	9/16-18	47	1.85	17.5	0.69	6.5	0.2561	17	
1T8FJ6	-8	10	-6	3/4-16	49	1.93	19	0.75	6.5	0.2561	22	
1T8FJ8	-8	12	-8	3/4-16	52.5	2.07	19.5	0.77	9	0.3546	22	
1T10FJ8	-10	12	-8	7/8-14	54	2.13	21	0.83	9	0.3546	27	
1T10FJ10	-10	16	-10	7/8-14	59.5	2.34	22.9	0.90	12	0.4728	27	
1T12FJ10	-12	16	-10	1 1/16-12	57	2.25	20	0.79	12	0.4728	32	

PART		HOSE SIZE INFO			DIMENSIONS									
#	Terminal End	Hose Size		Thread	A		D		E Ø		1		1	
4S	Dash Size	DN	Dash Size	Metric	mm	in	mm	in	mm	in	mm	in	mm	in
4S10FJ12	-10	19	-12	7/8-14	75,0	2.95	38,8	1.53	12,3	0.48	30,0	1 3/16	27	
4S12FJ12	-12	19	-12	1 1/16-12	82,0	3.23	45,7	1.80	14,2	0.56	30,0	1 3/16	32	
4S14FJ12	-14	19	-12	1 3/16-12	77,5	3.05	41,3	1.63	14,2	0.56	30,0	1 3/16	36	
4S16FJ12	-16	19	-12	1 5/16-12	80,2	3.16	44,0	1.73	14,2	0.56	30,0	1 3/16	41	
4S12FJ16	-12	25	-16	1 1/16-12	78,8	3.10	39,1	1.54	15,5	0.61	41,0	1 5/8	32	
4S16FJ16	-16	25	-16	1 5/16-12	89,2	3.51	49,3	1.94	19,2	0.76	41,0	1 5/8	41	
4S20FJ16	-20	25	-16	1 5/8-12	85,8	3.38	46,0	1.81	19,2	0.76	41,0	1 5/8	50	
4S16FJ20	-16	31	-20	1 5/16-12	99,1	3.90	43,7	1.72	25,2	0.99	46,0	1 13/16	41	
4S20FJ20	-20	31	-20	1 5/8-12	101,6	4.00	46,3	1.82	25,2	0.99	46,0	1 13/16	50	
4S24FJ20	-24	31	-20	1 7/8-12	106,8	4.20	51,5	2.03	25,2	0.99	46,0	1 13/16	55	
4S24FJ24	-24	38	-24	1 7/8-12	134,9	5.31	56,8	2.24	31,1	1.22	57,0	2 1/4	55	
4S32FJ32	-32	51	-32	2 1/2-12	146,0	5.75	68,0	2.68	42,1	1.66			75	

PART		HOSE SIZE INFO			DIMENSIONS									
#	Terminal End	Hose Size		Thread	A		D		E Ø		1		1	
6S	Dash Size	DN	Dash Size	Metric	mm	in	mm	in	mm	in	mm	in	mm	in
6S16FJ16	-16	25	-16	1 5/16-12	89,2	3.51	49,3	1.94	19,2	0.76	41,0	1 5/8	41	
6S20FJ20	-20	31	-20	1 5/8-12	102,3	4.03	46,3	1.82	25,2	0.99	46,0	1 13/16	50	
6S24FJ20	-24	31	-20	1 7/8-12	107,5	4.23	51,5	2.03	25,2	0.99	46,0	1 13/16	55	
6S24FJ24	-24	38	-24	1 7/8-12	134,9	5.31	56,8	2.24	31,1	1.22	57,0	2 1/4	55	
6S32FJ32	-32	51	-32	2 1/2-12	146,0	5.75	68,0	2.68	42,1	1.66			75	

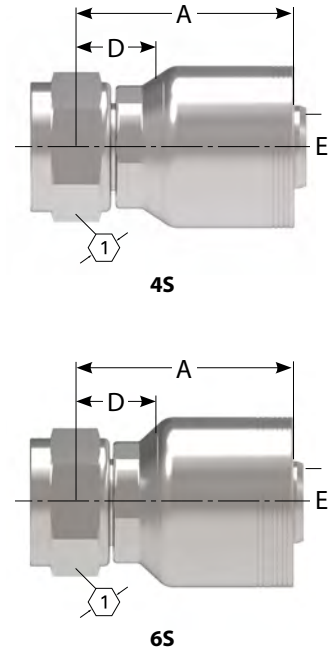

⚠ When assembled with all Danfoss components, all SAE 37° JIC male and female terminal ends in the 4S & 6S product line are rated at the pressures listed in the table above and have passed one million impulse cycles at 133% of this pressure. All straight configurations achieve a 4:1 burst. The 45° and 90° elbow configurations in the -12 size meet a 3.2:1 burst the 45° and 90° elbow configurations in the -16 size achieve a 2.8:1 burst; the 45° and 90° elbow configurations in the -20 size meet a 4:1 burst and the 45° & 90° elbow configurations in the -24 size meet a 2.4:1 burst.

Female JIC/37° Swivel (FJA) 45° Elbow

#	HOSE SIZE INFO				DIMENSIONS								
	Terminal End	Hose Size	Thread		A	D	E Ø	H	1				
1T	Dash Size	DN	Dash Size	Metric	mm	in	mm	in	mm	in	mm	in	mm
1T6FJA6	-6	10	-6	9/16 - 18	64.9	2.56	35.4	1.39	6.6	0.26	13.4	0.53	17
1T8FJA8	-8	12	-8	3/4 - 16	78.2	3.08	45	1.77	9	0.35	19.7	0.78	22
1T10FJA10	-10	16	-10	7/8 - 14	97	3.82	60	2.36	12	0.47	24.5	0.97	27
4S	Dash Size	DN	Dash Size	Metric	mm	in	mm	in	mm	in	mm	in	mm
4S12FJA12	-12	19	-12	1 1/16-12	112,3	4.42	76,1	3.00	14,2	0.56	29,0	1.14	32
4S16FJA12	-16	19	-12	1 5/16-12	133,6	5.26	97,5	3.84	14,2	0.56	38,0	1.50	41
4S16FJA16	-16	25	-16	1 5/16-12	128,8	5.07	89,3	3.52	19,2	0.76	38,0	1.50	41
4S20FJA16	-20	25	-16	1 5/8-12	120,1	4.73	80,4	3.17	19,2	0.75	32,0	1.26	50
4S20FJA20	-20	31	-20	1 5/8-12	135,6	5.34	80,4	3.17	25,2	0.99	32,0	1.26	50
4S24FJA24	-24	38	-24	1 7/8-12	212,0	8.35	134,0	5.28	31,1	1.22	43,0	1.69	55
6S	Dash Size	DN	Dash Size	Metric	mm	in	mm	in	mm	in	mm	in	mm
6S20FJA20	-20	31	-20	1 5/8-12	136,4	5.37	80,4	3.17	25,2	0.99	32,0	1.26	50
6S24FJA24	-24	38	-24	1 7/8-12	212,0	8.35	134,0	5.28	31,1	1.22	43,0	1.69	55

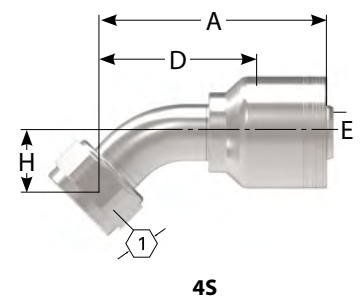
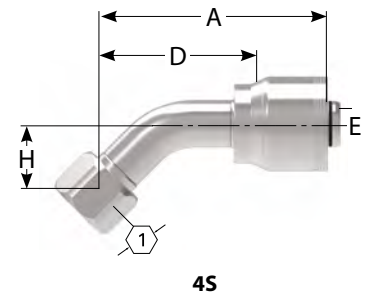

! When assembled with all Danfoss components, all SAE 37o JIC male and female terminal ends in the 4S & 6S product line are rated at the pressures listed in the table above and have passed one million impulse cycles at 133% of this pressure. All straight configurations achieve a 4:1 burst. The 45o and 90o elbow configurations in the -12 size meet a 3.2:1 burst the 45o and 90o elbow configurations in the -16 size achieve a 2.8:1 burst; the 45o and 90o elbow configurations in the -20 size meet a 4:1 burst and the 45o & 90o elbow configurations in the -24 size meet a 2.4:1 burst.

Female JIC/37° Swivel (FJB) 90° Elbow

PART		HOSE SIZE INFO			DIMENSIONS								
#	Terminal End	Hose Size	Thread	A	D	E Ø	H	1					
1T	Dash Size	DN	Dash Size	Metric	mm	in	mm	in	mm	in	mm	in	mm
1T6FJB6	-6	10	-6	9/16 - 18	58	2.29	28.5	1.12	6.5	0.26	25.5	1.00	17
1T8FJB8	-8	12	-8	3/4 - 16	69	2.72	36	1.42	9	0.35	34	1.34	22
1T10FJB10	-10	16	-10	7/8 - 14	87	3.43	46.4	1.83	12	0.47	49	1.93	27
4S	Dash Size	DN	Dash Size	Metric	mm	in	mm	in	mm	in	mm	in	mm
4S12FJB12	-12	19	-12	1 1/16-12	101,3	3.99	65,3	2.57	14,2	0.56	58,0	2.28	32
4S16FJB12	-16	19	-12	1 5/16-12	110,0	4.33	73,8	2.91	14,2	0.56	71,0	2.80	41
4S16FJB16	-16	25	-16	1 5/16-12	113,1	4.45	73,5	2.89	19,2	0.76	71,0	2.80	41
4S20FJB16	-20	25	-16	1 5/8-12	117,1	4.61	77,4	3.05	19,2	0.75	78,0	3.07	50
4S20FJB20	-20	31	-20	1 5/8-12	132,6	5.22	77,4	3.05	25,2	0.99	78,0	3.07	50
4S24FJB24	-24	38	-24	1 7/8-12	208,9	8.22	130,8	5.15	31,1	1.22	104,0	4.09	55
6S	Dash Size	DN	Dash Size	Metric	mm	in	mm	in	mm	in	mm	in	mm
6S16FJB16	-16	25	-16	1 5/16-12	113,1	4.45	73,5	2.89	19,0	0.75	71,0	2.80	41
6S20FJB20	-20	31	-20	1 5/8-12	133,4	5.25	77,4	3.05	25,2	0.99	78,0	3.07	50
6S24FJB24	-24	38	-24	1 7/8-12	208,9	8.22	130,8	5.15	31,1	1.22	104,0	4.09	55

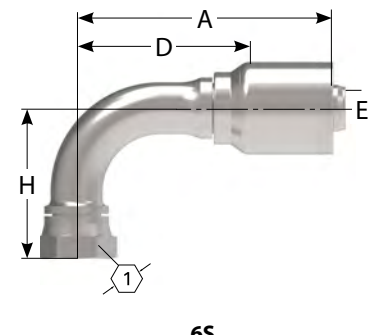
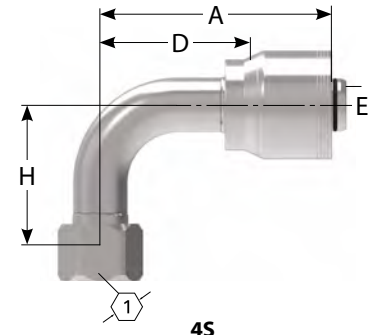

4S

6S

! When assembled with all Danfoss components, all SAE 37o JIC male and female terminal ends in the 4S & 6S product line are rated at the pressures listed in the table above and have passed one million impulse cycles at 133% of this pressure. All straight configurations achieve a 4:1 burst. The 45o and 90o elbow configurations in the -12 size meet a 3.2:1 burst the 45o and 90o elbow configurations in the -16 size achieve a 2.8:1 burst; the 45o and 90o elbow configurations in the -20 size meet a 4:1 burst and the 45o & 90o elbow configurations in the -24 size meet a 2.4:1 burst.

ORS

Female ORS Swivel (FR) Straight

PART		HOSE SIZE INFO			DIMENSIONS								
#	Terminal End	Hose Size	Thread	A	D	E Ø	2	1					
1T	Dash Size	DN	Dash Size	Metric	mm	in	mm	in	mm	in	mm	in	mm
1T6FR6	-6	10	-6	1 1/16- 16	60.5	2.38	31	1.22	6	0.24	22	7/8	19
1T8FR8	-8	12	-8	1 3/16- 16	70.5	2.78	37.5	1.48	9	0.35	24	15/16	22
1T10FR10	-10	16	-10	1 - 14	75.5	2.97	38.9	1.53	12	0.47	30	1 3/16	27
4S	Dash Size	DN	Dash Size	Metric	mm	in	mm	in	mm	in	mm	in	mm
4S10FR12	-10	19	-12	1 - 14	74,4	2.93	38,1	1.50	14,2	0.56	30,0	1 3/16	30
4S12FR12	-12	19	-12	1 3/16-12	77,4	3.05	41,2	1.62	14,2	0.56	30,0	1 3/16	36
4S16FR12	-16	19	-12	1 7/16-12	79,2	3.12	43,1	1.70	14,2	0.56	30,0	1 3/16	41
4S12FR16	-12	25	-16	1 3/16-12	80,5	3.17	40,8	1.61	19,2	0.76	41,0	1 5/8	36
4S16FR16	-16	25	-16	1 7/16-12	82,4	3.24	42,6	1.68	19,2	0.76	41,0	1 5/8	41
4S20FR16	-20	25	-16	1 11/16-12	82,4	3.24	42,7	1.68	19,2	0.76	41,0	1 5/8	50
4S20FR20	-20	31	-20	1 11/16-12	99,0	3.90	43,8	1.72	25,2	0.99	46,0	1 13/16	50
4S24FR24	-24	38	-24	2 - 12	125,7	4.95	47,6	1.87	31,1	1.22	57,0	2 1/4	55
6S	Dash Size	DN	Dash Size	Metric	mm	in	mm	in	mm	in	mm	in	mm
6S16FR16	-16	25	-16	1 7/16-12	82,4	3.24	42,6	1.68	19,2	0.76	41,0	1 5/8	41
6S20FR16	-20	25	-16	1 11/16-12	82,4	3.24	42,7	1.68	19,2	0.76	41,0	1 5/8	50
6S20FR20	-20	31	-20	1 11/16-12	99,8	3.93	43,8	1.72	25,2	0.99	46,0	1 13/16	50
6S24FR24	-24	38	-24	2 - 12	125,7	4.95	47,6	1.87	31,1	1.22	57,0	2 1/4	55

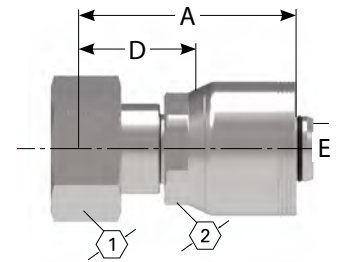

4S

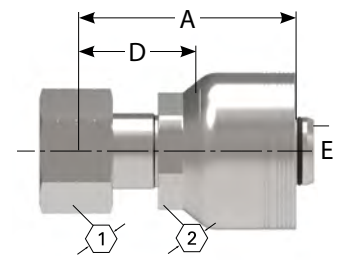

6S

Female ORS Swivel (FRA) 45° Elbow

PART	HOSE SIZE INFO				DIMENSIONS								
#	Terminal End	Hose Size	Thread	A	D	E Ø	H	1					
1T	Dash Size	DN	Dash Size	Metric	mm	in	mm	in	mm	in	mm	in	mm
1T6FRA6	-6	10	-6	11/16-16	65	2.56	35,5	1.40	6	0.24	10,5	0.41	22
1T8FRA8	-8	12	-8	13/16-16	78,5	3.09	45,4	1.79	9	0.35	15	0.59	24
1T10FRA10	-10	16	-10	1-14	85,2	3.36	48,6	1.91	12	0.47	16,4	0.65	30
4S	Dash Size	DN	Dash Size	Metric	mm	in	mm	in	mm	in	mm	in	mm
4S12FRA12	-12	19	-12	1 3/16-12	108,7	4.28	72,5	2.85	14,2	0.56	24,0	0.94	36
4S16FRA12	-16	19	-12	1 7/16-12	119,9	4.72	83,7	3.30	14,2	0.56	28,0	1.10	41
4S16FRA16	-16	25	-16	1 7/16-12	112,8	4.44	73,0	2.87	19,2	0.76	28,0	1.10	41
4S20FRA16	-20	25	-16	1 11/16-12	136,7	5.38	97,0	3.82	19,2	0.76	31,0	1.22	50
4S20FRA20	-20	31	-20	1 11/16-12	153,4	6.04	98,1	3.86	25,2	0.99	31,0	1.22	50
4S24FRA24	-24	38	-24	2-12	212,0	8.35	134,0	5.28	31,1	1.22	43,0	1.69	55
6S	Dash Size	DN	Dash Size	Metric	mm	in	mm	in	mm	in	mm	in	mm
6S16FRA16	-16	25	-16	1 7/16-12	112,8	4.44	73,0	2.87	19,2	0.76	28,0	1.10	41
6S20FRA16	-20	25	-16	1 11/16-12	136,7	5.38	97,0	3.82	19,2	0.76	31,0	1.22	50
6S20FRA20	-20	31	-20	1 11/16-12	154,1	6.07	98,1	3.86	25,2	0.99	31,0	1.22	50
6S24FRA24	-24	38	-24	2-12	212,0	8.35	134,0	5.28	31,1	1.22	43,0	1.69	55

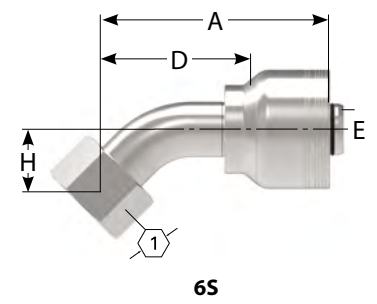
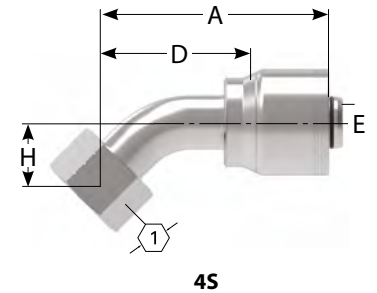

Female ORS Swivel (FRB) 90° Elbow

#	PART	HOSE SIZE INFO			DIMENSIONS									
		Terminal End	Hose Size	Thread	A		D		E Ø		H			
	1T	Dash Size	DN	Dash Size	Metric	mm	in	mm	in	mm	in	mm	in	mm
	1T6FRB6	-6	10	-6	1 3/16-16	61,9	2,44	32,4	1,28	6,5	0,26	22,4	0,88	22
	1T8FRB8	-8	12	-8	1 3/16-16	71,7	2,82	38,7	1,52	9	0,35	29,1	1,15	24
	1T10FRB10	-10	16	-10	1-14	77,8	3,07	41,2	1,62	12	0,47	32,2	1,27	30
	4S	Dash Size	DN	Dash Size	Metric	mm	in	mm	in	mm	in	mm	in	mm
	4S10FRB12	-10	19	-12	1-14	91,5	3,60	55,3	2,18	14,2	0,56	32,3	1,27	30
	4S12FRB12	-12	19	-12	1 3/16-12	104,4	4,11	68,1	2,68	14,2	0,56	58,0	2,28	36
	4S16FRB12	-16	19	-12	1 7/16-12	117,1	4,61	80,9	3,19	14,2	0,56	71,0	2,80	41
	4S12FRB16	-12	25	-16	1 3/16-12	107,5	4,23	67,7	2,67	19,2	0,76	58,0	2,28	36
	4S16FRB16	-16	25	-16	1 7/16-12	112,8	4,44	73,0	2,87	19,2	0,76	71,0	2,80	41
	4S20FRB16	-20	25	-16	1 11/16-12	136,5	5,37	96,8	3,81	19,2	0,76	78,0	3,07	50
	4S20FRB20	-20	31	-20	1 11/16-12	153,1	6,03	97,9	3,85	25,2	0,99	78,0	3,07	50
	4S24FRB20	-24	31	-20	2-12	152,9	6,02	97,9	3,85	25,2	0,99	86,0	3,39	55
	4S24FRB24	-24	38	-24	2-12	208,9	8,22	130,8	5,15	31,1	1,22	104,0	4,09	55
	6S	Dash Size	DN	Dash Size	Metric	mm	in	mm	in	mm	in	mm	in	mm
	6S16FRB16	-16	25	-16	1 7/16-12	112,8	4,44	73,0	2,87	19,2	0,76	71,0	2,80	41
	6S20FRB16	-20	25	-16	1 11/16-12	136,5	5,37	96,8	3,81	19,2	0,76	78,0	3,07	50
	6S20FRB20	-20	31	-20	1 11/16-12	153,9	6,06	97,9	3,85	25,2	0,99	78,0	3,07	50
	6S24FRB24	-24	38	-24	2-12	208,9	8,22	130,8	5,15	31,1	1,22	104,0	4,09	55

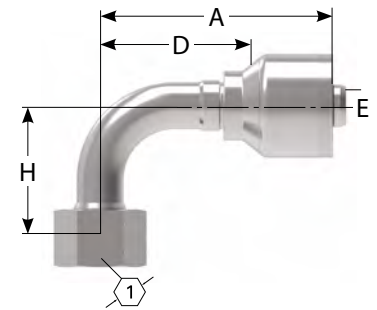

4S

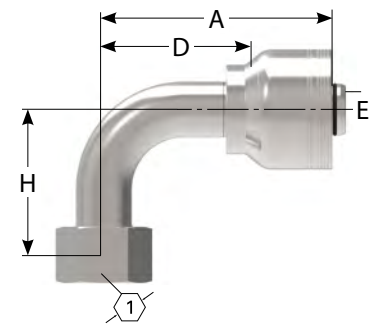

6S

BSP 60° Cone

BSP Male Parallel Rigid (BP) 60° Cone Seat, Straight

PART		HOSE SIZE INFO			DIMENSIONS						
#	Terminal End	Hose Size	Thread	A		D		E Ø		1	
1T	Dash Size	DN	Dash Size	Metric	mm	in	mm	in	mm	in	mm
1T6BP6	-6	10	-8	G 3/8"	55	2.17	25.5	1.00	6.5	0.26	19
1T8BP8	-8	12	-8	G 1/2"	61	2.40	28	1.10	9	0.35	22
1T10BP10	10	16	10	G 5/8"	68	2.68	27.4	1.08	12	0.47	27
4S	Dash Size	DN	Dash Size	Metric	mm	in	mm	in	mm	in	mm
4S12BP12	-12	19	-12	G 3/4-14	79,6	3.13	43,4	1.71	14,2	0.56	32,0
4S16BP16	-16	25	-16	G 1-11	89,8	3.53	50,1	1.97	19,2	0.75	41,0
4S20BP20	-20	31	-20	G 1 1/4-11	109,7	4.32	54,5	2.15	25,1	0.99	50,0

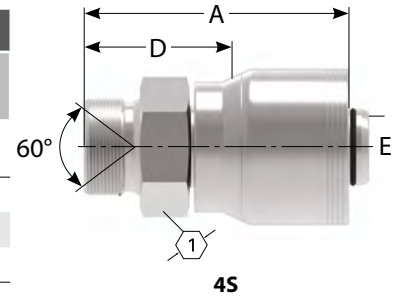

"G" as part of thread size is ISO designation for parallel thread.

BSP Female Parallel Rigid (BF) 60° Cone Seat, Straight

PART		HOSE SIZE INFO			DIMENSIONS						
#	Terminal End	Hose Size	Thread	A	D	E Ø		1			
1T	Dash Size	DN	Dash Size	Metric	mm	in	mm	in	mm	in	mm
1T6BF6	-6	10	-6	G 3/8"	50	1.97	20.5	0.81	6.5	0.26	22
1T8BF8	-8	12	-8	G 1/2"	55.5	2.19	22.5	0.89	9	0.35	27
1T10BF10	-10	16	-10	G 5/8"	60	2.36	23.5	0.93	12	0.47	27
4S	Dash Size	DN	Dash Size	Metric	mm	in	mm	in	mm	in	mm
4S12BF12	-12	19	-12	G 3/4-14	66,2	2.61	29,9	1.18	14,2	0.56	32,0
4S16BF12	-16	19	-12	G 1-11	68,7	2.70	32,3	1.27	14,2	0.56	41,0
4S16BF16	-16	25	-16	G 1-11	71,0	2.80	32,3	1.27	19,2	0.76	41,0
4S20BF16	-20	25	-16	G 1 1/4-11	72,5	2.85	32,7	1.29	19,2	0.76	50,0
4S20BF20	-20	31	-20	G 1 1/4-11	82,8	3.26	32,7	1.29	25,2	0.99	50,0
4S24BF24	-24	38	-24	G 1 1/2-11	117,9	4.64	39,8	1.57	31,1	1.22	55,0
4S32BF32	-32	51	-32	G 2-11	121,0	4.76	43,0	1.69	42,1	1.66	70,0
6S	Dash Size	DN	Dash Size	Metric	mm	in	mm	in	mm	in	mm
6S24BF24	-24	38	-24	G 1 1/2-11	117,9	4.64	39,8	1.57	31,1	1.22	55,0
6S32BF32	-32	51	-32	G 2-11	121,0	4.76	43,0	1.69	42,1	1.66	70,0

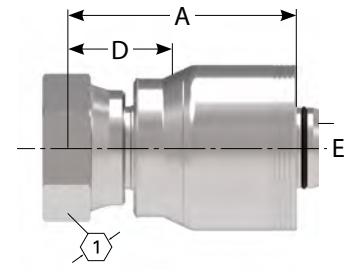

4S

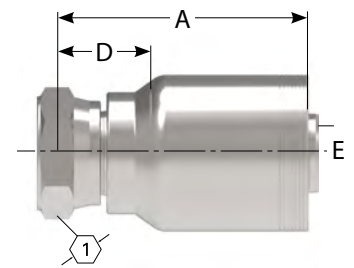

6S

"G" as part of thread size is ISO designation for parallel thread.

Female BSPP Swivel (BFA) 60° Cone Seat, 45° Elbow

PART		HOSE SIZE INFO			DIMENSIONS								
#	Terminal End	Hose Size	Thread	A	D	E Ø	H	1					
1T	Dash Size	DN	Dash Size	Metric	mm	in	mm	in	mm	in	mm	in	mm
1T6BFA6	-6	10	-6	G 3/8"	68	2.68	38,5	1.52	6	0.24	14	0.55	22
1T8BFA8	-8	12	-8	G 1/2"	74	2.92	41	1.62	9	0.35	15	0.59	27
1T10BFA10	-10	16	-10	G 5/8"	80	3.15	43	1.69	12	0.47	16,5	0.65	30
4S	Dash Size	DN	Dash Size	Metric	mm	in	mm	in	mm	in	mm	in	mm
4S12BFA12	-12	19	-12	G 3/4-14	112,3	4.42	75,9	2.99	14,2	0.56	26,0	1.02	32,0
4S16BFA12	-16	19	-12	G 1-11	115,8	4.56	79,5	3.13	14,2	0.56	30,0	1.18	41,0
4S16BFA16	-16	25	-16	G 1-11	130,3	5.13	90,6	3.57	19,2	0.76	30,0	1.18	41,0
4S20BFA16	-20	25	-16	G 1 1/4-11	133,0	5.24	93,4	3.68	19,2	0.76	34,0	1.34	50,0
4S20BFA20	-20	31	-20	G 1 1/4-11	149,5	5.89	99,1	3.90	25,2	0.99	34,0	1.34	50,0
4S24BFA24	-24	38	-24	G 1 1/2-11	208,3	8.20	130,3	5.13	31,1	1.22	42,4	1.67	55,0
4S32BFA32	-32	51	-32	G 2-11	248,4	9.78	170,4	6.71	42,1	1.66	54,1	2.13	70,0
6S	Dash Size	DN	Dash Size	Metric	mm	in	mm	in	mm	in	mm	in	mm
6S24BFA24	-24	38	-24	G 1 1/2-11	208,3	8.20	130,3	5.13	31,1	1.22	42,4	1.67	55,0
6S32BFA32	-32	51	-32	G 2-11	248,4	9.78	170,4	6.71	42,1	1.66	54,1	2.13	70,0

"G" as part of thread size is ISO designation for parallel thread.

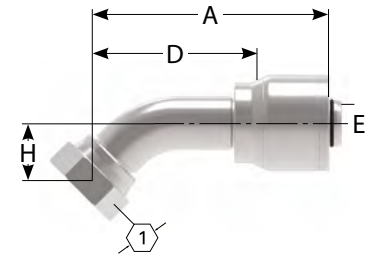

4S

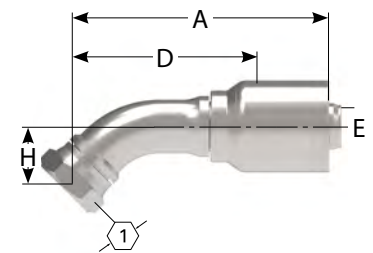

6S

Female BSPP Swivel (BFB) 60° Cone Seat, 90° Elbow

PART		HOSE SIZE INFO			DIMENSIONS								
#	Terminal End	Hose Size	Thread	A	D	E Ø	H	1					
1T	Dash Size	DN	Dash Size	Metric	mm	in	mm	in	mm	in	mm	in	mm
1T6BFB6	-6	10	-6	G 3/8"	62	2.44	32.4	1.28	6.5	0.26	28	1.10	22
1T8BFB8	-8	12	-8	G 1/2"	69.5	2.74	36.5	1.44	9	0.35	32	1.26	27
1T10BFB10	-10	16	-10	G 5/8"	76.5	3.01	39	1.54	12	0.47	36	1.42	27
4S	Dash Size	DN	Dash Size	Metric	mm	in	mm	in	mm	in	mm	in	mm
4S12BFB12	-12	19	-12	G 3/4-14	105,9	4.17	69,6	2.74	14,2	0.56	57,0	2.24	32,0
4S16BFB12	-16	19	-12	G 1-11	105,9	4.17	69,6	2.74	14,2	0.56	68,0	2.68	41,0
4S16BFB16	-16	25	-16	G 1-11	125,5	4.94	85,8	3.38	19,2	0.76	68,0	2.68	41,0
4S20BFB16	-20	25	-16	G 1 1/4-11	125,5	4.94	85,8	3.38	19,2	0.76	79,0	3.11	50,0
4S20BFB20	-20	31	-20	G 1 1/4-11	145,0	5.71	95,0	3.74	25,2	0.99	79,0	3.11	50,0
4S24BFB24	-24	38	-24	G 1 1/2-11	205,1	8.07	127,0	5.00	31,1	1.22	98,6	3.88	55,0
4S32BFB32	-32	51	-32	G 2-11	245,7	9.67	167,6	6.60	42,1	1.66	125,3	4.93	70,0
6S	Dash Size	DN	Dash Size	Metric	mm	in	mm	in	mm	in	mm	in	mm
6S24BFB24	-24	38	-24	G 1 1/2-11	205,1	8.07	127,0	5.00	31,1	1.22	98,6	3.88	55,0
6S32BFB32	-32	51	-32	G 2-11	245,7	9.67	167,6	6.60	42,1	1.66	125,3	4.93	70,0

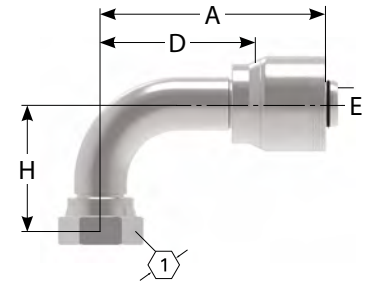

4S

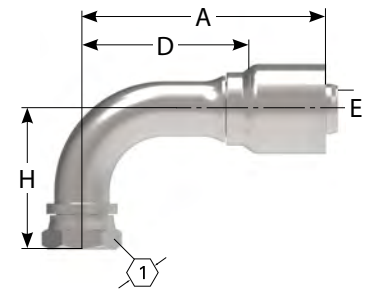

6S

About Danfoss Power Solutions

Danfoss Power Solutions is a global manufacturer and supplier of high-quality hydraulic and electric components. We specialize in providing state-of-the-art technology and solutions that excel in the harsh operating conditions of the mobile off-highway market as well as the marine sector. Building on our extensive applications expertise, we work closely with you to ensure exceptional performance for a broad range of applications. We help you and other customers around the world speed up system development, reduce costs and bring vehicles and vessels to market faster.

We offer you expert worldwide support for ensuring the best possible solutions for outstanding performance. And with an extensive network of Global Service Partners, we also provide you with comprehensive global service for all of our components.

Danfoss Power Solutions – your strongest partner in mobile hydraulics and mobile electrification.

Products we offer:

- Aeroquip by Danfoss
- Boston by Danfoss
- DCV directional control valves
- Electric converters
- Electric machines
- Electric motors
- Hydrostatic motors
- Hydrostatic pumps
- Orbital motors
- PLUS+1® controllers
- PLUS+1® displays
- PLUS+1® joysticks and pedals
- PLUS+1® operator interfaces
- PLUS+1® sensors
- PLUS+1® software services, support and training
- PLUS+1® software
- Position controls and sensors
- PVG proportional valves
- SEL by Danfoss
- Steering components and systems
- Synflex Optimum by Danfoss
- Telematics
- Weatherhead by Danfoss
- Winner by Danfoss

Go to www.danfoss.com for further product information.

Danfoss Power Solutions (US) Company

2800 East 13th Street
Ames, IA 50010, USA
Phone: +1 515 239 6000

Danfoss Power Solutions ApS

Nordborgvej 81
DK-6430 Nordborg, Denmark
Phone: +45 7488 2222

Danfoss Power Solutions GmbH & Co. OHG

Krokamp 35
D-24539 Neumünster, Germany
Phone: +49 4321 871 0

Danfoss Power Solutions Trading (Shanghai) Co. Ltd.

Building #22, No. 1000 Jin Hai Rd
Jin Qiao, Pudong New District
Shanghai, China 201206
Phone: +86 21 3418 5200