

Installation Guide

DEVIreg™ Basic

Intelligent electronic timer-controlled Floor thermostat
with App control

DEVI 
by Danfoss

Make it easy,
make it DEVI



Table of contents

1	Introduction	4
2	Standard Compliance	5
3	Safety instruction	6
4	Installation Guidelines	8
5	User Guide	17
	DEVI Control App	25
	DEVI Control App User Guide	25
6	Eco Design Sheet	29
7	Warranty	33
8	Disposal instruction	36

1 Introduction

The DEVIreg™ Basic is an electrical floor heating thermostat with adaptive timer support which provides an efficient way to control your electrical floor heating system by floor temperature.

The thermostat is special designed for wall mounted installation in standard EU wall mount boxes, in and on wall, and can be used for control of total heating as well as comfort heating of the room. The thermostat supports a selection of commonly used frame systems for 55x55 (inner geometry) framing systems.

Among others, the thermostat has the following features:

- ECO design LOT20 compliance
- In App setup for specific flooring and room types.
- Support for 55x55 like frame systems.
- Simple knob operation for temp. control and features.
- Bluetooth connectivity on 2.4 GHz frequency at a maximum power of 10 dBm.
- Access to thermostat via App for settings for easy access, setup, or remote troubleshooting. Firmware update via DEVI Control App.
- Works out of box with default parameters as thermostat.

2 Standard Compliance

Electrical safety, Electro-Magnetic Compatibility and Radio aspects for this product is covered by the compliance with the following relevant standards:

- EN/IEC 60730-1 (general)
- EN/IEC 60730-2-7 (timer)
- EN/IEC 60730-2-9 (thermostat)
- EN 301 349-1 and EN 301 349-17 (EMC standard for radio equipment operating in the 2,4 GHz band)
- EN 300 328 (Efficient use of radio spectrum for radio equipment operating in the 2,4 GHz band)

SIMPLIFIED EU DECLARATION OF CONFORMITY

Hereby, Danfoss A/S declares that the radio equipment DEVIreg™ Basic is in compliance with Directive 2014/53/EU.

The full Declaration of conformity can be found on

<https://assets.danfoss.com/approvals/latest/281716/ID455643625457-0101.pdf>

3 **Safety instruction**

Make sure that the mains power supply to the thermostat is shut off before starting the installation.

Important: When the thermostat is used to control a floor heating element, always use a floor sensor, and never set the maximum floor temperature to more than the manufacturer recommends for the specific flooring type. The device is limited to 35 °C floor temperature, due to compliance requirements. In special cases the limit can be extended to 45 °C floor temperature after the unrecoverable breakout has been performed. Based on the setup in the app the thermostat has maximum temperature limitations imposed based on our recommendations.

- Electrical heating thermostats must always be installed according to local building regulations and wiring rules. Installation must be carried out by an authorized and/or qualified installer.
- The thermostat must be used in a wall mounted installation supplied through an all-pole disconnection switch (fuse).
- Do not expose the thermostat/switch to moisture, water, dust, and excessive heat.
- This thermostat/switch can be used by children aged from 8 years and above and persons with reduced physical, sensory or mental capabilities or lack of experience and knowledge, if they have been given supervision or instruction concerning use of the appliance in a safe way and understand the hazards involved, by a person responsible for their safety.
- Children should be supervised to ensure that they do not play with the thermostat/switch.
- The device is designed for permanent operation.

Instructional video material

To make it easy we show the features and functions of the product in videos that are present on our YouTube channel.



4 Installation Guidelines

Follow these guidelines when placing the thermostat for optimal user experience of the thermal control.



Install the sensor more than 50 cm from window and door openings.



The thermostat must not be installed in direct wet areas (Zones 0, 1 and 2). Always follow local regulations regarding IP classes, this doesn't mean that the thermostats can't be installed in bathrooms.



Install the thermostat more than 50 cm from window and door openings.

Installation steps

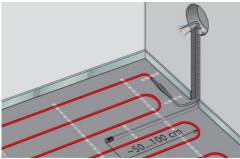
Description	Illustration
<p>1. Unpack the thermostat. Make sure all parts are delivered (1 pc. thermostat unit ,1 pc. Power supply, 1 pc. Frame, and 1 pc. wire sensor) along with the instructions written in local official language.</p>	
<p>2. Place the floor sensor in the Flexpipe and make sure the sensor element is properly fixed inside a Flexpipe. The Flexpipe must guide the sensor cable all the way to the wall/connection box. Our mats have this product included. sold separately as (140F1114).</p>	

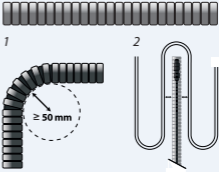
Description	Illustration
<p>3. The bending radius for the Flexpipe must be more than 50 mm.</p> <p>4. Make sure the floor sensor is located with equal distances between two heating cables (> 2 cm) located at a representative position.</p> <p>5. For thin floor constructions: the Flexpipe should be flush with the sub-floor surface, countersink the Flexpipe if possible. For thicker constructions: the Flexpipe including the sensor should be located such that the sensor is exposed to a representative heating level, our recommendation is still that the sensor is located equidistant between the cables or mat runs.</p>	 <p>The illustration consists of three parts. At the top, a horizontal row of 15 grey rectangular heating cables is shown. Below this, on the left, is a 90-degree bend of the heating cables. A dashed circle indicates the bending radius, with an arrow pointing to it and the text ≥ 50 mm. On the right, a vertical U-shaped layout of the heating cables is shown, with a floor sensor (a vertical rod with a circular head) positioned between the two vertical legs of the U-shape.</p>

Description

6. Ensure that the wiring circuit is disconnected and voltage free, turn off the all-pole disconnect.
7. Connect the wires according to the wiring diagram on back of the power supply of the thermostat. Ensure that the terminals are properly fastened and wires are securely connected.

Illustration

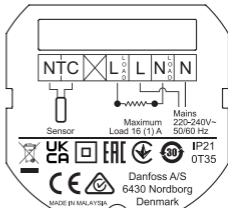

8. The screen/PE wire from the electric heating element must be connected to the PE wire from the main power supply using a separate connector.

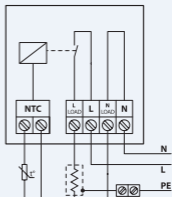

Description

Illustration

9. Fasten the thermostat's power supply to the wall terminal box using screws in minimum 2 of the designated holes on the power supply unit.
Notice: place the thermostat according to the  - arrow

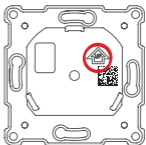

10. Attach the frame and the Top frame to the thermostat. After that attach the thermostat to the Power supply unit by a softly press until all parts firmly connected.
11. Carefully attach the thermostat to the Power supply – take care that the connector pins are not bent.

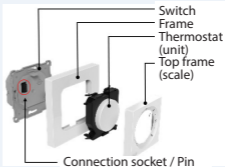

12. After electrical installation is completed, turn on the all-pole disconnect (fuse).

Description	Illustration
13. The thermostat is now ready for use.	The thermostat does not require any settings to be performed in the app, however this will be required to modify advanced features, schedules and more.
14. Dismount thermostat front for replacement.	Perform steps 11 and 10 carefully in the mentioned order, detachment can be done without tools or with a flathead screwdriver.

Connection scheme

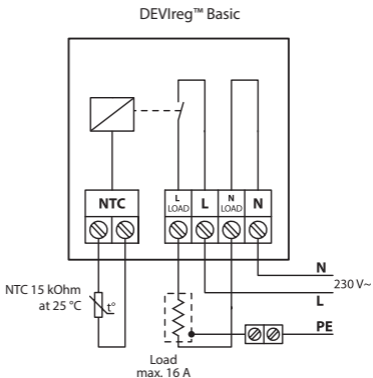

Technical specifications

Operating voltage	220-240 V~, 50/60 Hz
Power consumption	OFF: <175 mW Idle: <200 mW
Contact rating: - Resistive load - Inductive load	230 V ~ 16 A/3680 W Cos φ = 0,3 max. 1 A
Floor sensor	NTC 15 k Ω @ 25 °C, 3 m. (default)*
Control	PWM (Pulse Width Modulation)
Temperature control range	Floor temperature: 5 °C to 35 °C (45 °C after breakout)
Ambient temperature range	0 °C to 35 °C
Frost protection	4 °C to 14 °C (default value 5 °C)
IP class	21
Protection class	Class II - 
Maximum cable size	1 x 4 mm ² or 2 x 2,5 mm ² /terminal
Controller type	1B
Software class	A
Pollution degree	2 (Domestic use)
Over voltage category	III

Temperature for Ball pressure test	75 °C
Storage temperature	-25 °C to 60 °C
Timer functions	3 periods per day. Resolution of timer is 30 minutes.
Dimensions	85 mm x 85 mm x 20-24 mm (in wall depth: 22 mm)
Weight	194 g



* standard DEVI sensor 140F1091 3m.

5 User Guide

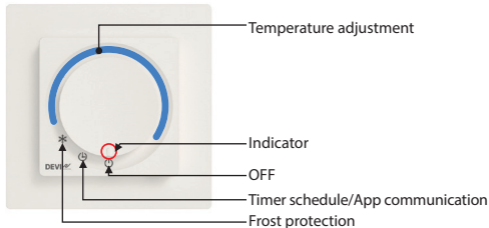
Product interface



** When knob is in temp adjustment mode the thermostat will not run the time schedule program.*

Knob position	Description
OFF 	In this position the thermostat is not active.
Timer schedule / App communication 	In this position the thermostat is running in schedule mode. In this position the thermostat is ready for App configuration/modification.
Frost protection 	In this position the thermostat is operating in frost protection mode.
Temp adjustment	By turning the knob clockwise the temperature will increase (1..6)

User interface/ daily use

On the thermostat the temperature can be directly adjusted using the knob/dial by setting the indicator on the wanted floor temperature, this will disregard any schedule, however, still adhere to any set min/max limitations (can be set in the app).

The positions Frost protection, Timer schedule or OFF can be selected using the knob/dial.

Selecting the Frost protection mode will see the thermostat ensure that the frost temperature is maintained, this value can be set between 4-14 °C (default 5 °C) in the app.

Selecting the timer schedule / app communication mode the device will be connectable in the DEVI control app, the communication is done via Bluetooth 4.2, where temperatures, settings, schedule, limits and more can be set to the desired level.

Selecting the OFF mode will disable the thermostat completely.

When the thermostat is in all other positions than Timer schedule/App communication the app can only display limited information, in OFF the app and thermostat will be completely OFF and nothing will be indicated or communicated to the app.

To pair the thermostat with the app, place the thermostat in the App communication position and start the process in the app, the device will blink with the communication indicator. After the app has initiated the communication with the thermostat, the user needs to turn the dial out to manual temperature setting and back into the App communication position, this is to validate with what thermostat the pairing is wanted.

Dial setting	Approximate temperature	W. Breakout*
1	15	15
2	22	25
3	25	30
4	28	35
5	32	40
6	35	45

* Temperatures above are the temperatures that can be expected at the floor sensor location.
Do not use breakout with thin heating mats.

Indicators

The indicators are shine through and are within the knob of the product, these will light up when needed.



Indicators
(inside the knob)

All indicators fade out after a duration (default 20 seconds) unless an error is present. Additionally, indicators will “wake up” upon manual interaction with the thermostat, heating state change, schedule event, app connection or errors/warnings appearing.

Heat indicator

- This indicator lights up and turns **red** when the thermostat switches **on** and delivers current to the electric heating element. After some seconds the indicator fades out.
- This indicator lights up and turns **green** when the thermostat is powered and OK. After some seconds the indicator fades out.
- The indicator flashes **red** when an error is present, this will persist until error is alleviated, heating will not be activated/activatable.

Data communication

- This indicator flashes **white** when initiating data communication between the thermostat and communication device unit.
- The indicator flashes in part of the pairing process
- The indicator is constant lightning **white** when communication between the thermostat and communication device is present. The indicator turns off when communication stops.

Schedule



- This indicator lights up **white** when the built in schedule changes from Non active to active and vice versa. After some seconds, the indicator fades out.
- The indicator flashes in part of the paring process.
- This indicator flashes **white** when there are warnings. The warning will be present until App communication is activated, however the indicator will only flash for a duration (default 20 seconds). Warnings will be displayed in the App.

Default settings and out of the box settings.

The DEVIreg™ Basic will have the following settings out of the box:

Maximum floor temperature: 28 °C

Minimum floor temperature 5 °C

If the thermostat is placed onto the schedule (clock) icon without having the app connected, the temperature is default 25 °C

Factory reset

To perform a factory reset the thermostat needs to be powered and correctly mounted, on the bottom of the device (circled below) is a pin hole, by pressing a needle into this pinhole a button will be activated, after 20-30 seconds of activation of this button the thermostat will perform a factory reset. All indicators will flash briefly to inform about successful factory reset.

The thermostat will briefly be rebooting please allow for up to 5 seconds for the thermostat to be back to a responsive state.

Performing a factory reset will reset errors and warnings.

Alternative method, the front cover on the thermostat can be removed using the slot on the bottom of the thermostat and the button can be activated with a finger or similar.

The factory reset can only be performed whilst the thermostat is powered.



Breakout

To enable the thermostat to go up to a floor temperature of 45 °C a permanent modification must be made, this can invalidate your warranty on the product and connected products.

The higher maximum temperature limit needs to be set in the app after the action has been performed.

To best perform the action the thermostat unit needs to be dismantled from the power supply, on the back of the thermostat there is a hole as shown below, to perform the breakout the plastic seal in the hole needs to be broken and thereafter the PCB trace needs to be broken. The action is best performed with a flathead screwdriver or similar as shown below.

whilst doing the breakout please take care not to damage any other components on the circuit board.



DEVI Control App:***DEVI Control App User Guide:*****REFERENCE TO APP MANUAL**

To pair the thermostat with the app, initiate the app and follow the instructions provided in the app.

App enabled functions

- wizard assisted installation
- scheduling
- pre-heating (adaptive heating)
- thermostat limits adaptation
- child lock
- settings lock
- warning and error readout
- information export
- help function
- complete overview of data and functions

Warnings and error messages

Warning table

Warning	Description	Reference
W1	Schedule overwritten due to manual dial setting	Set when Schedule is active (Set in App) but dial has been turned to set a manual setpoint
W2	Invalid clock	If time is totally invalid - less than 2021 or above 2050 or use production date or first time connected to App
W3	Child lock is enable	Will be active if child lock is enable and the user tries to change the setpoint or mode with the potentiometer (or encoder)
W5	Set temperature not achievable	Warning given when the room/floor temperature from schedule or manual setpoint can't be reached within 40 PWM periods (Output from heating control)
W8	Maximum Floor Temperature Limit reached	Set if Maximum Floor Temperature is reached while in Combi Mode while Room Temperature is not at Set point
W10	Temperature set above maximum temperature limit	Set, if maximum temperature is lower than the current temperature knob/potentiometer is pointing at. Like Max set to 25°C and knob is set to 27°C

Error table

Error type	No	Description	Solution	Need restart
Floor Sensor disconnected	E1	Connection to sensor is lost	Contact installer or local Danfoss service	The thermostat requires a restart to operate again
Floor Sensor short-circuited	E2	Sensor short-circuited	Contact installer or local Danfoss service	The thermostat requires a restart to operate again
Thermostat overheated	E3	Thermostat is overheated, heating is turned off.	Wait until thermostat cools down	The thermostat needs no restart but will start heating when the temperature is lowered
Room sensor disconnected	E4	Room temperature sensor value too low.	Contact installer or local Danfoss service	Not Applicable for DEVireg Basic
Room sensor short-circuited	E5	Room temperature sensor value too high.	Contact installer or local Danfoss service	Not Applicable for DEVireg Basic

Error type	No	Description	Solution	Need restart
Unrecoverable error, Power supply	E6	Power supply is detected as defective	Contact installer or local Danfoss service	
Potentiometer / dial error	E9	Potentiometer is detected as defective	Contact installer or local Danfoss service	The potentiometer is reading a value that is outside of the given range
Invalid communication	E10	Bluetooth communication error	Retry / Contact installer or local Danfoss service	Bluetooth communication has encountered an unexpected / faulty command
Unrecoverable error	E11	Unrecoverable error	Contact installer or local Danfoss service	

Factory reset will reset all errors and warnings.

6 Eco Design Sheet

To comply with ECO design regulations for electric local space heaters 1188/2015 the following table is to be filled in with the specifics of the heating system. Herein the thermostat information for this specific product is prefilled, please fill any/all blank slots.

Information requirements for electric local space heaters

Model identifier(s): DEVIreg™ Basic					
Item	Sym- bol	Value	Unit	Item	Unit
Heat output			Type of heat input, for electric storage local space heaters only (select one)		
Nominal heat output	P_{nom}		kW	manual heat charge control, with integrated thermostat	[yes/no]
Minimum heat output (indicative)	P_{min}		kW	manual heat charge control with room and/or outdoor temperature feedback	[yes/no]

Maximum continuous heat output	$P_{max,c}$		kW	electronic heat charge control with room and/or outdoor temperature feedback	[yes/no]
Auxiliary electricity consumption				fan assisted heat output	[yes/no]
At nominal heat output	el_{max}	<0,00062	kW	Type of heat output/ room temperature control (select one)	
At minimum heat output	el_{min}	<0,00062	kW	single stage heat output and no room temperature control	[no]
In standby mode	el_{SB}	<0,000175	kW	Two or more manual stages, no room temperature control	[no]
				with mechanic thermostat room temperature control	[no]

				with electronic room temperature control	[no]
				electronic room temperature control plus day timer	[no]
				electronic room temperature control plus week timer	[yes]
				Other control options (multiple selections possible)	
				room temperature control, with presence detection	[no]
				room temperature control, with open window detection	[no]

				with distance control option	[no]
				with adaptive start control	[yes]
				with working time limitation	[no]
				with black bulb sensor	[no]
Contact details				Danfoss A/S, Nordborgvej 81, 6430 Nordborg, Denmark	

7 Warranty



A 2-year product warranty is valid for:

- thermostats incl. DEVIreg™ Basic.

Should you, against all expectations, experience a problem with your DEVI product, you will find that Danfoss offers DEVIwarranty valid from the **date of purchase that was no later than 2 years from production date** on the following conditions:

During the warranty period Danfoss shall offer a new comparable product or repair the product if the product is found to be faulty by reason of defective design, materials or workmanship. The decision to either repair or replace will be solely at the discretion of Danfoss.

The decision to either repair or replace will be solely at the discretion of Danfoss. Danfoss shall not be liable for any consequential or incidental damages including, but not limited to, damages to property or extra utility expenses. No extension of the warranty period following repairs undertaken is granted.

The warranty shall be valid only if the WARRANTY CERTIFICATE is completed correctly and in accordance with the instructions, the fault is submitted to the installer or the seller without undue delay and proof of purchase is provided. Please note that the WARRANTY CERTIFICATE must be filled in, stamped and signed by the authorized installer performing the installation (Installation date must be indicated). After the installation is performed, store and keep the WARRANTY CERTIFICATE and purchase documents (invoice, receipt or similar) during the whole warranty period.

DEVWarranty shall not cover any damage caused by incorrect conditions of use, incorrect installation or if installation has been carried out by non-authorized electricians. All work will be invoiced in full if Danfoss is required to inspect or repair faults that have arisen as a result of any of the above. The DEVWarranty shall not extend to products which have not been paid in full. Danfoss will, at all times, provide a rapid and effective response to all complaints and inquiries from our customers.

The warranty explicitly excludes all claims exceeding the above conditions. For full warranty text visit **www.devi.com**.
devi.danfoss.com/en/warranty/

WARRANTY CERTIFICATE

The DEVI warranty is granted to:

Address

Stamp

Purchase date

Serial number of the
product

Product

Art. No.

*Connected output [W]

Installation Date
& Signature

Connection Date
& Signature

**Not mandatory*

8 Disposal instruction



This symbol on the product indicates that it may not be disposed of as household waste.

It must be handed over to the applicable take-back scheme for the recycling of electrical and electronic equipment.

- Dispose of the product through channels provided for this purpose.
- Comply with all local and currently applicable laws and regulations.

Danfoss A/S
Nordborgvej 81
6430 Nordborg
Denmark

Danfoss A/S

DEVI • devi.com • +45 7488 8500 • E-Mail: EH@danfoss.com

Danfoss can accept no responsibility for possible errors in catalogues, brochures and other printed material. Danfoss reserves the right to alter its products without notice. This also applies to products already on order provided that such alterations can be made without consequential changes being necessary in specifications already agreed. All trademarks in this material are property of the respective companies. DEVI and all DEVI logotypes are trademarks of Danfoss A/S. All rights reserved.

140F1160 DEVIreg™ Basic

DEVI 

by Danfoss

Designed in Denmark



140R0010

Floor thermostat

220-240V~

Load 16 A/3680 W @

230V ~

50/60Hz

0T35°C

IP21

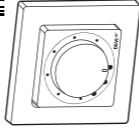

Danfoss Ltd. 22
Wycombe End
HP9 1NB, GB



MADE IN THAILAND



5 703466 250372