

# SK 95 GAB 06 UF



**SEMITOP® 3**

Single phase ultrafast bridge rectifier with single IGBT

## SK 95 GAB 06 UF

### Features

- 1200V trench4 IGBT
- CAL4F antiparallel diode
- Hyperfast rectifier diodes
- Compact design
- One screw mounting
- Heat transfer and insulation through direct copper bonded aluminum oxide ceramic (DBC)

### Typical Applications\*

- Switching (not for linear use)
- Resonant applications
- Switch mode power supply
- UPS

### Remarks

Hyperfast diode = Rectifier  
CAL4F diode = Diode2

Dynamic measurements set-up:

- IGBT switching on external 50A 1200V CAL4F diode
- Diode2 switching on external 15A 1200V Trench4 IGBT

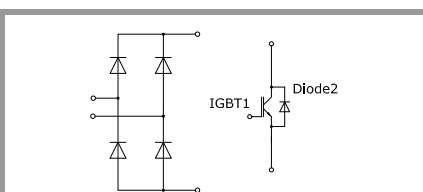

**GAB**

Absolute Maximum Ratings			
Symbol	Conditions	Values	Unit
<b>IGBT 1</b>			
$V_{CES}$	$T_j = 25\text{ °C}$	1200	V
$I_C$	$T_j = 150\text{ °C}$	$T_s = 25\text{ °C}$	56
		$T_s = 70\text{ °C}$	43
$I_C$	$T_j = 175\text{ °C}$	$T_s = 25\text{ °C}$	63
		$T_s = 70\text{ °C}$	51
$I_{Cnom}$		50	A
$I_{CRM}$	$I_{CRM} = 3 \times I_{Cnom}$	150	A
$V_{GES}$		-20 ... 20	V
$t_{psc}$	$V_{CC} = 800\text{ V}$ $V_{GE} \leq 15\text{ V}$ $V_{CES} \leq 1200\text{ V}$	$T_j = 150\text{ °C}$	10
$T_j$		-40 ... 175	°C

Absolute Maximum Ratings			
Symbol	Conditions	Values	Unit
<b>Rectifier</b>			
$V_{RSM}$	$T_j = 25\text{ °C}$	600	V
$V_{RRM}$	$T_j = 25\text{ °C}$	600	V
$I_D$	rec 120° $T_j = 150\text{ °C}$	$T_s = 25\text{ °C}$	126
		$T_s = 70\text{ °C}$	95
$I_{FSM}$	sin 180° 10 ms	$T_j = 25\text{ °C}$	630
		$T_j = 150\text{ °C}$	549
$i^2t$	sin 180° 10 ms	$T_j = 25\text{ °C}$	1984
		$T_j = 150\text{ °C}$	1507
$T_j$		-40 ... 150	°C

Absolute Maximum Ratings			
Symbol	Conditions	Values	Unit
<b>Diode 2</b>			
$V_{RRM}$	$T_j = 25\text{ °C}$	1200	V
$I_F$	$T_j = 150\text{ °C}$	$T_s = 25\text{ °C}$	18
		$T_s = 70\text{ °C}$	14
$I_F$	$T_j = 175\text{ °C}$	$T_s = 25\text{ °C}$	21
		$T_s = 70\text{ °C}$	17
$I_{Fnom}$		15	A
$I_{FRM}$	$I_{FRM} = 2 \times I_{Fnom}$	30	A
$I_{FSM}$	10 ms, sin 180°, $T_j = 150\text{ °C}$	65	A
$T_j$		-40 ... 175	°C

Absolute Maximum Ratings			
Symbol	Conditions	Values	Unit
<b>Module</b>			
$I_{t(RMS)}$		-	A
$T_{stg}$		-40 ... 125	°C
$V_{isol}$	AC, sinusoidal, t = 1 min	2500	V

# SK 95 GAB 06 UF



**SEMITOP® 3**

## Single phase ultrafast bridge rectifier with single IGBT

### SK 95 GAB 06 UF

#### Features

- 1200V trench4 IGBT
- CAL4F antiparallel diode
- Hyperfast rectifier diodes
- Compact design
- One screw mounting
- Heat transfer and insulation through direct copper bonded aluminum oxide ceramic (DBC)

#### Typical Applications\*

- Switching (not for linear use)
- Resonant applications
- Switch mode power supply
- UPS

#### Remarks

Hyperfast diode = Rectifier  
CAL4F diode = Diode2

Dynamic measurements set-up:

- IGBT switching on external 50A 1200V CAL4F diode
- Diode2 switching on external 15A 1200V Trench4 IGBT

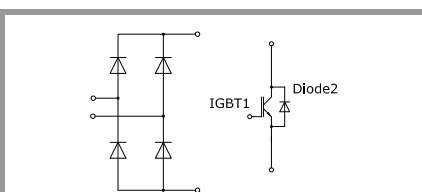

**GAB**

Characteristics						
Symbol	Conditions		min.	typ.	max.	Unit
<b>IGBT 1</b>						
$V_{CE(sat)}$	$I_C = 50\text{ A}$ $V_{GE} = 15\text{ V}$ chipllevel	$T_j = 25\text{ °C}$	1.85	2.10		V
		$T_j = 150\text{ °C}$	2.20	2.40		V
$V_{CE0}$	chipllevel	$T_j = 25\text{ °C}$	0.80	0.90		V
		$T_j = 150\text{ °C}$	0.70	0.80		V
$r_{CE}$	$V_{GE} = 15\text{ V}$ chipllevel	$T_j = 25\text{ °C}$	21	24		mΩ
		$T_j = 150\text{ °C}$	30	32		mΩ
$V_{GE(th)}$	$V_{GE} = V_{CE}, I_C = 1.7\text{ mA}$		5	5.8	6.5	V
$I_{CES}$	$V_{GE} = 0\text{ V}$ $V_{CE} = 1200\text{ V}$	$T_j = 25\text{ °C}$	-	1		mA
			-			mA
$C_{ies}$	$V_{CE} = 25\text{ V}$ $V_{GE} = 0\text{ V}$	$f = 1\text{ MHz}$	2.77			nF
$C_{oes}$		$f = 1\text{ MHz}$	0.205			nF
$C_{res}$		$f = 1\text{ MHz}$	0.16			nF
$Q_G$	$V_{GE} = -7V...+15V$			375		nC
$R_{Gint}$	$T_j = 25\text{ °C}$			4.0		Ω
$t_{d(on)}$	$V_{CC} = 600\text{ V}$	$T_j = 150\text{ °C}$		63		ns
$t_r$	$I_C = 50\text{ A}$	$T_j = 150\text{ °C}$		65		ns
$E_{on}$	$V_{GE\ neg} = -7\text{ V}$ $V_{GE\ pos} = 15\text{ V}$	$T_j = 150\text{ °C}$		8.3		mJ
$t_{d(off)}$	$R_{G\ on} = 32\text{ Ω}$	$T_j = 150\text{ °C}$		521		ns
$t_f$	$R_{G\ off} = 32\text{ Ω}$	$T_j = 150\text{ °C}$		80		ns
$E_{off}$	$di/dt_{on} = 920\text{ A/μs}$ $di/dt_{off} = 920\text{ A/μs}$	$T_j = 150\text{ °C}$		5		mJ
$R_{th(j-s)}$	per IGBT			0.83		K/W

Characteristics						
Symbol	Conditions		min.	typ.	max.	Unit
<b>Rectifier</b>						
$V_F$	$I_F = 75\text{ A}$ $V_{GE} = 0\text{ V}$ chipllevel	$T_j = 25\text{ °C}$	1.80	2.20		V
		$T_j = 125\text{ °C}$	1.60	2.00		V
$V_{F0}$	chipllevel	$T_j = 25\text{ °C}$	1.15	1.35		V
		$T_j = 125\text{ °C}$	0.85	1.05		V
$r_F$	chipllevel	$T_j = 25\text{ °C}$	8.7	11		mΩ
		$T_j = 125\text{ °C}$	10	13		mΩ
$I_R$	$T_j = 25\text{ °C}, V_{RRM}$			0.1		mA
$R_{th(j-s)}$	per Diode			1.16		K/W

# SK 95 GAB 06 UF



**SEMITOP® 3**

Single phase ultrafast bridge rectifier with single IGBT

## SK 95 GAB 06 UF

### Features

- 1200V trench4 IGBT
- CAL4F antiparallel diode
- Hyperfast rectifier diodes
- Compact design
- One screw mounting
- Heat transfer and insulation through direct copper bonded aluminum oxide ceramic (DBC)

### Typical Applications\*

- Switching (not for linear use)
- Resonant applications
- Switch mode power supply
- UPS

### Remarks

Hyperfast diode = Rectifier  
CAL4F diode = Diode2

Dynamic measurements set-up:

- IGBT switching on external 50A 1200V CAL4F diode
- Diode2 switching on external 15A 1200V Trench4 IGBT

Characteristics						
Symbol	Conditions		min.	typ.	max.	Unit
<b>Diode 2</b>						
$V_F$	$I_F = 15\text{ A}$	$T_j = 25\text{ °C}$		2.38	2.71	V
	chipelevel	$T_j = 150\text{ °C}$		2.44	2.77	V
$V_{F0}$	chipelevel	$T_j = 25\text{ °C}$		1.30	1.50	V
		$T_j = 150\text{ °C}$		0.90	1.10	V
$r_F$	chipelevel	$T_j = 25\text{ °C}$		72	81	mΩ
		$T_j = 150\text{ °C}$		103	111	mΩ
$I_{RRM}$	$I_F = 15\text{ A}$	$T_j = 150\text{ °C}$		28		A
$Q_{rr}$	$di/dt_{off} = 2750\text{ A/}\mu\text{s}$	$T_j = 150\text{ °C}$		0.3		μC
$E_{rr}$	$V_{GE} = 15\text{ V}$ $V_{CC} = 600\text{ V}$	$T_j = 150\text{ °C}$		0.82		mJ
$R_{th(j-s)}$	per Diode			2.3		K/W

Characteristics						
Symbol	Conditions		min.	typ.	max.	Unit
<b>Module</b>						
$M_s$	to heatsink		2.25		2.5	Nm
w	weight			29		g

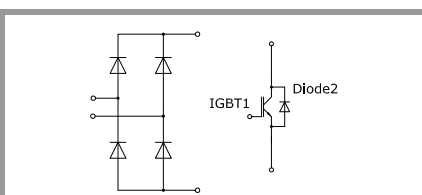

**GAB**

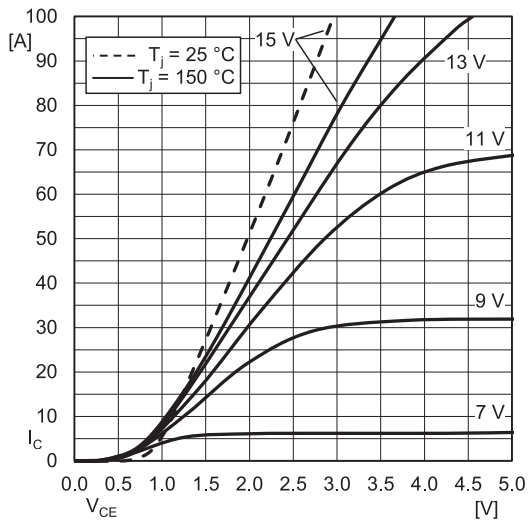

Fig. 1: Typ. output characteristic, inclusive  $R_{CC'+EE'}$

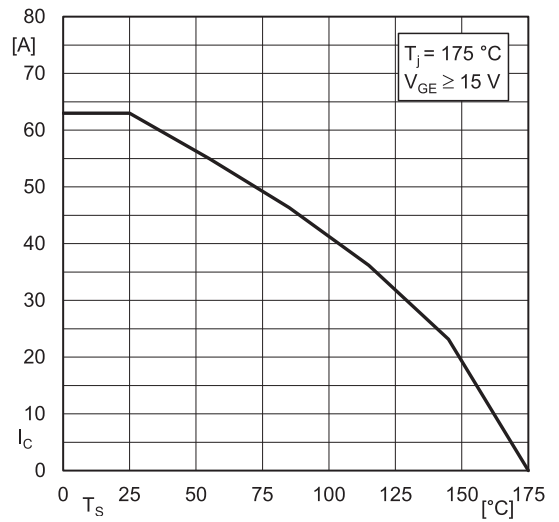

Fig. 2: Rated current vs. temperature  $I_C = f(T_C)$

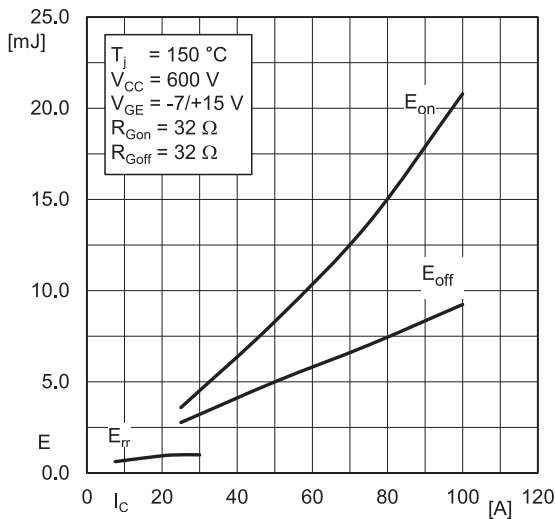

Fig. 3: Typ. turn-on /-off energy =  $f(I_C)$

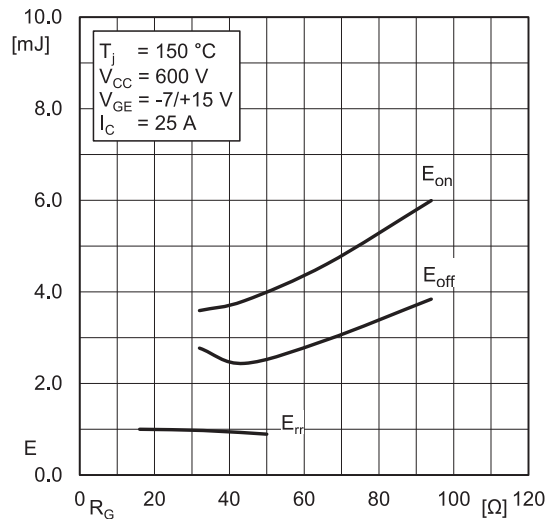

Fig. 4: Typ. turn-on /-off energy =  $f(R_G)$

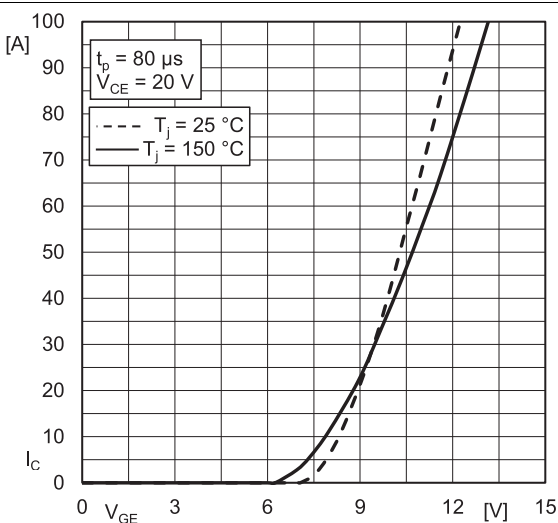

Fig. 5: Typ. transfer characteristic

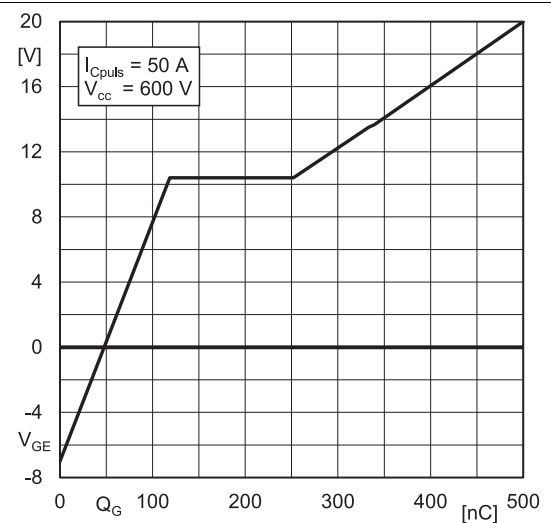

Fig. 6: Typ. gate charge characteristic

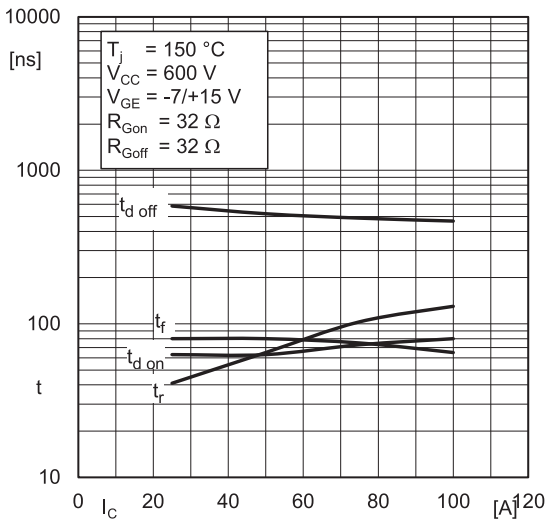

Fig. 7: Typ. switching times vs.  $I_C$

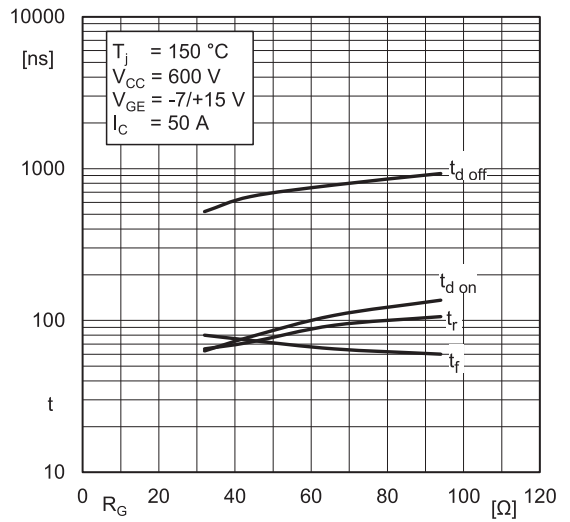

Fig. 8: Typ. switching times vs. gate resistor  $R_G$

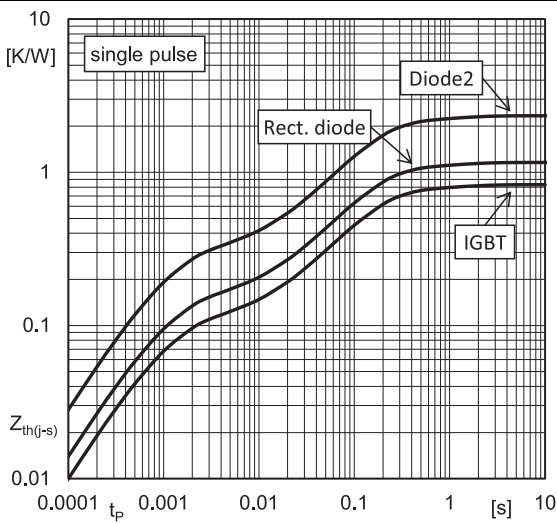

Fig. 9: Typ. transient thermal impedance

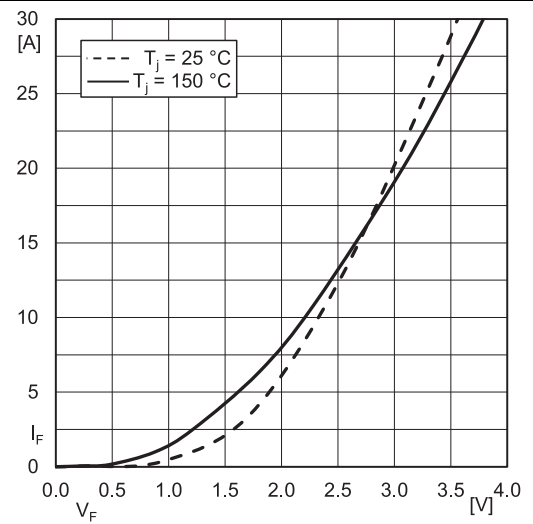

Fig. 10: Typ. CAL diode forward charact., incl.  $R_{CC'+EE'}$

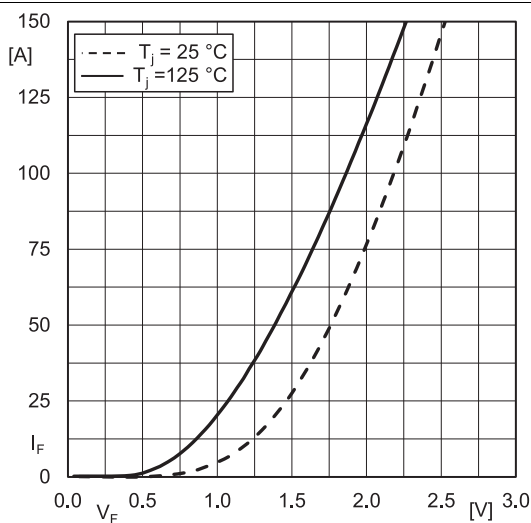
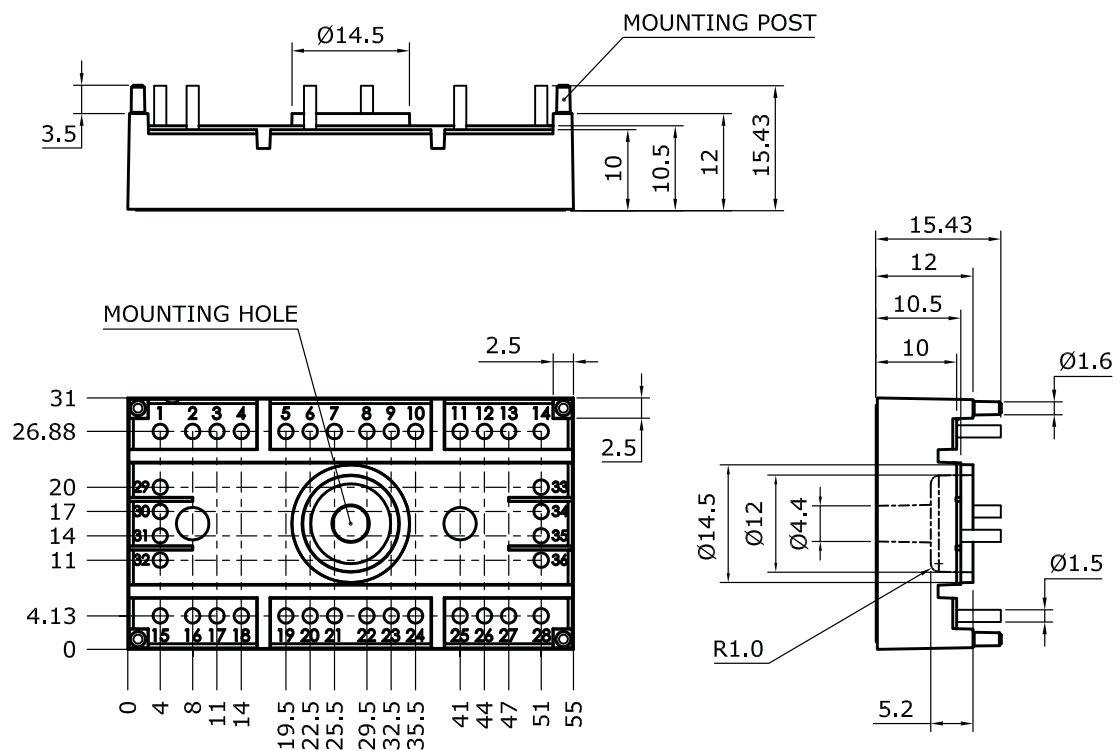

Fig. 11: Typ. Rect. diode forward charact., incl.  $R_{CC'+EE'}$

# SK 95 GAB 06 UF

Dimensions: mm

Tolerance system: ISO 2768-m



Suggested hole diameter for solder pins in the circuit board:

- 2.0 mm

Suggested hole diameter for the mounting post in the circuit board:

- 2.0 mm

These documents are SEMIKRON properties. SEMIKRON reserves all copyrights. All copying and transmitting of this information requires written permission. For the case of industrial property rights, SEMIKRON reserves all rights.

SEMITOP®3

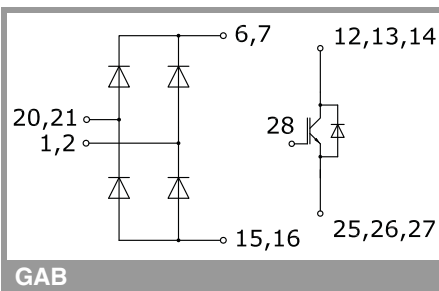

GAB

This is an electrostatic discharge sensitive device (ESDS), international standard IEC 60747-1, chapter IX.

## **\*IMPORTANT INFORMATION AND WARNINGS**

The specifications of SEMIKRON products may not be considered as guarantee or assurance of product characteristics ("Beschaffenheitsgarantie"). The specifications of SEMIKRON products describe only the usual characteristics of products to be expected in typical applications, which may still vary depending on the specific application. Therefore, products must be tested for the respective application in advance. Application adjustments may be necessary. The user of SEMIKRON products is responsible for the safety of their applications embedding SEMIKRON products and must take adequate safety measures to prevent the applications from causing a physical injury, fire or other problem if any of SEMIKRON products become faulty. The user is responsible to make sure that the application design is compliant with all applicable laws, regulations, norms and standards. Except as otherwise explicitly approved by SEMIKRON in a written document signed by authorized representatives of SEMIKRON, SEMIKRON products may not be used in any applications where a failure of the product or any consequences of the use thereof can reasonably be expected to result in personal injury. No representation or warranty is given and no liability is assumed with respect to the accuracy, completeness and/or use of any information herein, including without limitation, warranties of non-infringement of intellectual property rights of any third party. SEMIKRON does not assume any liability arising out of the applications or use of any product; neither does it convey any license under its patent rights, copyrights, trade secrets or other intellectual property rights, nor the rights of others. SEMIKRON makes no representation or warranty of non-infringement or alleged non-infringement of intellectual property rights of any third party which may arise from applications. Due to technical requirements our products may contain dangerous substances. For information on the types in question please contact the nearest SEMIKRON sales office. This document supersedes and replaces all information previously supplied and may be superseded by updates. SEMIKRON reserves the right to make changes.