

ENGINEERING
TOMORROW

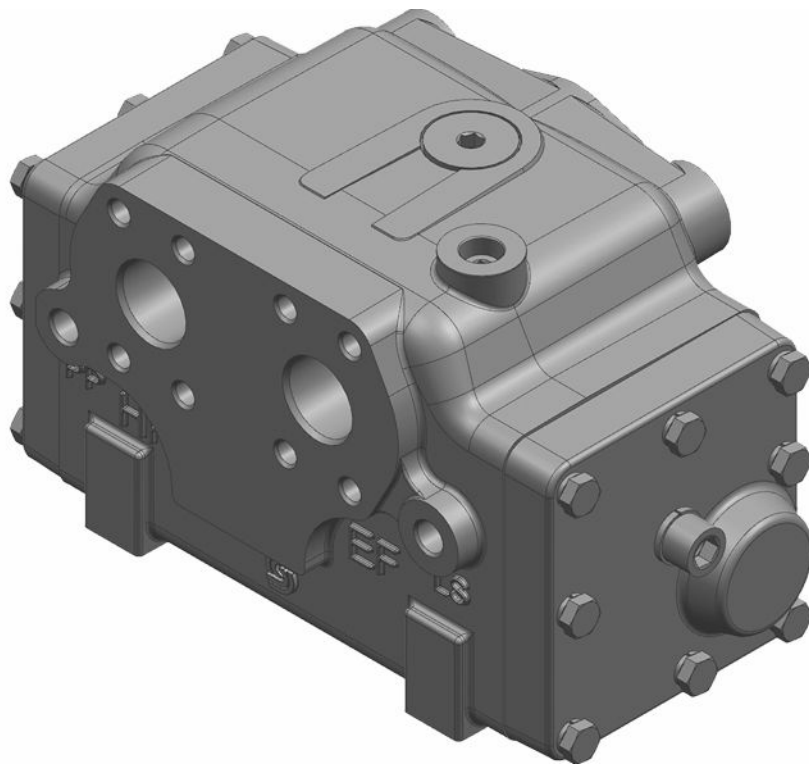

Service Manual

Flow amplifier OSQA/OSQB



Revision history

Table of revisions

Date	Changed	Rev
July 2016	First edition	0101

Contents

Introduction

Safety precautions.....	4
Symbols used in this literature.....	4
OSQ versions.....	5

Technical specifications

Exploded view.....	6
Parts list.....	6
OSQA and OSQB parts list.....	6
OSQ spare parts list.....	8
Tools.....	8

Disassembly

Dismantling counter pressure valve.....	9
Removing pressure relief valve	11
Removing end cover at PP-connection.....	12
Removing end cover at LS-connection.....	13
Unscrew orifices, throttle check valve.....	16
Housing and end cover with accessories.....	16
Spools with accessories.....	17
Dismantling directional spool.....	17
Priority valve spool number of orifices.....	17
Dismantling priority valve spool.....	18
Dismantling amplifier spool.....	19
Shock and suction valves.....	23
Cleaning.....	24
Inspection and replacement.....	24
Lubrication.....	24

Assembly

Assembling shock, suction, and check valve.....	25
Assembling amplifier spool.....	26
Assembling priority valve spool.....	28
Assembling directional spool.....	29
Installing orifice and throttle check valve.....	29
Installing shock valves.....	30
Assembling pressure relief valve.....	31
Installing OSQB back pressure valve.....	32
Installing spools.....	33
Installing PP end cover.....	34
Installing LS end cover.....	37
Plastic plugs.....	39

Testing

Set-up for testing.....	40
Steering test using steering unit type OSPBX LS.....	40
Pilot relief valve.....	41
Neutral positioning.....	41
Manual steering test.....	41

Introduction

Safety precautions

Always consider safety precautions before beginning a service procedure. Protect yourself and others from injury. Take the following general precautions whenever servicing a hydraulic system.

Warning

Unintended Machine Movement

Unintended movement of the machine or mechanism may cause injury to the technician or bystanders. To prevent unintended movement, secure the machine or disable / disconnect the mechanism while servicing.

Warning

Flammable Cleaning Solvents

Some cleaning solvents are flammable. To eliminate the risk of fire, do not use cleaning solvents in an area where a source of ignition may be present.

Warning

Fluid under Pressure

Escaping hydraulic fluid under pressure can have sufficient force to penetrate your skin causing serious injury and/or infection. This fluid may also be hot enough to cause burns. Use caution when dealing with hydraulic fluid under pressure. Relieve pressure in the system before removing hoses, fittings, gauges, or components. Never use your hand or any other body part to check for leaks in a pressurized line. Seek medical attention immediately if you are cut by hydraulic fluid.

Warning

Personal Safety

Protect yourself from injury. Use proper safety equipment, including safety glasses, at all times.











Warning

Product Safety

Steering valves are safety components and therefore it is extremely important that the greatest care is taken when servicing these products. There is not much wear on a steering valve and therefore they normally outlast the application they are built into. Therefore the only recommended service work on steering valves is:

- Changing seals and o-rings
- Disassemble, clean, and assemble if contaminated
- Hydraulic testing, including valve setting

Symbols used in this literature

	Non removable part, use a new part		Note correct orientation
	External hex head		Mark orientation for reinstallation
	Internal hex head		Torque specification
	Lubricate with hydraulic fluid		Press in - press fit
	Inspect for wear or damage		Pull out with tool - press fit

Introduction

OSQ versions

This service literature is valid for:

- OSQA: Flow-Amplifier without back pressure valve in HT
- OSQB: Flow-Amplifier with back pressure valve in HT

Technical specifications

Exploded view

OSQA and OSQB exploded view

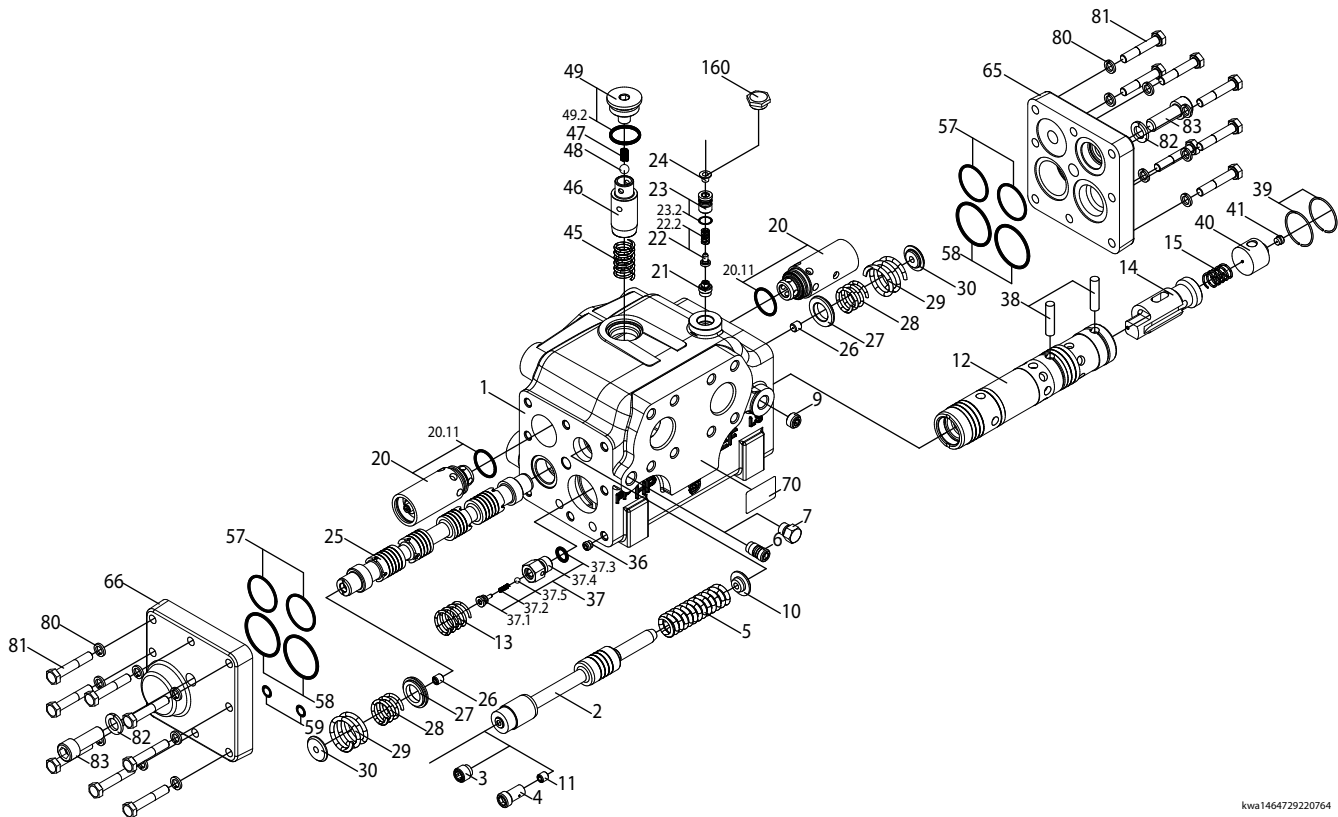

kwa1464729220764

Parts list

OSQA and OSQB parts list

Parts list

Part	Number per unit	Item	Tightening torque
Housing	1	1	—
Priority valve spool	1	2	—
Plug	1	3	10 ± 3 N·m
Throttle/check valve	1	4	10 ± 3 N·m
Compress spring	1	5	—
Throttle/check valve	1	6	10 ± 3 N·m
Plug	1	7	BSP: 40 ± 5 N·m UNF: 15 ± 3 N·m
Orifice, LS	1	9	10 ± 3 N·m
Spring stop	1	10	—
Orifice, dynamic	1	11	5 ± 1 N·m
Outer spool amplifier	1	12	—
Compress spring	1	13	—

Technical specifications

Parts list (continued)

Part	Number per unit	Item	Tightening torque
Inner spool, amplifier	1	14	—
Compress spring	1	15	—
Shock valve	2	20	—
O-ring Ø24 x 2 mm	2	20.11	—
Valve seat	1	21	20 ± 3 N·m
Pilot cone	1	22	—
Spring	1	22.2	—
Adjusting screw	1	23	—
O-ring Ø9 x 2 mm	1	23.2	—
Plug	1	24	—
Directional spool	1	25	—
Orifice	2	26	5 ± 1 N·m
Spring stop	2	27	—
Compress spring	2	28	—
Compress spring	2	29	—
Spring stop	2	30	—
Orifice	1	36	5 ± 1 N·m
Check valve	1	37	20 ± 3 N·m
Screw	1	37.1	5 ± 1 N·m
Compress spring	1	37.2	—
O-ring Ø10.3 x 2.4 mm	1	37.3	—
Valve seat	1	37.4	—
Ball	1	37.5	—
Pin	2	38	—
Locking ring	2	39	—
Plug	1	40	—
Orifice	1	41	5 ± 1 N·m
Compress spring, OSQB only	1	45	—
Piston, OSQB only	1	46	—
Compress spring, OSQB only	1	47	—
Ball, OSQB only	1	48	—
Plug, OSQB only	1	49	25 ± 3 N·m
O-ring Ø23.3 x 2.4 mm, OSQB only	1	49.2	—
O-ring Ø35 x 2 mm	4	57	—
O-ring Ø40 x 2 mm	4	58	—
O-ring Ø10 x 2 mm	2	59	—
Cover	1	65	—
Cover	1	66	—
Model/code label	1	70	—
Spring washer	16	80	—
Screw	16	81	25 ± 5/-0 N·m
Spring washer	2	82	—
Screw	2	83	80 ± 10 N·m
Plug with O-ring	1	160	25 ± 5 N·m

Technical specifications

OSQ spare parts list

Spare parts list

Spare parts	Code number	Item
Seal kit NBR for OSQ	150F0278	20.11, 23.2, 37.3, 49.2, 57, 58, 59, and two aluminum washers for pilot relief valve of OSQ from before week 43, year 2004
Seal kit Viton for OSQ	11020933	57, 58, 59
Pilot relief valve kit	11011038	21, 22, 22.2, 23, 23.2
Shock and suction valves complete, 140-160 bar	150F0281	20, 20.11
Shock and suction valves complete, 165-185 bar	150F0282	20, 20.11
Shock and suction valves complete, 200-220 bar	150F0286	20, 20.11
Shock and suction valves complete, 215-235 bar	150F0283	20, 20.11
Shock and suction valves complete, 230-250 bar	150F0284	20, 20.11
Shock and suction valves complete, 270-290 bar	150F0285	20, 20.11

Tools

Tools needed for assembly / disassembly



- Hexagon keys 4, 5, 6, 8, and 10 mm
- Ratchet for socket spanners
- Hexagon socket for external hexagon 6, 13, 17, and 19 mm
- Hexagon socket for internal hexagon 8 and 10 mm
- Multigrip pliers
- Ring spanner 13 mm
- Screwdrivers 3 and 10 mm
- Steel mandrels 3, 5 and 8 mm
- Torque wrench for 12 daNm [1060 lbf in]
- Magnetic rod
- Hook

These tools are not available from Danfoss.

Disassembly

OSQB: OSQ with back pressure valve in HT

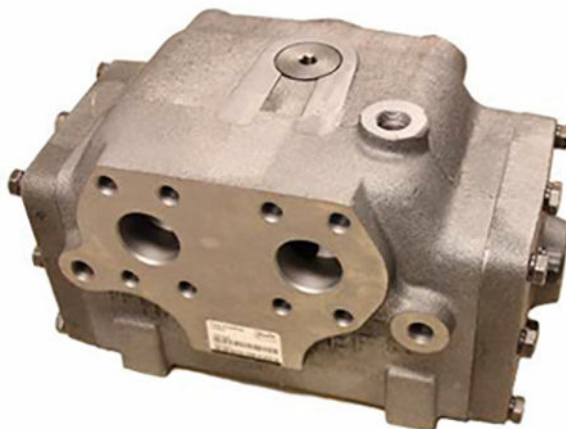

Place the unit on a work bench.

Dismantling counter pressure valve

1. Screw out the plug with O-ring (49) using an 8 mm  Hex key.



2. Take out the small spring (47) using a hook.



Disassembly

3. Take out ball (48) using a magnetic rod.



4. Take out the piston (46) using a hook.



5. Take out the spring (45) using a hook.



Dismantled counter pressure valve



Disassembly

Removing pressure relief valve

1. Remove plug (24) using a 2 mm screw driver.
Some special versions of OSQ have a cover plug (160) assembled on the top of the pilot relief valve. In such cases, use a 24 mm  socket spanner.

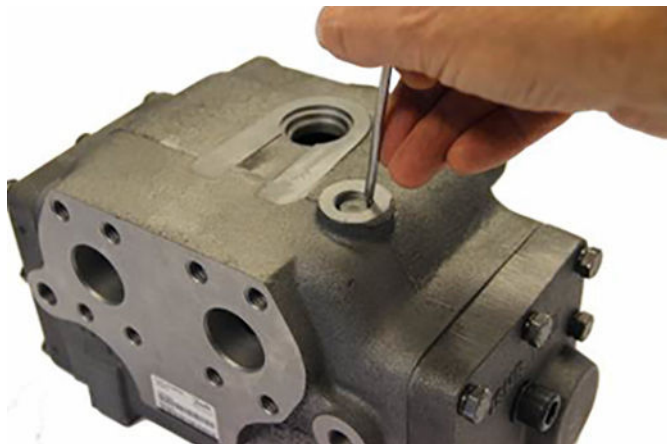

2. Screw out the adjusting screw (23) using a 6 mm  Hex key.
O-ring (23.2) is fitted to the screw (23).

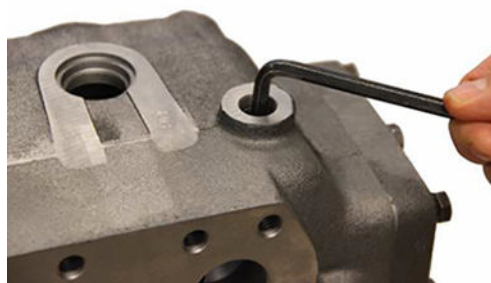

3. Remove the spring (22.2) with cone (22) using a hook or magnet rod.



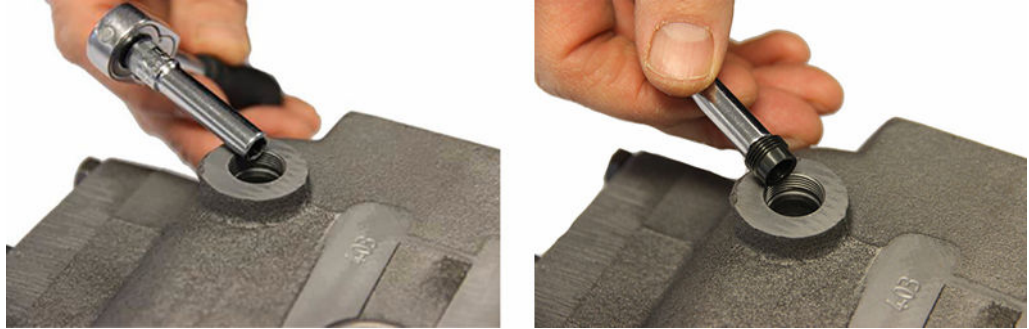

Disassembly

4. Screw out the seat (21) using a 6 mm  socket spanner.



Removing end cover at PP-connection

1. Unscrew screws (8x81) with spring washer (8x80) using a 13 mm  socket spanner and screw (83) with spring washer (82) using a 10 mm  Hex key.



2. Remove end cover (66).
Spring stop (30) and springs (28, 29 and 13) will follow the end cover.





Disassembly

3. Remove stop (27) from directional spool (25).



Removing end cover at LS-connection

1. Unscrew screws (8x81) with spring washer (8x80) using a 13 mm  socket spanner and screw (83) with spring washer (83) using a 10 mm  Hex key.



2. Remove end cover (65).
Spring stops (10 and 30) and springs (28 and 29) will follow the end cover.

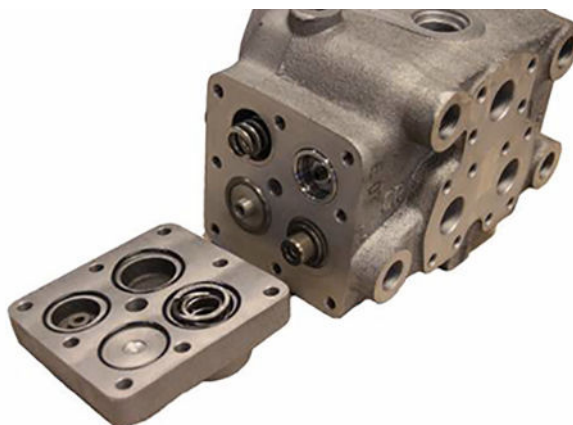

Disassembly

3. Remove spring stop (27) for directional spool (25).

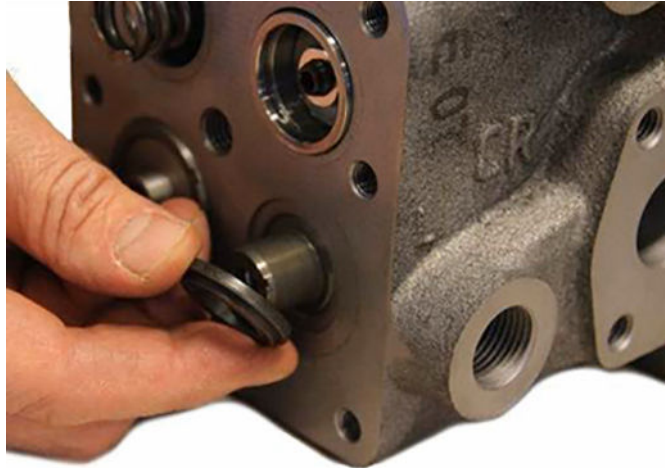

4. Remove spring (5) for priority spool (2).



5. Remove directional spool (25).

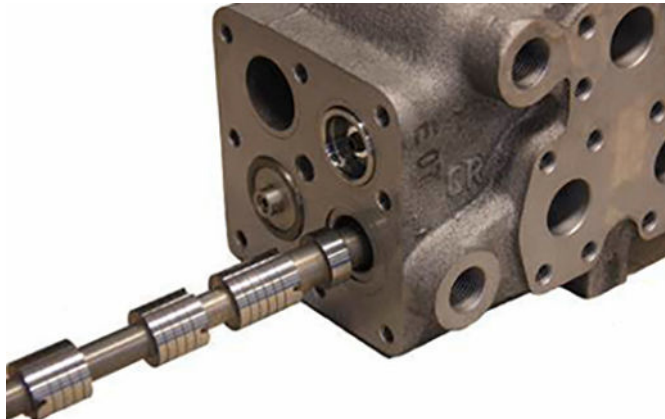

Disassembly

6. Remove amplifier spool (12).



7. Remove priority valve spool (2).



8. Remove shock valves (2x20) with screwdriver and hexagon key or mandrel.

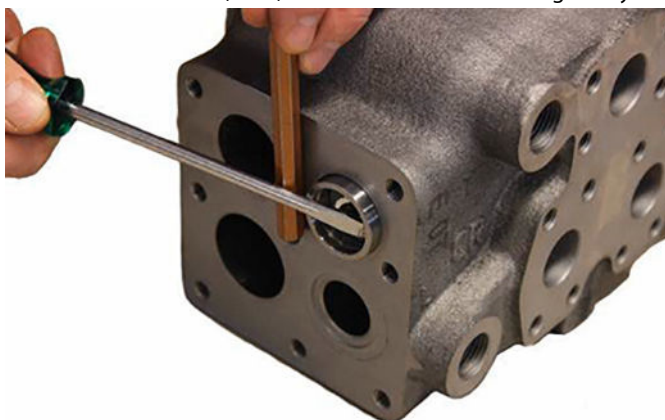

Disassembly

Unscrew orifices, throttle check valve

1. Unscrew orifice (9) in LS-connection using a 6 mm  Hex key.



2. Unscrew throttle check valve (6) (if present) in PP-connection using a 6 mm  Hex key.



3. Unscrew orifice (36) in housing using a 4 mm  Hex key.

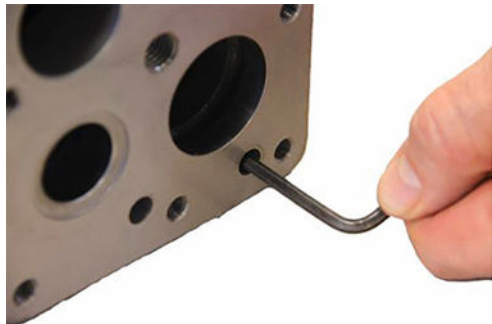

Housing and end cover with accessories

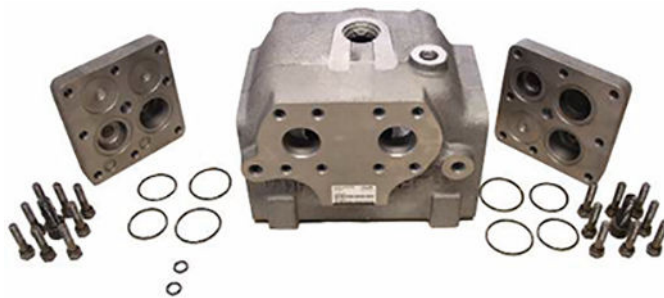

Disassembly

Spools with accessories



Dismantling directional spool

Use a mandrel for holding the spool, unscrew orifice (26) using a 4 mm  Hex key.



Dismantled directional spool (25) and orifice (26)



Priority valve spool number of orifices

Depending on versions this spool has none, 1, or 2 orifices:

- OSQ static with external PP: the priority valve spool has no orifice
- OSQ static with internal PP: the priority valve spool has throttle/check valve (4)
- OSQ dynamic with external PP: the priority valve spool has plug (3) and orifice, dynamic (11)
- OSQ dynamic with internal PP: the priority valve spool has throttle/check valve (4) and orifice, dynamic (11)
 - As shown in [Dismantling priority valve spool](#) on page 18

Disassembly

Dismantling priority valve spool

1. Unscrew throttle/check valve (4) using a 8 mm  Hex key and multigrip pliers.



2. Unscrew orifice, dynamic (11) using a 4 mm  Hex key and multigrip pliers.



Dismantled priority valve spool (25) with throttle/check valve (4) and orifice, dynamic (11)



Disassembly

Dismantling amplifier spool

1. Be careful not to damage the locking ring.

Carefully remove, from the amplifier spool (12), the locking ring (39) from the recess using a 3 mm screwdriver.



a) Carefully guide the locking ring (39) back.



2. Be careful not to damage the locking ring.

Carefully take the other locking ring (39) from the recess and guide it back using a 3 mm screwdriver.



Disassembly

a) Press out pin (38) using a 3 mm screwdriver or mandrel.



b) Take out the plug (40).



c) Take out the spring (15).



Disassembly

d) Take out the other pin (38) using a 3 mm screwdriver or mandrel.



e) Take out the inner spool (14).



3. Be careful not to damage the spool surface.

Disassembly

Unscrew check valve (37) using a 13 mm  socket spanner and a mandrel in the pin hole.



4. Unscrew orifice (41) from plug (40) using a 4 mm  Hex key and a mandrel in the pin hole.

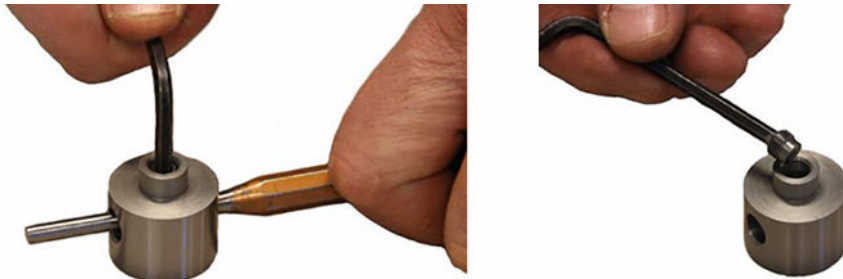

Disassembly

5. Unscrew plug (37.1) from check valve using a 4 mm Hex key, and a 17 mm socket spanner.
 - a) Remove spring (37.2) and ball (37.5) from valve seat (37.4).



Dismantled amplifier spool



Shock and suction valves

Shock valves are assembled into the OSQ, and cannot be adjusted. Preadjusted shock valves can be bought as spare parts, see [OSQ spare parts list](#) on page 8. Replace shock and suction valves if polluted. Replacing O-rings is recommended.

Shock and suction valve assembly (left) with O-ring dismantled (right)



Disassembly

Cleaning

Using low aromatic kerosene, clean all parts carefully.

Inspection and replacement

- Replace all seals and washers.
- Check all parts carefully and make any replacements as is necessary.

Lubrication

Before assembling, lubricate all parts with hydraulic oil.

Assembly

Assembling shock, suction, and check valve

1. Place O-ring (20.11) on shock and suction valve cartridge (20).



2. Place O-ring (37.3) on valve seat/housing (37.4).



- a) Place housing in a 17 mm socket spanner.
- b) Place ball (37.5), spring (37.2) and plug (37.1) in housing (37.4) and tighten, using a 4 mm Hex key and a 17 mm socket spanner, $5 \pm 1 \text{ N}\cdot\text{m}$ [$45 \pm 10 \text{ lbf}\cdot\text{in}$].



3. Place orifice (41) in plug (40) and tighten in the pin hole, using a 4 mm Hex key and a mandrel, $5 \pm 1 \text{ N}\cdot\text{m}$ [$45 \pm 10 \text{ lbf}\cdot\text{in}$].



Assembly

4. Place check valve (37) in spool (12) and tighten in the pin hole, using a 13 mm  socket spanner and a mandrel,  $20 \pm 3 \text{ N}\cdot\text{m}$ [$177 \pm 27 \text{ lbf}\cdot\text{in}$].



Assembling amplifier spool

Place inner spool in the correct position.

When assembling OSQA 5 and OSQB 5 there are two ways of placing the inner spool, only one is correct. The pilot channel which faces upwards must be lined up with one of the 5 amplification holes in the outer spool.

Inner spool in correct position

1. Guide inner spool (14) into outer spool (12).

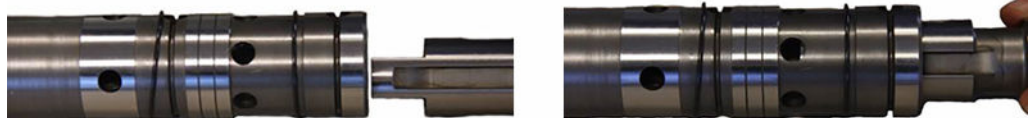

2. Place the pin (38) through outer (12) and inner (14) spool.



Assembly

a) Push locking ring (39) into position.



b) Place locking ring into the recess with end facing away from pin holes.

3. Place spring (15) on end of the inner spool (14).



a) Place plug (40).



b) Place pin (38) through outer spool (12) and plug (40).

Assembly



4. Push locking ring (39) into position.
 - a) Place locking ring into the recess with ends facing away from pin holes.



Assembling priority valve spool

The priority valve spool has throttle/check valve (4) and orifice, dynamic (11).

1. Screw in orifice, dynamic (11) using a 4 mm  Hex key and a  multigrip pliers, 5 ± 1 N·m.



Assembly

2. Screw in throttle/check valve (4) using a 8 mm Hex key and a multigrip pliers, 10 ± 0.3 Nm.



Assembling directional spool

- Screw in orifices, 2x (26) in directional spool (25) using a 4 mm Hex key and mandrel for holding the spool, 5 ± 1 N·m [45 ± 10 lbf·in].



Installing orifice and throttle check valve

1. Screw orifice (36) in housing using a 4 mm Hex key, 5 ± 1 N·m [45 ± 10 lbf·in].

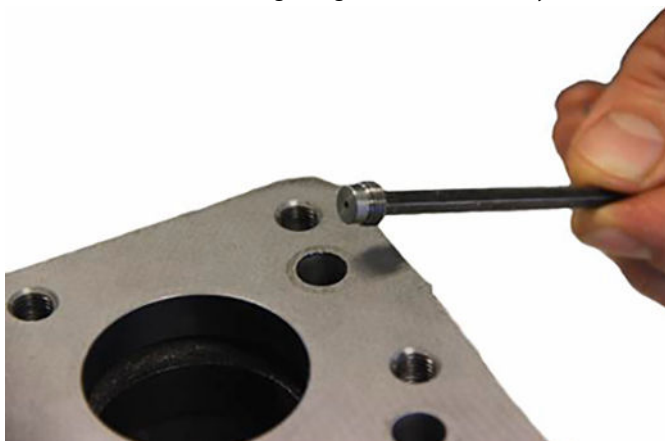

Assembly

2. Screw orifice (9) in LS-connection using a 6 mm Hex key, 10 ± 3 N·m [89 ± 27 lbf·in].



3. Screw throttle check valve (6), if present in PP-connection using an 8 mm Hex key, 10 ± 3 N·m [89 ± 27 lbf·in].



Flow amplifiers with internal PP, plugs for PP port:

- 1/4 BSP female in PP-connection; Fit washer and plug; Tightening torque: 40 ± 5 N·m [354 ± 44 lbf·in].
- 7/16 – 20 UNF in PP-connection; Fit O-ring and plug; Tightening torque: 15 ± 3 N·m [133 ± 27 lbf·in].

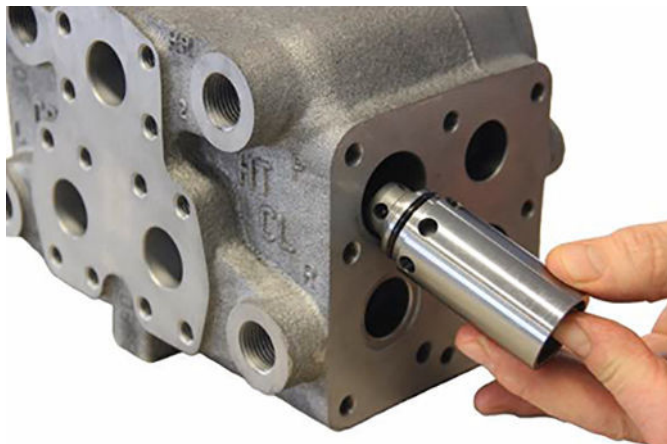

Installing shock valves

Guide shock valves, 2x (20) with O-rings (2x 20.11) in and then secure it by hand.



Assembly

Assembling pressure relief valve

1. Screw in the seat (21) using a 6 mm  socket spanner,  20 ± 3 N·m [177 ± 27 lbf·in].



2. Place in the spring with cone (22).

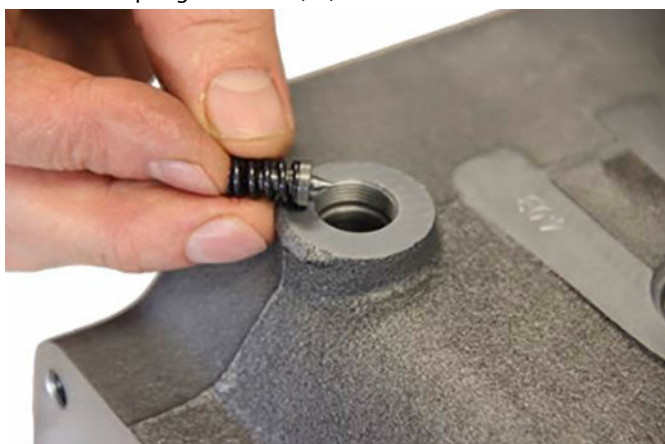

3. Place O-ring on adjusting screw (23), then screw in, using a 6 mm  Hex key.
After entire assembly of the steering valve, make the pressure setting on a test panel according to valve setting specification, see [Testing](#) on page 40.
 - a) Insert plastic protection plug (24).



Assembly

Installing OSQB back pressure valve

Fit spring (45) in position on piston (46) with Vaseline.

1. Place in assembled piston and spring.



2. Place in ball (48) in the piston (46).

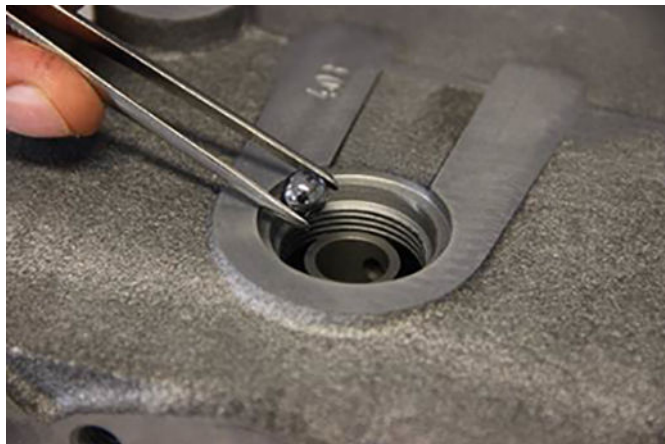

3. Place O-ring (49.2) on plug (49).
 - a) Fit spring (47) in plug (49) with Vaseline.



- b) Screw in assembled plug and spring using an 8 mm Hex key, 25 ± 3 N·m [221 ± 27 lbf·in].

Assembly



Installing spools

1. Spring control must be placed in correct position against LS-connection.

Guide priority valve spool (2) into place.

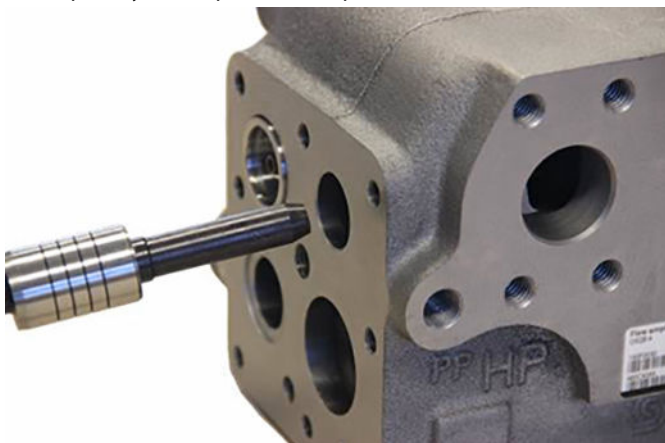

2. Place spring (5) on priority valve spool (2)

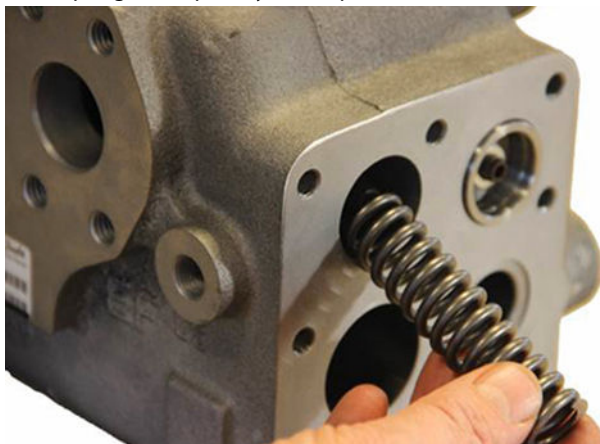

3. The orifice must be placed in correct position against LS-connection.

Assembly

Guide amplifier spool (12) into place.



4. Guide directional spool (25) into place.

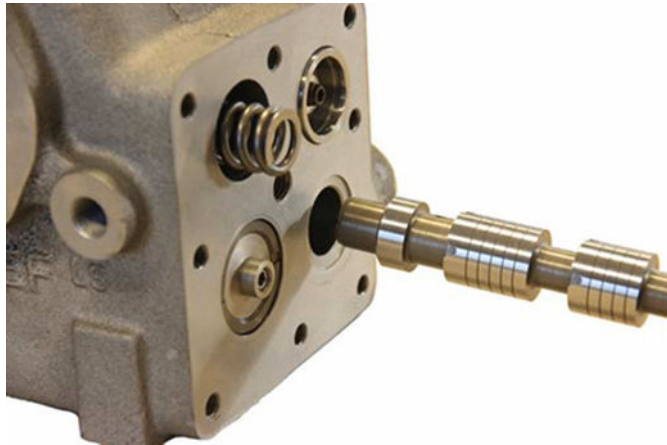

Installing PP end cover

1. Place spring stop (27) on the directional spool (25).

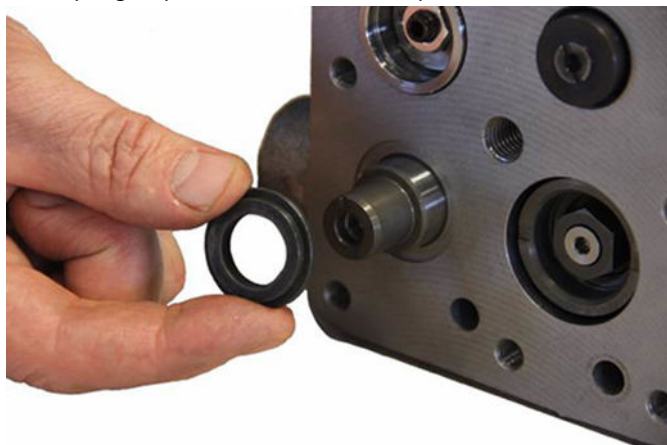

2. The spring must be fitted at the PP-connection.

Assembly

Place spring (13) with Vaseline in amplifier spool (12).

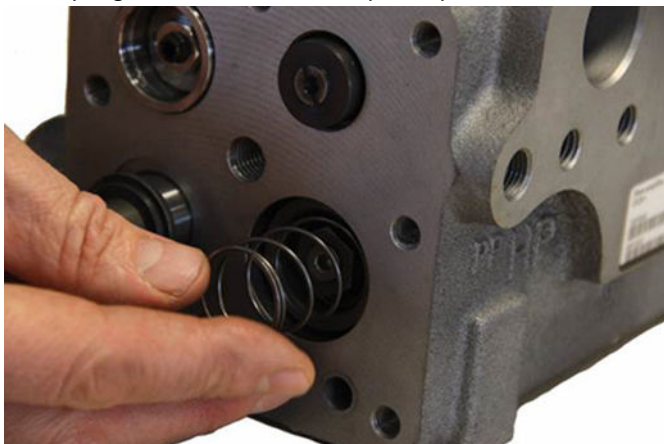

3. Place O-rings, 2x (57), 2x (58) and 2x (59) and spring stop (30) in end cover (66).



a) Place large spring (29) and small spring (28) in end cover (66).



Assembly

4. Place washers 8x (80) on screws 8x (81).
 - a) Place the 2 screws with washers in end cover (66), see [Exploded view](#) on page 6.

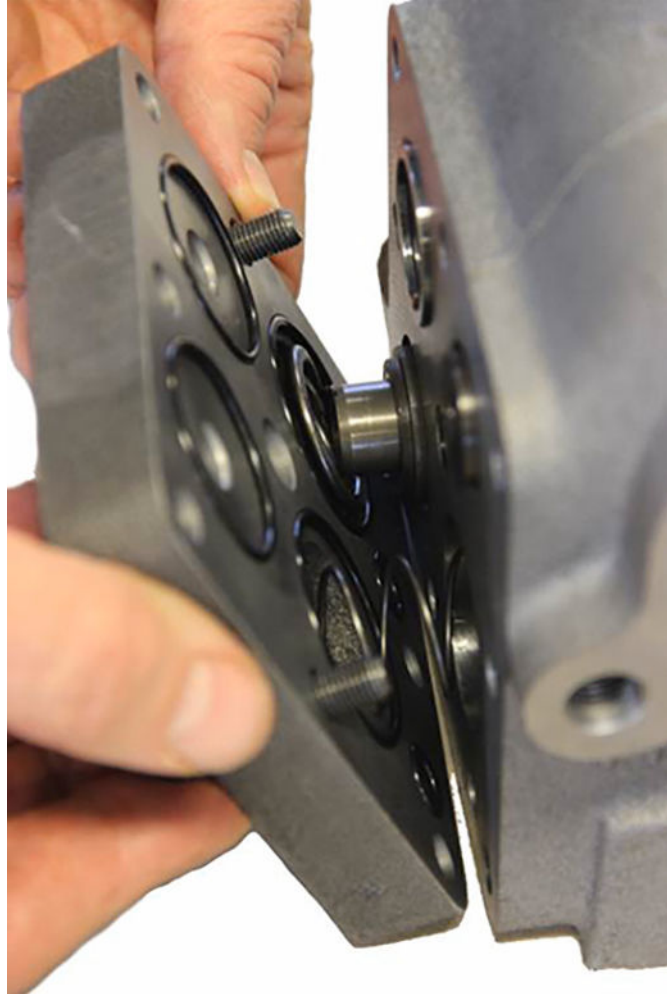



Make sure that all O-rings stay in place. The two screws must screw in with fingers only, so that the end cover stays in parallel with flange area of the housing only, with distance for compressing the O-rings less than 1 mm.

- b) Screw in screw (83) with washer (82) using a 10 mm  Hex key until end cover is in place.



Assembly

- c) Screw in remaining six screws (81) with washers (80) using a 13 mm  socket spanner,  25 ± 5 N·m [221 ± 44 in·lbf] or  80 ± 10 N·m [708 ± 89 in·lbf] for the 10 mm Hex key.



Installing LS end cover

1. Place spring stop (27) on the directional spool (25).



2. Place O-rings, 2x (57) and 2x (58) and spring stop (10) in end cover (65).



Assembly

3. Place spring stop (30) in end cover (65).



- a) Place large spring (29) and small spring (28) in end cover (65).



4. Place washers 2x (80) on screws 2x (81).

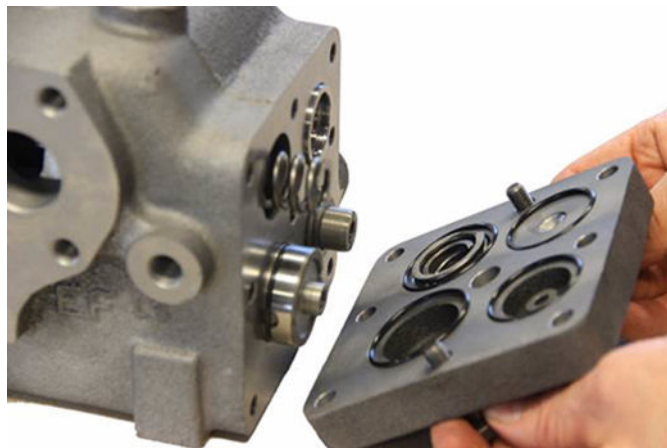

- a) Place the 2 screws with washers as illustrated in end cover (65), see [Exploded view](#) on page 6.

Make sure that all O-rings stay in place. It must be possible to screw in the 2 screws using a 13 mm socket spanner with very light torque, so that the end cover stays in parallel with flange area of the housing and only with distance for compressing the O-rings less than 1 mm.



- b) Screw in screw (83) with washer (82) using a 10 mm  Hex key until end cover is in place.

Assembly

- c) Screw in remaining six screws (81) with washers (80) using a 13 mm  socket spanner,  25 ± 5 N·m [221 ± 44 in·lbf] or  80 ± 10 N·m [708 ± 89 in·lbf] for the 10 mm Hex key.

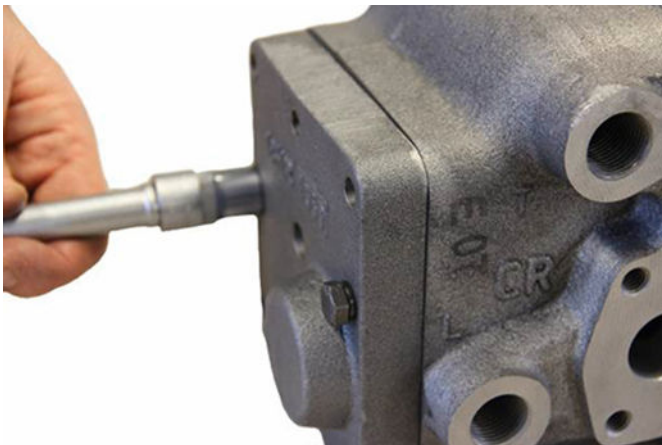

Plastic plugs

Place or screw in the plastic plugs after testing or if storage is needed between assembly and testing.

Plastic plugs placed or screwed into ports

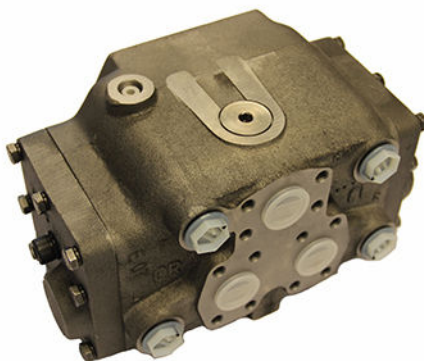

Testing

This section describes minimum tests needed, when the OSQ steering valve has been disassembled and reassembled.

OSQ system

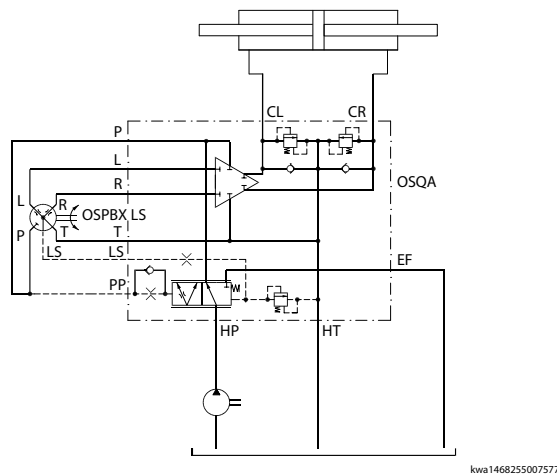

Set-up for testing

Use universal hydraulic work bench with pump capacity: 140 l/min and up to 240 bar pressure for relief valve setting and steering test.

If the recommended pump flow is not available, then take the characteristic of pilot relief valve into consideration. Reference *OSPB/C/F/D/L LS Steering Units, OLS Priority Valves, OSQ Flow Amplifiers Technical Information, BC0000009*, the HP/Qp characteristic in the OSQ chapter, under Technical data.

The hydraulic oil must be with a viscosity of 21 cSt. at 50° and with maximum degree of contamination according to ISO 4406: 21 / 19 / 16.

1. Connect double rod cylinder to CL and CR ports of OSQ.
2. Connect pilot steering unit OSPBX LS to OSQ: L to L, R to R, P to P, T to T, LS to LS.
3. Connect HT and EF port of OSQ to tank of pump station.
4. With LS pump in pump station: connect LS of OSQ-OSP to LS of pump.
5. Connect pressure gages to all ports of OSQ.
6. Connect steering column and steering wheel to the input shaft of the OSPBX steering unit.

T pressure should not exceed approximately 5 bar. Maximum allowed T pressure is 15 bar. Pump supply circuit must be adjusted not to exceed 240 bar P-T.

Steering test using steering unit type OSPBX LS

During the testing the following must not occur: motor effect, disturbing vibrations, noise, sticking or other irregularities.

1. Start the pump.

The pump flow should be approximately 40 l/min and pump pressure control should be approximately 70 bar.

2. Let the supplied oil flow through the OSQ for a few minutes.
 - a) At the same time, rotate the steering wheel a few times in both directions to bleed air from the unit and the system.
3. Operate the steering wheel by approximately 10 rpm in a smooth manner from end stroke to end stroke of the steering cylinder for at least 5 cycles.
 - a) Make sure pressure P-T, 70 bar can be achieved, when steering against end stroke.

If this is not possible, the adjusting screw of the pilot relief valve (see item 23, [Exploded view](#) on page 6) must be turned clockwise until P-T, 70 bar is achievable.

Testing

4. Verify the steering cylinder does not move, when steering wheel is untouched.

The number of turns on steering wheel must match the following calculation:

i approximately or equal to V/V_{vs} where V is stroke volume of steering cylinder, ccm V_{vs} equals OSQ steering system displacement, ccm/rev

V , stroke volume if cylinder in test rig: 4000 ccm

V_{vs} , steering system displacement with OSQ 5 and OSPBX 200 LS: 1000 ccm/rev

Greater than i , approximately or equal to 4000/1000, equal to 4 turns lock to lock

Pilot relief valve

The pump flow is adjusted to approximately 140 l/min and pressure to maximum 240 bar.

The steering wheel is actuated until the steering cylinder reaches one of its end strokes and the steering wheel is actuated in this cylinder position with steering torque 20 ± 5 Nm.

The pilot relief valve (item 23 of exploded view) is set according to specification: Maximum steering pressure (P-T), bar, for the code in question.

The setting pressure is the pressure on the HP-port minus the HT-port of OSQ.

Neutral positioning

After adjusting the pilot relief valve, the steering wheel must be able to go to neutral position by itself no later than approximately 1 second after the activation of the steering wheel has been stopped.

The steering unit and OSQ are properly in neutral position when the pressure drop (HP-HT of OSQ) is no higher than 30 bar at pump flow 140 l/min, and there must be no movement of the steering cylinder.

Manual steering test

Without pressure on HP and HT ports, the OSPBX and OSQ must be able to steer in a smooth manner to the right and to the left observed by the cylinder movement.

The number of turns on the steering wheel for moving the steering cylinder from lock to lock, must increase in comparison to do this test with normal pump supply.

Without pump supply the number of turns must match cylinder volume/displacement of OSPBX.

Cylinder volume: 4000 ccm and OSPBX 200 LS greater than number of turns must be 4000/200 which is approximately or equal to 20 turns.

Products we offer:

- Bent Axis Motors
- Closed Circuit Axial Piston Pumps and Motors
- Displays
- Electrohydraulic Power Steering
- Electrohydraulics
- Hydraulic Power Steering
- Integrated Systems
- Joysticks and Control Handles
- Microcontrollers and Software
- Open Circuit Axial Piston Pumps
- Orbital Motors
- PLUS+1® GUIDE
- Proportional Valves
- Sensors
- Steering
- Transit Mixer Drives

Danfoss Power Solutions is a global manufacturer and supplier of high-quality hydraulic and electronic components. We specialize in providing state-of-the-art technology and solutions that excel in the harsh operating conditions of the mobile off-highway market. Building on our extensive applications expertise, we work closely with our customers to ensure exceptional performance for a broad range of off-highway vehicles.

We help OEMs around the world speed up system development, reduce costs and bring vehicles to market faster.

Danfoss – Your Strongest Partner in Mobile Hydraulics.

Go to www.powersolutions.danfoss.com for further product information.

Wherever off-highway vehicles are at work, so is Danfoss. We offer expert worldwide support for our customers, ensuring the best possible solutions for outstanding performance. And with an extensive network of Global Service Partners, we also provide comprehensive global service for all of our components.

Please contact the Danfoss Power Solution representative nearest you.

Comatrol

www.comatrol.com

Schwarzmueller-Inverter

www.schwarzmueller-inverter.com

Turolla

www.turollaocg.com

Hydro-Gear

www.hydro-gear.com

Daikin-Sauer-Danfoss

www.daikin-sauer-danfoss.com

Local address:

Danfoss Power Solutions (US) Company
2800 East 13th Street
Ames, IA 50010, USA
Phone: +1 515 239 6000

Danfoss Power Solutions GmbH & Co. OHG
Krokamp 35
D-24539 Neumünster, Germany
Phone: +49 4321 871 0

Danfoss Power Solutions ApS
Nordborgvej 81
DK-6430 Nordborg, Denmark
Phone: +45 7488 2222

Danfoss Power Solutions Trading (Shanghai) Co., Ltd.
Building #22, No. 1000 Jin Hai Rd
Jin Qiao, Pudong New District
Shanghai, China 201206
Phone: +86 21 3418 5200

Danfoss can accept no responsibility for possible errors in catalogues, brochures and other printed material. Danfoss reserves the right to alter its products without notice. This also applies to products already on order provided that such alterations can be made without changes being necessary in specifications already agreed. All trademarks in this material are property of the respective companies. Danfoss and the Danfoss logotype are trademarks of Danfoss A/S. All rights reserved.