

SEMiX241DH16s



SEMiX® 13

Bridge Rectifier Module (halfcontrolled)

SEMiX241DH16s

Features

- Terminal height 17 mm
- Chips soldered directly to isolated substrate
- UL recognised file no. E63532

Typical Applications*

- Input Bridge Rectifier for AC/DC motor control
- Power supply

Remarks

- For storage and case temperature with TIM see document "TP(*) SEMiX 13"

Absolute Maximum Ratings				
Symbol	Conditions		Values	Unit
Module				
I_D	$T_j = 130\text{ °C}$ rec. 120 °C	$T_c = 85\text{ °C}$	392	A
		$T_c = 100\text{ °C}$	298	A
T_{stg}	module without TIM		-40 ... 125	°C
V_{isol}	AC sinus 50Hz, $t = 1\text{ min}$		4000	V

Absolute Maximum Ratings				
Symbol	Conditions		Values	Unit
Thyristor				
$I_{T(AV)}$	$T_j = 130\text{ °C}$ sinus 180 °	$T_c = 85\text{ °C}$	138	A
		$T_c = 100\text{ °C}$	104	A
I_{TSM}	10 ms	$T_j = 25\text{ °C}$	2000	A
		$T_j = 130\text{ °C}$	1800	A
i^2t	10 ms	$T_j = 25\text{ °C}$	20000	A ² s
		$T_j = 130\text{ °C}$	16200	A ² s
V_{RSM}			1700	V
V_{RRM}			1600	V
V_{DRM}			1600	V
$(di/dt)_{cr}$	$T_j = 130\text{ °C}$		100	A/μs
$(dv/dt)_{cr}$	$T_j = 130\text{ °C}$		1000	V/μs
T_j			-40 ... 130	°C

Absolute Maximum Ratings				
Symbol	Conditions		Values	Unit
Diode				
I_{FAV}	$T_j = 150\text{ °C}$ sin. 180 °	$T_c = 85\text{ °C}$	160	A
		$T_c = 100\text{ °C}$	135	A
I_{FSM}	10 ms	$T_j = 25\text{ °C}$	2000	A
		$T_j = 150\text{ °C}$	1650	A
i^2t	10 ms	$T_j = 25\text{ °C}$	20000	A ² s
		$T_j = 150\text{ °C}$	13612	A ² s
V_{RSM}			1700	V
V_{RRM}			1600	V
T_j			-40 ... 150	°C

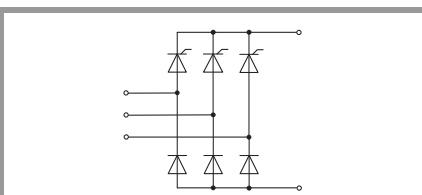

DH



SEMiX® 13

Bridge Rectifier Module (halfcontrolled)

SEMiX241DH16s

Features

- Terminal height 17 mm
- Chips soldered directly to isolated substrate
- UL recognised file no. E63532

Typical Applications*

- Input Bridge Rectifier for AC/DC motor control
- Power supply

Remarks

- For storage and case temperature with TIM see document "TP(*) SEMiX 13"

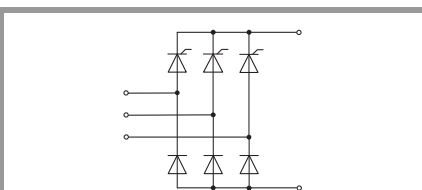

DH

Characteristics					
Symbol	Conditions	min.	typ.	max.	Unit
Thyristor					
V_T	$T_j = 130\text{ °C}$, $I_T = 300\text{ A}$, chiplevel		1.40	1.53	V
$V_{T(TO)}$	$T_j = 130\text{ °C}$, chiplevel		0.84	0.85	V
r_T	$T_j = 130\text{ °C}$, chiplevel		1.85	2.3	mΩ
$I_{DD}; I_{RD}$	$T_j = 130\text{ °C}$, $V_{DD} = V_{DRM}$; $V_{RD} = V_{RRM}$			21	mA
t_{gd}	$T_j = 25\text{ °C}$, $I_G = 1\text{ A}$, $di_G/dt = 1\text{ A}/\mu\text{s}$		1		μs
t_{gr}	$V_D = 0.67 \cdot V_{DRM}$		2		μs
t_q	$T_j = 130\text{ °C}$		150		μs
I_H	$T_j = 25\text{ °C}$			220	mA
I_L	$T_j = 25\text{ °C}$, $R_G = 33\text{ Ω}$			550	mA
V_{GT}	$T_j = 25\text{ °C}$, d.c.	2			V
I_{GT}	$T_j = 25\text{ °C}$, d.c.	100			mA
V_{GD}	$T_j = 130\text{ °C}$, d.c.			0.25	V
I_{GD}	$T_j = 130\text{ °C}$, d.c.			3.8	mA
$R_{th(j-c)}$	per thyristor, sin. 180°			0.2	K/W
$R_{th(c-s)}$	per thyristor ($\lambda_{grease}=0.81\text{ W}/(\text{m}^2\text{K})$)		0.072		K/W
$R_{th(c-s)}$	per thyristor, pre-applied phase change material		0.05		K/W

Characteristics					
Symbol	Conditions	min.	typ.	max.	Unit
Diode					
V_F	$I_F = 300\text{ A}$ chiplevel	$T_j = 25\text{ °C}$	1.22	1.63	V
		$T_j = 125\text{ °C}$	1.21	1.59	V
$V_{(TO)}$	chiplevel	$T_j = 25\text{ °C}$	0.88	0.98	V
		$T_j = 125\text{ °C}$	0.73	0.83	V
r_T	chiplevel	$T_j = 25\text{ °C}$	1.13	2.2	mΩ
		$T_j = 125\text{ °C}$	1.60	2.5	mΩ
I_{RD}	$T_j = 145\text{ °C}$, $V_{RD} = V_{RRM}$			1.1	mA
$R_{th(j-c)}$	per diode, sin. 180°			0.22	K/W
$R_{th(c-s)}$	per Diode ($\lambda_{grease}=0.81\text{ W}/(\text{m}^2\text{K})$)		0.075		K/W
$R_{th(c-s)}$	per Diode, pre-applied phase change material		0.063		K/W

Characteristics					
Symbol	Conditions	min.	typ.	max.	Unit
Module					
L_{CE}			20		nH
R_{CC+EE}	measured per switch	$T_C = 25\text{ °C}$	0.7		mΩ
		$T_C = 125\text{ °C}$	1		mΩ
$R_{th(c-s)1}$	calculated without thermal coupling		0.012		K/W
$R_{th(c-s)2}$	including thermal coupling, Ts underneath module ($\lambda_{grease}=0.81\text{ W}/(\text{m}^2\text{K})$)		0.018		K/W
$R_{th(c-s)2}$	including thermal coupling, Ts underneath module, pre-applied phase change material		0.014		K/W
M_s	to heat sink (M5)	3		5	Nm
M_t	to terminals (M6)	2.5		5	Nm
w				350	g

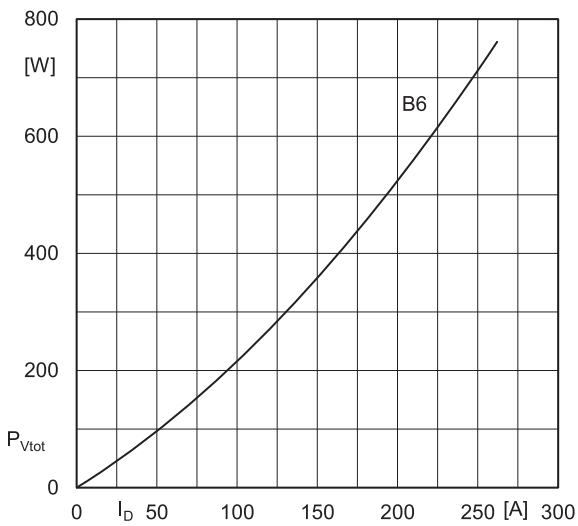

Fig. 4L: Power dissipation per module vs. direct current

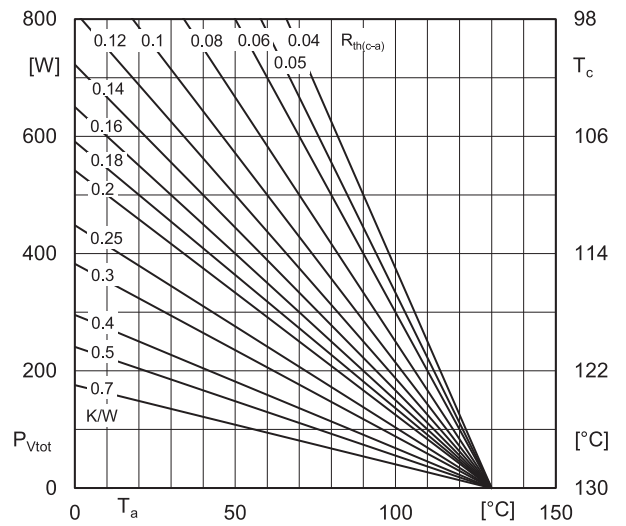

Fig. 4R: Power dissipation per module vs. ambient temperature

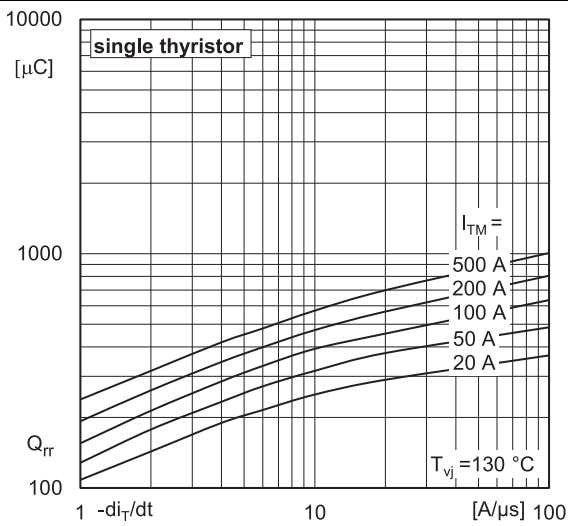

Fig. 5: Recovered charge vs. current decrease

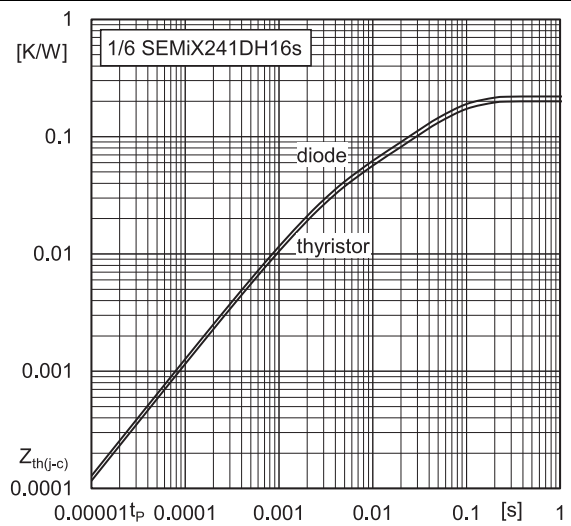

Fig. 6: Transient thermal impedance vs. time

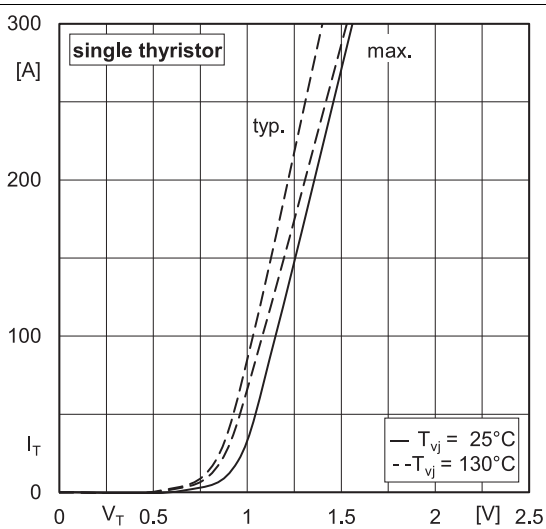

Fig. 7: On-state characteristics

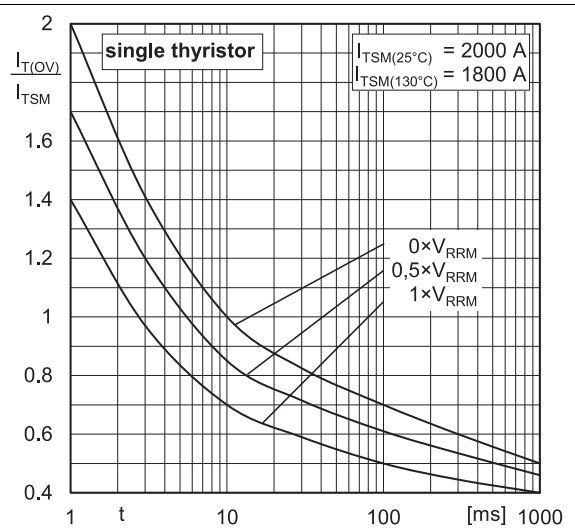

Fig. 8: Surge overload current vs. time

SEMiX241DH16s

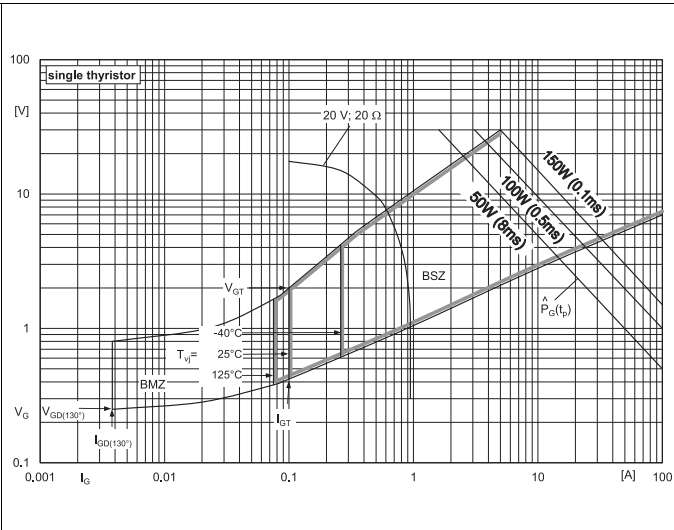
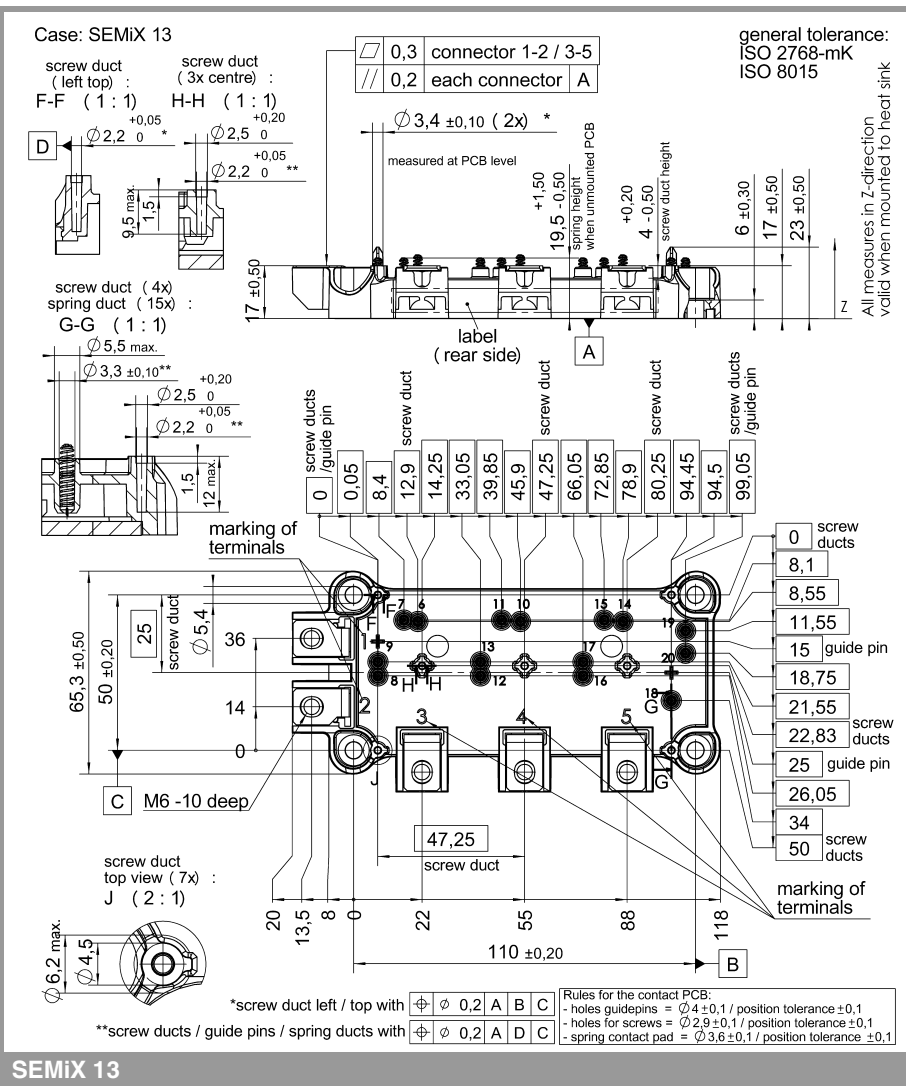

Fig. 9: Gate trigger characteristics



typical applications, which may still vary depending on the specific application. Therefore, products must be tested for the respective application in advance. Application adjustments may be necessary. The user of SEMIKRON products is responsible for the safety of their applications embedding SEMIKRON products and must take adequate safety measures to prevent the applications from causing a physical injury, fire or other problem if any of SEMIKRON products become faulty. The user is responsible to make sure that the application design is compliant with all applicable laws, regulations, norms and standards. Except as otherwise explicitly approved by SEMIKRON in a written document signed by authorized representatives of SEMIKRON, SEMIKRON products may not be used in any applications where a failure of the product or any consequences of the use thereof can reasonably be expected to result in personal injury. No representation or warranty is given and no liability is assumed with respect to the accuracy, completeness and/or use of any information herein, including without limitation, warranties of non-infringement of intellectual property rights of any third party. SEMIKRON does not assume any liability arising out of the applications or use of any product; neither does it convey any license under its patent rights, copyrights, trade secrets or other intellectual property rights, nor the rights of others. SEMIKRON makes no representation or warranty of non-infringement or alleged non-infringement of intellectual property rights of any third party which may arise from applications. Due to technical requirements our products may contain dangerous substances. For information on the types in question please contact the nearest SEMIKRON sales office. This document supersedes and replaces all information previously supplied and may be superseded by updates. SEMIKRON reserves the right to make changes.