

SEMITOP® 2

Bridge Rectifier

SK 95 D

Preliminary Data

Features

- Compact design
- One screw mounting
- Heat transfer and insulation through direct copper bonded aluminium oxide ceramic (DCB)
- Up to 1600V reverse voltage
- High surge currents
- Glass passivated diodes chips
- UL recognized, file no. E 63 532

Typical Applications

- Input rectifier for power supplies
- Rectifier

V_{RSM} V	V_{RRM}, V_{DRM} V	$I_D = 95$ A (full conduction) ($T_s = 80$ °C)
800	800	SK 95 D 08
1200	1200	SK 95 D 12
1600	1600	SK 95 D 16

Symbol	Conditions	Values	Units
I_D	$T_s = 80$ °C	95	A
I_{FSM}	$T_{vj} = 25$ °C; 10 ms $T_{vj} = 150$ °C; 10 ms	700 560	A A
i^2t	$T_{vj} = 25$ °C; 8,3...10 ms $T_{vj} = 150$ °C; 8,3...10 ms	2450 1370	A ² s A ² s
V_F	$T_{vj} = 25$ °C; $I_F = 35$ A	max. 1,2	V
$V_{(TO)}$	$T_{vj} = 150$ °C	max. 0,8	V
r_T	$T_{vj} = 150$ °C	max. 11	mΩ
I_{RD}	$T_{vj} = 150$ °C; $V_{DD} = V_{DRM}; V_{RD} = V_{RRM}$	max. 4	mA mA
$R_{th(f-s)}$	per diode per module	1,2 0,2	K/W K/W
T_{solder}	terminals, 10s	260	°C
T_{vj}		-40...+150	°C
T_{stg}		-40...+125	°C
V_{isol}	a. c. 50 Hz; r.m.s.; 1 s / 1 min.	3000 (2500)	V
M_s	mounting torque to heatsink	2	Nm
M_t			
m	approx. weight	19	g
Case	SEMITOP® 2	T 7	

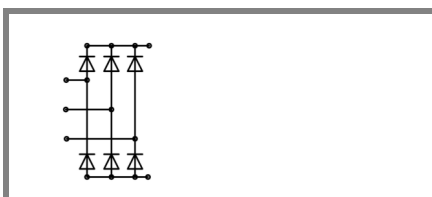

D

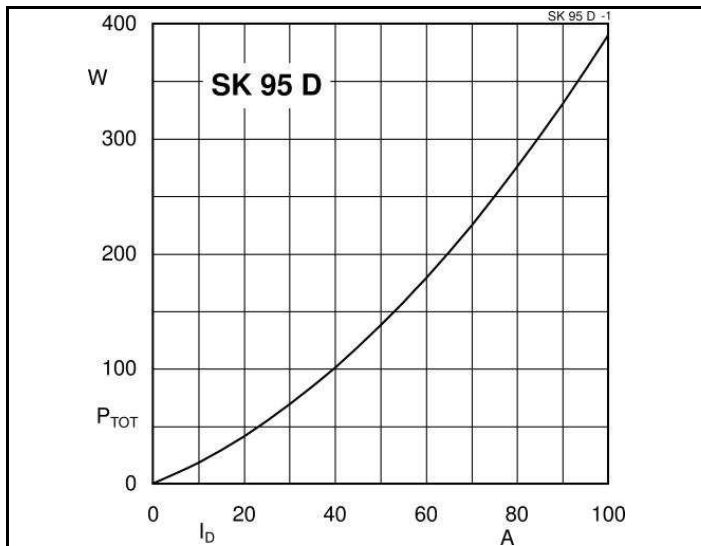

Fig. 1 Power dissipation vs. Output current

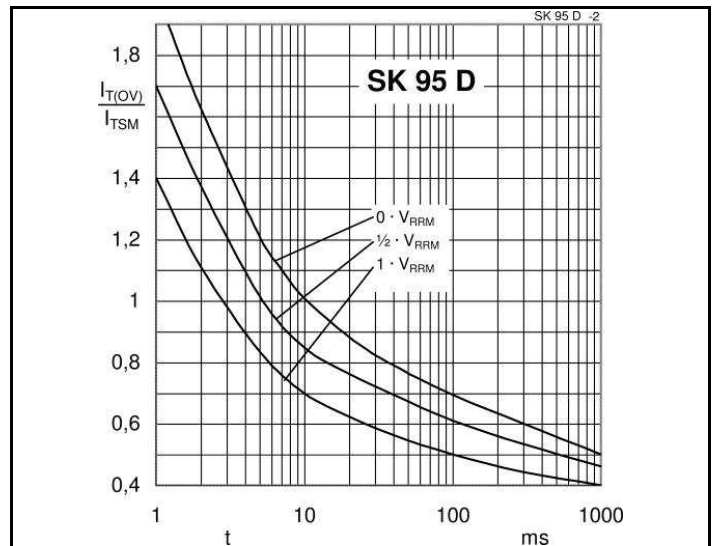

Fig. 2 Surge overload current vs. time

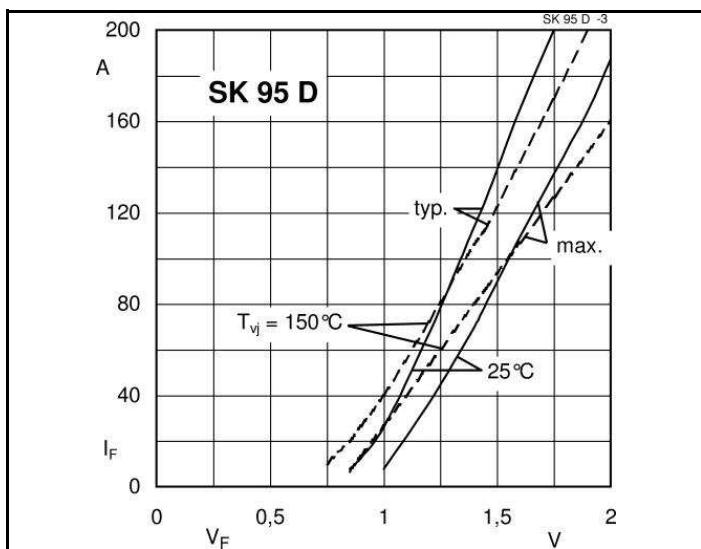

Fig. 3 Forward characteristics of single diode

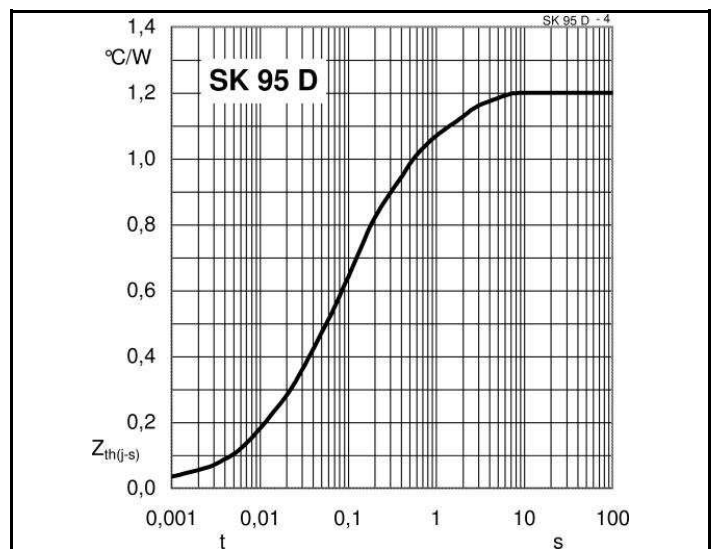
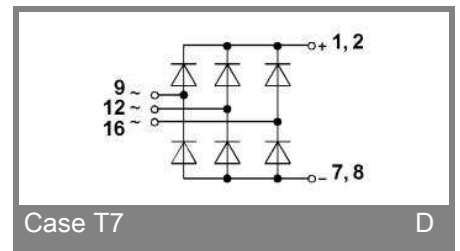
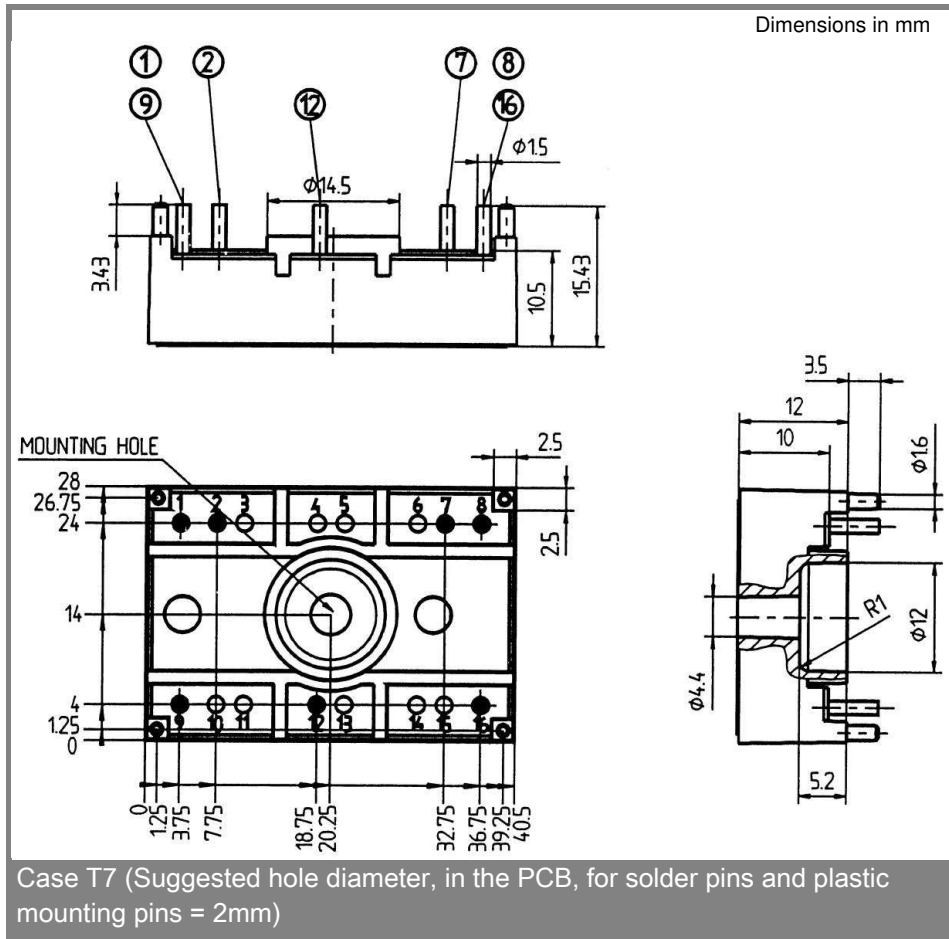

Fig. 4 Thermal transient impedance vs. time



This technical information specifies semiconductor devices but promises no characteristics. No warranty or guarantee expressed or implied is made regarding delivery, performance or suitability.