

User Guide

Controller for condensing unit Optyma™ Plus

SW Ver. 3.7x

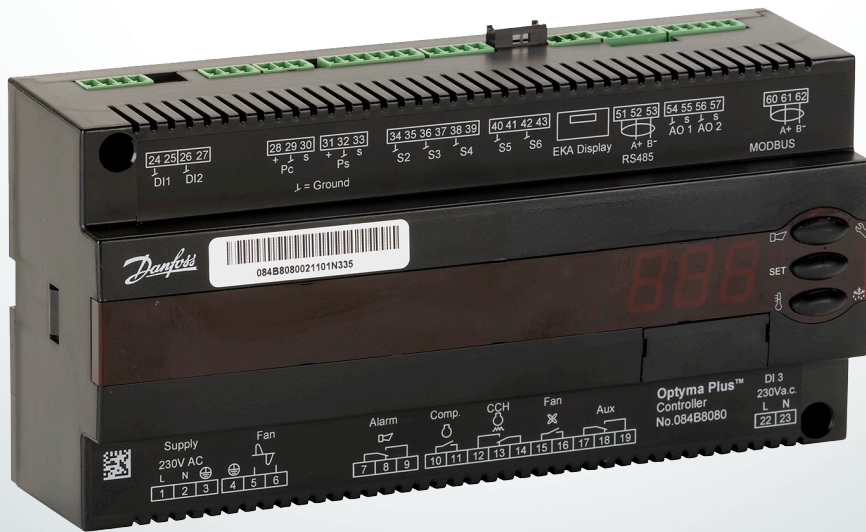

Introduction

Application

Condensing unit control

Advantages

- Condensing pressure control in relation to outside temperature
- Fan variable speed regulation
- On/off or variable speed regulation of the compressor
- Heating element control in crankcase
- Day/night controller operation
- Built-in clock function with power reserve
- Built-in Modbus data communication
- Monitoring discharge temperature t_d
- Oil return management control at variable speed control

Principle

The controller receives a signal for demanded cooling, and it then starts the compressor.

If the compressor is controlled by variable speed, the suction pressure (converted to temperature) will be controlled according to a set temperature value.

Condenser pressure regulation is performed again following a signal from the ambient temperature sensor and the set reference. The controller will then control the fan, which allows the condensing temperature to be maintained at the desired value.

The controller can also control the heating element in the crankcase so that oil is kept separate from the refrigerant.

For excess discharge temperature, the liquid injection will be activated in the suction line (for compressors with the liquid injection option).

Functions

- Control of condensing temperature
- Control of fan speed
- On/off control or speed regulation of the compressor
- Control of heating element in crankcase
- Liquid injection into economizer port (if possible)
- Raising the condenser pressure regulation reference during night operation
- Extern start/stop via DI1
- Safety cut-out activated via signal from automatic safety control

Regulation reference for condensing temperature

The controller controls the condensing Reference, which is in detail the difference between condensing temperature and ambient temperature. The reference setpoint can be shown with a brief push on the middle button and adjusted with the upper and lower button. The reference can be raised at night to allow slower fan speeds to reduce fan noise. This is done via the night set back feature.

This setting can be changed without entering the programming mode so care needs to be taken to not adjust unintentionally.

Day/Night

The controller has an internal clock function which changes between daytime and night operation.

During night operation, the reference is raised by the 'Night offset' value.

This day/night signal can also be activated in two other ways:

- Via an on/off input signal - DI2
- Via data communication.

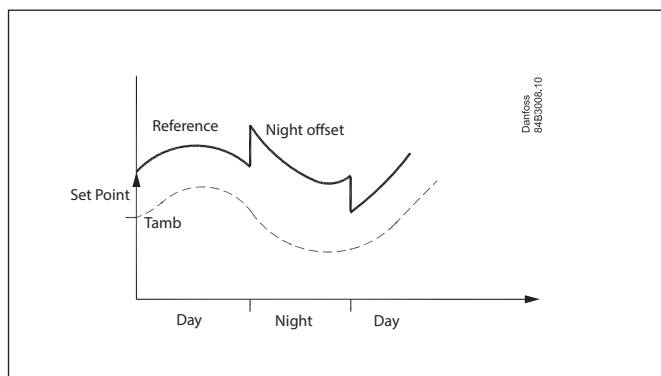
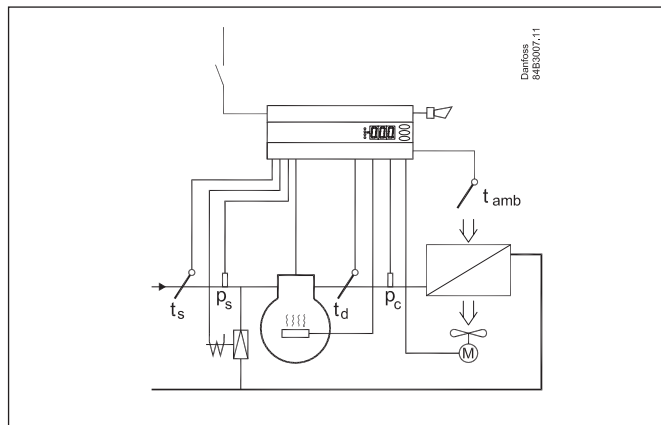

Fan operation

The controller will control the fan so that the condensing temperature is maintained at the desired value above the outdoor temperature.

The user may select from different ways to control the fan:

- **Internal speed regulation**
Here the fan is speed-controlled via terminal 5-6. At a need of 95% and above, the relay on terminal 15-16 are activated, while 5-6 are deactivated.
- **External speed regulation**
For larger fan motors with insufficient internal outlet, an external speed regulation can be connected to terminal 54-55. A 0 – 10 V signal indicating the desired speed is then sent from this point. The relay on terminal 15-16 will be active when the fan is in operation.

In menu 'F17' the user can define which of the two controls to use.

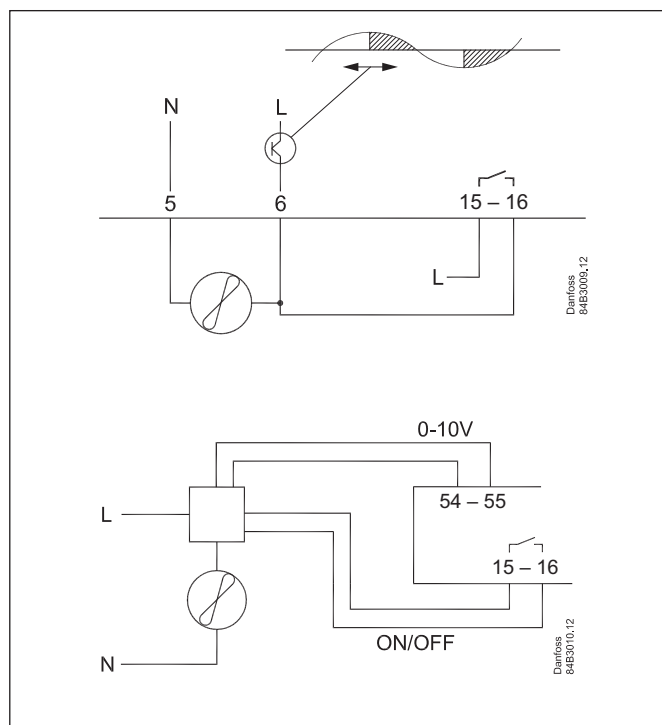

Fan speed at start

When the fan is re-started after an idle period, it will be started at a speed that is set in the 'Jog Speed' function. This speed is maintained for 10 seconds, after which the speed changes to the regulation need.

Fan speed at low loads

At low loads between 10 and 30%, the speed will remain at that which is set in the 'FanMinSpeed' function.

Fan speed at low ambient temperatures

To avoid frequent start/stops in low ambient temperatures in which the fan's capacity is high, the internal amplification factor is lowered. This provides a smoother regulation.

The 'Jog speed' is also lowered in the area from 10 °C and down to -20 °C.

At temperatures below -20 °C the 'Jog Low' value can be used.

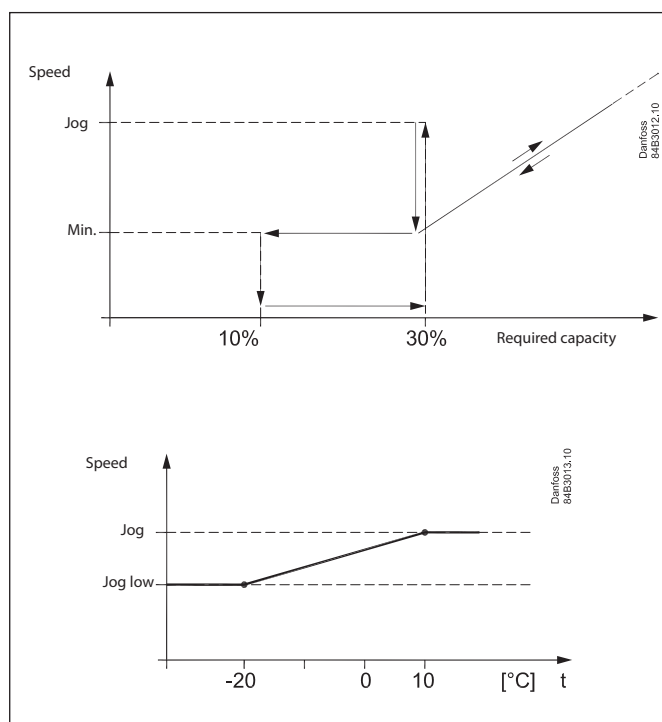

Compressor compartment pre-ventilation

The condenser fan starts and operates for a period of time and speed before the compressor starts. This happens in case of any mildly flammable refrigerant selected via "o30 Refrigerant", to get a safe atmosphere while sucking potential flammable A2L-refrigerant gas out of the compressor compartment.

There is a fixed delay of about 8 seconds between this pre-ventilation and compressor start in order to reduce the airflow significantly and avoid any condensing problems on low ambient temperatures.

Compressor control

The compressor is controlled by a signal at the DI1 input. The compressor will start once the input is connected. Three restrictions have been implemented to avoid frequent start/stops:

- One for minimum ON time
- One for minimum OFF time
- One for how much time must elapse between two starts.

These three restrictions have the highest priority during regulation, and the other functions will wait until they are complete before regulation can continue. When the compressor is 'locked' by a restriction, this can be seen in a status notification.

If the DI3 input is used as a safety stop for the compressor, an insufficient input signal will immediately stop the compressor. Variable speed compressors can be speed-controlled with a voltage signal at the AO2 output. If this compressor has been running for a long period at low speed, the speed is increased for a short moment for the purpose of oil-return.

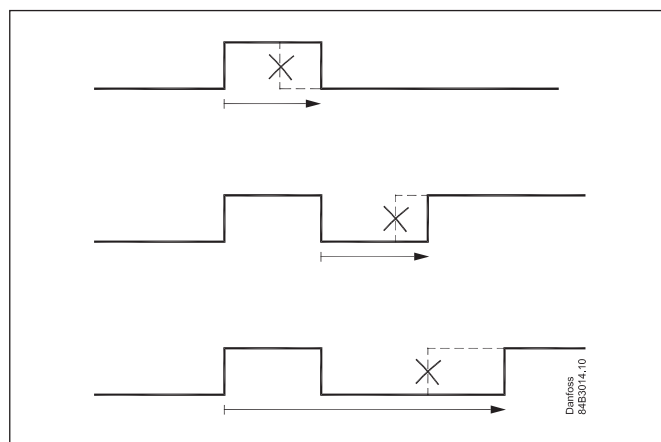

Maximum discharge gas temperature

The temperature is recorded by sensor Td.

If variable speed control is chosen for the compressor, this control will initially reduce the compressor capacity if the Td temperature approaches the set maximum value.

If a higher temperature is detected than the set max. temperature, the fan's speed will be set to 100%. If this does not cause the temperature to drop, and if the temperature remains high after the set delay time, the compressor will be stopped. The compressor will only be re-started once the temperature is 10 K lower than the set value. The above mentioned re-start restrictions must also be complete before the compressor can start once again.

If the delay time is set to '0', the function will **not** stop the compressor. The Td sensor can be deactivated (o63).

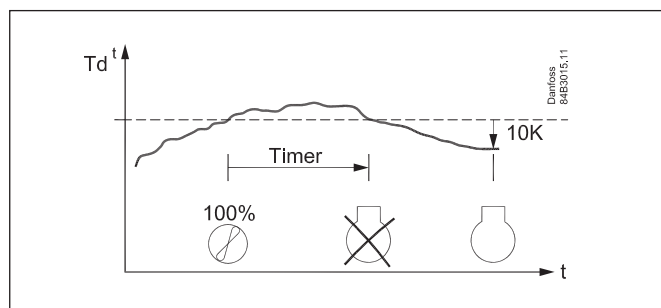

Liquid injection into economizer port

The controller can activate the liquid injection into economizer port if the discharge temperature is approaching the maximum allowable temperature.

Note: Liquid injection function use the Aux Relay if the relay is configured to this function.

High pressure monitoring

During regulation, the internal high pressure monitoring function is able to detect an over the limit condensing pressure so that the regulation can continue.

However, if the c73 setting is exceeded, the compressor will be stopped and an alarm is triggered.

If, on the other hand, the signal comes from the interrupted safety circuit connected to DI3, the compressor will immediately be stopped and the fan will be set to 100%.

When the signal is once again 'OK' at the DI3 input, the regulation will resume.

Low pressure monitoring

During regulation, the internal low pressure monitoring function will cut out the compressor upon detecting a suction pressure that falls below the lower limit, but only once the minimum ON time is exceeded. An alarm will be issued (A2). This function will be time delayed, if the compressor starts at low ambient temperature.

Pump down limit

The compressor will be stopped if a suction pressure that falls below the set value is registered, but only once the minimum ON time is exceeded.

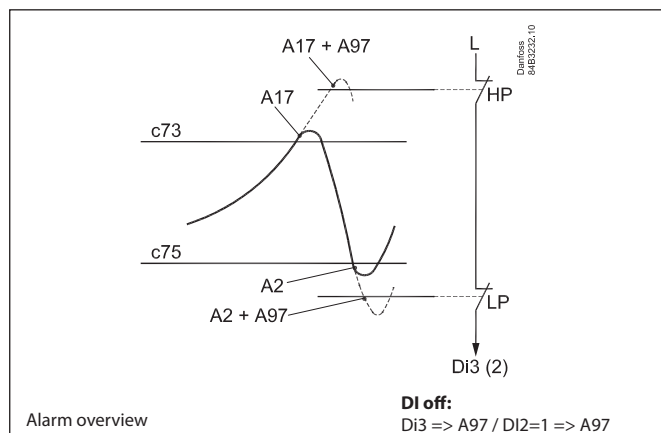

Heating element in the crankcase

The controller has a thermostat function which can control the heating element for the crankcase. Oil can thus be kept separate from the refrigerant. The function is active when the compressor has stopped.

The function is based on the ambient temperature and suction gas temperature. When the two temperatures are equal \pm a temperature difference, power will be supplied to the heating element.

The 'CCH off diff' setting indicates when power will no longer be supplied to the heating element.

The 'CCH on diff' indicates when 100% power will be sent to the heating element.

Between the two settings the controller calculates the wattage and connects to the heating element in a pulse/pause cycle which corresponds to the desired wattage.

The Taux sensor can be used to record the temperature in the crankcase if desired.

When the Taux sensor records a temperature lower than $T_s + 10$ K, the heating element will be set to 100%, but only if the ambient temperature is below 0°C .

Separate thermostat function

The taux sensor can also be used in a heating function with programmable temperature. Here, the AUX relay will connect the heating element.

Digital inputs

There are two digital inputs DI1 and DI2 with contact function and one digital input DI3 with high voltage signal.

They can be used for the following functions:

DI1: Starts and stops compressor

DI2: Here the user can select from various functions

Signal from an external safety function

External main switch / night setback signal / separate alarm function / Monitoring of input signal / signal from an external speed control

DI3: Safety signal from low/high-pressure switch

Data communication

The controller is delivered with built-in MODBUS data communication.

If a different form of data communication is requested, a LON RS-485 module can be inserted in the controller.

The connection will then be made on terminal RS 485.

Important

All connections to the data communication must comply with the requirements for data communication cables.

See literature: RC8AC.

Display

The controller has one plug for a display. Here display type EKA 163B or EKA 164B (max. length 15 m) can be connected.

EKA 163B is a display for readings.

EKA 164B is both for readings and operation.

The connection between display and controller must be with a cable which has a plug at both ends.

A setting can be made to determine whether the T_c or T_s is to be read out. When the value is read out, the second read-out can be displayed by briefly pressing the lower button.

When a display is to be connected to the built-in MODBUS, the display can advantageously be changed to one of the same type, but with Index A (version with screw terminals).

The controllers address must be set higher than 0 in order for the display to be able to communicate with the controller.

If connection of two displays is required, one must be connected to the plug (max. 15 m) and the other must then be connected to the fixed data communication.

Override

The controller contains a functions which can be used together with the override function in the master gateway/system manager.

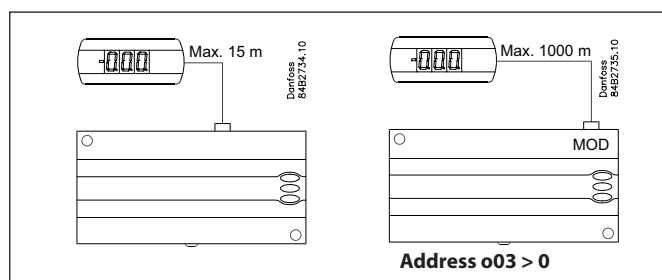
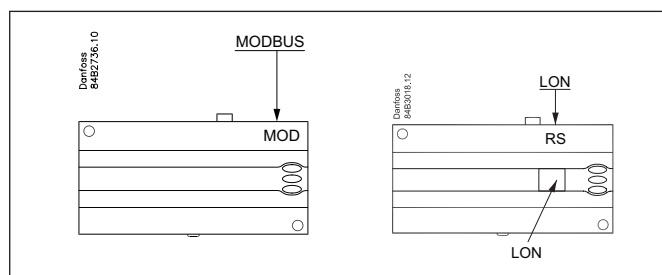
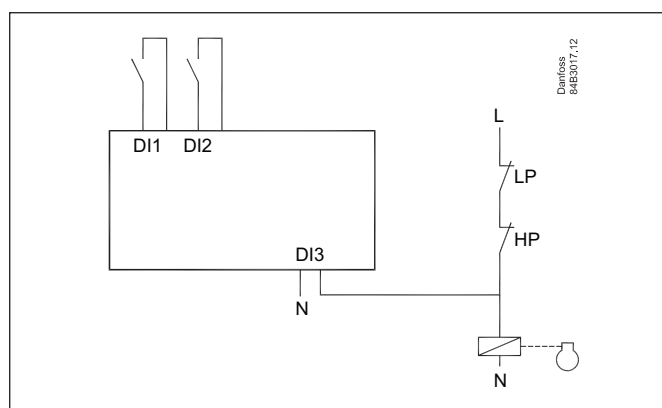
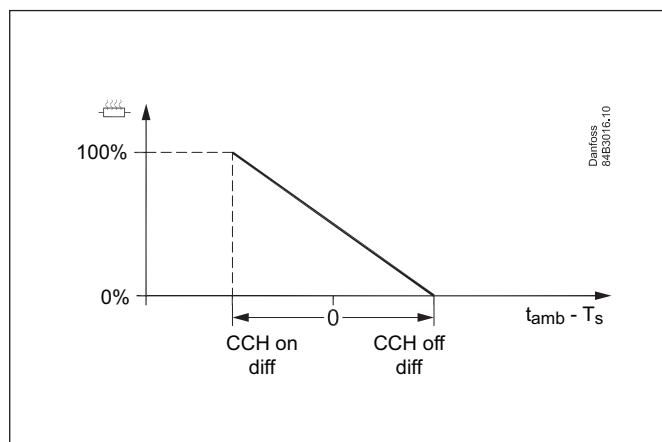

Function via data communication	Day/Night schedule
Function in gateway/system manager	Day/Night control / Time schedule
Used parameters in Optyma™ Plus	--- Night setback

Survey of functions

Function	Parameter	Parameter by operation via data communication
Normal display		
The display shows the temperature value for the suction pressure Ts or from the condensing pressure Tc. Enter which of the two are to be displayed in o17. During operation, when one of the two is shown in the display, the other value can be seen by pressing and holding in the lower button.		Ts / Tc
Thermostat		
Thermostat control		
Set point The controller's reference Tc is the outside temperature + set point + any applicable offset. Enter the set point by pressing the middle button. A offset can be entered in r13.		Reference
Unit Set here if the display is to show SI-units or US-units 0: SI (°C and bar) 1: US (°F and Psig).	r05	Unit °C=0. / °F=1 (Only °C on AKM, whatever the setting)
Start / stop of refrigeration With this setting refrigeration can be started, stopped or a manual override of the outputs can be allowed. (For manual control the value is set at -1. Then the relay outlets can be force-controlled by the respective reading parameters (u58, u59 etc.). Here the read value can be overwritten.) Start / stop of refrigeration can also be accomplished with the external switch function connected to a DI input. If the external switch function is deselected, the input must be shorted. Stopped refrigeration will give a "Standby alarm".	r12	Main Switch 1: Start 0: Stop -1: Manual control of outputs allowed
Night setback value The controller reference is raised by this value when the controller switches to night operation.	r13	Night offset
Reference Ts Here the reference is entered for the suction pressure Ts in degrees (only for Optyma™ Plus inverter)	r23	Ts Ref
Reference Tc Here the current controller reference for condensing pressure Tc can be read out in degrees.	r29	Tc Ref
External heating function Thermostat cut-in value for an external heating element (only when 069=2 and o40=1) The relay activates when the temperature reaches the set value. Relay releases again when the temperature has increased by 5 K (the difference is set at 5 K).	r71	AuxTherRef
Minimum condensing temperature (lowest permitted regulation reference) Here the lowest permitted reference is entered for the condensing temperature Tc.	r82	MinCondTemp
Maximum condensing temperature (highest permitted regulation reference) Here the highest permitted reference is entered for the condensing temperature Tc.	r83	MaxCondTemp
Maximum discharge gas temperature Here the highest permitted discharge gas temperature is entered. The temperature is measured by sensor Td. If the temperature is exceeded, the fan will be started at 100%. A timer is also started which can be set in c72. If the timer setting runs out, the compressor will be stopped and an alarm will be issued. The compressor will be reconnected 10 K below the cut-out limit, but only after the compressor's off timer has expired.	r84	MaxDischTemp
		Night setback (start of night signal. 0=Day, 1=Night)
Alarm		
Alarm settings		
The controller can give alarm in different situations. When there is an alarm all the light-emitting diodes (LED) will flash on the controller front panel, and the alarm relay will cut in.		With data communication the importance of the individual alarms can be defined. Setting is carried out in the "Alarm destinations" menu via AKM.
Delay of a DI2 alarm A cut-out/cut-in input will result in alarm when the time delay has been passed. The function is defined in o37.	A28	AI.Delay DI2
High condensing temperature alarm limit The limit for the condensing temperature, set as difference above the instant reference (parameter r29), at which the A80 Alarm is activated after expired delay (see parameter A71). Parameter is set in Kelvin .	A70	Air flowDiff
Delay time for alarm A80 - see also parameter A70. Set in minutes.	A71	Air flow del
		Reset alarm
		Ctrl. Error

Compressor		Compressor control
<p>The start/stop of the controller can be defined in several ways. Internal only: Here, only the internal main switch in r12 is used. External: Here, input DI1 is used as a thermostat switch. With this setting, input DI2 can be defined as an 'external safety' mechanism that can stop the compressor.</p>		
<p>Running times To prevent irregular operation, values can be set for the time the compressor is to run once it has been started. And for how long it at least has to be stopped.</p>		
<p>Min. ON-time (in seconds)</p>	c01	Min. On time
<p>Min. OFF-time (in seconds)</p>	c02	Min. Off time
<p>Minimum time between cut-in of relay (in minutes)</p>	c07	Restart time
<p>Pump down Limit Pressure value at which the compressor stops</p>	c33	PumpDownLim
<p>Compressor min. speed Here the minimum allowable speed for the compressor is set.</p>	c46	CmpMinSpeed
<p>Compressor start speed The compressor will not start before the required speed can be achieved</p>	c47	CmpStrSpeed
<p>Compressor max. speed Upper limit for compressor speed</p>	c48	CmpMaxSpeed
<p>Compressor max. speed during night operation Upper limit for compressor speed during night operation. During night operation, the c48 value is reduced to the percentage value set here</p>	c69	CmpMax % NgT
<p>Definition of compressor control mode 0: No compressor - Condensing unit OFF 1: Fixed speed - Input DI1 used to start / stop of fixed speed compressor 2: Variable speed - Input DI1 used for start / stop of variable speed-controlled compressor with a 0 – 10 V signal on AO2</p>	c71	Comp mode
<p>Delay time for high discharge gas temperature (in minutes) When sensor Td records a temperature higher than the limit value entered in r84, the timer will start. When the delay time expires, the compressor will be stopped if the temperature is still too high. An alarm will also be issued.</p>	c72	Disch. Del
<p>Max. pressure (Max. condensing pressure) The maximum permitted condensing pressure is set here. If the pressure increases, the compressor will be stopped.</p>	c73	PcMax
<p>Difference for max. pressure (Condensing pressure) Difference for re-start of compressor if it is cut out due to PcMax. (All timers must expire before re-start is permitted)</p>	c74	Pc Diff
<p>Minimum suction pressure Enter the lowest permitted suction pressure here. The compressor is stopped if the pressure drops below the minimum value.</p>	c75	PsLP
<p>Suction pressure difference Difference for re-start of compressor if it is cut out due to PsLP. (All timers must expire before re-start is permitted)</p>	c76	PsDiff
<p>Amplification factor Kp for compressor regulation If the Kp value is lowered, the regulation will be slower</p>	c82	Cmp Kp
<p>Integration time Tn for compressor regulation If the Tn value is increased, regulation will run more smoothly</p>	c83	Comp Tn sec
<p>Liquid Injection Offset The liquid injection relay is activated when the temperature is over "r84" minus "c88" (but only if the compressor is running).</p>	c88	LI Offset
<p>Liquid Injection hysteresis The liquid injection relay is then deactivated when the temperature has dropped to "r84" minus "c88" minus "c89".</p>	c89	LI Hyst
<p>Compressor stop delay after Liquid injection Compressor ON-time after relay "Aux relay" is went OFF</p>	c90	LI Delay
<p>Desired compressor speed in connection with pressure transmitter faults. Speed during emergency operation.</p>	c93	CmpEmrgSpeed
<p>Min On time during Low Ambient Temperature and Low Pressure</p>	c94	c94 LpMinOnTime
<p>Measured Tc for which the Comp min speed is raised to StartSpeed</p>	c95	c95 TcSpeedLim
<p>The LED on the controller's front will show whether refrigeration is in progress.</p>		

Fan		Fan control
Amplification factor Kp If the KP value is lowered, the fan speed will change.	n04	Kp factor
Integration Time Tn If the Tn value is increased, the fan speed will change.	n05	Tn sec
Amplification factor Kp max The regulation uses this Kp, when the measured value is far from reference	n95	Cmp kp Max
Fan speed The actual fan speed is read out here as a % of nominal speed.	F07	Fan Speed %
Change in fan speed A permitted change in fan speed can be entered for when the fan speed is to be lowered. The setting can be entered as a percentage value per second.	F14	DownSlope
Jog speed Set the fan's start-up speed here. After ten seconds the function jog function will stop and the fan speed will then be controlled by the normal regulation.	F15	Jog Speed
Jog speed at low temperatures Enter the desired jog speed for outside temperatures of -20 °C and lower here. (For outside temperatures between +10 and -20, the controller will calculate and utilise a speed between the two jog settings.)	F16	LowTempJog
Fan control definition 0: Off 1: The fan is connected to terminal 5-6 and is speed-controlled by an internal phase cut. The relay on terminal 15-16 connects at speed requirements of 95% or higher. 2: The fan is connected to an external speed control device. The speed control signal is connected to terminals 28-29. The relay on terminal 15-16 will connect when regulation is required. (During external control, the settings F14, F15 and F16 will remain in force)	F17	FanCtrlMode
Minimum fan speed Set the lowest permitted fan speed here. The fan will be stopped if the user enters a lower speed.	F18	MinFanSpeed
Maximum fan speed The fan's top speed can be limited here. The value can be entered by setting the nominal speed of 100% to the desired percentage.	F19	MaxFanSpeed
Manual fan speed control An override of the fan speed control can be performed here. This function is only relevant when the main switch is in service mode.	F20	Manual Fan %
Phase compensation The value minimises the electrical noise emitted during phase control. The value should only be changed by specially trained staff.	F21	Fan Comp
The condenser fan will pre-ventilate the compressor compartment to ensure a safe environment before compressor start on selected A2L-refrigerants via o30	F23	FanVent Time
The LED on the controller's front will show whether Fan is in progress supplied either through fan speed control output or fan relay.		
Real time clock		
When using data communication the clock is automatically adjusted by the system unit. If the controller is without data communication, the clock will have a power reserve of four hours.		(Times cannot be set via data communication. Settings are only relevant when there is no data communication).
Switch to day operation Enter the time at which the control reference becomes the entered set point.	t17	Day start
Change to night operation Enter the time at which the control reference is raised with r13.	t18	Night start
Clock: Hour setting	t07	
Clock: Minute setting	t08	
Clock: Date setting	t45	
Clock: Month setting	t46	
Clock: Year setting	t47	
Miscellaneous		
If the controller is built into a network with data communication, it must have an address, and the system unit of the data communication must then know this address.		
The address is set between 0 and 240, depending on the system unit and the selected data communication.	o03	
The function is not used when the data communication is MODBUS. It is retrieved here via the system's scan function.	o04	

Access code 1 (Access to all settings) If the settings in the controller are to be protected with an access code you can set a numerical value between 0 and 100. If not, you can cancel the function with setting 0 (99 will always give you access).	o05	Acc. code
Controller software version	o08	SW ver
Select signal for the display Here you define the signal to be shown by the display. 1: Suction pressure in degrees, Ts. 2: Condensing pressure in degrees, Tc.	o17	Display mode
Pressure transmitter settings for Ps Working range for pressure transmitter - min. value	o20	MinTransPs
Pressure transmitter settings for Ps Working range for pressure transmitter - max. value	o21	MaxTransPs
Refrigerant setting (only if "r12" = 0) Before refrigeration is started, the refrigerant must be defined. You may choose between the following refrigerants 2=R22. 3=R134a. 13=User defined. 17=R507. 19=R404A. 20=R407C. 21=R407A. 36=R513A. 37=R407F. 40=R448A. 41=R449A. 42=R452A. 39=R1234yf. 51=R454C. 52=R455A <i>Warning: Wrong selection of refrigerant may cause damage to the compressor.</i> Other refrigerants: Here setting 13 is selected and then three factors -Ref.Fac a1, a2 and a3 - via AKM must be set.	o30	Refrigerant
Digital input signal - DI2 The controller has a digital input 2 which can be used for one of the following functions: 0: The input is not used. 1: Signal from a safety circuit (short-circuited =ok for compressor operation). Disconnected = compressor stop and A97 alarm). 2: Main switch. Regulation is carried out when the input is short-circuited, and regulation is stopped when the input is put in pos. OFF. 3: Night operation. When the input is short-circuited, there will be regulation for night operation. 4: Separate alarm function. Alarm will be given when the input is short-circuited. 5: Separate alarm function. Alarm will be given when the input is opened. 6: Input status, on or off (DI2 status can be tracked via data communication). 7: Alarm from the compressor's external speed control.	o37	DI2 config.
Aux relay function 0: The relay is not used 1: External heating element (temperature setting in r71, sensor definition in 069) 2: Used for liquid injection (temperature setting in r84) 3: Oil return management function must activate the relay	o40	AuxRelayCfg
Pressure transmitter settings for PC Working range for pressure transmitter - min. value	o47	MinTransPc
Pressure transmitter settings for PC Working range for pressure transmitter - max. value	o48	MaxTransPc
Select the type of condensing unit. Factory set. After the first setting, the value is 'locked' and can only be changed once the controller has been reset to its factory setting. When entering the refrigerant setting, the controller will ensure that the 'Unit type' and refrigerant are compatible.	o61	Unit type
S3 Configuration 0 = S3 input not used 1 = S3 input used for measuring of discharge temperature	o63	S3 config
Save as factory setting With this setting you save the controller's actual settings as a new basic setting (the earlier factory settings are overwritten).	o67	-
Define the use of the Taux sensor (S5) 0: Not used 1: Used to measure oil temperature 2: Used to measure the temperature of the external heating function 3: Other use. Measuring of optional temperature	o69	Taux Config
Period time for heating element in crankcase Within this period the controller will itself calculate an OFF and ON period. The time is entered in seconds.	P45	PWM Period
Difference for the heating elements 100% ON point The difference applies to a number of degrees below the 'Tamb minus Ts = 0 K' value	P46	CCH_OnDiff
Difference for the heating elements full OFF point The difference applies to a number of degrees above the 'Tamb minus Ts = 0 K' value	P47	CCH_OffDiff

Operating time for condensing unit The condensing unit's operating time can be read out here. The read-out value must be multiplied by 1,000 in order to obtain the correct value. (The displayed value can be adjusted if required)	P48	Unit Runtime
Operating time for the compressor The compressors operating time can be read out here. The read-out value must be multiplied by 1,000 in order to obtain the correct value. (The displayed value can be adjusted if required)	P49	Comp Runtime
Operating time for heating element in crankcase The heating element's operating time can be read out here. The read-out value must be multiplied by 1,000 in order to obtain the correct value (the displayed value can be adjusted if required).	P50	CCH Runtime
Number of HP alarms The number of HP alarms can be read out here (the displayed value can be adjusted if required).	P51	HP Alarm Cnt
Number of LP alarms The number of LP alarms can be read out here (the displayed value can be adjusted if required).	P52	LP Alarm Cnt
Number of discharge alarms The number of Td alarms can be read out here (the displayed value can be adjusted if required).	P53	DisAlarm Cnt
Number of blocked condenser alarms The number of blocked condenser alarms can be read out here (the displayed value can be adjusted if required).	P90	BlckAlrm Cnt
Oil return management Speed limit If the compressor speed exceeds this limit, a time counter will be increased. It will be decreased if the compressor speed falls down below this limit.	P77	ORM SpeedLim
Oil return management time Limit value of the above described time counter. If the counter exceeds this limit, the compressor speed will be raised to the boost speed.	P78	ORM Time
Oil return management Boost speed This compressor speed ensures that the oil returns to the compressor	P79	ORM BoostSpd
Oil return management Boost time. The time the compressor must operate at Boost speed	P80	ORM BoostTim
Service		Service
Read pressure Pc	u01	Pc bar
Read temperature Taux	u03	T_aux
Status on DI1 input. On/1=closed	u10	DI1 status
Status on night operation (on or off) on =night operation	u13	NightCond
Read Superheat	u21	Superheat SH
Read temperature at S6 sensor	u36	S6 temp
Read the compressor capacity in %	u52	CompCap %
Status on DI2 input. On/1=closed	u37	DI2 status
Status on relay for compressor	u58	Comp Relay
Status on relay for fan	u59	Fan relay
Status on relay for alarm	u62	Alarm relay
Status on relay "Aux"	u63	Aux Relay
Status on relay for heating element in crankcase	u71	CCH Relay
Status on input DI3 (on/1 = 230 V)	u87	DI3 status
Read condensing pressure in temperature	U22	Tc
Read pressure Ps	U23	Ps
Read suction pressure in temperature	U24	Ts
Read ambient temperature Tamb	U25	T_ambient
Read discharge temperature Td	U26	T_Discharge
Read suction gas temperature at Ts	U27	T_Suction
Voltage on the analogue output AO1	U44	AO_1 Volt
Voltage on the analogue output AO2	U56	AO_2 Volt

Operating status		(Measurement)
The controller goes through some regulating situations where it is just waiting for the next point of the regulation. To make these “why is nothing happening” situations visible, you can see an operating status on the display. Push briefly (1s) the upper button. If there is a status code, it will be shown on the display. The individual status codes have the following meanings:		Ctrl. state:
Normal regulation	S0	0
When the compressor is operating it must run for at least x minutes.	S2	2
When the compressor is stopped, it must remain stopped for at least x minutes.	S3	3
Refrigeration stopped by main switch. Either with r12 or a DI-input	S10	10
Manual control of outputs	S25	25
No refrigerant selected	S26	26
Safety cut-out Max. condensing pressure exceeded. All compressors stopped.	S34	34
<i>Other displays:</i>		
Password required. Set password	PS	
Regulation is stopped via main switch	OFF	
No refrigerant selected	ref	
No type has been selected for the condensing unit.	typ	

Fault message

In an error situation the LED's on the front will flash and the alarm relay will be activated. If you push the top button in this situation you can see the alarm report in the display.
 There are two kinds of error reports - it can either be an alarm occurring during the daily operation, or there may be a defect in the installation.
 A-alarms will not become visible until the set time delay has expired.
 E-alarms, on the other hand, will become visible the moment the error occurs.
 (An A alarm will not be visible as long as there is an active E alarm).
 Here are the messages that may appear:

Code / Alarm text via data communication	Description	Action
A2/--- LP alarm	Low suction pressure	See instructions for the condensing unit
A11/--- No Rfg. sel.	No refrigerant selected	Set o30
A16 /--- DI2 alarm	DI2 alarm	Check the function that sends a signal at the DI2 input
A17 / ---HP Alarm	C73 / DI3 Alarm (High / low pressure alarm)	See instructions for the condensing unit
A45 /--- Standby mode	Standby position (stopped refrigeration via r12 or DI1-input)	r12 and/or DI1 input will start the regulation
A80 / --- Cond. blocked	Air flow has decreased.	Clean the condensing unit
A96 / --- Max Disc. Temp	Discharge gas temperature is exceeded	See instructions for the condensing unit
A97 / --- Safety alarm	Safety function on DI2 or DI 3 is activated	Check the function that sends a signal at the DI2 or DI3 input and the direction of rotation of the compressor
A98 / --- Drive alarm	Alarm from speed regulation	Check speed regulation
E1 /--- Ctrl. Error	Faults in the controller	Check sensor and connection
E20 /--- Pc Sensor Err	Error on pressure transmitter Pc	
E30 /--- Taux Sensor Err	Error on Aux sensor, S5	
E31/---Tamb Sensor Err	Error on air sensor, S2	
E32 / ---Tdis Sensor Err	Error on discharge sensor, S3	
E33 / ---Tsuc Sensor Err	Error on suction gas sensor, S4	
E39/--- Ps Sensor Err	Error on pressure transmitter Ps	

Data communication

The importance of individual alarms can be defined with a setting. The setting must be carried out in the group "Alarm destinations"

Settings from System manager	Settings from AKM (AKM destination)	Log	Alarm relay			Send via Network
			Non	High	Low-High	
High	1	X		X	X	X
Middle	2	X			X	X
Low	3	X			X	X
Log only		X				
Disabled						

Operation

Display

The values will be shown with three digits, and with a setting you can determine whether the temperature is to be shown in °C or in °F.

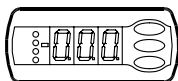

Light-emitting diodes (LED) on front panel

The LED's on the front panel will light up when the relevant relay is activated.

= Refrigeration

= heating element in crankcase is on

= Fan running

The light-emitting diodes will flash when there is an alarm. In this situation you can download the error code to the display and cancel/sign for the alarm by giving the upper button a brief push.

The buttons

When you want to change a setting, the upper and the lower button will give you a higher or lower value depending on the button you are pushing. But before you change the value, you must have access to the menu. You obtain this by pushing the upper button for a couple of seconds - you will then enter the column with parameter codes. Find the parameter code you want to change and push the middle buttons until value for the parameter is shown. When you have changed the value, save the new value by once more pushing the middle button. (If not operated for 20 (5) seconds, the display will change back to the Ts/Tc temperature display).

Examples

Set menu

1. Push the upper button until a parameter r05 is shown
2. Push the upper or the lower button and find that parameter you want to change
3. Push the middle button until the parameter value is shown
4. Push the upper or the lower button and select the new value
5. Push the middle button again to freeze the value.

Cutout alarm relay / receipt alarm/see alarm code

- A short press of the upper button
If there are several alarm codes they are found in a rolling stack. Push the uppermost or lowermost button to scan the rolling stack.

Set point

1. Push the middle button until the temperature value is shown
2. Push the upper or the lower button and select the new value
3. Push the middle button again to conclude the setting.

Reading the temperature at Ts (if Tc is the primary display) or Tc (if Ts is the primary display)

- A short press of the lower button

Get a good start

With the following procedure you can start regulation very quickly:

- 1 Open parameter r12 and stop the regulation (in a new and not previously set unit, r12 will already be set to 0 which means stopped regulation.
- 2 Select refrigerant via parameter o30
- 3 Open parameter r12 and start the regulation. Start/stop at input DI1 or DI2 must also be activated.
- 4 Go through the survey of factory settings. Make any necessary changes in the respective parameters.
- 5 For network.
 - Set the address in o03
 - Activate scan function in the system manager.

Note

When delivering the condensing unit, the controller will be set to the condensing unit type (setting o61). This setting will be compared with your refrigerant setting. If you select a "non-permitted refrigerant", the display will show "ref" and await a new setting.

(In the event of a controller change, 061 must be set as indicated in the instructions from Danfoss)

Menu survey

SW = 3.7x

Parameter		Code	Min. value	Max. value	Factory setting	Actual setting
Function						
Normal operation						
Set point (regulation reference follows the number of degrees above the outside temperature Tamb)		---	2.0 K	20.0 K	8.0 K	
Regulation						
Select SI or US display. 0=SI (bar and °C). 1=US (Psig and °F)		r05	0/°C	1/F	0/°C	
Internal Main Switch. Manual and service = -1, Stop regulation = 0, Start regulation = 1		r12	-1	1	0	
Offset during night operation. During night operation the reference is raised by this value		r13	0 K	10 K	2 K	
Set point for suction pressure Ts (only for Optyma™ Plus inverter)		r23	-30 °C	10 °C	-7 °C	
Readout of reference for Tc		r29				-
Thermostat cut-in value for an external heating element (o69=2 and o40=1)		r71	-30,0 °C	30,0 °C	-25 °C	
Min. condensing temperature (lowest permitted Tc reference)		r82	0 °C	40 °C	25 °C	
Max. condensing temperature (highest permitted Tc reference)		r83	20 °C	50 °C	40 °C	
Max. discharge gas temperature Td		r84	50 °C	140 °C	125 °C	
Alarms						
Alarm time delay on signal on the DI2 input. Active only if o37=4 or 5.		A28	0 min.	240 min.	30 min.	
Alarm for insufficient cooling in condenser. Temperature difference 30.0 K = Alarm disabled		A70	3.0 K	30.0 K	10.0 K	
Delay time for A80 alarm. See also parameter A70.		A71	5 min.	240 min.	30 min.	
Compressor						
Min. ON-time		c01	1 s	240 s	5 s	
Min. OFF-time		c02	3 s	240 s	120 s	
Min. time between compressor starts		c07	0 min.	30 min.	5 min.	
Pump down limit at which the compressor is stopped (setting 0.0 = no function)	***	c33	0,0 bar	6,0 bar	0,0 bar	
Min. compressor speed		c46	25 Hz	70 Hz	30 Hz	
Start speed for compressor		c47	30 Hz	70 Hz	50 Hz	
Max. compressor speed		c48	50 Hz	100 Hz	100 Hz	
Max. compressor speed during night operation (%-value of c48)		c69	50%	100%	70%	
Definition of compressor control mode 0: No compressor - Condensing unit OFF 1: Fixed speed - Input DI1 used to start / stop of fixed speed compressor 2: Variable speed - Input DI1 used for start / stop of variable speed-controlled compressor with a 0 – 10 V signal on AO2	*	c71	0	2	1	
Time delay for high Td. The compressor will stop when time expires.		c72	0 min.	20 min.	1 min.	
Max. pressure. Compressor stops if a higher pressure is recorded	***	c73	7,0 bar	31,0 bar	23,0 bar	
Difference for max. pressure (c73)		c74	1,0 bar	10,0 bar	3,0 bar	
Min. suction pressure Ps. Compressor stops if a lower pressure is recorded	***	c75	-0,3 bar	6,0 bar	1,4 bar	
Difference for min. suction pressure and pump down		c76	0,1 bar	5,0 bar	0,7 bar	
Amplification factor Kp for compressors PI-regulation		c82	3,0	30,0	20,0	
Integration time Tn for compressors PI-regulation		c83	30 s	360 s	60 s	
Liquid Injection Offset		c88	0,1 K	20,0 K	5,0 K	
Liquid Injection hysteresis		c89	3,0 K	30,0 K	15,0 K	
Compressor stop delay after Liquid injection		c90	0 s	10 s	3 s	
Desired compressor speed if the signal from the pressure transmitter Ps fails		c93	25 Hz	70 Hz	60 Hz	
Min On time during Low Ambient LP		c94	0 s	120 s	0 s	
Measured Tc for which the Comp min speed is raised to StartSpeed		c95	10,0 °C	70,0 °C	50,0 °C	
Control parameters						
Amplification factor Kp for PI-regulation		n04	1.0	20.0	7.0	
Integration time Tn for PI-regulation		n05	20	120	40	
Kp max for PI regulation when the measurement is far from reference		n95	5,0	50,0	20,0	
Fan						
Readout of fan speed in %		F07	-	-	-	
Permitted change in fan speed (to a lower value) % per second.		F14	1,0%	5,0%	5,0%	
Jog speed (speed as a % when the fan is started)		F15	40%	100%	40%	

continued		Code	Min.	Max.	Fac.	Actual
Jog speed at low temperature		F16	0%	40%	10%	
Definition of fan control: 0=Off; 1=Internal control (AC Fan); 2=External speed control (EC Fan)		F17	0	2	1	
Minimum fan speed. Decreased need will stop the fan.		F18	0%	40%	10%	
Maximum fan speed		F19	40%	100%	100%	
Manual control of the fan's speed. (Only when r12 is set to -1)	**	F20	0%	100%	0%	
Phase compensation (should only be changed by specially trained personnel.)		F21	0	50	20	
Pre-Ventilation time on A2L-refrigerants before compressor start		F23	30	180	30	
Real time clock						
Time at which they switch to day operation		t17	0 hrs	23 hrs	0	
Time at which they switch to night operation		t18	0 hrs	23 hrs	0	
Clock - Setting of hours		t07	0 hrs	23 hrs	0	
Clock - Setting of minute		t08	0 min.	59 min.	0	
Clock - Setting of date		t45	1 day	31 days	1	
Clock - Setting of month		t46	1 mon.	12 mon.	1	
Clock - Setting of year		t47	0 year	99 years	0	
Miscellaneous						
Network address		o03	0	240	0	
On/Off switch (Service Pin message) IMPORTANT! o61 must be set prior to o04 (used at LON 485 only)		o04	0/Off	1/On	0/Off	
Access code (access to all settings)		o05	0	100	0	
Readout of controllers software version		o08				
Select signal for display view. 1=Suction pressure in degrees, Ts. 2=Condensing pressure in degrees, Ts		o17	1	2	1	
Pressure transmitter working range Ps - min. value		o20	-1 bar	5 bar	-1	
Pressure transmitter working range Ps- max. value		o21	6 bar	200 bar	12	
Refrigerant setting: 2=R22. 3=R134a. 13=User defined. 17=R507. 19=R404A. 20=R407C. 21=R407A. 36=R513A. 37=R407F. 40=R448A. 41=R449A. 42=R452A. 39=R1234yf. 51=R454C. 52=R455A	*	o30	0	42	0	
Input signal on DI2. Function: (0=not used, 1=External safety function. Regulate when closed, 2=external main switch, 3=Night operation when closed, 4=alarm function when closed, 5=alarm function when open. 6=on/off Status for monitoring. 7=Alarm from speed regulation		o37	0	7	0	
Aux relay function: (0=not used, 1=External heating element, 2=liquid injection, 3=oil return function)	***	o40	0	3	1	
Pressure transmitter working range Pc - min. value		o47	-1 bar	5 bar	0 bar	
Pressure transmitter working range Pc - max. value		o48	6 bar	200 bar	32 bar	
Setting of condensing unit type (is factory set when the controller is mounted and cannot be subsequently changed)	*	o61	0	77	0	
The sensor input S3 is to be used to measure the discharge gas temperature (1=yes)		o63	0	1	1	
Replace the controllers factory settings with the present settings		o67	Off (0)	On (1)	Off (0)	
Defines the use of the Taux sensor: 0=not used; 1=measuring of oil temperature; 2=measurement from external heat function 3=other optional use		o69	0	3	0	
Period time for heating element in crankcase (ON + OFF period)		P45	30 s	255 s	240 s	
Difference for heating elements 100% ON point		P46	-20 K	-5 K	-10 K	
Difference for heating elements 100% OFF point		P47	5 K	20 K	10 K	
Read-out of operating time for condenser unit. (Value must be multiplied by 1,000). The value can be adjusted.		P48	-	-	0 h	
Read-out of compressor operating time. (Value must be multiplied by 1,000). The value can be adjusted.		P49	-	-	0 h	
Read-out of operating time of heating element in crankcase. (Value must be multiplied by 1,000). The value can be adjusted.		P50	-	-	0 h	
Read-out of number of HP alarms. The value can be adjusted.		P51	-	-	0	
Read-out of number of LP alarms. The value can be adjusted.		P52	-	-	0	
Read-out of number of Td alarms. The value can be adjusted.		P53	-	-	0	
Read-out of number of blocked condenser alarms. The value can be adjusted		P90	-	-	0	
Oil return management. Compressor speed for the counter starting point		P77	25 Hz	70 Hz	40 Hz	

continued		Code	Min.	Max.	Fac.	Actual
Oil return management. Limit value for counter		P78	5 min.	720 min.	20 min.	
Oil return management. Boost-speed		P79	40 Hz	100 Hz	50 Hz	
Oil return management. Boost-time.		P80	10 s	600 s	60 s	
Service						
Readout pressure on Pc		u01	bar			
Readout temperature Taux		u03	°C			
Status on DI1 input. 1=on=closed		u10				
Status on night operation (on or off) 1=on=night operation		u13				
Readout superheat		u21	K			
Readout temperature at S6 sensor		u36	°C			
Status on DI2 input. 1=on=closed		u37				
Readout the compressor capacity in %		u52	%			
Status on relay to compressor. 1=on=closed	**	u58				
Status on relay to fan. 1=on=closed	**	u59				
Status on relay to alarm. 1=on=closed	**	u62				
Status on relay "Aux". 1=on=closed	**	u63				
Status on relay to heating element in crank case. 1=on=closed	**	u71				
Status on high voltage input DI3. 1=on=230 V		u87				
Readout condensing pressure in temperature		U22	°C			
Readout pressure Ps		U23	bar			
Readout suction pressure in temperature		U24	°C			
Readout ambient temperature Tamb		U25	°C			
Readout discharge temperature Td		U26	°C			
Readout suction gas temperature Ts		U27	°C			
Readout the voltage on the output AO1		U44	V			
Readout the voltage on the output AO2		U56	V			

*) Can only be set when regulation is stopped (r12=0)

**) Can be controlled manually, but only when r12=-1

***) This parameter depends on parameter o30 and o61 settings

Factory setting

If you need to return to the factory-set values, it can be done in this way:

- Cut out the supply voltage to the controller
- Keep upper and lower button depressed at the same time as you reconnect the supply voltage

Reset of unit statistics parameters

All the Unit status parameters (P48 to P53 and P90) can be set / cleared using the following procedure

- Set Main Switch to 0
- Change the Statistics parameters - like setting Alarm counters to 0
- Wait 10 seconds - to ensure write to EEROM
- Make a repower of the Controller - transfer new settings to "statistics function"
- Set Main Switch ON - and the parameters is set to the new value

Connections

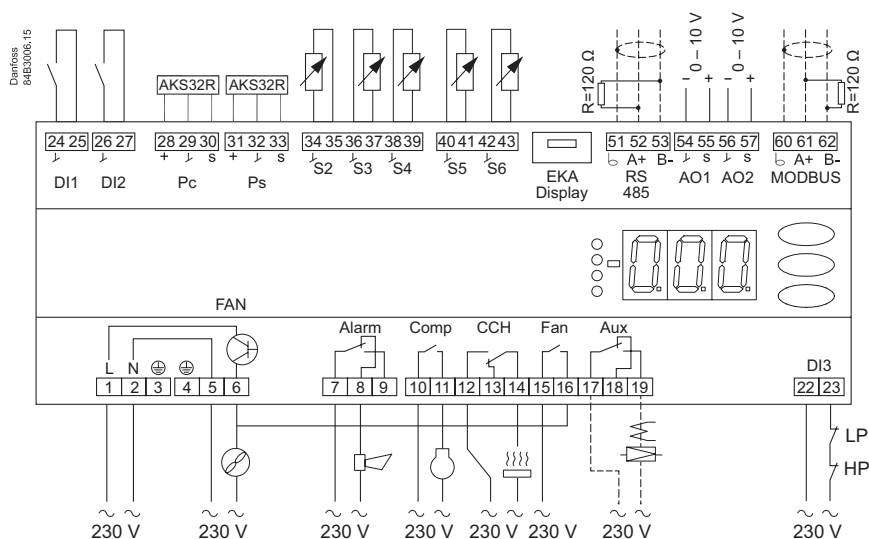

DI1

Digital input signal.
Used to start/stop cooling (room thermostat)
Starts when the input is short-circuited.

DI2

Digital input signal.
The defined function is active when the input is short-circuited/
opened. The function is defined in o37.

Pc

Pressure transmitter, ratiometric AKS 32R, 0 to 32 bar
Connect to terminal 28, 29 and 30.

Ps

Pressure transmitter, ratiometric e.g. AKS 32R, -1 to 12 bar
Connected to terminal 31, 32 and 33.

S2

Air sensor, Tamb. Pt 1000 ohm sensor, eg. AKS 11

S3

Discharge gas sensor, Td. Pt 1000 ohm sensor, eg. AKS 21

S4

Suction gas temperature, Ts. Pt 1000 ohm sensor, eg. AKS 11

S5,

Extra temperature measurement, Taux. Pt 1000 ohm sensor, eg. AKS 11

S6,

Extra temperature measurement, S6. Pt 1000 ohm sensor, eg. AKS 11

EKA Display

If there is be external reading/operation of the controller, display type EKA 163B or EKA 164B can be connected.

RS485 (terminal 51, 52,53)

For data communication, but only if a data communication module is inserted in the controller. The module can be Lon.
If data communication is used, it is important that the installation of the data communication cable is performed correctly.
See separate literature No. RC8AC...

AO1, terminal 54, 55

Output signal, 0 – 10 V. Must be used if the fan is equipped with internal speed control and 0 – 10 V DC input, e.g. EC-motor.

AO2, terminal 56, 57

Output signal, 0 – 10 V. Must be used if the compressor is speed controlled.

MODBUS (terminal 60, 61, 62)

Built in Modbus data communication.
If data communication is used, it is important that the installation of the data communication cable is performed correctly.
See separate literature No. RC8AC...
(Alternatively the terminals can be connected to an external display type EKA 163A or 164A, but then they cannot be used for data communication. Any data communication must then be carried out by one of the other methods.)

Supply voltage

230 V AC (This must be the same phase for all 230 V connections).

FAN

Fan connection. Speed controlled internally.

Alarm

There is a connection between terminal 7 and 8 in alarm situations and when the controller is without power.

Comp

Compressor. There is a connection between terminal 10 and 11, when the compressor is running.

CCH

Heating element in the crankcase
There is connection between terminals 12 and 14 when heating takes place.

Fan

There is connection between terminals 15 and 16 when the fan's speed is raised to over 95%. (Fan signal changes from terminal 5-6 to 15-16. Connect wire from terminal 16 to the fan.)

Aux

Liquid injection in suction line / external heating element / oil return function for speed-controlled compressor
 There is connection between terminals 17 and 19, when the function is active.

DI3

Digital input signal from low/high pressure monitoring.
 The signal must have a voltage of 0 / 230 V AC.

Electric noise

Cables for sensors, DI inputs and data communication **must** be kept separate from other electric cables:

- Use separate cable trays
- Keep a distance between cables of at least 10 cm.
- Long cables at the DI input should be avoided

Installation considerations

Accidental damage, poor installation, or site conditions, can give rise to malfunctions of the control system, and ultimately lead to a plant breakdown. Every possible safeguard is incorporated into our products to prevent this. However, a wrong installation, for example, could still present problems. Electronic controls are no substitute for normal, good engineering practice.

Danfoss will not be responsible for any goods, or plant components, damaged as a result of the above defects. It is the installer's responsibility to check the installation thoroughly, and to fit the necessary safety devices. Special reference is made to the necessity of signals to the controller when the compressor is stopped and to the need of liquid receivers before the compressors. Your local Danfoss agent will be pleased to assist with further advice, etc.





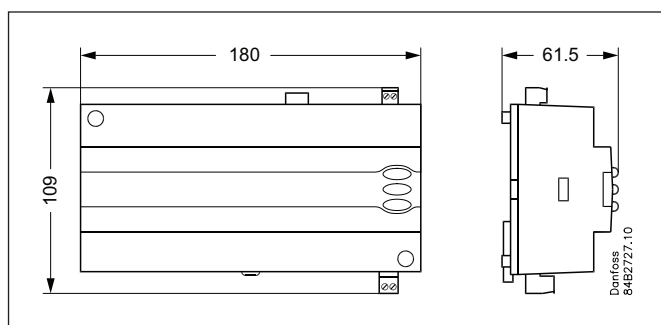

Data

Supply voltage	230 V AC +10/-15 %. 5 VA, 50 / 60 Hz	
Sensor S2, S3, S4, S5, S6	Pt 1000	
Accuracy	Measuring range	-60 – 120 °C (S3 to 150 °C)
	Controller	±1 K below -35°C ± 0.5 K between -35 – 25 °C; ±1 K above 25 °C
	Pt 1000 sensor	±0.3 K at 0 °C ±0.005 K per degree
Measuring of Pc, Ps	Pressure transmitter	Ratiometric. eg. AKS 32R, DST-P110
Display	LED, 3-digits	
External display	EKA 163B or 164B (any EKA 163A or 164A)	
Digital inputs DI1, DI2	Signal from contact functions Requirements to contacts: Gold plating Cable length must be max. 15 m Use auxiliary relays when the cable is longer	
Digital input DI3	230 V AC from safety pressostat. Low/high pressure	
Electrical connection cable	Max.1.5 mm ² multi-core cable	
Triac output	Fan	Max. 240 V AC, Min. 28 V AC Max. 2.0 A Leak < 1 mA
		CE (250 V AC)
Relays*	Comp, CCH	4 (3) A
	Alarm, Fan, Aux	4 (3) A
Analog output	2 pcs. 0 – 10 V DC (For external speed control of fans and compressors) Min. load = 10 K ohm. (Max. 1 mA)	
Environments	-25 – 55 °C, During operations	
	-40 – 70 °C, During transport	
	20 - 80% Rh, not condensed No shock influence / vibrations	
Density	IP 20	
Mounting	DIN-rail or wall	
Weight	0.4 kg	
Data communication	Fixed	MODBUS
	Extension options	LON
Power reserve for the clock	4 hours	
Approvals	EC Low Voltage Directive and EMC demands re CE-marking complied with LVD tested acc. EN 60730-1 and EN 60730-2-9, A1, A2 EMC-tested acc. EN 61000-6-2 and EN 61000-6-3	

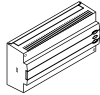
* Comp and CCH are 16 A relays. Alarm and Fan are 8 A relays. Max. load must be observed

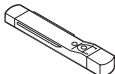

Ordering

Type		Function	Code no.
Optyma™ Plus		Condensing unit controller Prepared for data communication Plug for screw terminals not enclosed	084B8080
Plug		Plug with screw terminals	084B8166
EKA 175		Data communication module LON RS485	084B8579
EKA 163B		External display with plug for direct connection	084B8574
EKA 164B		External display with operation buttons and plug for direct connections	084B8575
EKA 163A		External display with screw terminals	084B8562
EKA 164A		External display with operation buttons and screw terminals	084B8563
Wire with plug		Wire for display unit (9 m, with plug)	084B7630 (24 pcs.)
EKA 183A		Programming key	084B8582

Danfoss A/S

Climate Solutions • danfoss.com • +45 7488 2222

Any information, including, but not limited to information on selection of product, its application or use, product design, weight, dimensions, capacity or any other technical data in product manuals, catalogues descriptions, advertisements, etc. and whether made available in writing, orally, electronically, online or via download, shall be considered informative, and is only binding if and to the extent, explicit reference is made in a quotation or order confirmation. Danfoss cannot accept any responsibility for possible errors in catalogues, brochures, videos and other material. Danfoss reserves the right to alter its products without notice. This also applies to products ordered but not delivered provided that such alterations can be made without changes to form, fit or function of the product.

All trademarks in this material are property of Danfoss A/S or Danfoss group companies. Danfoss and the Danfoss logo are trademarks of Danfoss A/S. All rights reserved.