

User Guide

Danfoss Gas Sensor Type **DGS**



Contents

1. Intended use	3
2. Introduction	3
3. Installation and maintenance	3
3.1 Technician use only!	3
3.2 Regular Test	3
3.3 Location	3
3.4 Dimensions and appearance	4
3.5 Cable gland opening	4
3.6 Board pinout	4
3.7 Installation instructions	6
3.8 Installation Test	7
3.9 Troubleshooting	8
3.10 Power Conditions and Shielding Conceptions	8
4. Operation	10
4.1 Function of the keys and LEDs on the keypad	11
4.2 Setting / changing of parameters and set points	11
4.3 Code levels	11
5. Menu overview	12
5.1 Error status	13
5.2 Alarm Status	14
5.3 Relay Status	14
5.4 Menu Measuring Values	14
5.5 Display Parameters	15
5.5.1 Software Version	15
5.5.2 Language	15
5.5.3 LCD Function Check	15
5.6 Alarm Reset Settings	15
5.6.1 Relay Reset	15
5.6.2 Alarm reset duration	16
5.7 Alarm Settings	16
5.7.1 Room mode	16
5.7.2 Alarm limits	16
5.7.3 Alarm relay	16
5.8 AO Settings	17
5.9 Operating Data	18
5.10 Calibration	19
5.10.1 Zero calibration	20
5.10.2 Gain calibration	21
5.10.3 Zero point calibration of analogue output	22
5.11 Addressing	22
6. MODBUS menu survey	23
7. Ordering	25

1. Intended use This document has the intent to provide the guidelines to avoid possible damages deriving from overvoltage and other possible issues resulting from the connection to the DGS power supply and the serial communication network. Moreover it provides the operations executed via handheld Service Tool. The display of the hand-held Service Tool and the MODBUS interface for integration with Building Management Systems is used as interface for operation, commissioning and calibration of the DGS gas detection unit.

2. Introduction For what concerns display devices, this user guide contains the maximum possible functionality. Depending on the DGS type some features described here are not applicable and therefore the menu items may be hidden. Some special features are available via the hand-held Service Tool interface only (not via MODBUS). This includes the calibration routine and certain properties of the sensor head.

3. Installation and maintenance

3.1 Technician use only! This unit must be installed by a suitably qualified technician who will install this unit in accordance with these instructions and the standards set down in their particular industry/country. Failure to install and operate the unit in accordance with these instructions and with industry guidelines may cause serious injury including death, and the manufacturer will not be held responsible in this regard. Suitably qualified operators of the unit should be aware of the regulations and standards set down by their industry/country for the operation of this unit. It is the installer's responsibility to adequately ensure that the equipment is installed correctly and set up according to the environment and the application in which the products are being used. These notes are only intended as a guide, and the manufacturer bears no responsibility for the installation or operation of this unit.

Please observe that DGS works as a safety device securing a reaction to a detected high gas concentration. If a leakage occurs, the DGS will provide alarm functions, but it will not solve or take care of the leakage root cause itself.

3.2 Regular Test To maintain product performance and comply with the local requirements, the DGS must be tested regularly. DGSs are provided with a test button that may be activated to validate the alarm reactions. Additionally, the sensors must be tested by either bump test or calibration. Danfoss recommends the following minimum calibration intervals:
DGS-IR: 60 months
DGS-SC: 12 months
DGS-PE: 6 months

With DGS-IR it is recommended to do an annual bump test in years without calibration. Check local regulations on calibration or testing requirements. For propane: after exposure to a substantial gas leak, the sensor should be checked by bump test or calibration and replaced if necessary.

3.3 Location For all gases heavier than air, Danfoss recommends placing the sensor head app. 30 cm (12") above the floor and, if possible, in the air flow. All gases measured with these DGS sensors are heavier than air: HFC grp 1, HFC grp 2, HFC grp 3, CO₂ and propane. For further details on Test and Location please see the Danfoss Application Guide: "Gas detection in refrigeration systems".

3.4 Dimensions and appearance

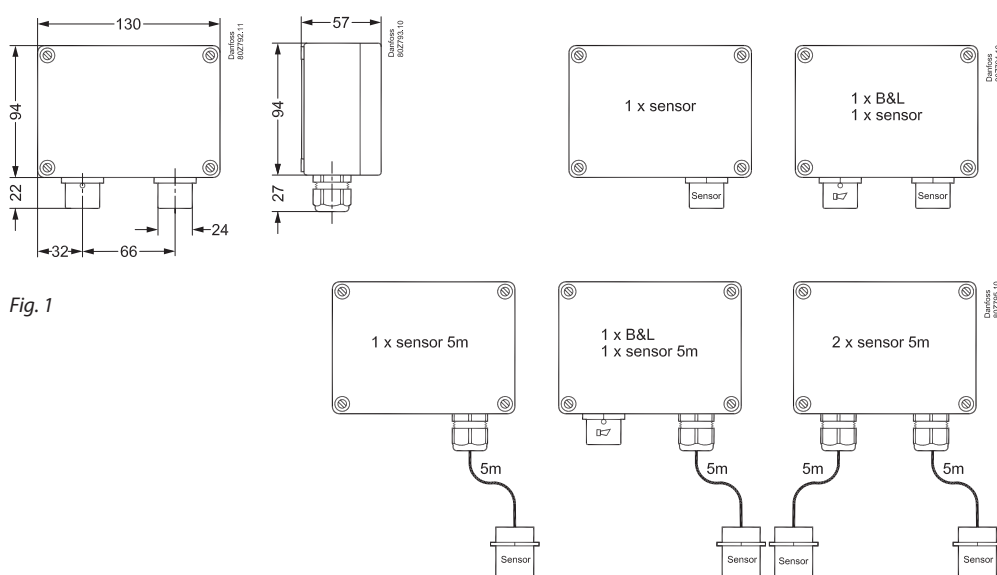
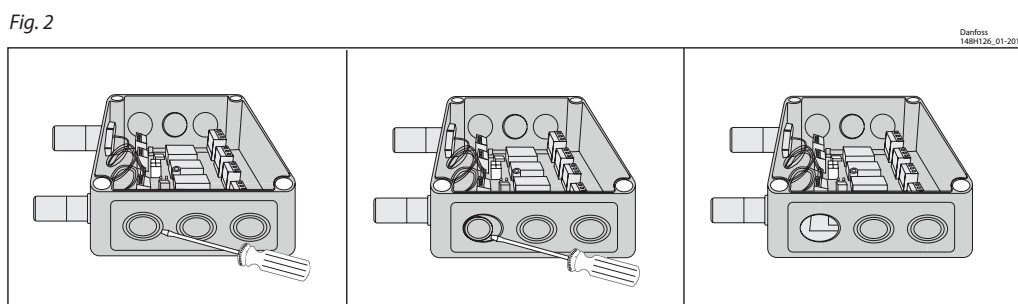

Fig. 1

3.5 Cable gland opening



- Hole punching for cable gland:
1. Select the location for the safest cable entry
 2. Use a sharp screwdriver and a small hammer
 3. Place the screwdriver and hammer with precision while moving the screwdriver within a small area until the plastic is penetrated.

Continue precision punching with small movements until the round piece can be pulled out with your fingers.

Remove potential burrs and secure flat surfaces.
Install the cable gland according to the enclosed guide.

WARNING: be very careful not to damage the internal board components with the screwdriver.

3.6 Board pinout

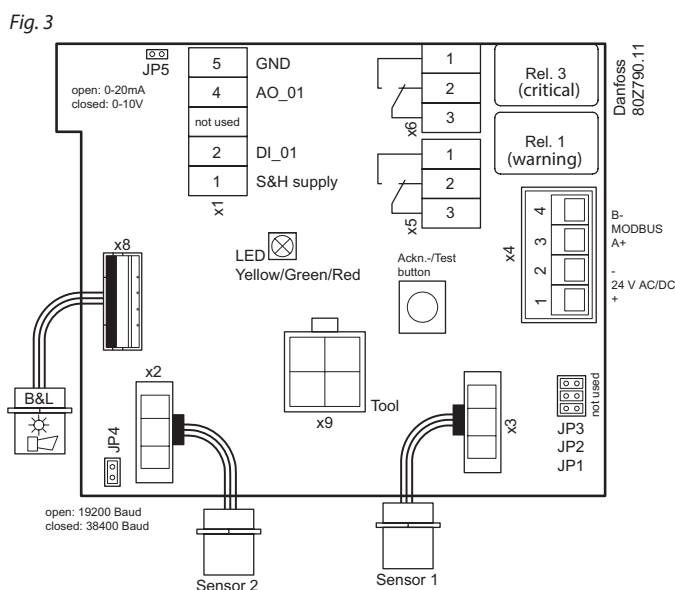

Note: For what concern the power supply, please refer to chapter 3.10 *Power Conditions and Shielding Conceptions*.
A Class II power supply is recommended

Status LED / B&L:

GREEN is power on.

- flashing if maintenance needed

YELLOW is an indicator of Error.

- the sensor head is disconnected or not the expected type
- AO configured as 0 – 20 mA, but no current is running
- flashing when sensor is in special mode (e.g. when changing parameters with the Service Tool)
- Supply voltage out of range

RED flashing: is an indication of alarm due to gas concentration level. The Buzzer & Light behaves identical to the status LED.

Ackn. / Test button / DI_01:

TEST: The button must be pressed for 8 sec.

- Critical and warning alarm is simulated and AO goes to max. (10 V/20 mA), stops on release.

ACKN: If pressed during critical alarm, as default* the relays and Buzzer go out of alarm condition and back on after 5 minutes if the alarm situation is still active.

* the duration and whether to include the relay status with this function or not is user defined. DI_01 (terminals 1 and 2) is a dry-contact (potential-free) behaving identically to the Ackn./Test button.

DC supply for external Strobe & Horn

Whether the DGS is powered by 24 V DC or 24 V AC, a 24 V DC power supply (max. 50 mA) is available between terminals 1 and 5 on connector x1.

Jumpers

* JP4 open → 19200 Baud
JP4 closed → 38400 Baud (default)

* JP5 open → AO 0 – 20 mA
JP5 closed → AO 0 – 10 V (default)

Note: the DGS must be power cycled before any change to JP4 takes effect.

Analog Output:

If the analog output AO_01 is used (terminals 4 and 5) then you need the same ground potential for the AO and the connected device.

Note: JP1, JP2 and JP3 are not used.

3.7 Installation instructions

The DGS is available with one or two sensors and B&L (Buzzer and Light) as option (see fig. 1). For sensors that can be poisoned by e.g. silicones like all semiconductor and catalytic bead sensors, it is imperative to only remove the protective cap *after* all silicones are dry, and then energize the device.

The sensor protection cap must be removed before taking the DGS into operation

Mounting and wiring

To wall mount the DGS, unscrew the lid by releasing the four plastic screws in each corner and remove the lid. Mount the DGS base to the wall by fitting screws through the holes which the lid screws were fastened by. Complete the mounting by re-applying the lid and fastening the screws.

The sensor head must always be mounted so that it points downwards. The DGS-IR sensor head is sensitive to shock – special attention should be paid to **protect the sensor head from shocks** during installation and operation.

Observe the recommended placing of the sensor head as stated on page 1.

Extra cable glands are added by following the instruction in fig. 2.

The exact position of the terminals for the sensors, alarm relays, digital input and analogue output is shown in the connection diagrams (see fig. 3).

The technical requirements and regulations for wiring, electrical security, as well as project specific and environmental requirements and regulations must be met.

Configuration

For convenient commissioning, the DGS is pre-configured and parameterized with factory-set defaults. See Menu Survey on page 5.

Site of Installation

When choosing the mounting location, you have to consider the ambient conditions in order to get representative measurement results. Please pay special attention to the following factors:

- External heat sources are not allowed on the installation site.
- Choose mounting location according to the local regulations.
- Consider ventilation conditions! Do not mount next to air passages or suction holes.
- The sample gas must pass the sensor even under adverse flow conditions. A flow test can be performed for instance with smoke tubes.
- Use a wind shield if the flow conditions are > 6 m/s.
- Mount the device at a location with minimum vibration and minimum variation in temperature (no direct sunlight).
- Avoid locations where water, oil etc. may influence proper operation and where mechanical damage might be possible.

Jumpers are used to change the analogue output type and the MODBUS baud rate. See fig. 3. For DGS with Buzzer & Light, alarm actions are given according to following table below.

System integration

To integrate the DGS with a Danfoss system manager or general BMS system, set the MODBUS address using the DGS Service Tool, using password "1234" when prompted. See the DGS User Guide for details on operating the DGS Service Tool.

The Baud Rate is adjusted by jumper JP4. As default, the setting is 38.4k Baud. For integration with AK-SM 720/350 change the setting to 19.2k Baud.

For more information about data communication see Danfoss document RC8AC--

Sensor replacement

The sensor is connected to the DGS via a plug connection enabling simple sensor exchange instead of an on-site calibration.

The internal replacement routine recognizes the exchanging process and the exchanged sensor and re-starts the measurement mode automatically.

The internal replacement routine also examines the sensor for actual type of gas and actual measuring range. If the data does not match the existing configuration, the built-in status LED indicates an error. If everything is OK the LED will light up green.

As an alternative, the on-site calibration via the DGS Service Tool can be performed with the integrated, user friendly calibration routine.

See the DGS User Guide for details on operating the DGS Service Tool.

- Provide adequate space around the sensor for maintenance and calibration work.
- It is mandatory to comply with the legal requirements for the installation of gas detectors.
- The optimum mounting location may vary depending on the area of application.
- The recommended mounting height depends on the relative gas density of the type of gas to be monitored.

Depending on the relative gas density (d), the following recommendation applies:

$d \leq 0.85$	Mount 0.3–0.5 m below the ceiling
$0.85 < d < 1.15$	Mount at a height of 1.2–1.8 m above floor
$d \geq 1.15$	Mount at a height of 0.3–0.5 m above floor

Action	Reaction Buzzer	Reaction Light	Warning relay 1** SPDT NO (Normally Open)	Critical relay 3** SPDT NC (Normally closed)
Loss of power to DGS	OFF	OFF		X (closed)
Gas signal < warning alarm threshold	OFF	GREEN		
Gas signal > warning alarm threshold	OFF	RED Slow flashing	X (closed)	
Gas signal > critical alarm threshold	ON	RED Fast flashing	X (closed)	X (closed)
Gas signal ≥ critical alarm threshold, but ackn. button pressed	OFF (ON after delay)	RED Fast flashing	X (closed)*	(open)*
No alarm, no fault	OFF	GREEN		
No fault, but maintenance due	OFF	GREEN Slow flashing		
Sensor communication error	OFF	YELLOW		
DGS in special mode	OFF	YELLOW flashing		

Alarm thresholds can have the same value, therefore both the relays and the Buzzer and Light can be triggered simultaneously.

The alarm thresholds have a hysteresis of app. 5%

* whether to include the relay status with the acknowledge function or not is user defined.

** If the DGS has two sensors and the "Room Mode" is configured to "2 rooms", then relay 1 acts as a critical relay for sensor 1 and relay 3 acts as a critical relay for sensor 2. Both relays are SPDT NC. The Buzzer and Light operation is independent of the "Room Mode" setting.

3.8 Installation Test

As DGS is a digital device with self-monitoring, all internal errors are visible via the LED and MODBUS alarm messages. All other error sources often have their origins in other parts of the installation. For fast and comfortable installation test we recommend proceeding as follows.

Optical Check

Right cable type used.
Correct mounting height according to definition in the section about mounting.
LED status – see DGS trouble shooting.

Functional test (for initial operation and maintenance)

Functional test is done by pressing the test button for more than 8 seconds and observing that all connected outputs (Buzzer, LED, Relay connected devices) are working properly. After deactivation all outputs must automatically return to their initial position.

Zero-point test (if prescribed by local regulations)

Zero-point test with fresh outdoor air. A potential zero offset can be read out by use of the Service Tool.

Trip test with reference gas (if prescribed by local regulations)

The sensor is gassed with reference gas (for this you need a gas bottle with pressure regulator and a calibration adapter).

In doing so, the set alarm thresholds are exceeded, and all output functions are activated. It is necessary to check if the connected output functions are working correctly (e.g. the horn sounds, the fan switches on, devices shut down). By pressing the push-button on the horn, the horn acknowledgement must be checked. After removal of the reference gas, all outputs must automatically return to their initial position. Other than the trip testing, it is also possible to perform a functional test by means of calibration. For further information, please refer to the User Guide.

Comparing sensor gas type with DGS specification

The replacement sensor specification must match the DGS specification.

The DGS software automatically reads the specification of the connected sensor and compares with the DGS specification.

This feature increases the user and operating security.

New sensors are always delivered factory-calibrated by Danfoss. This is documented by the calibration label indicating date and calibration gas. A re-calibration is not necessary during commissioning if the device is still in its original packaging (including air-tight protection by the red protective cap) and if the calibration certificate has not expired

3.9 Troubleshooting

Symptom:	Possible cause(s):
LED off	<ul style="list-style-type: none"> • Check power supply. Check wiring. • DGS MODBUS was possibly damaged in transit. Check by installing another DGS to confirm the fault.
Green flashing	<ul style="list-style-type: none"> • The sensor calibration interval has been exceeded or the sensor has reached the end of life. Carry out calibration routine or replace with a new factory calibrated sensor.
Yellow	<ul style="list-style-type: none"> • AO configured but not connected (only 0 – 20 mA output). Check wiring. • Sensor type does not match DGS specification. Check gas type and measuring range. • Sensor may be disconnected from printed circuit board. Check to see if the sensor is properly connected. • The sensor has been damaged and needs to be exchanged. Order replacement sensor from Danfoss. • Supply voltage out of range. Check power supply.
Yellow flashing	<ul style="list-style-type: none"> • The DGS is set to service mode from the hand-held Service Tool. Change setting or await time-out within 15 minutes.
Alarms in the absence of a leak	<ul style="list-style-type: none"> • If you experience alarms in the absence of a leak, try setting an alarm delay. • Perform a bump test to ensure proper operation.
The zero-measurement drifts	<p>The DGS-SC sensor technology is sensitive to the environment (temperature, moist, cleaning agents, gases from trucks, etc). All ppm measurements below 75 ppm should be disregarded, i.e. no zero-adjustment made.</p>

3.10 Power Conditions and Shielding Conceptions

Standalone DGS without Modbus network communication

Shield/screen is not required for standalone DGS with no connection to a RS-485 communication line. However, it can be done as described in the next paragraph (Fig. 4).

DGS with Modbus network communication in combination with other devices powered by the same power supply

It is strongly recommended to use direct current power supply when:

- more than 5 DGS units are powered by the same power supply
- the bus cable length is longer than 50 m for those powered units

It is moreover recommended to use class 2 power supply (see [AK-PS 063](#))

Make sure to not interrupt the shield when connecting A and B to the DGS (see Fig. 4).

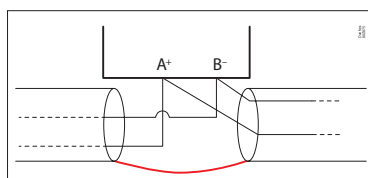

Fig. 4: Loop trough

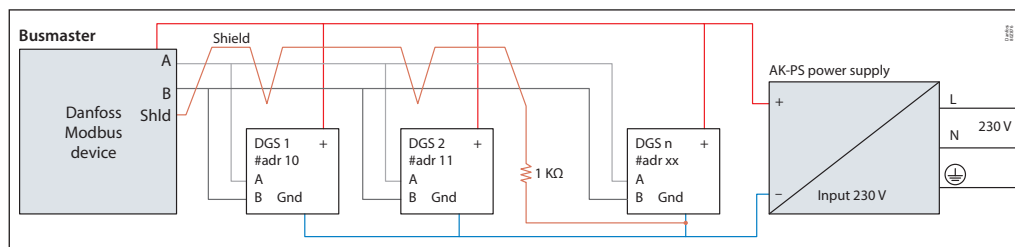

Fig. 5: Wiring diagram for system with one power supply

Ground potential difference between nodes of the RS485 network might affect the communication. It is advised to connect a 1 kΩ 5% ¼ W resistor between the shield and the ground (X4.2) of any unit or group of units connected to the same power supply (Fig. 5).

Please refer to Literature No. AP363940176099.

DGS with Modbus network communication in combination with other devices powered by more than one power supply

It is strongly recommended to use direct current power supply when:

- more than 5 DGS units are powered by the same power supply
- the bus cable length is longer than 50 m for those powered units

It is moreover recommended to use class 2 power supply (see [AK-PS 063](#))

Make sure to not interrupt the shield when connecting A and B to the DGS (see Fig. 4).

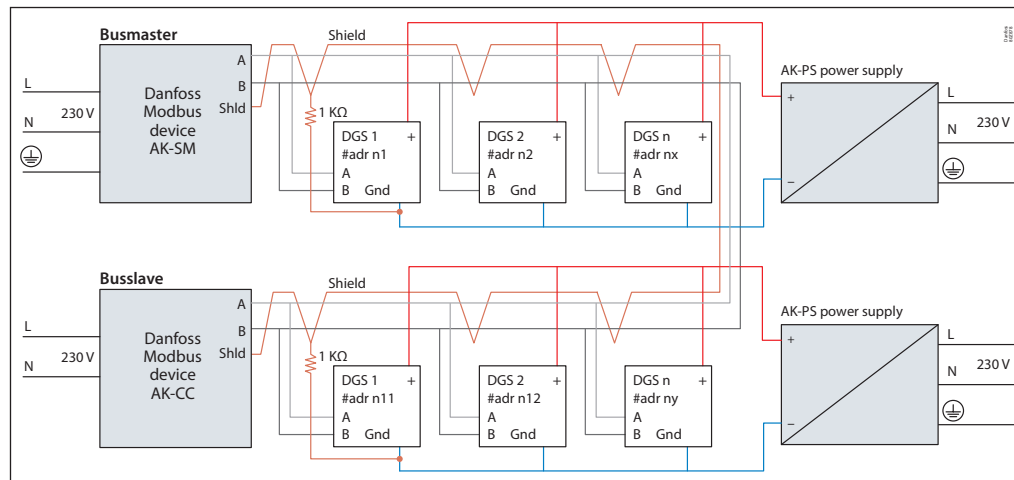

Fig. 6: Wiring diagram for system with multiple power supplies

Ground potential difference between nodes of the RS485 network might affect the communication. It is advised to connect a 1 KΩ 5% ¼ W resistor between the shield and the ground (X4.2) of any unit or group of units connected to the same power supply (Fig. 6).

Please refer to Literature No. AP363940176099.

Power supply and voltage alarm

The DGS device goes into voltage alarm when voltage exceeds certain limits.

The lower limit is 16 V.



The upper limit is 28 V, if DGS software version is lower than 1.2 or 33.3 V in all other cases.

When in the DGS the voltage alarm is active, in the System Manager the “Alarm inhibited” is raised.

4. Operation

The configuration and service is made via the hand-held Service Tool or in combination with the MODBUS interface.

Security is provided via password protection against unauthorized intervention.

<p>Hand-held Service Tool: Operation is done via 6 buttons.</p> 	<p>AK-System Manager: The configuration is done via the graphical display and buttons or via the PC tools StoreView Desktop or AK-ST 500.</p> 
--	--

Operation with the hand-held Service Tool is described in sections 4.1 – 4.3 and chapter 5. Operation with the Danfoss Front End is described in chapter 6.

Two functions are configured via jumpers on the DGS.





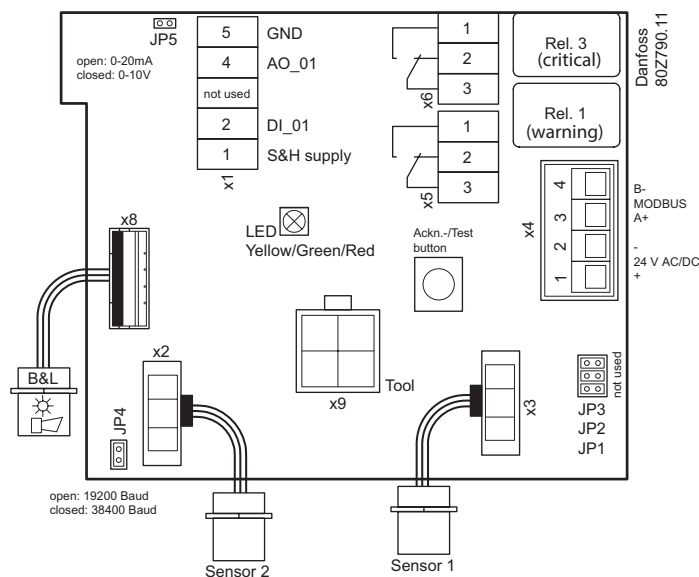

Jumper 4, JP 4, located at the bottom left, is used to configure the MODBUS baud rate. As default the baud rate is 38400 Baud. By removing the jumper, the baud rate is changed to 19200 Baud. Removing the jumper is required for integrating with Danfoss System Managers AK-SM 720 and AK-SM 350.

Jumper 5, JP5, located at the top left, is used to configure the analogue output type. As default this is voltage output. By removing the jumper, this is changed to current output.

Note: the DGS must be power cycled before any change to JP4 takes effect. JP1, JP2 and JP3 are not used.



4.1 Function of the keys and LEDs on the keypad







-  Exits programming, returns to the previous menu level.
-  Enters sub menus, and saves parameter settings.
-   Scrolls up & down within a menu, changes a value.
-   Change of cursor position.

The status LEDs indicate the operating status:

- **Green**
Continuous = operating voltage
- **Yellow**
Continuous = failure
Slowly flashing = warming-up
Fast flashing = special mode
- **Red**
Continuous = alarm

The backlight of the display changes from green to red when an alarm is active.

4.2 Setting / changing of parameters and set points

-  Open desired menu window.
Code input field opens automatically if no code is approved.
- After input of valid code, the cursor jumps to the first position segment to be changed.
-   Push the cursor to the position segment, which has to be changed.
 -   Set the desired parameter / set point with the keys.
 -  Save the changed value, confirm storage (ENTER).
 -  Cancel the save / close editing / return to a higher menu level (ESCAPE function).
-

4.3 Code levels

All inputs and changes are protected by a four-digit numeric code (= password) against unauthorised intervention according to the regulations of all national and international standards for gas warning systems. The menu windows of status messages and measuring values are visible without entering a code.

The access to the protected features is valid as long as the service tool remains connected.

The service technician's access code to the protected features is '1234'.

5. Menu overview

Menu operation is done via a clear, intuitive and logical menu structure. The operating menu contains the following levels:

- Starting menu with indication of the device type if no sensor head is registered, otherwise scrolling display of the gas concentrations of all registered sensors in 5-second intervals.
- Main menu
- 5 sub menus under “Installation and Calibration”

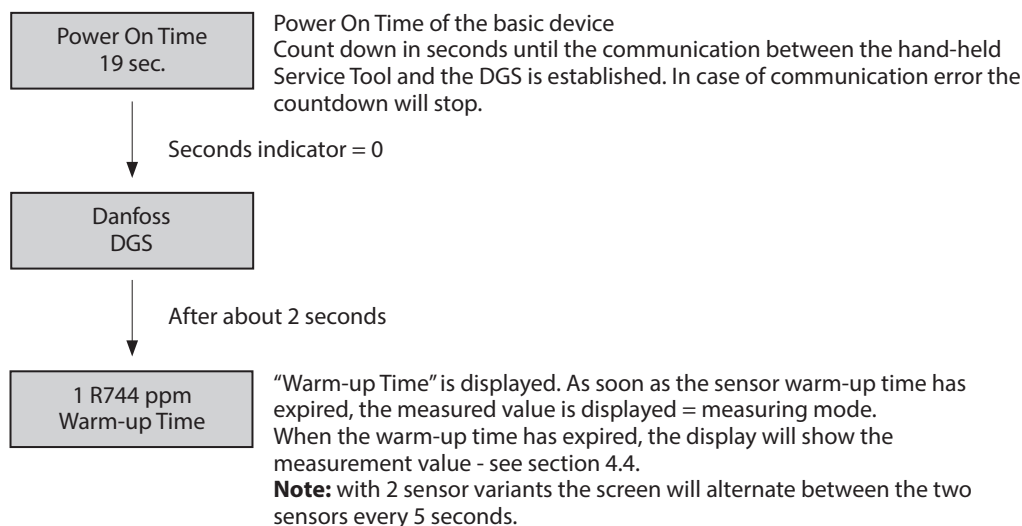

Start menu

Main menu

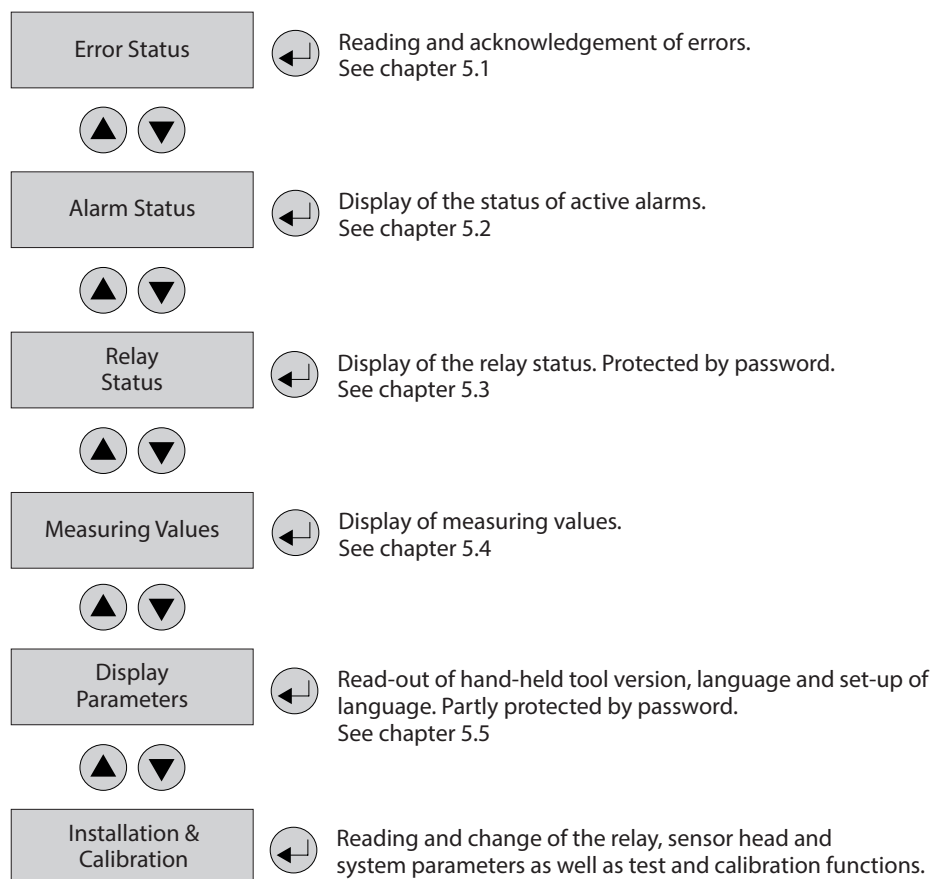

Menu overview
(continued)

Start menu

Main menu

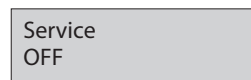

The following menu items are only accessible with Service ON (password protected)
!! Service ON = special mode = fault message is active!!

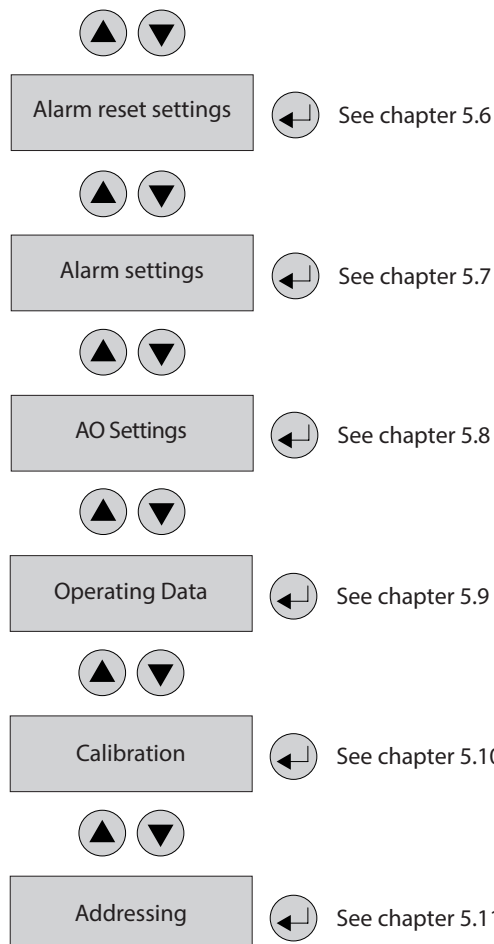

5.1 Error status

A pending fault activates the yellow LED (Fault). The first 50 pending errors are displayed in the menu "System Errors".

A number of error messages may be displayed related to the sensor: Out of Range, Wrong type, Removed, Calibration due, Voltage Error. "Voltage Error" refers to the supply voltage. In this case the product will not go into normal operation until the supply voltage is within the specified range.

5.2 Alarm Status

Display of the currently pending alarms in plain text in the order of their arrival. Only those sensor heads are displayed, where at least one alarm is active.

Alarms in latching mode (latching mode is only valid for certain DGS types, DGS-PE) can be acknowledged in this menu (only possible if the alarm is not active).

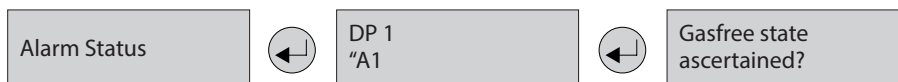

Symbol	Description	Function
DP 1	Sensor head No.	DP 1: Sensor 1 DP 2: Sensor 2 (2-sensor variant only)
'A1 'A1	Alarm status	' = Alarm active " = Alarm in latching mode, can be acknowledged 1 = Relays 1 = Warning relay 3 = Relay 3 = Critical relay

5.3 Relay Status

Reading of the current status of alarm relays.

The actual relay status is displayed, depending on the relay mode (energized <> de-energized).

Selection of alarm relay:

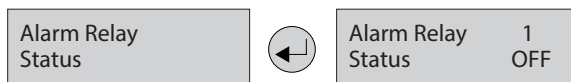

Selection of the next alarm relay

Symbol	Description	Function
1	Alarm Relay	1 = Relays 1 = Warning relay 2 = Buzzer 3 = Relay 3 = Critical relay
OFF	Relay Status	Relay OFF = coil de-energized
ON	Relay Status	Relay ON = coil energized

Note: Relay 3 is used for critical alarm indication. Relay 1 may be configured for critical alarm indication with the 2-sensor variant. A critical alarm relay has a Normally Closed contact set which indicates an alarm if the power to the DGS is lost. In the table above the relays status refers to energizing of the coil, which activates the contact set. Hence, for a critical relay in normal operation the coil is energized, causing the contact set to open and the relay status to read "ON". In the alarm condition, the coil is de-energized, causing the contact set to close and the relay status to read "OFF".

5.4 Menu Measuring Values

In this menu, the display shows the measuring value with gas type and unit.

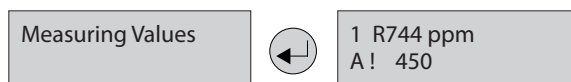

Selection of the next sensor head

Symbol	Description	Function
1	Actual MODBUS address	1: MODBUS address = 1
R744	Gas type	Display of gas type (must comply with gas type of sensor head)
ppm	Gas unit	Unit
51.0 °C	Measured value	Current value of the gas concentration
A!	Alarm indication	At least one alarm has been released at this sensor head
#	Maint. info	Sensor head: maintenance due (maintenance date exceeded)
?	ConfigError	Gas type or meas. range does not comply with sensor head
Comm. err.	Fault sensor head	Communication error, sensor head <> I/O board
Underrange Overrange	Meas. range monitoring	Meas. signal < admissible range (< zero point - 6 %) Meas. signal > admissible range (> full scale value + 6 %)
Warm-up	Warm-up time	Warm-up time of the sensor is active

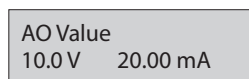

The actual analogue output value in voltage and milliampere.

5.5 Display Parameters

In the menu display parameters you can find the general parameters of the Service Tool and the DGS.

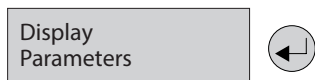

5.5.1 Software Version

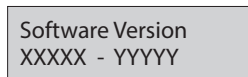

Software version of the hand-held Service Tool and of the DGS.

Symbol	Description	Function
XXXXX	Software Version of the Service Tool	XXXXX Software Version
YYYYY	Software Version of the DGS	YYYYY Software Version

5.5.2 Language

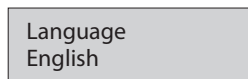

Selection of the menu language (password protected)

Symbol	Description	Default	Function
English	Language	English	English Spanish French Italian German

5.5.3 LCD Function Check

Function for testing the LCD function (password protected) All LEDs light up for about two seconds. The backlight is yellow. All points are displayed on the LCD.

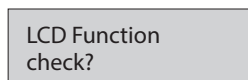

5.6 Alarm Reset Settings

This section describes how the DGS reacts when an active alarm is reset (acknowledged).

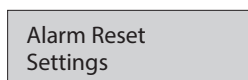

5.6.1 Relay Reset

This defines if the relay resets to “no alarm condition” state when a critical alarm is reset (acknowledged).

Symbol	Description	Default	Function
Relay Rst Enable	Function	ON	ON = Relays reset when an active alarm is reset (acknowledged). OFF = The alarm relay remains active even if the alarm is acknowledged (it is useful to keep ventilation system running until concentration is below the alarm threshold).

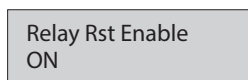

5.6.2 Alarm reset duration

This defines how long the alarm reset is active (alarm acknowledged).

Time
300

Symbol	Description	Default	Function
Reset Alarm Time	Relay Rst Enable Function	300	Defines how many seconds the alarm reset condition is active. If the alarm condition has not cleared within this time, the alarm will be re-activated without any further delay (Buzzer, and if configured, also the relay) 0: The alarm reset function is disabled.

5.7 Alarm Settings

Reading and changing (only via code level 1) of Alarm Settings.

MP 1 active  Warning limit C 5000 ppm

5.7.1 Room mode

This function is only available for measuring point 2 (MP2). It defines if the sensors share the critical relay and the warning relay (both sensors mounted in same room) or each sensor has 1 critical relay each (two rooms with one sensor).

In the menu structure, this setting is accessible under sensor 2 only (MP2).

Room Mode
1 Room

Symbol	Description	Default	Function
Room Mode	Function	1 Room	1 Room: Relay 1 is used as warning relay for both sensors and relay 3 is used as critical relay for both sensors. 2 Rooms: Relay 1 is used as a critical relay for sensor 1 and relay 3 is used as critical relay for sensor 2.

5.7.2 Alarm limits

For each sensor head two alarm thresholds are available for free definition. If the gas concentration is higher than the set alarm threshold, the associated alarm is activated. If the gas concentration falls below the alarm threshold inclusive hysteresis, the alarm is reset again.

The hysteresis of both alarm is 5% of the default alarm threshold (e.g. with 5000 ppm this corresponds to 250 ppm).

Note: With propane (R290), the alarm status will not auto-clear if the measured ppm-value has exceeded the max-range of the sensor element. In this case the concentration may be as indicated OR it may still be above the max-range. The alarm must be manually cleared and the room checked before entry.

Warning limit
C 5000 ppm



Critical limit
C 5000 ppm



Delay Alarm ON
0 sec.



5.7.3 Alarm relay

For setting the alarm delay for Critical and Warning alarms.

Symbol	Description	Default	Function
0 sec.	Delay Alarm	0 sec.	Gas concentration > alarm threshold + set time = Alarm ON Gas concentration < alarm threshold - hysteresis = Alarm OFF

5.8 AO Settings

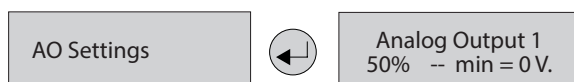

This menu is for the configuration of the analogue outputs.

If more than one sensor head is present, the maximum value of the two measurements is assigned to the output.

Using this function, it is possible to configure the output signal.

The CO₂ sensor with a range of 0 – 20000 ppm has an output signal of 0 – 10 V corresponding to 0 – 10000 ppm as default.

As an example this may be changed to e.g. 2 – 10 V for 0 – 20000 ppm by changing settings to “100%” and “2 V”.

Symbol	Description	Default	Function
50% 100%	Selection of the ppm measurement which will give the maximum output signal	50%	50% = at a concentration of 50% of the sensor head range the output will be set to 10 V (20 mA without JP5 mounted) 100% = at a concentration of 100% of the sensor head range the output will be set to 10 V (20 mA without JP5 mounted)
--	DANFOSS ONLY SETTING	--	Do not change – If doing so, a small “noise signal” (step form) on top of the measured ppm value with a duty cycle of app. 180s is activated.
0 V 2 V	Selection of minimum output signal	0 V	0 V = at the minimum measuring signal of the sensor, the output will be set to 0V (0 mA without JP5 mounted) 2 V = at the minimum measuring signal of the sensor, the output will be set to 2 V (4 mA without JP5 mounted)

The analogue output signal depends on above settings and the configuration of jumper JP5. The output signal is continuously monitored by the DGS. If the value deviates by more than 5% from the expected value, an Error Message is generated. This might happen if the output is short-circuited. If configured for current output (JP5 open) the alarm is also generated if the output is open-circuited. In below examples, it is assumed that the output is in voltage (JP5 closed) and that a 0 – 20000 ppm sensor is used.

The analogue output signal, AO is calculated by this formula:

$$AO = \frac{\text{ppm value}}{\text{ppm range}} \times \text{AO range} + \text{AO min.}$$

Example 1 (default settings):

“AO output max. scaling” = 50%
 “AO min. value” = 0 (default)

This means that in the formula:

- AO range = 10 V
- AO min. = 0 V
- ppm range = 10000 ppm

Hence, a measured value of 4000 ppm will result in the following output value:

$$AO = \frac{4000 \text{ ppm}}{10000 \text{ ppm}} \times 10 \text{ V} + 0 \text{ V} = 4 \text{ V}$$

Example 2:

“AO output max. scaling” = 100%
 “AO min. value” = 2 V

This means that in the formula:

- AO range = 8 V
- AO min. = 2 V
- ppm range = 20000 ppm

Hence, a measured value of 4000 ppm will result in the following output value:

$$AO = \frac{4000 \text{ ppm}}{20000 \text{ ppm}} \times 8 \text{ V} + 2 \text{ V} = 3.6 \text{ V}$$

5.9 Operating Data

This menu is for retrieving relevant operational data from the sensor head. No changes or modifications are possible.

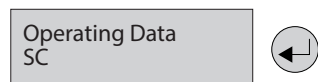
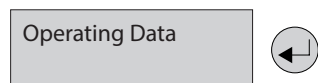

If more than one sensor head is connected to the DGS, the selection is done at X.

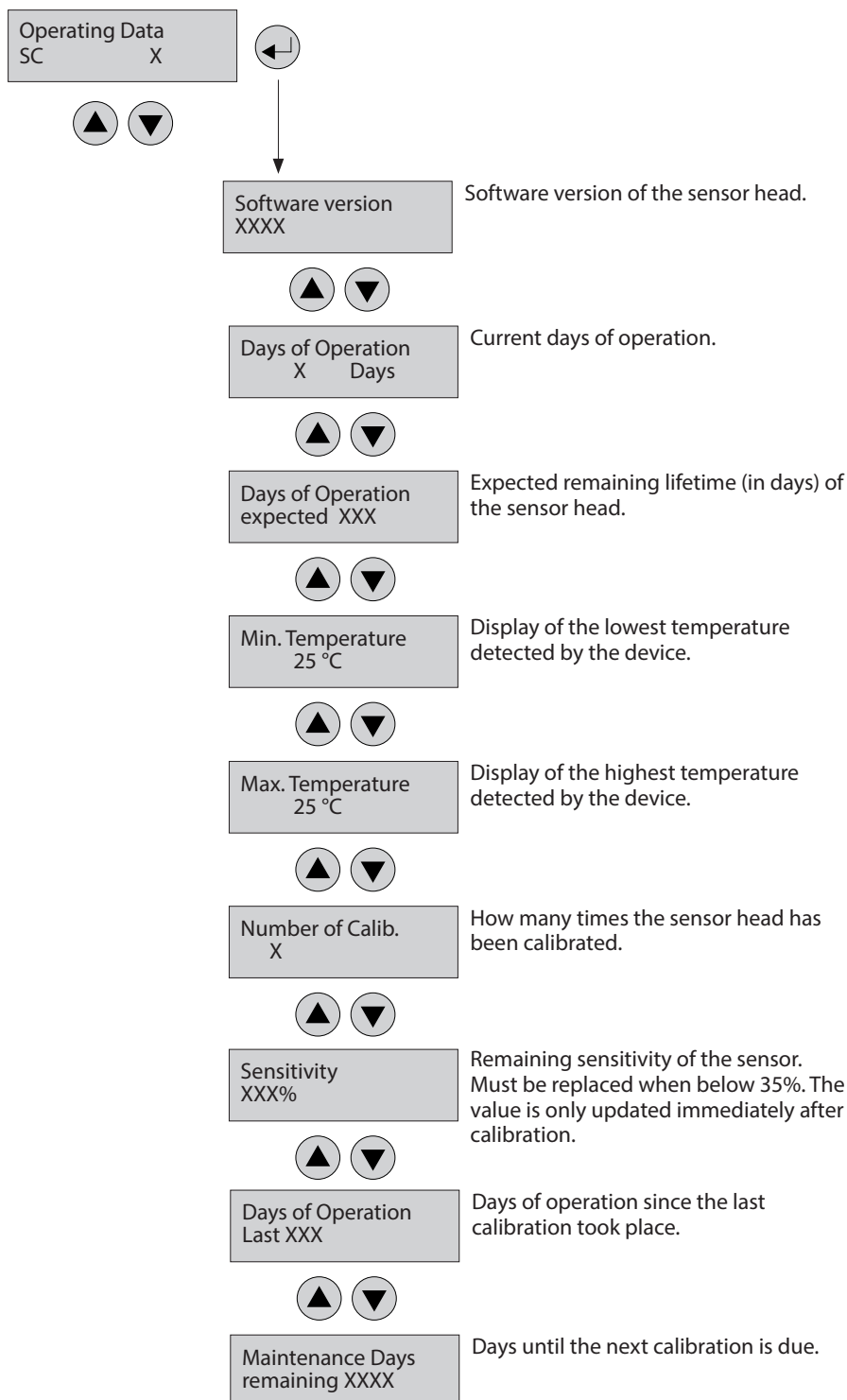

5.10 Calibration

This section gives an overview of the calibration menu.
 The calibration description can be found on the following pages.
 For HFC, remember to use the specified calibration gas.
 (HFC grp 1 = R1234yf, grp 2 = R134a, grp 3 = R407c)

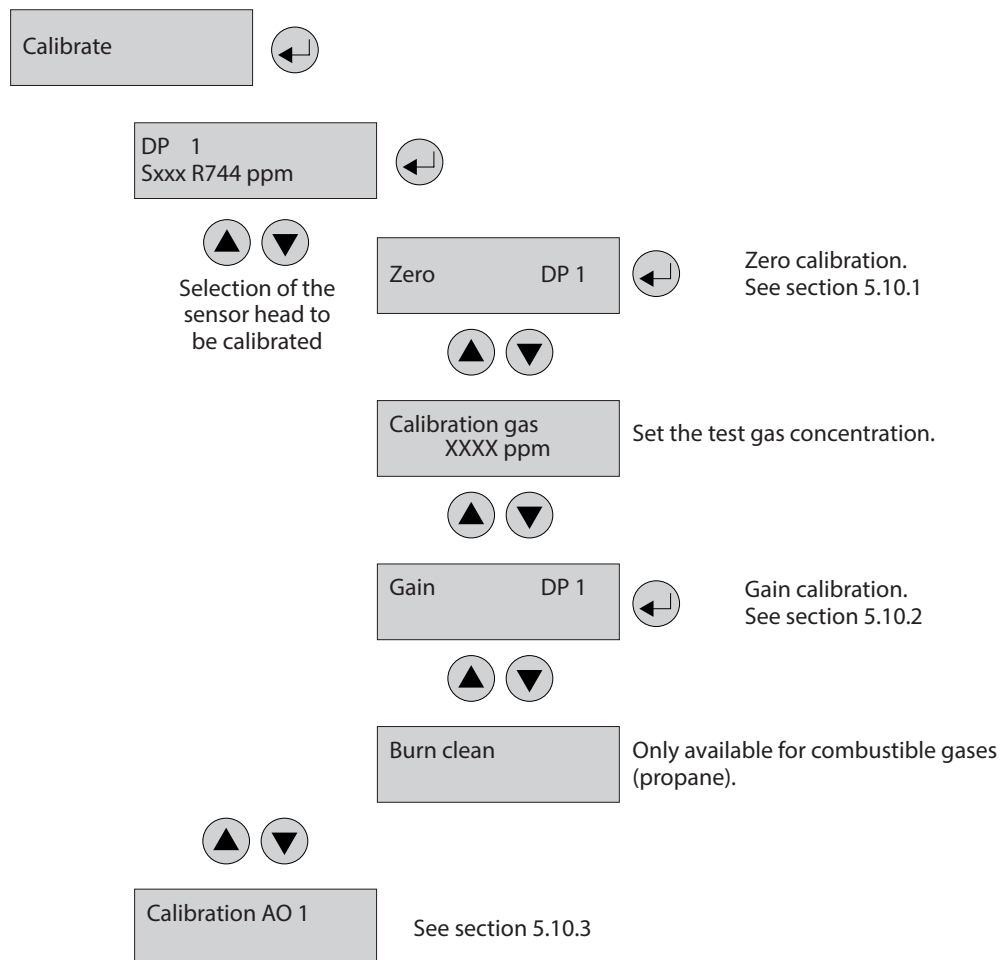

5.10.1 Zero calibration

The stepwise calibration process is described below.

Note: The specified warm-up times etc. must be strictly observed before starting the calibration process.

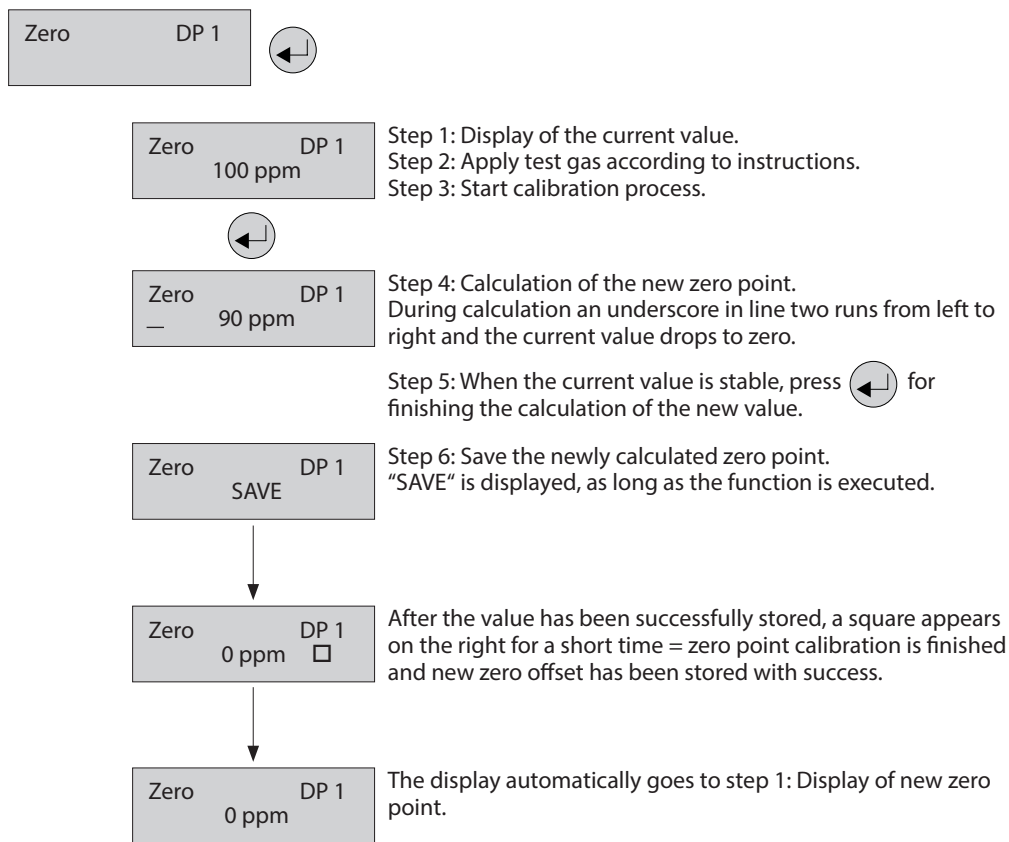

During the calculation phase, the following messages may occur:

Message	Description
Current value too high	Wrong gas for zero point calibration or sensor element defective. Replace sensor head.
Current value too small	Wrong gas for zero point calibration or sensor element defective. Replace sensor head
Current value unstable	Appears when the sensor signal does not reach the zero point within the target time. Disappears automatically when the sensor signal is stable.
Time too short	The message "value unstable" starts an internal timer. Once the timer has run out and the current value is still unstable, the text is displayed. The process starts over again. If the value is stable, the current value is displayed and the calibration procedure is continued. If the cycle is repeated several times, an internal error has occurred. Stop the calibration process and replace the sensor head.
Internal error	Calibration is not possible → check if burning clean process is completed or interrupt it manually or check/replace sensor head.

If aborting the zero offset calibration, the offset value will not be updated. The sensor head continues to use the "old" zero offset. A full calibration routine must be conducted to save any calibration change.

5.10.2 Gain calibration

The stepwise calibration process is described below.

Note: The specified warm-up times etc. must be strictly observed before starting the calibration process.

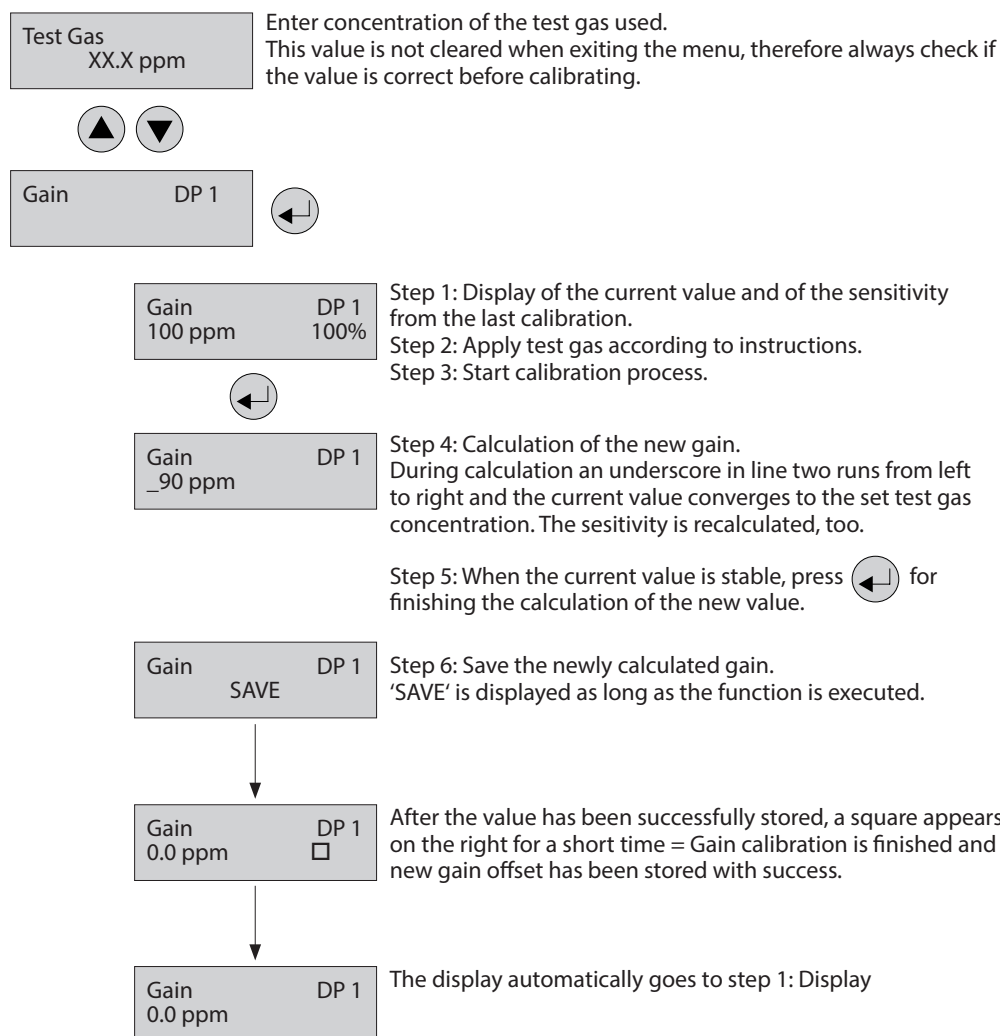

During the calculation phase, the following messages may occur:

Message	Description
Current value too high	Test gas concentration > than set value Internal error → replace sensor head
Current value too low	No test gas or wrong test gas applied to the sensor.
Test gas too high Test gas too low	The set test gas concentration must be between 30% and 90% of the measuring range.
Current value unstable	Appears when the sensor signal does not reach the calibration point within the target time. Disappears automatically when the sensor signal is stable.
Time too short	The message "value unstable" starts an internal timer. Once the timer has run out and the current value is still unstable, the text is displayed. The process starts over again. If the value is stable, the current value is displayed and the calibration procedure is continued. If the cycle is repeated several times, an internal error has occurred. Stop the calibration process and replace the sensor head.
Sensitivity <	Sensitivity of the sensor head < 30%, calibration no longer possible → replace sensor head.
Internal error	Calibration is not possible → check if burning clean process is completed or interrupt it manually or check/replace sensor head.

5.10.3 Zero point calibration of analogue output

With this menu item you can adjust the zero point of the analogue output (4mA). The zero point correction is only possible when the minimum output is 2 V or 4 mA, i.e. not possible when minimum output is 0 V or 0 mA.

The error message of the output monitoring is suppressed as long as the menu Calibration AO is open. Therefore, connect the ampere meter (measuring range 20 mA DC) to the analogue output only after having opened the menu.

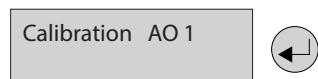

Connect ampere meter to the analogue output.

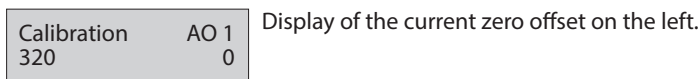

Display of the current zero offset on the left.

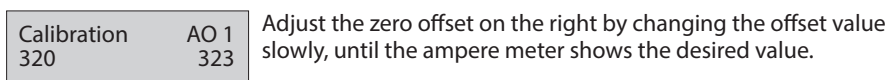

Adjust the zero offset on the right by changing the offset value slowly, until the ampere meter shows the desired value.



Save the adjusted zero offset.

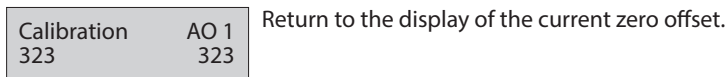

Return to the display of the current zero offset.

5.11 Addressing

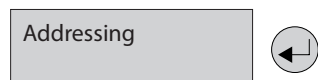

Assignment of the MODBUS address of the device for system integration, e.g. with Danfoss front end type AK-SM 800.



Define the MODBUS address.

Symbol	Description	Default	Function
4	MODBUS Address	0	0 = Device is not addressed, BUS not used. Max. value is 240.

6. MODBUS menu survey

Function	Min.	Max.	Factory	Unit	AKM name
Gas level					
Sensor 1 Actual gas level in % of range	0.0	100.0	-	%	Gas level %
Sensor 1 Actual gas level in ppm	0	FS ¹⁾	-	ppm	Gas level ppm
Sensor 2 Actual gas level in % of range	0.0	100.0	-	%	2: Gas level %
Sensor 2 Actual gas level in ppm	0	FS ¹⁾	-	ppm	2: Gas level ppm
Alarms					
Alarm settings					
Indication of critical alarm (critical alarm of Gas 1 or Gas 2 active) 0: No active alarm(s) 1: Alarm(s) active	0	1	-	-	GD alarm
Common indication of both critical and warning alarm as well as internal and maintenance alarms 0: No active alarm(s), warning(s) or errors 1: Alarm(s) or warning(s) active	0	1	-	-	Common errors
Gas 1 Critical limit in %. Critical limit in % (0-100)	0.0	100.0	HFC: 25 CO ₂ : 25 R290: 16	%	Crit. limit %
Gas 1 Critical limit in ppm Critical limit in ppm; 0: Warning Signal deactivated	0	FS ¹⁾	HFC: 500 CO ₂ : 5000 R290: 800	ppm	Crit. limit ppm
Gas 1 Warning limit in % (0-100)	0	100.0	HFC: 25 CO ₂ : 25 R290: 16	%	Warn. limit %
Gas 1 Warning limit ppm 0: Warning Signal deactivated	0.0	FS ¹⁾	HFC: 500 CO ₂ : 5000 R290: 800	ppm	Warn. limit ppm
High (critical and warning) alarm delay in seconds, if set to 0: no delay	0	600	0	sec.	Alarm delay s
When set to 1, the Buzzer is reset (and the relays if defined: Relay reset enable) to no alarm indication. When the alarm is reset or the time-out duration is exceeded, the value is reset to 0. Note: The alarm condition is not reset - only the output indication is reset. 0: Alarm outputs not reset 1: Alarm outputs reset-Buzzer muted and relays reset if configured	0	1	0	-	Reset alarm
Duration of alarm reset before automatic re-enable of alarm outputs. A setting of 0 disables the ability to reset alarm.	0	9999	300	sec.	Reset alarm time
Relay reset enables: Relay reset with alarm acknowledge function 1: (default) Relays will be reset if the alarm acknowledge function is activated 0: Relays remain active until the alarm condition clears	0	1	1	-	Relay rst enable
Gas 2 Critical limit in %. Critical limit in % (0-100)	0.0	100.0	CO ₂ : 25	%	2: Crit. limit %
Gas 2 Critical limit in ppm Critical limit in ppm; 0: Warning Signal deactivated	0	FS ¹⁾	CO ₂ : 5000	ppm	2: Crit. limit ppm
Gas 2. Warning limit in % (0-100)	0	100.0	CO ₂ : 25	%	2: Warn. limit %
Gas 2. Warning limit ppm 0: Warning Signal deactivated	0.0	FS ¹⁾	CO ₂ : 5000	ppm	2: Warn. limit ppm
High (critical and warning) alarm delay in seconds, if set to 0: no delay	0	600	0	sec.	2: Alarm delay s
Configuration of relays for one or two rooms' application mode. 1: One room with two sensors sharing the same warning relay and critical relay 2: Two rooms with one sensor in each, and each sensor having a critical alarm relay. In this mode, warning alarms activate as normal on the LED indicator, hand-held Service Tool and on MODBUS.	1	2	1	-	2: Room Mode
Service					
Status of the sensors' warm-up period 0: Ready 1: Warming up one or more sensors	0	1	-	-	DGS Warm-up

¹⁾ The max. alarm limit for CO₂ is 16.000 ppm / 80% of full scale. All other values equal the full scale range of the specific product.

Readout the attached gas sensor type. 1: HFC grp 1 R1234ze, R454C, R1234yf R1234yf, R454A, R455A, R452A R454B, R513A 2: HFC grp 2 R407F, R416A, R417A R407A, R422A, R427A R449A, R437A, R134A R438A, R422D 3: HFC grp 3 R448A, R125 R404A, R32 R507A, R434A R410A, R452B R407C, R143B 4: CO ₂ 5: Propane (R290)	1	5	N	-	Sensor type
Full scale range	0	32000	HFC: 2000 CO ₂ : 20000 R290: 5000	ppm	Full scale ppm
Gas 1 Days until next calibration	0	32000	HFC: 365 CO ₂ : 1825 R290: 182	days	Days till calib
Gas 1 Estimates how many days remaining for sensor 1	0	32000	-	days	Rem.life time
Status of the critical alarm relay: 1: ON = no alarm signal, coil under power - normal 0: OFF = alarm signal, coil depowered, alarm situation	0	1	-	-	Critical Relay
Status of the warning relay: 0: OFF = inactive, no warning active 1: ON = active warning, coil under power	0	1	-	-	Warning Relay
Status of the Buzzer: 0: inactive 1: active	0	1	-	-	Buzzer
Gas 2 Days until next calibration	0	32000	HFC: 365 CO ₂ : 1825 R290: 182	days	2: Days til calib.
Gas 2 Estimates how many days remaining for sensor 2	0	32000	-	days	2: Rem.life time
Activates a mode which simulates an alarm. Buzzer, LED and relays all activate. 1:-> Test function - no alarm generation possible now Automatically falls back to Off after 15 min. 0: back to normal mode	0	1	0	-	Test Mode
Analogue output max. scaling 0: zero to full scale (e.g (Sensor 0 – 2000 ppm) 0 – 2000 ppm will give 0 – 10 V) 1: zero to half scale (e.g (Sensor 0 – 2000 ppm) 0 – 1000 ppm will give 0 – 10 V)	0	1	HFC: 1 CO ₂ : 1 R290: 0	-	AOmax = half FS
Analogue output min. value 0: select 0 – 10 V or 0 – 20 mA output signal 1: select 2 – 10 V or 4 – 20 mA output signal	0	1	0	-	AOmin = 2V/4mA
Alarms					
Critical Limit alarm 0: OK 1: Alarm. Gas limit exceeded and delay expired	0	1	-	-	Critical limit
0: OK 1: Fault. Out of range under test – over range or under range	0	1	-	-	Out of range
0: OK 1: Fault. Sensor and head failures	0	1	-	-	Wrong SensorType
0: OK 1: Fault. Sensor out or removed, or wrong sensor connected	0	1	-	-	Sensor removed
0: OK 1: Warning. Due for calibration	0	1	-	-	Calibrate sensor
0: OK 1: Warning. Gas level above warning level and delay expired	0	1	-	-	Warning limit
Indication if the normal alarm function is inhibited or in normal operation: 0: Normal operation, i.e. alarms are created and cleared 1: Alarms inhibited, i.e. alarm status is not updated, e.g. due to DGS in test mode	0	1	-	-	Alarm inhibited

User Guide | Danfoss Gas sensor, type DGS

Critical Limit alarm 0: OK 1: Alarm. Gas limit exceeded and delay expired	0	1	-	-	2: Criti. limit
0: OK 1: Fault. Out of range under test – over range or under range	0	1	-	-	2: Out of range
0: OK 1: Fault. Sensor and head failures	0	1	-	-	2: Wrong SensType
0: OK 1: Fault. Sensor out or removed, or wrong sensor connected	0	1	-	-	2: Sens. removed
0: OK. Sensor not due for calibration 1: Warning. Due for calibration	0	1	-	-	2: Calibrate sens.
0: OK 1: Warning. Gas level above warning level and delay expired	0	1	-	-	2: Warning limit

7. Ordering

DGS Sensors		
Product Description	Code no.	
DGS-SC HFC grp 1*	080Z2803	
DGS-SC HFC grp 2*	080Z2804	
DGS-SC HFC grp 3*	080Z2805	
DGS-PE propane	080Z2806	
DGS-IR CO ₂	080Z2800	
DGS-IR CO ₂ 5 m	080Z2801	
DGS-IR 2 * CO ₂ - 5 m	080Z2802	
DGS-SC HFC grp 1* + B&L	080Z2809	
DGS-SC HFC grp 2* + B&L	080Z2810	
DGS-SC HFC grp 3* + B&L	080Z2811	
DGS-PE propane + B&L	080Z2812	
DGS-IR CO ₂ + B&L	080Z2807	
DGS-IR CO ₂ 5 m + B&L	080Z2808	

Spares and accessories			
Product Description		Code no.	
Spare sensor HFC grp 1*	Spare	080Z2815	
Spare sensor HFC grp 2*	Spare	080Z2816	
Spare sensor HFC grp 3*	Spare	080Z2817	
Spare sensor propane	Spare	080Z2818	
Spare sensor CO ₂	Spare	080Z2813	
Spare sensor CO ₂ - 5 m	Spare	080Z2814	
Hand-held Service Tool	Accessory	080Z2820	
Strobe & Horn	Accessory	080Z2819	
Splash guard	Accessory	148H6226	
Duct set	Accessory	148H6236	
Calibration adaptor	Accessory	148H6232	
Remote kit	Accessory	148H6238	
Power Supply AK-PS 063	Accessory	080Z0057	

* HFC grp 1: R1234ze, R454C, **R1234yf**, R454A, R455A, R452A, R454B, R513A

HFC grp 2: R407F, R416A, R417A, R407A, R422A, R427A, R449A, R437A, **R134A**, R438A, R422D

HFC grp 3: R448A, R125, R404A, R32, R507A, R434A, R410A, R452B, **R407C**, R143B

Bold = calibration gas

Note: DGS is also available for alternative refrigerant gases on request. Please contact your local Danfoss sales office for details.

Danfoss A/S

Climate Solutions • danfoss.com • +45 7488 2222

Any information, including, but not limited to information on selection of product, its application or use, product design, weight, dimensions, capacity or any other technical data in product manuals, catalogues descriptions, advertisements, etc. and whether made available in writing, orally, electronically, online or via download, shall be considered informative, and is only binding if and to the extent, explicit reference is made in a quotation or order confirmation. Danfoss cannot accept any responsibility for possible errors in catalogues, brochures, videos and other material. Danfoss reserves the right to alter its products without notice. This also applies to products ordered but not delivered provided that such alterations can be made without changes to form, fit or function of the product.
All trademarks in this material are property of Danfoss A/S or Danfoss group companies. Danfoss and the Danfoss logo are trademarks of Danfoss A/S. All rights reserved.
