

Intelligent variable frequency drives for every HVACR application



Contents

Introduction

– Unlock HVACR intelligence 3

iC7-HVACR features

– Intelligent 4

– Efficient 5

– Easy 6

– Reliable 7

– Designed for your needs 8

– Your ambition. Our drive 11

iC7-HVACR ULH 12

Applications 15

Digital tools

MyDrive® Suite 16

DrivePro® services 18

Specifications, ratings, and dimensions

Frequency converters

– Key specifications 20

– Connection diagrams 22

– Drive selection made easy 23

– Quick selection iC7-HVACR 24

– Ratings iC7-HVACR 27

– Quick selection
iC7-HVACR ULH 28

– Ratings iC7-HVACR ULH 29

– Dimensions and weight 31

– Model code 32

– Options 34

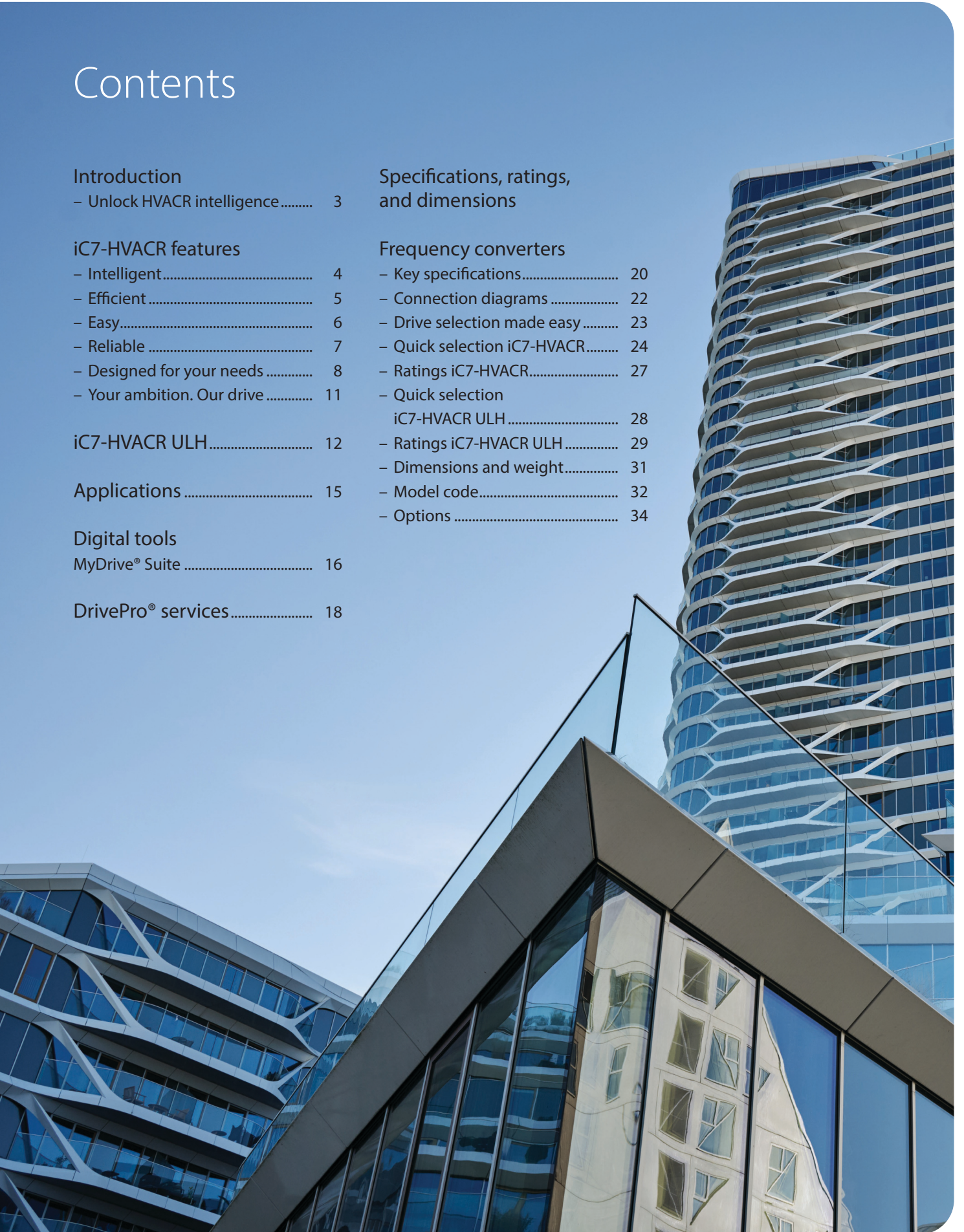

Unlock HVACR intelligence

The Danfoss iC7-HVACR variable frequency drives (VFDs) offer exceptional performance, thanks to 35 years of HVACR expertise and a history of five million units installed in heating, ventilation, air conditioning, and refrigeration (HVACR) systems.

These drives deliver high efficiency and help minimize the total cost of ownership of your HVACR assets. Use iC7-HVACR to solve the challenges of systems and applications using intelligent and user-friendly control, ensuring maximal uptime and reliability. This drive is not only built for today's demands but is also ready for the challenges of tomorrow, with a strong focus on digitalization, cybersecurity, and sustainability.

Advanced ultra low-harmonic drive

The iC7-HVACR ULH variant features an active rectifier for superior power quality, minimal losses, and exceptional THDi (<3% at full load). This compact and lightweight design is ideal for environments that demand efficient integration and best-in-class power quality.

Unmatched cybersecurity

With leading hardware-based cybersecurity, your HVACR investment is well protected. A built-in crypto chip on the control unit provides robust defense against unauthorized access. Data transfer during datalogging and software downloads is fully encrypted to maintain integrity. Malicious firmware is prevented, guaranteeing only authentic versions are used, and encrypted software protects locally stored data.

Drive selection made easy

Highlights

- > Small footprint: Lightweight IP55 enclosures and compact IP20 modules provide flexible installation options
- > Cybersecurity: Advanced hardware-based protection prevents security breaches and safeguards your property
- > HVACR intelligence: Improved system intelligence includes more sensors, analytics, and future-proof connectivity for optimized performance
- > EMC compliance: Built-in EMC filters prevent electrical interference (Categories C1, C2, and C3)
- > Integrated fieldbuses: Built-in fieldbus technology enables seamless communication without extra hardware
- > Ultra low-harmonic: The iC7-HVACR ULH variant achieves ultra-low THDi (<3% at full load), protecting equipment from overheating and malfunction



Reach <3% THDi
with ULH drives

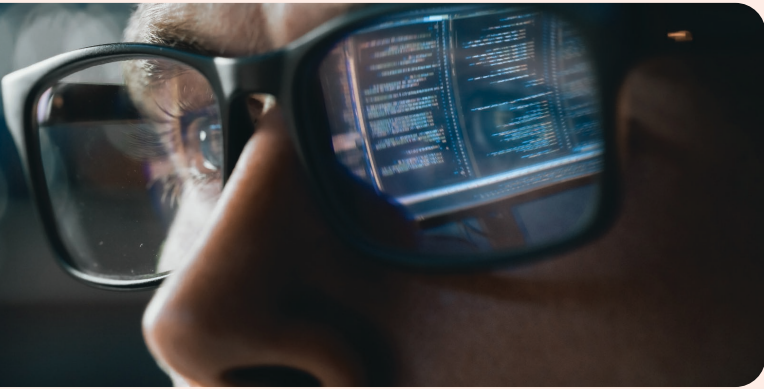

Make smart choices for HVAC systems, with integrated intelligence

Intelligent

Advanced AHU controller

Reduces costs and complexity by integrating I/O points. As a result, you can enhance AHU performance with fewer components and fewer connections.

Wide range of high-resolution sensors

Delivers precise temperature control and comfort by supporting a wide range of high-resolution sensors, eliminating the need for external controllers and increasing system accuracy.

Sensor calibration

Guarantees accurate measurements for optimal control, saving time and costs on external calibration while ensuring comfort and low energy usage.

Built in psychrometric chart for wet bulb temperature

Enhances comfort and de-humidification control while optimizing cooling tower performance, resulting in greater efficiency and an improved indoor environment.

Enhanced connectivity with MQTT

Enables seamless IoT integration and scalability by allowing data to be tailored to specific needs, simplifying connection to digital services.

Integrated sensors to enhance analytics capability

Instantly detects grid disturbances to ensure robust performance during power loss, enhancing system reliability and uptime with integrated analytics.

Built in pump intelligence

Provides accurate flow measurement reducing system cost and complexity by eliminating the need for additional control hardware.

Sensor calibration

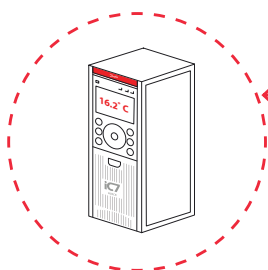

Temperature measurement without calibration

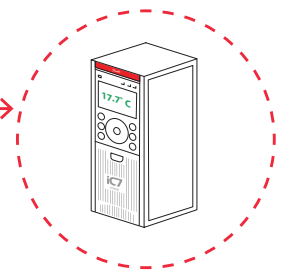
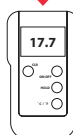
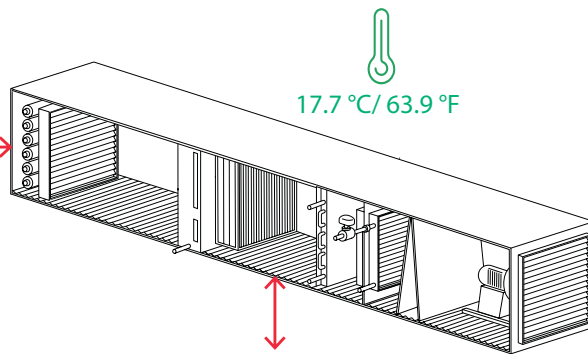

Calibrated temperature measurement



Reduce operating cost via energy efficiency, enhanced design, and reduced maintenance

Efficient

Adapts quickly to optimize performance of any motor technology

An easy motor adaptation process means you are up and running with optimum efficiency for any motor type, in just seconds. The iC7 drive delivers superior shaft performance even at low speed.

Highly efficient ULH drive

The ultra low-harmonic (ULH) variant ensures compliance with standards and reduces energy bills by minimizing heat loss while optimizing harmonic performance. Market-leading efficiency for part-load operation.

Compact design

Saves on system design costs and reduces panel space requirements, allowing for more flexible and economical installation options.

Boosted efficiency

Lowers your energy bill and helps you meet decarbonization targets faster by minimizing energy consumption during full- and part-load operation.

Back-channel cooling

Redirects 90% of heat out of the panel, significantly reducing cooling needs in the control rooms, because the heat can be directed outside. Provides a faster return on investment.

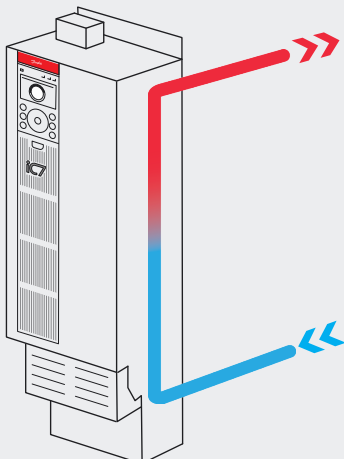

Remove 90% of heat from the panel or control room



Ease of use saves time and reduces effort throughout product service life

Easy

Connects to any type of motor

Offers the freedom to use your preferred motor technology with an easy setup and motor adaptation process for maximum flexibility.

Intuitive user interface

Enables fast commissioning with an HVACR-specific interface that requires no special training, making setup quick and user-friendly.

Slider terminal and easy-connect power terminal

Simplifies power cable connections, saving significant time during installation and service.

MyDrive® digital tools

Provides a complete suite of tools accessible from any web browser, offering everything you need without requiring software downloads.

Supported by MyDrive® Energy tool

Allows you to know your energy saving potential upfront and easily calculate your system's overall energy efficiency from day one.

Broader hardware portfolio with full range offering

Offers a complete range of hardware options, ensuring easy serviceability and providing the perfect fit for any application requirement.

Disconnect switch and fuse option for IP21 and IP55 enclosures

Reduces panel costs by eliminating the need for an external mains switch and fuse, integrating these components directly.

Intuitive user interface



- No special training required for programming
- Speaks the language of your applications and processes
- Commissioning in no time



Secure reliable uptime with safe and cyber-secure operation

Reliable

Cybersecure-by-design with hardware-enabled crypto chip

Protects against cyber threats with a hardware crypto chip. Enabling system level security and keeping your operations safe from attacks. Prepared for upgrade to security level 3, SL3.

Wide range of operating temperatures

Ensures reliable performance in extreme climates from -30 °C to 60°C, allowing for optimized and more flexible panel design.

Functional safety with built in diagnostics

Reduces costs by eliminating external safety devices while ensuring safe, reliable operation for critical applications with its built-in diagnostics. Achieve STO SIL3 /PLe as per EN62061/ISO13849-1.

Condition-based monitoring

Maximizes uptime with edge computing for condition-based monitoring, providing critical insights without requiring a cloud connection for enhanced reliability.

Advanced Fire Mode

Ensures safe building evacuation during a fire by maintaining critical air pressure on each floor, prioritizing occupant safety.

Integrated sensors to enhance analytics capability

Delivers reliable operation in critical applications like hospitals by using integrated sensors to monitor grid parameters in real time and act instantly.

Low GWP compliant

Enables low-emission operation and ensures reliable performance for chiller applications that use A2L refrigerants, enhancing safety and compliance.

Protect critical equipment, for reliable operation. Wide portfolio of low-harmonic solutions

Standard drive solutions

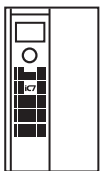

Drive with traditional built-in choke

~40% THDi

Low-harmonic solutions

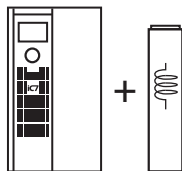

Drive + passive filter

5-10% THDi

Ultra low-harmonic (ULH) solutions

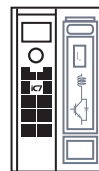

ULH drive

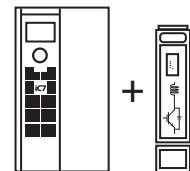

Drive + active filter

Use one active filter to mitigate multiple drives

3-5% THDi

Designed for your needs

The iC7 drive is configured and delivered to meet your exact requirements, saving expensive installation time. EMC and harmonic filters are integrated. Fuse and disconnect are also available built-in, for IP21/UL Type 1 and IP54/IP55/UL Type 12 enclosures.

Control and option boards can be pre-configured at the factory or easily upgraded in the field.

Enclosures fit for installation

Install this space-saving drive easily in cabinets and protected rooms:

- Bookstyle IP20/UL Open Type optimized in width for side-by-side mounting without clearance, to save cabinet space (*Frames FA02-FA12*)
- Designed for flexible installation with minimum use of space
 - IP21/UL Type 1 for frames FK03-FK12
 - IP54/IP55/UL Type 12 for frames FB03-FB12 (*IP55: FB03-FB08, IP54: FB09-FB12*)

Filters and accessories

For a complete installation, a range of integrated and separate filter options are available.

High power density cooling

You get high power density thanks to superior heat management using heat-pipe technology and high-performance heat sinks. Closed air ducts enable flexible mounting, and back-channel cooling supports removal of heat to the external surroundings without extra cooling equipment. Remove fans easily for cleaning and service.

Fast installation and service

Focus on ease of installation and service has been a key driver during development, with intensive installation testing during the design phase to ensure easy installation and user access.

Easy to use:

- Slider power and motor terminals for ease of connection
- Control connectors are pluggable
- Power and motor connectors are also pluggable for units up to 43 A (IP20, 22 kW)
- Connectors are color-coded and clearly marked for easier identification

Environmental exposure

The iC7 drive delivers exceptional performance under demanding operating conditions, and its design criteria match the environments described in the IEC60721 standard.

This drive operates in a wide temperature range of -30 °C to 60 °C, ensuring consistent performance in any climate. For specific adjustments, refer to the derating guidelines in the Design Guide. With an altitude capability of up to 4400 m (14400 ft) above sea level, you can install this drive in virtually any location, with correct derating. For additional protection, specify the optional coated printed circuit boards increasing corrosion resistance.

This robust drive matches the required vibration resistance for operation in cabinets, in control rooms and on machines. Designed to meet the vibration levels for environments categorized as 3M12.

Supports these communication protocols with no additional hardware



EtherNet/IP™



MQTT



EtherCAT®

Prevent problems and improve uptime with condition-based monitoring (CBM)

Integrated condition-based monitoring (CBM) functionality leverages built-in and connected sensors to deliver real-time data analytics, self-monitoring, and lifetime assessment. This enables proactive maintenance, minimizing downtime and maximizing the lifespan of your equipment, using

- Motor stator winding monitoring
- Vibration monitoring
- Load envelope monitoring

Using edge computing, these functions are performed within the drive, in real time. No Internet or cloud connection is required. This protects the drive from unauthorized access.

Scalable and flexible control

Enjoy a new level of performance thanks to the rapid-response control of iC7 drives.

The control capability is scalable and equipped with RS485 and EtherNet-based fieldbus and STO inputs as standard. Add more I/Os as needed, to match your applications.

For frequency converters, an optional basic I/O board offers typical I/O connectivity, and you can add more options if needed.

Switch fieldbus without changing boards

You can change the application or fieldbus on your drive without changing the hardware. This gives you the ultimate in drive flexibility.

Customizations available:

- Modbus RTU OS7MR
- BACnet MSTP OS7BN
- Modbus TCP OS7MT
- BACnet IP OS7BI
- PROFINET RT OS7PR
- EtherNet/IP OS7IP
- EtherCAT OS7EC
- MQTT

Connect to a computer via the extra Ethernet port, enabling you to use MyDrive® commissioning or service tools.





Your ambition. Our drive

iC7 series puts you ahead of the competition with premium advantages

Quality in focus

Reliable and predictable operation has been a key driver. With an ISO 9001-certified and IATF 16949-compliant quality system combined with use of 6-Sigma principles, quality and reliability are at absolute market-leading standards.

Reliability is assured by design based on application load profiles and data collected from intensive simulations and feedback from testing.

Automated assembly enables close control and monitoring of critical processes. The finished drives are 100% full-load tested ensuring reliability before leaving the factory.

Engineering support

Danfoss provides an extensive selection of support material and tools to help in engineering, such as:

- Digital tools, such as MyDrive® Select, MyDrive® Harmonics and MyDrive® Energy
- EPLAN P8 macros
- Dimensional and electrical drawings

Secure-by-design

Cyber security is especially important in building infrastructure such as data centers, hospitals, and government facilities. Cyber attacks can disrupt building management systems, with serious consequences for safety of building occupants, and vital functions in society.

As the frequency of cyber attacks increases, legislation is changing. The iC7 series is ready for these changes.

Your drive is equipped with market-leading hardware-based protection against unauthorized access. A built-in crypto chip on the control unit enables encrypted network connectivity, tamper-proof hardware, trusted firmware operation, and public key certificates – for stronger authentication.

 [Learn more about security](#)



iC7-HVACR ULH: For compliant systems which are more cost-efficient

Highlights

- > Fully integrated and easy-to-use: Single unit 3-wire in, 3-wire out
- > Network distortion issues all under control
- > Ultra-low harmonics, < 3% THDi
- > Low supra harmonics levels
- > Generates no additional common-mode voltage
- > Power factor of 1.0
- > High efficiency, low losses
- > Unmatched compactness, less weight, and easy integration
- > Compliance-ready for the standards of tomorrow

The intelligent iC7 series includes a fully integrated solution for next-generation harmonic mitigation. The iC7-HVACR ultra low-harmonic drive is free of the shortcomings of traditional ultra low-harmonics solutions. With total harmonic signature of less than 3% THDi, the iC7-HVACR ULH frequency converter brings near-zero distortion to the electrical network, even at partial motor loads.

Zero compromise

Network distortion comes in many forms. With an advanced, next-generation rectifier, iC7-HVACR ULH has a lower common-mode noise signature, a lower high-frequency noise signature (also known as supra harmonics), and greater efficiency (lower losses) than conventional ULH drives. With its power factor of 1.0, there's also no additional reactive power to your network. This combination ensures ultra-low overall distortion to the supply network – for zero compromise.

Partial load? Keep performing

The iC7-HVACR ULH performs better than conventional ULH drives at partial loads. It delivers full THDi performance down to ~50% load and maintains excellent THDi performance at even lower loads.

Reduce system cost

Using iC7-HVACR ULH, expensive network components such as supply transformers and backup generators can be specified 10-25% smaller, since oversizing to handle high harmonic distortion is unnecessary. This can bring huge capital investment savings to large infrastructure projects.

No extras are required since everything is integrated:

ULH rectifier with associated components and EMC filters in a 3-wire-in, 3-wire-out package. There's no need for power factor correction banks, either.



Next-gen technology for ultra compactness

By embracing a combination of multi-level rectifiers and SiC solid-state electronic switches, iC7-HVACR ULH achieves a huge increase in switching frequency. In turn, the dimensioning of the drive's LCL input filter is significantly reduced. As a result, the iC7-HVACR ULH delivers superior performance at almost the same cost as conventional ultra low-harmonic drives.

The iC7-HVACR ULH is fully contained within a single wall- or cabinet-mountable frame.

Fewer losses

Losses are significantly lower both at full load and partial load, for iC7-HVACR ULH. Besides reduction of the LCL size, the use of SiC MOSFETs also reduces

conduction losses in the switches. Usually traditional ultra low-harmonic drives have twice the losses of standard drives, whereas the next generation iC7-HVACR ULH cuts these losses in half. As a result, the main issue of efficiency degradation when using ultra low-harmonic drives is diminished.

Energy efficient: Ideal for retrofits

It is well known that retrofitting variable speed drives to DOL (or across the line) systems can bring 20-60% energy savings. But adding drives can also overload existing electrical infrastructure to the extent that energy upgrade projects are not feasible.

This is where iC7-HVACR ULH comes into its own. Since the iC7-HVACR ULH brings ultra-low overall distortion, you can retrofit it to existing electrical

systems without creating this overload situation, and the energy savings will soon pay back the investment.

Better system reliability

The active rectifier of the iC7-HVACR ULH ensures stable operation despite unstable network power supply. Power dips and brown outs are easily handled whilst keeping the driven load fully operational and uninterrupted.

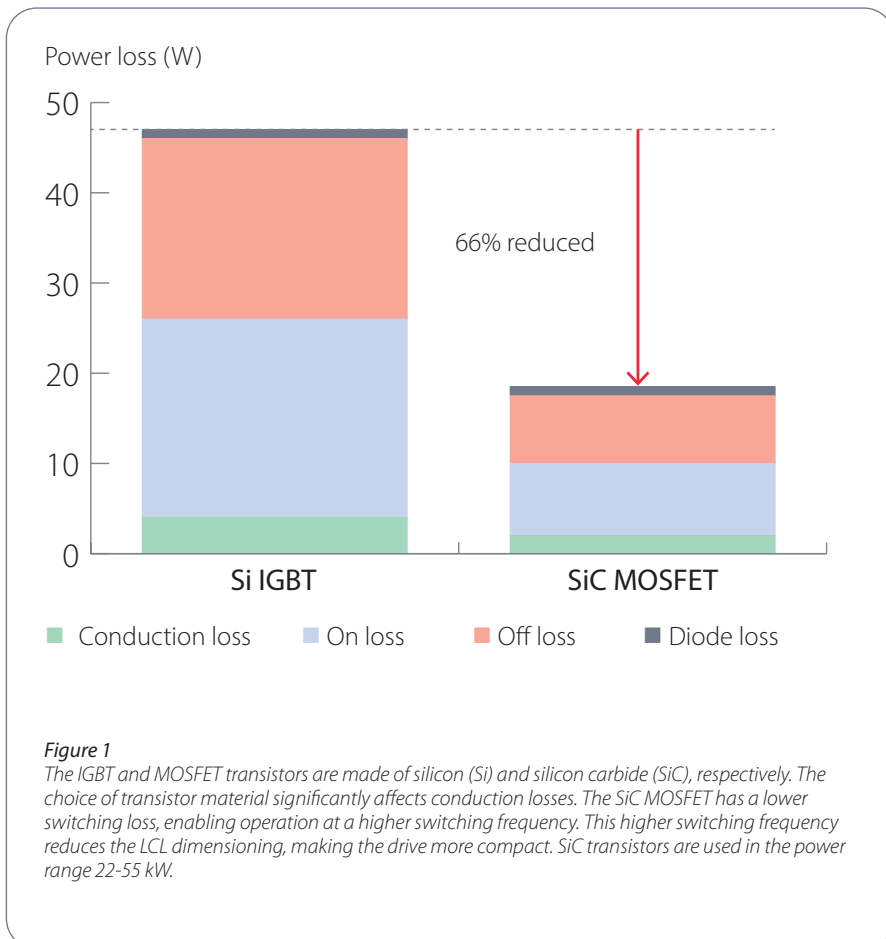

Figure 1

The IGBT and MOSFET transistors are made of silicon (Si) and silicon carbide (SiC), respectively. The choice of transistor material significantly affects conduction losses. The SiC MOSFET has a lower switching loss, enabling operation at a higher switching frequency. This higher switching frequency reduces the LCL dimensioning, making the drive more compact. SiC transistors are used in the power range 22-55 kW.

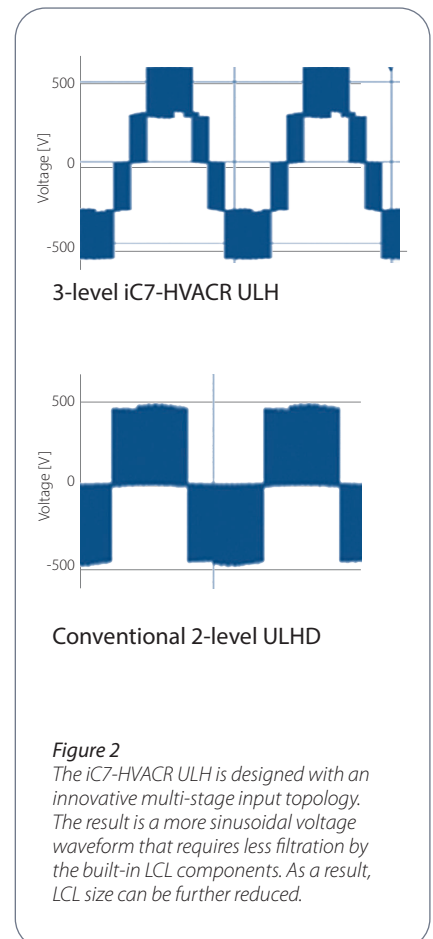

Figure 2

The iC7-HVACR ULH is designed with an innovative multi-stage input topology. The result is a more sinusoidal voltage waveform that requires less filtration by the built-in LCL components. As a result, LCL size can be further reduced.



Applications: Outstanding solutions



	Intelligent	Efficient	Easy	Reliable
Air handling units and roof top units (AHU and RTU)	<ul style="list-style-type: none"> – Widest range of temperature sensor support – Sensor calibration – Enhanced “drive as a controller” – Enhanced connectivity with MQTT 	<ul style="list-style-type: none"> – Boosted efficiency with improved AEO – Compact and lightweight design – Efficient back-channel cooling 	<ul style="list-style-type: none"> – Intuitive user interface – Easy power cable connection – Logic feature in MyDrive® Insight – End-to-end digital tools 	<ul style="list-style-type: none"> – Wide range of operating temperatures – Best-in-class EMC filter: C1 and C2 compliant – Hardware enabled crypto chip – Edge computing condition-based monitoring
Chilled-water or hot-water pump	<ul style="list-style-type: none"> – Built in pump intelligence – Free choice of motor technology – Enhanced connectivity with MQTT 	<ul style="list-style-type: none"> – Boosted efficiency with improved AEO – Compact and lightweight design – Highly efficient ultra low-harmonic drive 	<ul style="list-style-type: none"> – Intuitive user interface – Easy power cable connection – Logic feature in MyDrive® Insight – End-to-end digital tools 	<ul style="list-style-type: none"> – Best-in-class EMC: C1, C2 filter – Hardware-enabled cybersecurity – Integrated functional safety – Edge computing condition-based monitoring
Coolant distribution unit (CDU) for data centers	<ul style="list-style-type: none"> – Built in pump intelligence – Free choice of motor technology – Enhanced connectivity with MQTT 	<ul style="list-style-type: none"> – Boosted efficiency with improved AEO – Compact and lightweight design – Highly efficient ultra low-harmonic drive 	<ul style="list-style-type: none"> – Intuitive user interface – Easy power cable connection – Logic feature in MyDrive® Insight – End-to-end digital tools 	<ul style="list-style-type: none"> – Best-in-class EMC filter: C1 and C2 compliant – Hardware-enabled cybersecurity – Integrated functional safety – Edge computing condition-based monitoring
Air-cooled and water-cooled chillers	<ul style="list-style-type: none"> – Advanced motor operation – Integrated sensors to enhance performance – Choice of low-harmonic solutions 	<ul style="list-style-type: none"> – Boosted efficiency with improved AEO – Efficient back-channel cooling – Superior power density 	<ul style="list-style-type: none"> – Intuitive user interface – Superior power density – Logic feature in MyDrive® Insight – End-to-end digital tools 	<ul style="list-style-type: none"> – Hardware-enabled cybersecurity – Wide operating temperature range – Integrated functional safety – Edge computing: condition-based monitoring – Future-ready design for low GWP

MyDrive® Suite – Digital tools empower you

Need help to design your application, or select, set up, and maintain your drive? Danfoss provides a palette of digital tools to give you the information you need, at your fingertips. No matter which stage of the project you are at.

Select and dimension your drives

- Select the right drive based on motor and load characteristics
- Find general product, industry, and application information for drives from Danfoss

MyDrive® Select

Select and dimension your drive and motor based on calculated motor load currents as well as current, temperature and ambient limitations. MyDrive® Select matches your business needs with Danfoss Drives products.

Set up and service your drives

- Set up your drives to operate according to your requirements
- Monitor drive performance throughout the entire lifecycle of your drive

MyDrive® Insight

Get easy access to parametrize your Danfoss drives, locally or remotely. Use MyDrive® Insight for commissioning, monitoring, and troubleshooting.

The integrated Logic controller provides flexible logic blocks to support customers in programming. Flexible enough to replace a small PLC.

Validate performance of your drives

- Analyze the performance of your drives in relation to harmonics content
- Calculate the energy savings to be achieved when using drives
- Validate compliance to norms and standards

MyDrive® Harmonics

Estimate the benefits of adding harmonic mitigation solutions from the Danfoss product portfolio and calculate predicted system harmonic distortion. This tool provides a quick indication of installation compliance with the most recognized harmonic norms, and mitigation recommendations.

MyDrive® Energy

Estimate the energy savings and CO₂ reduction achievable by installing Danfoss drives to perform variable speed control of electric motors. Calculate efficiency class and part load efficiency for drives from Danfoss. MyDrive® Energy supersedes the tools MyDrive® ecoSmart and VLT® EnergyBox.

MyDrive Virtual

Want to de-risk while speeding up product development? MyDrive Virtual lets you run high-fidelity simulations in your preferred simulation environment. Use the same control firmware and application software in a 1:1 virtual drive. Choose what you need from a wide variety of drive models

Simulation reduces time to market

Remove the constraints of the physical environment and open up new opportunities using iC7 simulation models which perfectly mirror the inverter or drive.

You can predict performance, test scenarios, streamline commissioning, and collaborate across teams and locations in an open environment.

Reliably validate interoperability of systems, using high-fidelity hardware-in-the-loop (HIL) simulation support from Danfoss.

The iC7 platform is founded on model-based design, which ensures the simulation models are always valid: up to date and accurate.

These models comply with the FMI standard and are easy to integrate in your simulation platform.



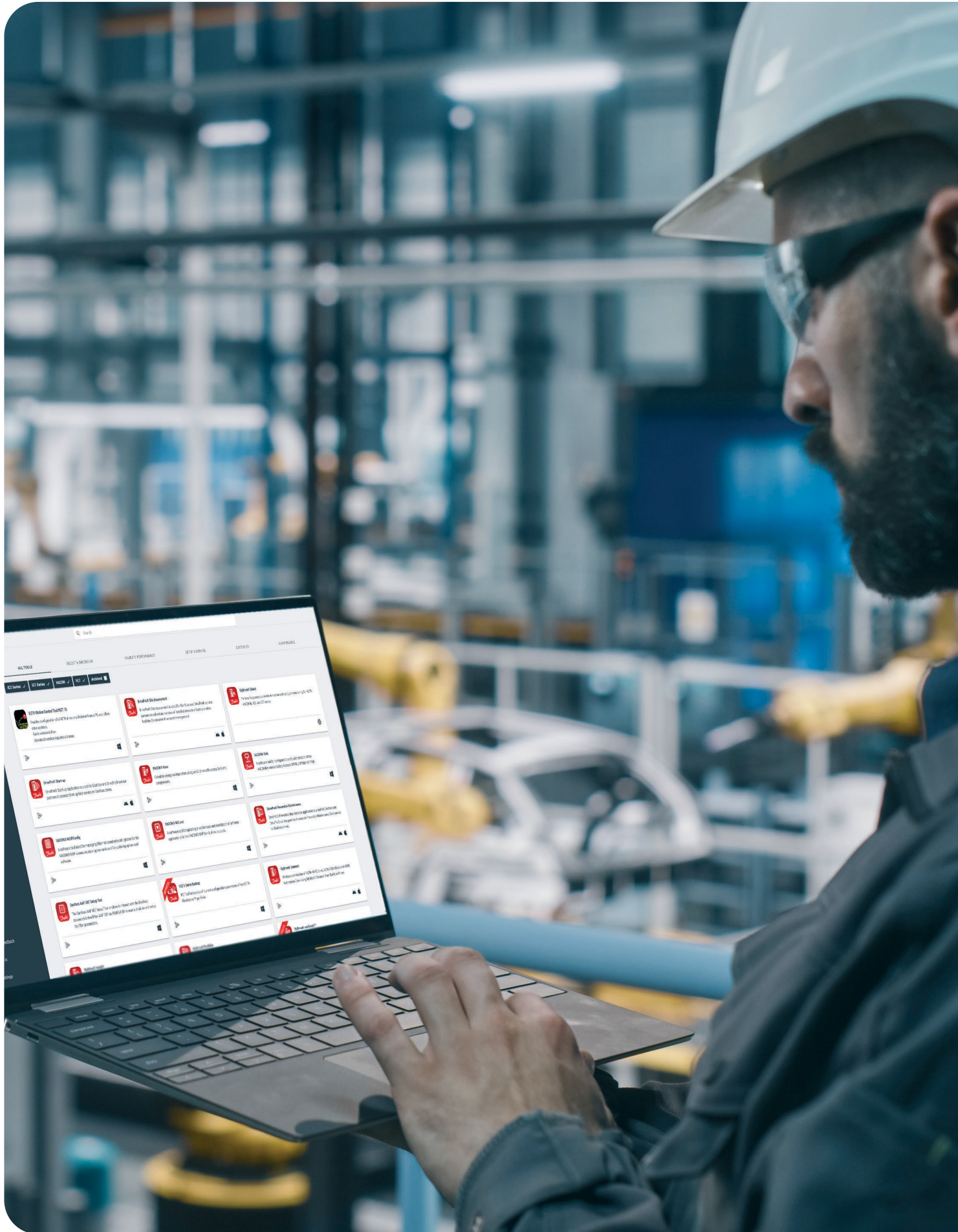



DrivePro[®] Services

Delivering a customized service experience!



Every VFD application is different. DrivePro[®] Services is a collection of tailor-made products designed around your needs.

From optimized spare part packages to condition monitoring solutions, we deliver customized service offerings to support your business through the different lifecycle stages of your drive.



DrivePro® 360Live

Achieve excellence with precision of maintenance. An installed base management solution to register and effectively optimize drives maintenance.



DrivePro® Extended Warranty

Even the best performing AC drives need protection. DrivePro® Extended Warranty offers a wide range of warranty options and provides the longest coverage in the industry up to 72 months.



DrivePro® Site Assessment

Optimize your maintenance strategy with a complete onsite survey and risk analysis of all your AC drives collected in one detailed report. Together with a Danfoss expert, you can build a tailored plan for future maintenance, retrofits, and upgrades.



DrivePro® Start-up

DrivePro® Start-up includes a full range of operating health checks and parameters adjustments. Based on a manufacturer's commissioning checklist, our experts will inspect and test your AC drive and its motor performance to ensure the best configuration of your AC drives.



DrivePro® Spare Parts

Maximize uptime and maintain peak performance throughout the lifetime of your AC drives with DrivePro® Spare Parts by making sure you are equipped with the original spare parts from Danfoss Drives.



DrivePro® Exchange

Maintain uptime with a fast alternative to repair when there is a time critical situation. If an AC drive fails, the DrivePro® Exchange service can quickly exchange any AC drive to a new unit of the same type to ensure as little production delay as possible.

To learn which products are available in your region, please reach out to your local Danfoss Drives sales office or visit our website.



Read more about DrivePro®



Local contacts

Key specifications

Input	
Supply voltage	380-480 V AC, -15%/+10%
Supply frequency	45-65 Hz
Output	
Power range	1.1-710 kW (1.5-950 hp)
Output current	3.0-1260 A
Overload ratings	110% (fans, pumps and compressors), 150% (compressors with high starting torque)
Output frequency	0-590 Hz
Environmental conditions	
Protection ratings and cooling versions	
- Frames Fx02-Fx08 1.1-90 kW (400 V supply)	IP20 (UL Open Type), IP21 (UL Type 1), IP55 (UL Type 12)
- Frames Fx09-Fx12 110-710 kW (400 V supply)	IP20 (UL Open Type), IP21 (UL Type 1), IP54 (UL Type 12), back-channel cooling
Ambient operating temperature ¹⁾	-30 to 60 °C (-22 to 140 °F) <i>Refer to design guide for derating</i>
Maximum altitude	4400 m (14400 feet)
Relative humidity	3K22, maximum 95% non-condensing
Chemically active substances (IEC 60721-3-3:2019)	- C3 (P1) - Medium corrosivity - Non coated - C4 (P2) - High corrosivity - Coated
Shock & vibration (IEC 60721-3-3:2019)	3M12
Harmonic mitigation and THDi	
iC7-HVACR	THDi <40% at full load as per IEC61000-3-12
iC7-HVACR ULH	THDi <3% at full load and <5% at part load

EMC protection (EN/IEC 61800-3 compliance class) ²⁾	Cable length ³⁾
C1	Up to 50 m
C2	Up to 150 m
C3	Up to 300 m
Compliance	
Efficiency class	IE2 as per IEC 61800-9-2. See EcoDesign Directive for a full list of losses at your desired operating point. MyDrive® Energy tool also provides part-load efficiency data.
Approvals	UL 61800-5-1 ed 3. CE IEC61800-5-1. For other approvals, contact Danfoss
Functional safety I/O	
STO	SIL3, PL e
Control I/O – standard	
Analog inputs (AI)	2
- Voltage mode	0-10 V, scalable
- Current mode	0/4-20 mA
- Temperature sensor support	Pt1000, Ni1000, KTY81, KTY82, KTY84
Analog outputs (AO)	1 (0/4-20 mA)
Digital inputs (DI)	4+2 (0/24V, selectable PNP or NPN)
Digital outputs (DO)	2 (0/24 V) Digital outputs are reconfigured from digital inputs
Relay outputs (RO)	2 (NO/NC), 250 V AC/2 A, 24 V DC/2A
Auxiliary voltages	10 V output (10 mA), 24 V output (150 mA)
External supply	24 V external supply input (2 A)

¹⁾ Rated operating temperature varies between products

²⁾ Compliance classes:

C1: Intended for residential, commercial and light industrial installations, and critical installations such as airports, hospitals and data centers

C2: For commercial installations, only when installed by professionals

C3: For industrial installations

³⁾ Cable length varies with product size

Key specifications (continued)

Power options	
Mains input variants	Mains switch, AC fuses
Output filters (external)	dU/dt filters, sine-wave filters
Functional extension options	
General Purpose I/O OC7C0	General purpose I/O extension board (3xDI, 2xDO, 2xAI, 1xAO, temperature measurement)
Relay Option OC7R0	Relay I/O extension board, with 3 relays (2 NO/NC, 1 NO up to 250 V AC/2 A)
Temperature Measurement OC7T0	Temperature measurement extension board with 5 sensor inputs, Pt100, Pt1000, Ni1000, and KTY81
Temperature & Analog I/O OC7T2	Temperature measurement and analog I/O extension board (3 x AI, 3 x AO, 3 temperature sensor inputs)
Fieldbus options (embedded)	
Ethernet control board	Modbus TCP, BACnet IP, EtherNet/IP, PROFINET RT/S2, EtherCAT
Serial control board	Modbus RTU, BACnet MSTP
Other protocols	MQTT
Ease-of-use	
Control panel	
- Display	2.8" graphical, 9 line, greyscale, high resolution
- Buttons	"Back", "on-board manual", rem/loc (HOA) etc. Tactile feedback buttons for operation, local/remote control (HOA) and easy navigation

Commissioning	Guided setup and setup assistant
Parameter backup and restore	
Event log	Clear fault and warning messages
Commissioning tools	MyDrive® Insight*
Engineering tools	MyDrive® Harmonics, MyDrive® Select, MyDrive® Energy
Easy power cable connection	Terminal sliders for 30-90 kW units. Pluggable terminals for IP20 units up to 22 kW.

Dedicated HVAC features

Fire mode protection	Basic and advanced fire mode protection
Cooling tower optimization	Algorithm built-in
Enthalpy	Wet bulb temp and dew point conversion
PID loops	4
Condition-based monitoring	Stator windings, load envelope, vibration monitoring
Power and energy monitoring	kWh counter, RunHours, kW

EMC category (model code)	Frame	EN/IEC 61800-3 compliance class					
		Conducted emission			Radiated emission		
		C1	C2	C3	C1	C2	C3
Combined C1 and C2 filter	Fx02-Fx08	50 (164)	150 (492)	150 (492)	No	Yes	Yes
	Fx02-Fx08	-	150 (492)	150 (492)	No	Yes	Yes
C2 filter	Fx09-Fx12	-	150 (492)	150 (492)	No	Yes	Yes
	Fx02-Fx05	-	-	250 (820)	No	No	Yes
C3 filter	Fx06-Fx08	-	-	300 (984)	No	No	Yes
	Fx09-Fx12	-	-	150 (492)	No	No	Yes

For information on functional extension option slots, go to page 34

Connection diagrams

The numbers represent the terminals on the drive

The drive is built around a power unit, a control unit, and optional I/O options.
The exact configuration depends on the drive model.

Standard control board

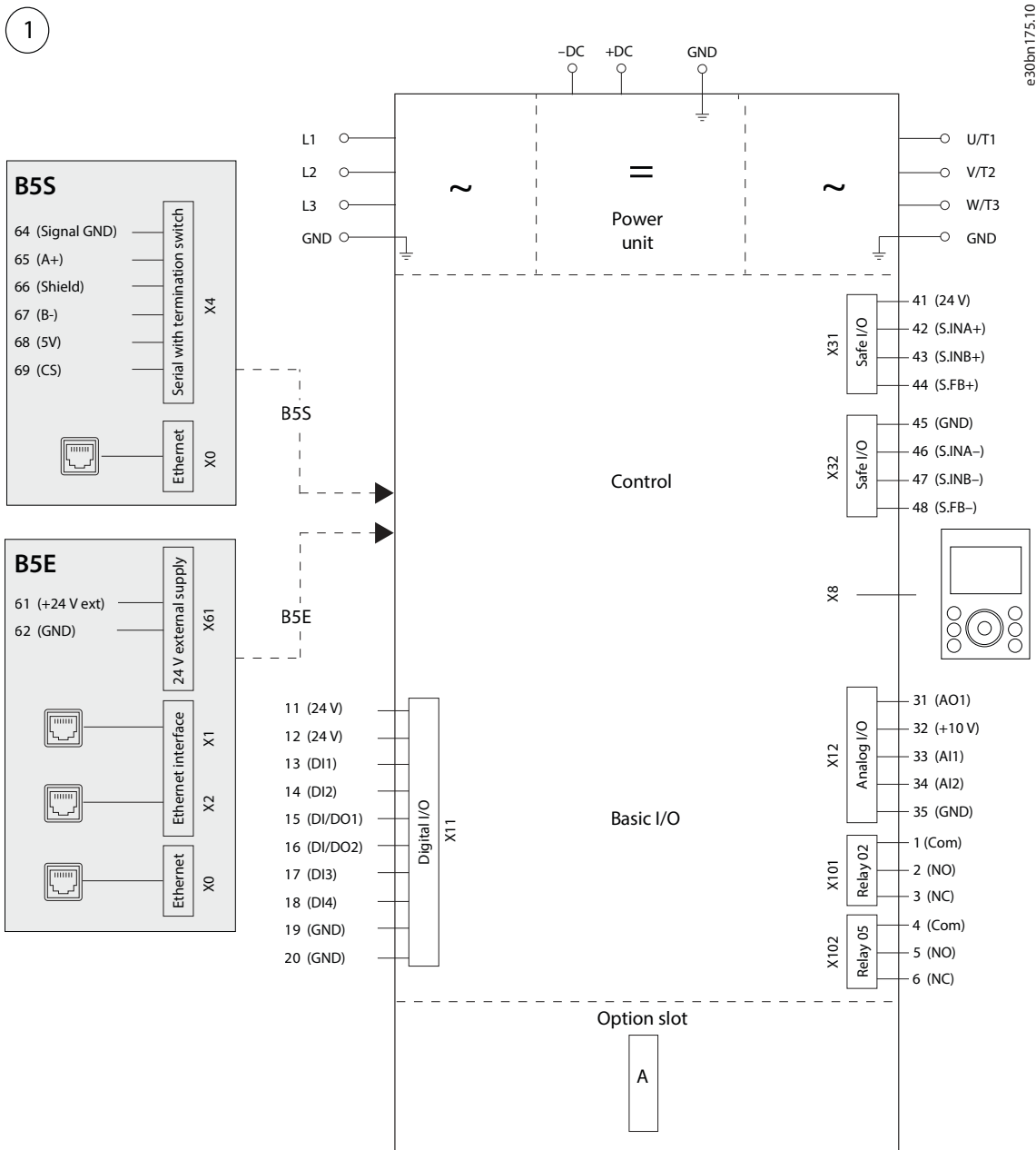

Drive selection made easy



How to configure your drive for HVACR applications

Thousands of drive variants are available. To configure your drive, you make a series of choices to define the model code. Each model code defines a unique variant with a unique ordering number. To simplify the configuration process, follow this guide for the most commonly used variants.

Follow these steps:



- A** Check the model code overview , then select:
 1. Product type: standard or ultra low-harmonic
 2. Voltage rating
 3. Nominal motor current
 4. Ingress protection rating
 5. EMC class required
 6. Optional power hardware
 7. Control board features
 8. Control options, if required

- B** For standard drives running at ambient temperatures of 40°C and 110% overload, use the Quick selection table that matches your supply voltage rating:



- Quick selection – IP20/UL Open Type 400 V @ 110 % overload 
- Quick selection – IP21/UL Type 1 400 V @ 110 % overload 
- Quick selection – IP54/IP55/UL Type 12 400 V @ 110 % overload 

In the quick selection table, find the drive variant you need based on

- Power and current rating
- Enclosure type
- EMC compliance required

- C** For high overload (150%), refer to the ratings tables:
 - Ratings iC7-HVACR 
 - Ratings iC7-HVACR ULH 

- D** Select options, if required. Check the range of hardware extensions and functional extension available for your drive:

- Hardware extensions 
- Functional extensions 

Model code overview



Basic selection

- 1 Product type**
 3N Standard frequency converter
 3H Ultra low-harmonic frequency converter
- 2 Voltage rating**
 02 200-240 V
 04 380-480 V
 07 525-690 V
- 3 Nominal current rating**
 Standard FC 380-480 V – page 27
 ULH FC 380-480 V – page 29
- 4 Protection rating (IP class)**
- 5 EMC category**

Optional selections

- 6 Optional power hardware (+Axxx) – page 32**
- 7 Control board features (+Bxxx) – page 33**
- 8 Functional extension options (+Cxxx) – page 33**
- +DAHR – HVACR dedicated applications**

Quick selection iC7-HVACR IP20/UL Open Type

Model code	Output rating 400 V		Output rating 460 V		Enclosure IP20/UL Open Type		
	Current	Typical power	Current	Typical power	Frame	Weight kg (lb)	W x H x D mm (in)
	[A]	[kW]	[A]	[hp]			
iC7-30FA3N04-03A0E20Fx	3.0	1.1	2.7	1.5	FA02a	4.7 (10.4)	90 x 270 x 221 (3.5 x 10.6 x 8.7)
iC7-30FA3N04-04A0E20Fx	4.0	1.5	3.4	2			
iC7-30FA3N04-05A6E20Fx	5.6	2.2	4.8	3			
iC7-30FA3N04-07A2E20Fx	7.2	3.0	6.3	4			
iC7-30FA3N04-09A2E20Fx	9.2	4.0	8.2	5			
iC7-30FA3N04-12A5E20Fx	12.5	5.5	11.0	7.5			
iC7-30FA3N04-16A0E20Fx	16	7.5	14.5	10			
iC7-30FA3N04-24A0E20Fx	24	11	21	15			
iC7-30FA3N04-31A0E20Fx	31	15	27	20			
iC7-30FA3N04-38A0E20Fx	38	18.5	34	25			
iC7-30FA3N04-43A0E20Fx	43	22	40	30	FA05a	14.1 (31.1)	165 x 399 x 269 (6.5 x 15.7 x 10.6)
iC7-30FA3N04-61A0E20Fx	61	30	55	40	FA06	26 (57)	200 x 555 x 294 (7.9 x 21.9 x 11.6)
iC7-30FA3N04-73A0E20Fx	73	37	66	50	FA07	38 (84)	230 x 600 x 308 (9.1 x 23.6 x 12.1)
iC7-30FA3N04-90A0E20Fx	90	45	81	60			
iC7-30FA3N04-106AE20Fx	106	55	96	75	FA08	55 (121)	255 x 743 x 368 (10 x 29.3 x 14.5)
iC7-30FA3N04-147AE20Fx	147	75	133	100			
iC7-30FA3N04-170AE20Fx	170	90	156	125	FA09	81 (179)	250 x 889 x 370 (9.8 x 35 x 14.6)
iC7-30FA3N04-206AE20Fx	206	110	196	150			
iC7-30FA3N04-245AE20Fx	245	132	240	200			
iC7-30FA3N04-302AE20Fx	302	160	302	250	FA10	127 (280)	350 x 1096 x 370 (13.8 x 43.1 x 14.6)
iC7-30FA3N04-385AE20Fx	385	200	364	300			
iC7-30FA3N04-395AE20Fx	395	200	364	300	FA11	225 (496)	508 x 1578 x 482 (20 x 62.1 x 19)
iC7-30FA3N04-480AE20Fx	480	250	456	350			
iC7-30FA3N04-588AE20Fx	588	315	520	450			
iC7-30FA3N04-658AE20Fx	658	355	590	500	FA12	298 (654)	604 x 1578 x 482
iC7-30FA3N04-736AE20Fx	736	400	658	550			
iC7-30FA3N04-799AE20Fx	799	450	730	600			
iC7-30FA3N04-893AE20Fx	893	500	784	650			
iC7-30FA3N04-1000E20Fx	1000	560	896	750			
iC7-30FA3N04-1120E20Fx	1120	630	1028	850			
iC7-30FA3N04-1260E20Fx	1260	710	1150	950			

Standard I/O and control panel. Pre-selected configurations see table page 34:

Model code refers to the first 22 characters of the model code defining the drive. "x" defines the selected EMC Filter level

Cable length for EN/IEC 61800-3 compliance – conducted emission

	F1	F2	F3
FA02a			
FA04a			C3: 300 m
FA05a	C1: 50 m C2: 150 m C3: 300 m	C2: 150 m C3: 300 m	
FA06			
FA07			C3: 300 m
FA08			
FA09			
FA10			
FA11	N/A	C2: 150 m C3: 300 m	C3: 300 m
FA12			

Quick selection iC7-HVACR IP21/UL Type 1

Model code	Output rating 400 V		Output rating 460 V		Enclosure IP21/UL Type 1		
	Current	Typical power	Current	Typical power	Frame	Weight kg (lb)	W x H x D mm (in)
	[A]	[kW]	[A]	[hp]			
iC7-30FA3N04-03A0E21Fx	3.0	1.1	2.7	1.5	FK03	9.0 (19.8)	189 x 504 x 196 (7.4 x 19.8 x 7.7)
iC7-30FA3N04-04A0E21Fx	4.0	1.5	3.4	2			
iC7-30FA3N04-05A6E21Fx	5.6	2.2	4.8	3			
iC7-30FA3N04-07A2E21Fx	7.2	3.0	6.3	4			
iC7-30FA3N04-09A2E21Fx	9.2	4.0	8.2	5			
iC7-30FA3N04-12A5E21Fx	12.5	5.5	11.0	7.5			
iC7-30FA3N04-16A0E21Fx	16	7.5	14.5	10			
iC7-30FA3N04-24A0E21Fx	24	11	21	15			
iC7-30FA3N04-31A0E21Fx	31	15	27	20			
iC7-30FA3N04-38A0E21Fx	38	18.5	34	25	FK05	14.1 (31.1)	218 x 598 x 228 (8.6 x 23.5 x 9.0)
iC7-30FA3N04-43A0E21Fx	43	22	40	30	FK06	28 (61)	209 x 671 x 303 (8.2 x 26.4 x 11.9)
iC7-30FA3N04-61A0E21Fx	61	30	55	40			
iC7-30FA3N04-73A0E21Fx	73	37	66	50	FK07	38 (84)	239 x 770 x 327 (9.4 x 30.3 x 12.9)
iC7-30FA3N04-90A0E21Fx	90	45	81	60			
iC7-30FA3N04-106AE21Fx	106	55	96	75	FK08	62 (137)	267 x 980 x 367 (10.5 x 38.6 x 14.4)
iC7-30FA3N04-147AE21Fx	147	75	133	100			
iC7-30FA3N04-170AE21Fx	170	90	156	125	FK09a	89 (196)	327 x 999 x 378 (12.9 x 39.3 x 14.9)
iC7-30FA3N04-206AE21Fx	206	110	196	150			
iC7-30FA3N04-245AE21Fx	245	132	240	200			
iC7-30FA3N04-302AE21Fx	302	160	302	250	FK10a	139 (306)	422 x 1230 x 378 (16.6 x 48.5 x 14.9)
iC7-30FA3N04-385AE21Fx	385	200	364	300			
iC7-30FA3N04-395AE21Fx	395	200	364	300			
iC7-30FA3N04-480AE21Fx	480	250	456	350	FK11	244 (538)	602 x 2043 x 510 (23.7 x 80.4 x 20.1)
iC7-30FA3N04-588AE21Fx	588	315	520	450			
iC7-30FA3N04-658AE21Fx	658	355	590	500			
iC7-30FA3N04-736AE21Fx	736	400	658	550	FK12	327 (721)	698 x 2043 x 510 (27.5 x 80.4 x 20.1)
iC7-30FA3N04-799AE21Fx	799	450	730	600			
iC7-30FA3N04-893AE21Fx	893	500	784	650			
iC7-30FA3N04-1000E21Fx	1000	560	896	750			
iC7-30FA3N04-1120E21Fx	1120	630	1028	850			
iC7-30FA3N04-1260E21Fx	1260	710	1150	950			

Standard I/O and control panel. Pre-selected configurations see table page 34

Quick selection iC7-HVACR IP54/IP55/UL Type 12

Model code	Output rating 400 V		Output rating 460 V		Enclosure IP 54/IP55/UL Type 12		
	Current	Typical power	Current	Typical power	Frame	Weight kg (lb)	W x H x D mm (in)
	[A]	[kW]	[A]	[hp]			
iC7-30FA3N04-03A0E55Fx	3.0	1.1	2.7	1.5	FB03	9.0 (19.8)	189 x 504 x 196 (7.4 x 19.8 x 7.7)
iC7-30FA3N04-04A0E55Fx	4.0	1.5	3.4	2			
iC7-30FA3N04-05A6E55Fx	5.6	2.2	4.8	3			
iC7-30FA3N04-07A2E55Fx	7.2	3.0	6.3	4			
iC7-30FA3N04-09A2E55Fx	9.2	4.0	8.2	5			
iC7-30FA3N04-12A5E55Fx	12.5	5.5	11.0	7.5			
iC7-30FA3N04-16A0E55Fx	16	7.5	14.5	10			
iC7-30FA3N04-24A0E55Fx	24	11	21	15			
iC7-30FA3N04-31A0E55Fx	31	15	27	20			
iC7-30FA3N04-38A0E55Fx	38	18.5	34	25	FB05	14.1 (31.1)	218 x 598 x 228 (8.6 x 23.5 x 9.0)
iC7-30FA3N04-43A0E55Fx	43	22	40	30	FB06	28 (61)	209 x 671 x 303 (8.2 x 26.4 x 1.9)
iC7-30FA3N04-61A0E55Fx	61	30	55	40			
iC7-30FA3N04-73A0E55Fx	73	37	66	50	FB07	38 (84)	239 x 770 x 327 (9.4 x 30.3 x 12.9)
iC7-30FA3N04-90A0E55Fx	90	45	81	60			
iC7-30FA3N04-106AE55Fx	106	55	96	75	FB08	62 (137)	267 x 980 x 367 (10.5 x 38.6 x 14.4)
iC7-30FA3N04-147AE55Fx	147	75	133	100			
iC7-30FA3N04-170AE55Fx	170	90	156	125	FB09a	89 (196)	327 x 999 x 378 (12.9 x 39.3 x 14.9)
iC7-30FA3N04-206AE54Fx	206	110	196	150			
iC7-30FA3N04-245AE54Fx	245	132	240	200			
iC7-30FA3N04-302AE54Fx	302	160	302	250			
iC7-30FA3N04-385AE54Fx	385	200	364	300			
iC7-30FA3N04-395AE54Fx	395	200	364	300			
iC7-30FA3N04-480AE54Fx	480	250	456	350			
iC7-30FA3N04-588AE54Fx	588	315	520	450			
iC7-30FA3N04-658AE54Fx	658	355	590	500			
iC7-30FA3N04-736AE54Fx	736	400	658	550	FB10a	139 (306)	422 x 1230 x 378 (16.6 x 48.5 x 14.9)
iC7-30FA3N04-799AE54Fx	799	450	730	600			
iC7-30FA3N04-893AE54Fx	893	500	784	650	FB11	244 (538)	602 x 2043 x 510 (23.7 x 80.4 x 20.1)
iC7-30FA3N04-1000E54Fx	1000	560	896	750			
iC7-30FA3N04-1120E54Fx	1120	630	1028	850			
iC7-30FA3N04-1260E54Fx	1260	710	1150	950	FB12	327 (721)	698 x 2043 x 510 (27.5 x 80.4 x 20.1)

Standard I/O and control panel. Pre-selected configurations see table page 34

Ratings iC7-HVACR

Model code	Rated output current ^{1) 2) 3)}								Frame		
	400 V				460 V				IP20	IP21	IP54/55
	I _{Lo} [A]	Power [kW]	I _{Ho} [A]	Power [kW]	I _{Lo} [A]	Power [HP]	I _{Ho} [A]	Power [HP]			
03A0	3.0	1.1	2.4	0.75	2.7	1.5	2.1	1	FA02	FK03	FB03
04A0	4.0	1.5	3.0	1.1	3.4	2	2.7	1.5			
05A6	5.6	2.2	4.0	1.5	4.8	3	3.4	2			
07A2	7.2	3.0	5.6	2.2	6.3	4	4.8	3			
09A2	9.2	4.0	7.2	3.0	8.2	5	6.3	4			
12A5	12.5	5.5	9.2	4.0	11.0	7.5	8.2	5			
16A0	16	7.5	12.5	5.5	14.5	10	11.0	7.5			
24A0	24	11	16	7.5	21	15	14.5	10			
31A0	31	15	24	11	27	20	21	15			
38A0	38	18.5	31	15	34	25	27	20			
43A0	43	22	38	18.5	40	30	34	25			
61A0	61	30	46	22	55	40	40	30			
73A0	73	37	61	30	66	50	55	40			
90A0	90	45	73	37	81	60	66	50			
106A	106	55	90	45	96	75	81	60			
147A	147	75	106	55	133	100	96	75			
170A	170	90	147	75	156	125	133	100			
206A	206	110	170	90	196	150	166	125			
245A	245	132	206	110	240	200	196	150			
302A	302	160	245	132	302	250	240	200			
385A	385	200	302	160	364	300	302	250			
395A	395	200	302	200	364	300	302	300			
480A	480	250	385	200	456	350	364	300			
588A	588	315	480	250	520	450	456	350			
658A	658	355	588	315	590	500	520	450			
736A	736	400	658	355	658	550	590	500			
799A	799	450	695	400	730	600	653	550			
893A	893	500	799	450	784	650	700	600			
1000	1000	560	880	500	896	750	784	650			
1120	1120	630	1000	560	1028	850	896	750			
1260	1260	710	1100	630	1150	950	1028	850			
									FA04	FK05	FB05
									FA05		
									FA06	FK06	FB06
									FA07	FK07	FB07
									FA08	FK08	FB08
									FA09	FK09	FB09
									FA10	FK10	FB10
									FA11	FK11	FB11
									FA12	FK12	FB12

¹⁾ I_{Lo}: Low overload current. Rated continuous output current with 110% overload capacity – 1 min every 10 min

²⁾ I_{Ho}: High overload current. Rated continuous output current with 150/160% overload capacity – 1 min every 10 min

³⁾ Power values are based on a typical 4-pole induction motor

Quick selection iC7-HVACR ULH IP20/UL Open Type

Model code	Output rating 400 V		Output rating 460 V		Enclosure IP20/UL Open Type		
	Current	Typical power	Current	Typical power	Frame	Weight kg (lb)	W x H x D mm (in)
	[A]	[kW]	[A]	[hp]			
iC7-30FA3H04-147AE20F2	147	75	133	100	FA10b	155 (342)	350 x 1183 x 500 (13.8 x 46.6 x 19.7)
iC7-30FA3H04-170AE20F2	170	90	156	125			
iC7-30FA3H04-206AE20F2	206	110	196	150			
iC7-30FA3H04-245AE20F2	245	132	240	200			
iC7-30FA3H04-302AE20F2	302	160	302	250			

Standard I/O and control panel. Pre-selected configurations see table page 11

Quick selection iC7-HVACR ULH IP21/UL Type 1

Model code	Output rating 400 V		Output rating 460 V		Enclosure IP21/UL Type 1		
	Current	Typical power	Current	Typical power	Frame	Weight kg (lb)	W x H x D mm (in)
	[A]	[kW]	[A]	[hp]			
iC7-30FA3H04-43A0E21F2	43	22	40	30	FK07	37 (82)	239 x 770 x 327 (9.4 x 30.3 x 12.9)
iC7-30FA3H04-61A0E21F2	61	30	55	40			
iC7-30FA3H04-73A0E21F2	73	37	66	50			
iC7-30FA3N04-90A0E21F2	90	45	81	60			
iC7-30FA3H04-106AE21F2	106	55	96	75			
iC7-30FA3H04-147AE21F2	147	75	133	100	FK10b	160 (352.7)	422 x 1239 x 535 (16.6 x 48.8 x 21.1)
iC7-30FA3H04-170AE21F2	170	90	156	125			
iC7-30FA3H04-206AE21F2	206	110	196	150			
iC7-30FA3H04-245AE21F2	245	132	240	200			
iC7-30FA3H04-302AE21F2	302	160	302	250			

Standard I/O and control panel. Pre-selected configurations see table page 11

Quick selection iC7-HVACR ULH IP54/IP55/UL Type 12

Model code	Output rating 400 V		Output rating 460 V		Enclosure IP54/IP55/UL Type 12		
	Current	Typical power	Current	Typical power	Frame	Weight kg (lb)	W x H x D mm (in)
	[A]	[kW]	[A]	[hp]			
iC7-30FA3H04-43A0E55F2	43	22	40	30	FB07	37 (82)	239 x 770 x 327 (9.4 x 30.3 x 12.9)
iC7-30FA3H04-61A0E55F2	61	30	55	40			
iC7-30FA3H04-73A0E55F2	73	37	66	50			
iC7-30FA3N04-90A0E55F2	90	45	81	60			
iC7-30FA3H04-106AE55F2	106	55	96	75			
iC7-30FA3H04-147AE54F2	147	75	133	100	FB10b	160 (352.7)	422 x 1239 x 535 (16.6 x 48.8 x 21.1)
iC7-30FA3H04-170AE54F2	170	90	156	125			
iC7-30FA3H04-206AE54F2	206	110	196	150			
iC7-30FA3H04-245AE54F2	245	132	240	200			
iC7-30FA3H04-302AE54F2	302	160	302	250			

Standard I/O and control panel. Pre-selected configurations see table page 11

Ratings iC7-HVACR ULH, ultra low-harmonic drive

Model code	Rated output current								Frame
	400 V				460 V				
	I_{Lo}	Power	I_{Ho}	Power	I_{Lo}	Power	I_{Ho}	Power	
[A]	[kW]	[A]	[kW]	[A]	[HP]	[A]	[HP]		
43A0	43	22	38	18.5	40	30	34	20	FK07 FB07
61A0	61	30	43	22	55	40	40	30	
73A0	73	37	61	30	66	50	55	40	
90A0	90	45	73	37	81	60	66	50	
106A	106	55	90	45	96	75	81	60	
147A	147	75	106	55	132	100	96	75	
170A	170	90	147	75	166	125	132	100	FA10b FK10b FB10b
206A	206	110	170	90	196	150	166	125	
245A	245	132	206	110	240	200	206	150	
302A	302	160	245	132	295	250	245	200	

I_{Lo} : Low overload current. Rated continuous output current with 110% overload capacity – 1 min every 10 min

I_{Ho} : High overload current. Rated continuous output current with 150/160% overload capacity – 1 min every 10 min



Dimensions and weight

iC7-HVACR standard frequency converter

Protection rating		IP20		IP21/ IP54/55	IP20		IP21/ IP54/55
Frame		FA02a	FA03a	FK03/FB03	FA04a	FA05a	FK05/FB05
[mm]	Width	90	114	189	130	165	74
	Height	270	270	504	399	399	19.8
	Depth	221	221	196	262	269	7.7
[kg]	Weight	4.7	5.7	9	11.6	14.1	19.8
[in]	Width	3.5	4.5	7.4	5.1	6.5	7.4
	Height	10.6	10.6	19.8	15.7	15.7	19.8
	Depth	8.7	8.7	7.7	10.3	10.6	7.7
[lb]	Weight	10.4	12.6	19.8	25.6	31.1	19.8

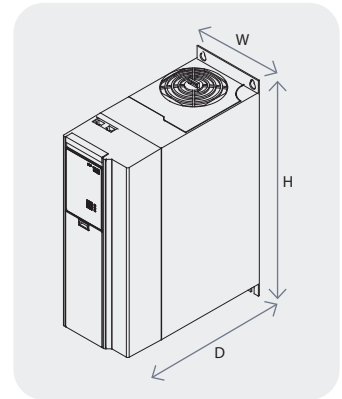

Frames FA02b to FA05b: Add 26 mm (1 in) to depth.
Outer dimensions include mounting flange, without EMC shield plates.
Weight is maximum weight.

Protection rating		IP20	IP21	IP54/55	IP20	IP21	IP54/55	IP21	IP21	IP54/55
Frame		FA06	FK06	FB06	FA07	FK07	FB07	FA08	FK08	FB08
[mm]	Width	200	210	214	230	240	245	255	270	273
	Height	555	670	672	600	770	771	746	980	981
	Depth	294	297	303	308	327	327	368	365	367
[kg]	Weight	26	28	29	35	38	38	55	60	62
[in]	Width	7.9	8.3	8.4	9.1	9.5	9.6	10.0	10.6	10.7
	Height	21.9	26.4	26.5	23.6	30.3	30.4	29.4	38.6	38.6
	Depth	11.6	11.7	11.9	12.1	12.9	12.9	14.0	14.4	14.4
[lb]	Weight	57	61	64	77	83	84	121	132	137

Outer dimensions include mounting flange, without EMC shield plates.
Weight is maximum weight.

Protection rating		IP20	IP21/ IP54/55	IP21/ IP54/55	IP20	IP21/ IP54/55	IP21/ IP54/55	IP20	IP21/ IP54/55	IP20	IP21/ IP54/55
Frame		FA09	FK09a/ FB09a	FK09c/ FB09c	FA10	FK10a/ FB10a	FK10c/ FB10c	FA11	FK11/FB11	FA12	FK12/FB12
[mm]	Width	250	325	325	350	420	420	508	602	604	698
	Height	909	1001	1421	1122	1232	1779	1578	2043	1578	2043
	Depth	370	378	381	370	378	381	482	513	482	513
[kg]	Weight	81	84	107	127	137	174	225	272	298	320
[in]	Width	9.8	12.8	12.8	13.8	16.5	16.5	20	23.7	23.9	698
	Height	35.8	39.4	55.9	44.2	48.5	70.0	62.1	80.4	62.1	2043
	Depth	14.8	14.9	15.0	14.6	14.9	15.0	19.0	20.2	19.0	513
[lb]	Weight	179	184	236	280	302	384	496	600	654	320

Weight is maximum weight.

iC7-HVACR ULH frequency converter

Protection rating		IP20		IP21/IP54/IP55	
Frame		FA10b		FK07/FB07	FK10b/FB10b
[mm/in]	Width	352/13.9		239/9.4	422/16.6
	Height	1186/46.7		770/30.3	1239/48.8
	Depth	505/19.9		327/12.9	535/160
[kg/lbs]	Maximum weight	158/348		38/83	160/352.7

Model code overview: Model code iC7-HVACR and ULH variants

For more detailed information, refer to the iC7-HVACR Design Guide

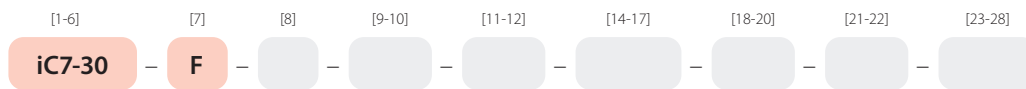

[1-6] Product group (character 1-6)

iC7-30 Indication of product group

[7] Product category (character 7)

F Frequency converter

[8] Cooling method (character 8)

A Air-cooled

[9-10] Product type (character 9-10)

3N Three-phase 6-pulse

3H Three-phase ultra low-harmonic

[11-12] Voltage rating (character 11-12)

05 380-480 V AC

[14-17] Nominal Amp rating ²⁾ (character 14-17)

03A0 3.0 A

04A0 4.0 A

05A6 5.6 A

07A2 7.2 A

09A2 9.2 A

12A5 12.5 A

16A0 16 A

24A0 24 A

31A0 31 A

38A0 38 A

43A0 43 A

61A0 61 A

73A0 73 A

90A0 90 A

106A 106 A

147A 147 A

170A 170 A

206A 206 A

245A 245 A

302A 302 A

385A 385 A

395A 395 A

480A 480 A

588A 588 A

658A 658 A

736A 736 A

799A 799 A

893A 893 A

1000 1000 A

1120 1120 A

1260 1260 A

¹⁾ +codes identifying options

²⁾ See rating tables on pages 9-10

X indicates a standard selection
O indicates an optional selection
 A dash (-) indicates that the selection is not available

[18-20] Protection rating (character 18-20)

E20 IP20/Open Type

E21 IP21/UL Type 1

E54 IP54/UL Type 12

E55 IP55/UL Type 12

[21-22] EMC Class (character 21-22)

F1 C1 and C2 category

F2 C2 category

F3 C3 category

[23-28] +code group

+Axxx Optional power hardware

+Bxxx Control hardware

+Cxxx Functional extension options

+Dxxx Application software and additional functionality

+Exxx Customized settings, for Danfoss use only

+Axxx Optional power hardware IP20

Function	Model code	Selection description	Fx02-05	Fx06-08	Fx09-12
Extra environmental protection	+AGXX	None	X	X	-
	+AGCX	Coated boards	O	O	X
Mains input device	+AJXX	None	X	X	X
	+AJFX	AC fuses	-	-	O
DC terminals	+ALXX	None	-	X	X
	+ALDC	Yes	X	O	O
Heat sink access panel	+APXX	None	X	X	X
	+APHS	Yes	-	-	O

+Axxx Optional power hardware IP21 and IP54/55

Function	Model code	Selection description	Fx02-05	Fx06-08	Fx09-12
Cable entry and EMC plate	+AAST	Standard, no holes	-	X	X
	+AAME	Input plate, metric holes	-	- ¹⁾	-
	+AAIM	Input plate, imperial holes	O	- ¹⁾	-
Extra environmental protection	+AGXX	None	X	X	-
	+AGCX	Coated boards	O	O	X
Humidity protection device	+AHXX	None	X	X	X
	+AHHX	Space heater	-	-	O
Mains input device	+AJXX	None	X	X	X
	+AJFX	AC fuses	O	O	X
	+AJXD	Mains switch	O	O ²⁾	-
	+AJFD	AC fuses and mains switch	- ¹⁾	O ²⁾	O
DC terminals	+ALXX	None	-	X	X
	+ALDC	Yes	X	O ²⁾	O
Touch protection	+AMXX	None	X	X	X
	+AMMX	Yes	-	-	O
Heat sink access panel	+APXX	None	X	X	X
	+APHS	Yes	-	-	O

¹⁾ Pending

²⁾ DC terminals cannot be combined with mains switch

Options availability may differ for the ULH variant. For details, please contact your local Danfoss team

+Bxxx Control board features

Function	Model code	Selection description	Note
Communication interface	+BAMR	Modbus RTU OS7MR	Serial control board
	+BABN	BACnet MSTP OS7BN	Serial control board
	+BAMT	Modbus TCP OS7MT	EtherNet control board
	+BABI	BACnet IP OS7BI	EtherNet control board
	+BAPX	PROFINET RT OS7PR	EtherNet control board
	+BAIX	EtherNet/IP OS7IP	EtherNet control board
	+BAEX	EtherCAT OS7EC	Ethernet control board
Functional safety	+BEG1	Safe Torque Off	
Standard I/O	+BDDBA	Basic I/O (4 x DI, 2 x combined DI/DO, 2 x AI, 1 x AO, 2 x relay)	Integrated in control board
Control panel	+BF00	Blind Panel OPX00	Not available in Fx09-12
	+BF20	Control Panel 2.8 OPX20	

+Cxxx Functional extension options

Control options	Description
+CAX0	None
+CAC0	General Purpose I/O OC7C0
+CAR0	Relay Option OC7R0
+CAT0	Temperature Measurement OC7T0
+CAT2	Temperature & Analog I/O OC7T2

Options

Functional extensions	Description
General Purpose I/O OC7C0	General purpose I/O extension board: 3 digital inputs 2 digital outputs 2 analog inputs 1 analog output
Relay Option OC7R0	Relay I/O extension board, with 3 relays
Temperature Measurement OC7T0	The Temperature Measurement option adds 5 temperature sensor inputs with compensation input. Supported sensors are Pt100, Pt1000, Ni1000, and KTY81
Temperature & Analog I/O OC7T2	Temperature measurement and analog I/O option board 3 analog inputs 3 analog outputs 3 temperature inputs

Fieldbus

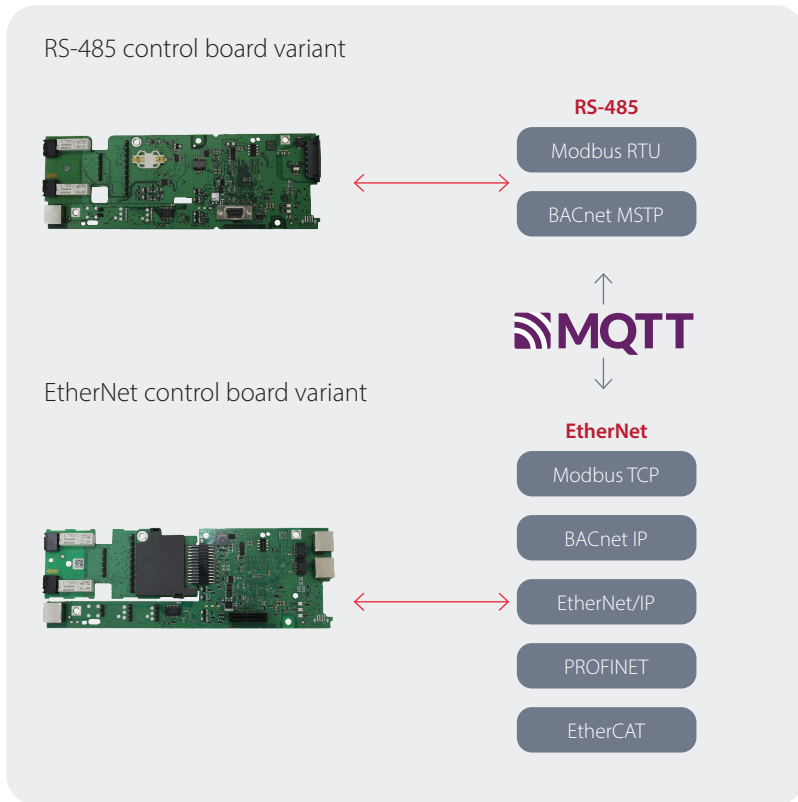





Your ambition. Our drive. Meet iC7 series iC7-Automation | iC7-Marine | iC7-Hybrid | iC7-HVACR | iC7-Aqua

Imagine versatile and highly secure motor control and power conversion. The iC7 series puts this capability securely in your hands. Intensely powerful and compact variable frequency drives and converters built to optimize a vast range of systems, while giving you the flexibility to distribute intelligence the way you want. Paving the way for new ambitions, where intelligent, efficient, and connected systems are the new reality.

Any information, including, but not limited to information on selection of product, its application or use, product design, weight, dimensions, capacity or any other technical data in product manuals, catalogues descriptions, advertisements, etc. and whether made available in writing, orally, electronically, online or via download, shall be considered informative, and is only binding if and to the extent, explicit reference is made in a quotation or order confirmation. Danfoss cannot accept any responsibility for possible errors in catalogues, brochures, videos and other material. Danfoss reserves the right to alter its products without notice. This also applies to products ordered but not delivered provided that such alterations can be made without changes to form, fit or function of the product. All trademarks in this material are property of Danfoss A/S or Danfoss group companies. Danfoss and the Danfoss logo are trademarks of Danfoss A/S. All rights reserved.

Some functionalities listed in this fact sheet are for future implementation

Danfoss Drives A/S
Ulsnaes 1
6300 Graasten
Denmark
CVR reg. no. 19883876

© Danfoss 2026