

UnoFloors

Uno Floor Basic_ Comfort_ Control

Description

The Danfoss UnoFloor series comprises preassembled stainless steel distribution units designed for installation in cabinets, suitable for both in-wall and on-wall applications. These solutions enable installers to conveniently order a ready-made, plug-and-play assembly for the mounting of distribution pipes within a building section. The units are available as standard configurations with 4 to 12 connections and are equipped with a manual air vent and a drain valve. In addition, they include a flow meter to maintain the designated flow rate. The Comfort and Control version is equipped with the AB-PM set, which ensures optimal hydronic balance. Flow limitation, independent of differential pressure, is thereby ensured.

Features & benefits

- Plug-and-play construction for quick and easy installation
- Durable stainless steel distribution unit for long service life
- Compact design requiring minimal installation space
- In-wall cabinet reduces installation time to a minimum
- Pre-mounted components minimise the risk of installation errors
- Accurate heat distribution, even under partial load conditions
- Reliable hydronic balancing for reduced heating costs (Comfort/Control versions)
- App-based solutions available for both installers and end-users (Control version).

Applications

- UnoFloor Basic
- UnoFloor Comfort
- UnoFloor Control



Ordering

Product code numbers

Product code numbers UnoFloor

Distribution unit	Basic	Comfort	Control
2 circuits left version	-	088X3202	-
3 circuits left version	.	088X3203	-
4 circuits left version	088X3104	088X3204	088X3644
5 circuits left version	088X3105	088X3205	088X3645
6 circuits left version	088X3106	088X3206	088X3646
7 circuits left version	088X3107	088X3207	088X3647
8 circuits left version	088X3108	088X3208	088X3648
10 circuits left version	088X3110	088X3210	088X3650
12 circuits left version	088X3112	088X3212	088X3652
2 circuits right version	-	088X3222	-
3 circuits right version	-	088X3223	-
4 circuits right version	088X3124	088X3224	088X3664
5 circuits right version	088X3125	088X3225	088X3665
6 circuits right version	088X3126	088X3226	088X3666
7 circuits right version	088X3127	088X3227	088X3667
8 circuits right version	088X3128	088X3228	088X3668
10 circuits right version	088X3130	088X3230	088X3670
12 circuits right version	088X3132	088X3232	088X3672

On-wall panels

Code number	Description
088X3014	On-wall panels UnoFloor 610 wide (2 - 6 circuits)
088X3016	On-wall panels UnoFloor 760 wide (7 - 8 circuits)
088X3018	On-wall panels UnoFloor 960 wide (10 - 12 circuits)

Spare parts code numbers

Code number	Description
013G7376	Service built-in valve for manifold
088U0819	Replacement flowmeter for FHF & SSM manifold
088H3112	TWA-A, RA , NC, 230V
088U1040	ICON Wiring Center
088U2110	ICON2 Advanced Master Controller
088X3008	Frame and door for UnoFloor cabinet 610
088X3010	Frame and door for UnoFloor cabinet 760
088X3012	Frame and door for UnoFloor cabinet 960





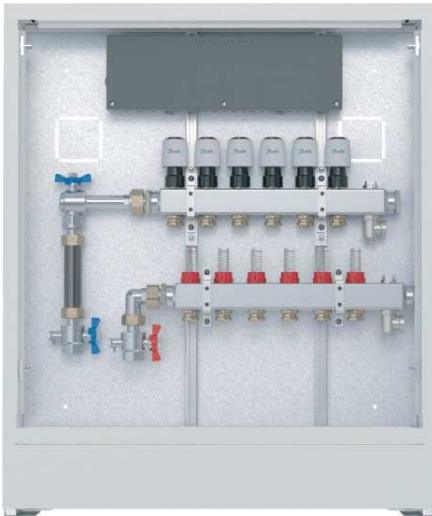

Accessories code numbers

Wired solution – UnoFloor Basic with ICON™ Wiring Center Installed



Basic

Is delivered with flow meter and fitted with an Icon™ Wiring Center 230V and thermoactuators TWA NC for control of the floor heating system. Wired room thermostats.





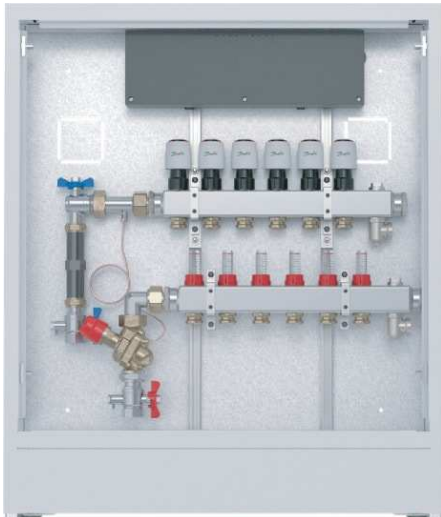

Code number		
088U1000	Danfoss ICON™ Dial, In-wall	
088U1010	Danfoss ICON™ Display, In-wall	
088U1020	Danfoss ICON™ Programable, In-wall	
088U1005	Danfoss ICON™ Dial, On-wall	
088U1015	Danfoss ICON™ Display, On-wall	
088U1025	Danfoss ICON™ Programable, On-wall	
088U1110	Floor sensor	

Wired solution – UnoFloor Comfort with ICON™ Wiring Center Installed



Comfort

Is delivered with flow meter and fitted with an Icon™ Wiring Center 230V and thermoactuators TWA NC for control of the floor heating system. Wired room thermostats. AB-PM set which ensures optimal hydronic balance.

Code number		
088U1000	Danfoss ICON™ Dial, In-wall	
088U1010	Danfoss ICON™ Display, In-wall	
088U1020	Danfoss ICON™ Programable, In-wall	
088U1005	Danfoss ICON™ Dial, On-wall	
088U1015	Danfoss ICON™ Display, On-wall	
088U1025	Danfoss ICON™ Programable, On-wall	
088U1110	Floor sensor	

Wireless/ wired solution – UnoFloor Control with ICON2™ Advanced Master Controller Installed

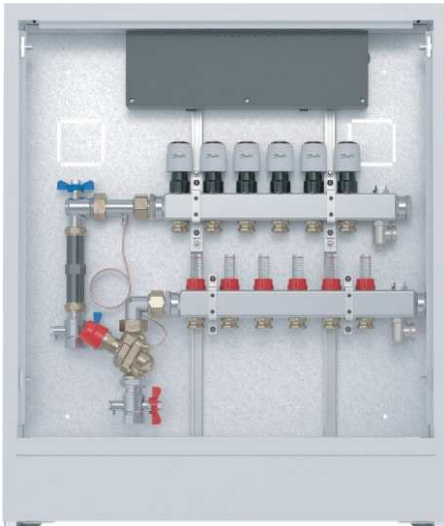







Control

Delivered with a flow meter and fitted with an Icon2™ Advanced Master Controller (230V) and TWA NC thermo-actuators for controlling the floor heating system. Compatible with both wireless and wired room thermostats.

Equipped with an AB-PM set, which ensures optimal hydronic balance.

Includes an app-based installation guide for the installer, with the option to generate an installation report for documentation purposes.

By purchasing a Danfoss Ally™ Gateway, the end-user can control room heating via the Danfoss Ally™ app.

Code number		
088U2121	Danfoss ICON2™ RT display thermostat Wireless	
088U2122	Danfoss ICON2™ Featured RT display thermostat with infrared floor sensor Wireless	
088U2120	Danfoss ICON2™ Sensor, no settings or display Wireless	
088U2128	Danfoss ICON2™ On-wall thermostat 2- wire 24 V	
088U2125	Danfoss ICON2™ In-wall thermostat 2- wire 24 V	
088U1110	Floor sensor	
014G2400	Danfoss Ally™ Gateway (for user-app)	

Product details

General data

Table: Technical data

Q_{max} (at $\Delta p = 20$ kPa)	600 l/h (at 100% setting)
Upper limit of pressure controller at zero flow	35 kPa
Differential pressure (Δp for the valve + circuit)	28 - 400 kPa
Nominal maximal pressure	16 bar (PN 16)
Control valves characteristic	Linear
Shut-off leakage rate	Acc. to ISO 5208 class A - no visible leakage
Medium temperature	-10 °C to 120 °C
CV stroke	2.25 mm
Connection - external thread ISO	G 1 A
Connection - actuator	M30 X 1.5

Dimensions

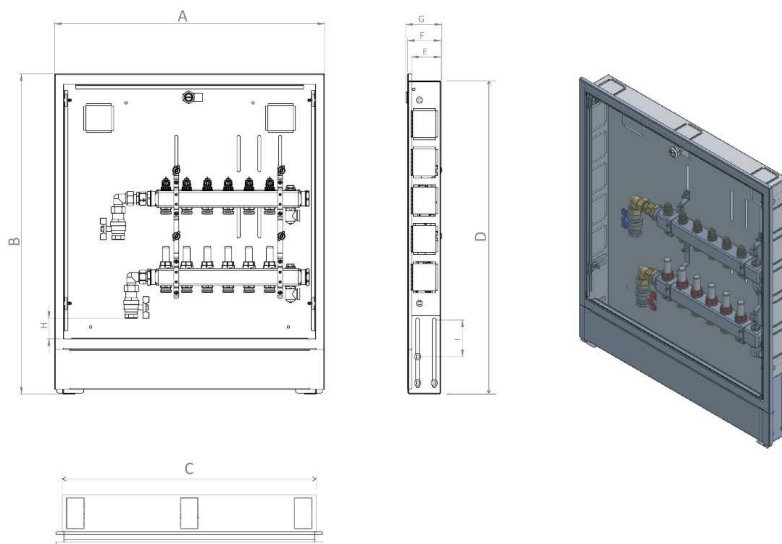

Dimensions [mm]	A	B	C	D	E	F	G	H	I
2 circuits	650	769	619	752	101	111	115	21	88
3 circuits	650	769	619	752	101	111	115	21	88
4 circuits	650	769	619	752	101	111	115	21	88
5 circuits	650	769	619	752	101	111	115	21	88
6 circuits	650	769	619	752	101	111	115	21	88
7 circuits	800	769	769	752	101	111	115	21	88
8 circuits	800	769	769	752	101	111	115	21	88
10 circuits	1000	769	969	752	101	111	115	21	88
12 circuits	1000	769	969	752	101	111	115	21	88

Connections

SSM Floor heating manifold

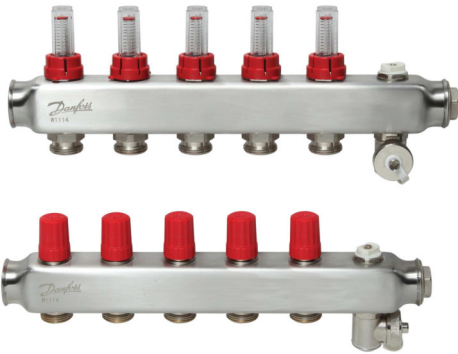

The SSM manifold is used for controlling water flow in underfloor heating system. Each tube of the floor heating system is connected to the manifold, thus making it possible to control water flow or heat supply to each room in the building individually.

Nominal pressure	PN 6
DH supply temperature Tmax	60 °C
Supply voltage	230 V
Output voltage	230 V
Connection sizes	G 3/4" (IT)

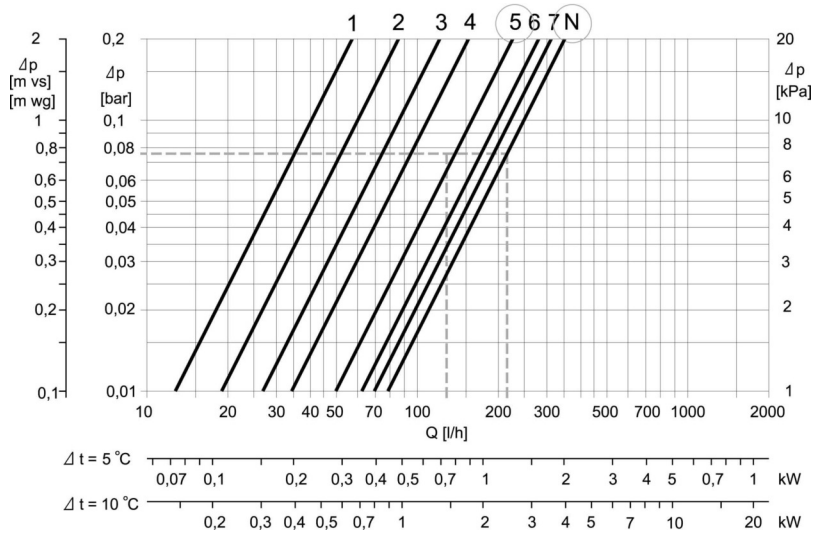

ICON™ Wiring Center (Basic / Comfort)



Danfoss ICON™ Wiring Center is a connection box for use in hydronic floor heating using 230 V thermostats and actuators.

Can connect up to 14 thermal actuators from up to 8 room thermostats. It is provided with 230 V circulation pump output and voltage-free relays for controlling a boiler. The relays are activated when one or more thermostats require heat.

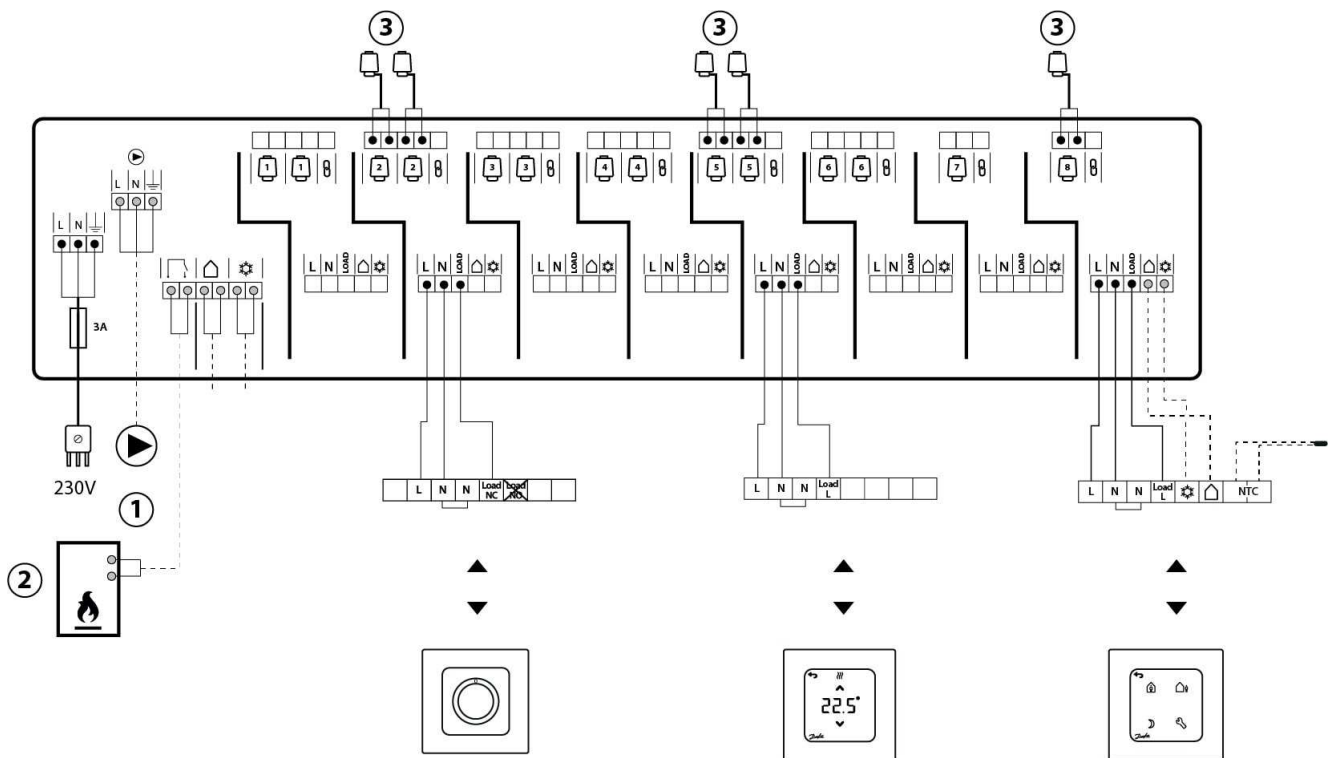

1. Circulation pump
2. Heat signal (potential free)
3. 230V thermal actuator, NC

Note: It is possible to connect up to 8 room thermostats. This means that with 10 and 12 circuits, one or two room thermostats must control two circuits each.

The TWA's is connected from the factory, see how on the next page. But it will be possible to change the connections afterwards.

Actuator wiring LEFT variant

The actuators are wired to respective terminals on the Wiring Center as below. Actuators and cables will be marked accordingly.

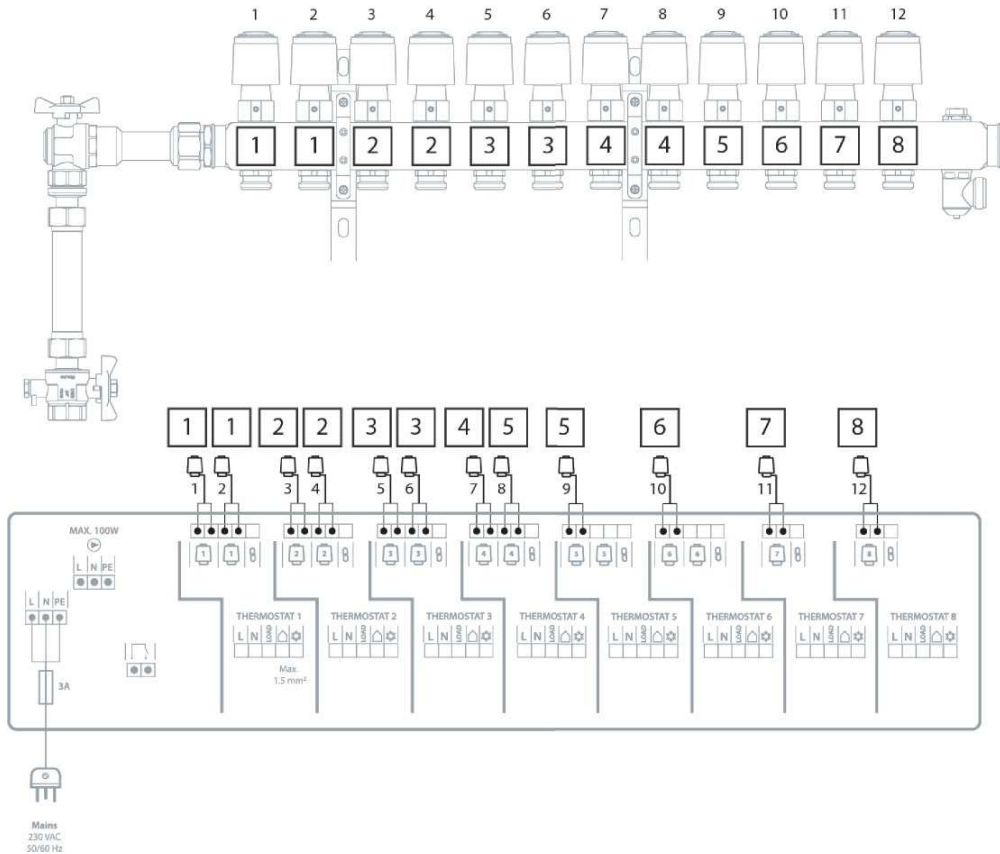
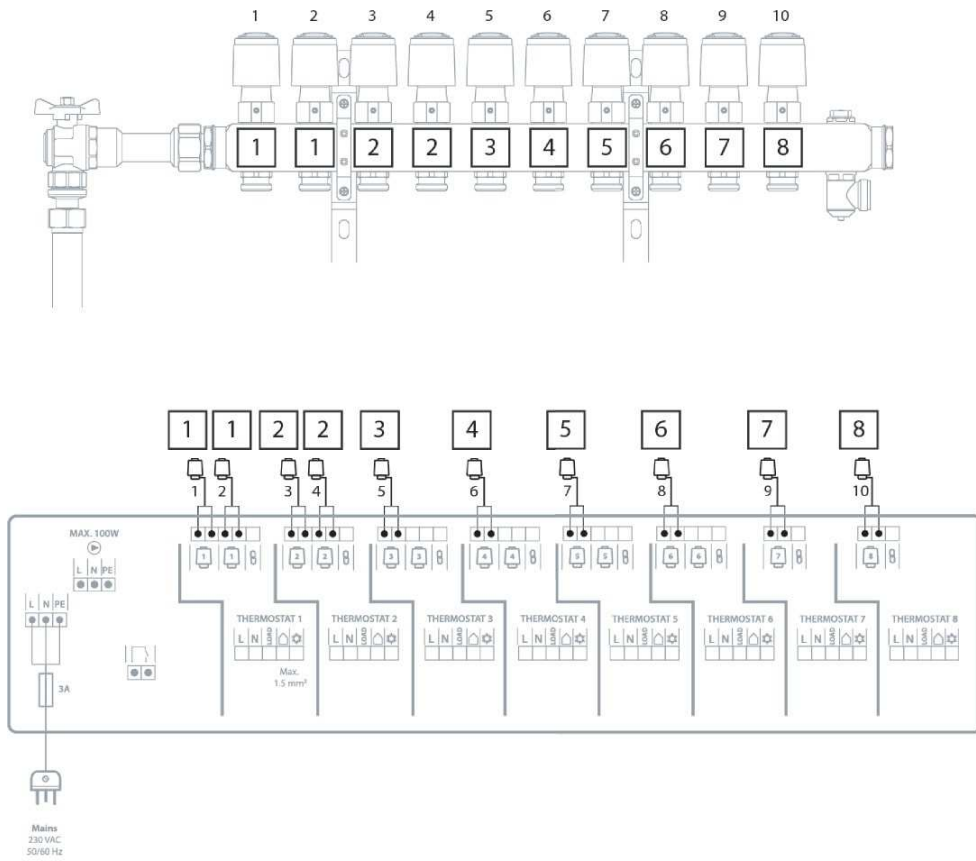

ICON2™ Advanced Master Controller (Control)



Danfoss ICON2™ Advanced Master Controller is a control box for use in hydronic floor heating using wireless or wired thermostats and 230 V actuators.

- Automatic balancing (PWM+), which ensure that hydraulic balancing of the system is done by the master controller based on the actual room demand.
- Requires no pre-setting on the manifold
- On/Off control possibility
- Possibility to combine wired and wireless thermostats in same installation

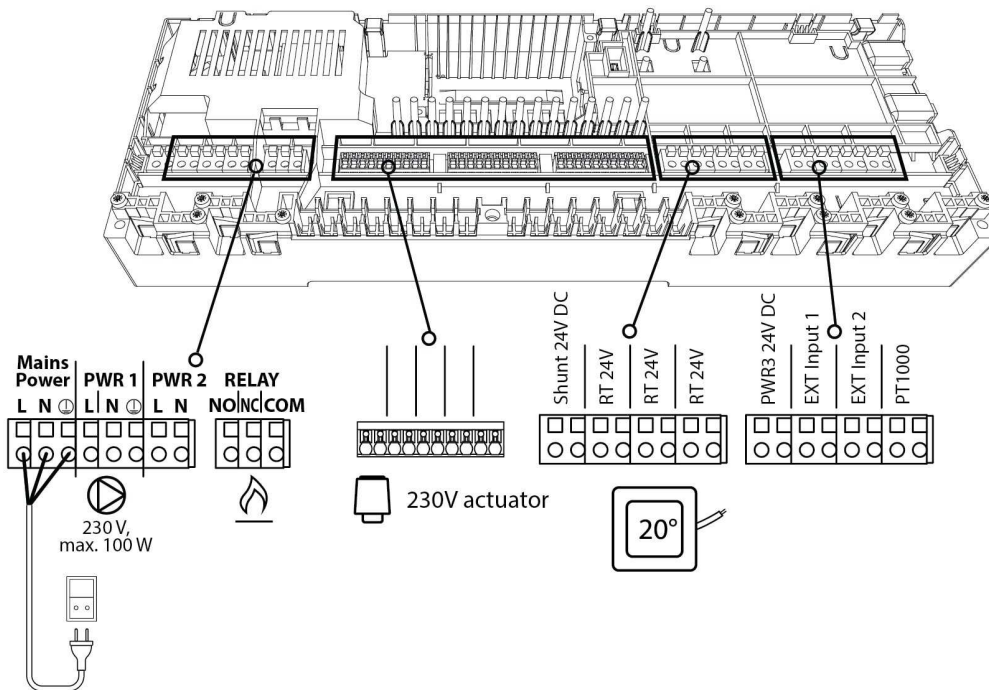

1. Circulation pump
2. Heat signal (potential free)
3. 230 V thermal actuator, NC

AB-PM DN20 (Comfort / Control)

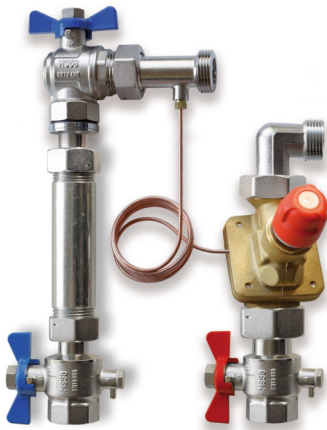

The AB-PM connection set is a compact and time-saving configuration — designed for creating optimal hydraulic balance in horizontal loops — radiator and underfloor heating applications. Flow limitation independent of differential pressure is now guaranteed. It can be combined with most types of manifolds, heat meters and manifold cabinets.

Sizing

AB-PM is to be sized based on manifold's needed flow (Q) [l/h], and needed differential pressure drop for the loop (pr). Max AB-PM flow data are presented in the table below.

For any other Q and pr needed, AB-PM size and setting can be indicated.

Type	DN 20 HP at 100% setting	
Q _{max}	600 l/h	915 l/h
Maximum pressure drop available for system at max flow	20 kPa	10 kPa
Upper limit of pressure controller at zero flow	35 kPa	
Start required differential pressure (for the valve)	8 kPa	

Certificates, declarations and approvals

The list contains all certificates, declarations, and approvals for this product type. Individual code number may have some or all of these approvals, and certain local approvals may not appear on the list.

When you click on the link you will be directed to the latest version of the 'Declaration of Conformity'. Products developed and sold before this date of issue conform to the directives/standards in force at the time of their sale.

Approval type	Title	Certification body	Approval topic
EU Declaration	Danfoss EU 240806EN670901	Danfoss	LVD, EMC, EU RoHS
Export Control Declaration	PL67 Export Control Declaration Distribution units UnoFloors - Stainless steel	Danfoss	
Manufacturer's Declaration	Manufacturers Declaration of Compliance with regulation 2023/2854	Danfoss	
EU Declaration	Danfoss EU 240806EN671001.02	Danfoss	EU RoHS, RED
Export Control Declaration	Export Control Declaration - Distribution units, UnoFloors - Telecommunication equipment	Danfoss	

Tender text

UnoFloor Basic

Pre-assembled underfloor heating balancing and control distribution unit must come wired and pre-mounted, suitable for left- or right-hand side connection to the manifold, fitted in in-wall cabinet.

Cabinet must be painted in white (RAL 9016), X mm in height, up to X mm in width and X mm in depth.

It must be possible to connect the room thermostats to the NC actuators via a connection box. The connection box must have not less 8 channels and 14 actuator outputs, have two potential free relays: one for the pump and one for the boiler. Distribution voltage: 230 V AC. Voltage: 230 V AC, max. power per output: 3 W.

The manifold is used for heat regulation in floor heating systems. Each circuit in the floor heating system is connected to the manifold, which makes it possible to regulate the heat supply to each room in the building independently.

The manifold shall consist of a flow and return manifold where the flow manifold must be able to close each circuit independently. The return manifold must be equipped with presetting valves, ensuring optimal balancing of the system. Flow control of the floor heating system shall be done on a visible presetting scale, so that the value can be read and checked after commissioning. Valves shall be controlled electronically by thermal actuators installed without adapters.

The manifold must be provided in modules with air vent and drain / fill function valve.

The manifold must be made of stainless steel and have the following specifications:

- Maximum flow temperature : 90 °C;
- Maximum differential pressure: 0,6 bar;
- Maximum operating pressure: 6 bar;
- Max Kv setting of the valve (N): 0,97 m²/h.

The actuator must be pre-mounted on a valve. The actuator receives a signal from the room thermostat. Based on the signal, it opens and closes the valve which makes it possible to regulate the energy supply to each room in the building independently. For easy and secure installation, the actuator must be delivered as one part (no adapter) and mounted on the manifold by use of an Allen screw.

The heat meter connection set must be suitable for left and right hand side connection to the distributor/ collector. Connection set must include 110 mm length meter spool piece with no reducing 3/4" connection and flat seals. The connection to the manifold is 1" flat sealing.

UnoFloor Comfort

Pre-assembled pressure independent underfloor heating balancing and control distribution unit must come wired and pre-mounted, suitable for left- or right-hand side connection to the manifold, fitted in in-wall cabinet.

Cabinet must be painted in white (RAL 9016), X mm in height, up to X mm in width and X mm in depth.

It must be possible to connect the room thermostats to the NC actuators via a connection box. The connection box must have not less 8 channels and 14 actuator outputs, have two potential free relays: one for the pump and one for the boiler. Distribution voltage: 230 V AC. Voltage: 230 V AC, max. power per output: 3 W

The manifold is used for heat regulation in floor heating systems. Each circuit in the floor heating system is connected to the manifold, which makes it possible to regulate the heat supply to each room in the building independently.

The manifold shall consist of a flow and return manifold where the flow manifold must be able to close each circuit independently. The return manifold must be equipped with presetting valves, ensuring optimal balancing of the system. Flow control of the floor heating system shall be done on a visible presetting scale, so that the value can be read and checked after commissioning. Valves shall be controlled electronically by thermal actuators installed without adapters.

The manifold must be provided in modules with air vent and drain / II function valve.

The manifold must be made of stainless steel and have the following specifications:

- Maximum flow temperature : 90 °C;
- Maximum differential pressure: 0,6 bar;
- Maximum operating pressure: 6 bar;
- Max Kv setting of the valve (N): 0,97 m²/h.

The actuator must be pre-mounted on a valve. The actuator receives a signal from the room thermostat. Based on the signal, it opens and closes the valve which makes it possible to regulate the energy supply to each room in the building independently. For easy and secure installation, the actuator must be delivered as one part (no adapter) and mounted on the manifold by use of an Allen screw.

The pressure independent balancing and control set must consist of a linear control valve, impulse tube with adapters to it, 3-piece ball valve with connection to impulse tube and heat meter, connector to manifold . The valve could be used as an automatic flow limiter. The valve should have a mechanism to adjust the flow from 100 % to 0 % of the maximum flow. Maximum recommended flow setting should not be more than 600 l/h at maximum system pressure drop 10 kPa, and no more than 915 l/h at maximum system pressure drop 5 kPa. Shut off service function should be possible with setting mechanism. The authority of the pressure independent control valve should be 1 at all settings (control valve characteristic is not changed). Upper limit of pressure controller at zero flow must be 35 kPa. (Supplier of the valve should provide lab test results). Nominal pressure rating 16 bar.

UnoFloor Control

Pre-assembled pressure independent underfloor heating balancing and control distribution unit must come wired and pre-mounted, suitable for left- or right-hand side connection to the manifold, fitted in in-wall cabinet.

Cabinet must be painted in white (RAL 9016), X mm in height, up to X mm in width and X mm in depth.

It must be possible to connect the room thermostats to the NC actuators via a connection box. The connection box must have not less 8 channels and 14 actuator outputs, have two potential free relays: one for the pump and one for the boiler. Distribution voltage: 230 V AC. Voltage: 230 V AC, max. power per output: 3 W

The manifold is used for heat regulation in floor heating systems. Each circuit in the floor heating system is connected to the manifold, which makes it possible to regulate the heat supply to each room in the building independently.

The manifold shall consist of a flow and return manifold where the flow manifold must be able to close each circuit independently. The return manifold must be equipped with presetting valves, ensuring optimal balancing of the system. Flow control of the floor heating system shall be done on a visible presetting scale, so that the value can be read and checked after commissioning. Valves shall be controlled electronically by thermal actuators installed without adapters.

The manifold must be provided in modules with air vent and drain / II function valve.

The manifold must be made of stainless steel and have the following specifications:

- Maximum flow temperature : 90 °C;
- Maximum differential pressure: 0,6 bar;
- Maximum operating pressure: 6 bar;
- Max Kv setting of the valve (N): 0,97 m²/h.

The actuator must be pre-mounted on a valve. The actuator receives a signal from the room thermostat. Based on the signal, it opens and closes the valve which makes it possible to regulate the energy supply to each room in the building independently. For easy and secure installation, the actuator must be delivered as one part (no adapter) and mounted on the manifold by use of an Allen screw.

The pressure independent balancing and control set must consist of a linear control valve, impulse tube with adapters to it, 3-piece ball valve with connection to impulse tube and heat meter, connector to manifold . The valve could be used as an automatic flow limiter. The valve should have a mechanism to adjust the flow from 100 % to 0 % of the maximum flow. Maximum recommended flow setting should not be more than 600 l/h at maximum system pressure drop 10 kPa, and no more than 915 l/h at maximum system pressure drop 5 kPa. Shut off service function should be possible with setting mechanism. The authority of the pressure independent control valve should be 1 at all settings (control valve characteristic is not changed). Upper limit of pressure controller at zero flow must be 35 kPa. (Supplier of the valve should provide lab test results). Nominal pressure rating 16 bar.

It must be possible for the installer to set up the underfloor heating control via an app. In the app, it must be possible to generate a commissioning report as a PDF that can be sent to the building owner as documentation.

It must be possible to offer the user an app from which he can control the heat in his home.

Contact details

Online support

Danfoss offers a wide range of support along with our products, including digital information, software, mobile apps and expert guidance. See the possibilities below.



The Danfoss Design center

Discover the Design Center, our advanced digital platform that streamlines product selection. With integrated tools and enhanced type pages, it's simpler than ever to access product information and documentation, and to select the right products. Check the availability of Danfoss products at partner locations and enjoy seamless transitions from selection to purchase with our basket-to-basket functionality. Whether you're buying from our distributors or directly from the Product Store, the Design Center simplifies your experience. Learn more at: designcenter.danfoss.com.



The Danfoss product store

The Danfoss Product Store is a one-stop shop available 24/7 for our customers, no matter where you are in the world or what area of industry you work in. Browse our catalog, check product details and documentation, view your prices and product availability, and quickly finalize your purchase. Start browsing at: store.danfoss.com.



Danfoss Partner Portal/Product Data tool

Designed to support you with easy access to product data extracts, essential resources, tools, and information. The Partner Portal provides a centralized hub for product documentation, training materials, marketing assets, and technical support, ensuring you have everything you need to succeed and grow your business with Danfoss. The Partner Portal is available 24/7 at: partner.danfoss.com and is ready to support your business.



Find technical documentation

Find technical documentation you need to get your project up running. Get direct access to our official collection of data sheets, certificates and declarations, manuals and guides, 3D models and drawings, case stories, brochures, and much more. Start searching now at: documentation.danfoss.com.



Danfoss Learning

Danfoss Learning is a free online learning platform. It features courses and materials specifically designed to help engineers, installers, service technicians, and wholesalers better understand the products, applications industry topics, and trends that will help you do your job better. Find your local Danfoss website here: learning.danfoss.com.



Get local information and support

Local Danfoss websites are the main sources for help and information about our company and products. Find product availability, get the latest regional news, or connect with a nearby expert - all in your own language. Find your local Danfoss website here: danfoss.com.

Danfoss A/S

Climate Solutions . danfoss.com . +45 7488 2222

Any information, including, but not limited to information on selection of product, its application or use, product design, weight, dimensions, capacity or any other technical data in product manuals, catalogues description, advertisements, etc. and whether made available in writing, orally, electronically, online or via download, shall be considered informative, and is only binding if and to the extent, explicit reference is made in a quotation or order confirmation. Danfoss cannot accept any responsibility for possible errors in catalogues, brochures, videos and other material. Danfoss reserves the right to alter its products without notice. This also applies to products ordered but not delivered provided that such alterations can be made without changes to form, fit or function of the products. All trademarks in this material are property of Danfoss A/S or Danfoss group companies. Danfoss and the Danfoss logo are trademarks of Danfoss A/S. All rights reserved.
