

Installation Guide

DEVIreg™ Solo (White)

Energy-efficient programmable indoor thermostat

DEVI 
by Danfoss

Make it easy,
make it DEVI



Table of contents

1	Introduction	4
2	Box contents	5
3	Installation guideline	7
3.1	Thermostat placement.....	7
3.2	Floor sensor and floor constructions.....	10
3.3	Wire connection.....	12
3.4	Thermostat installation.....	14
4	User guide	17
5	Technical specification	25
6	Standard Compliance	27
7	Safety instruction	28
8	Eco Design Sheet	30
9	Warranty	35
10	Disposal instruction	38

1 Introduction

The **DEVireg™ Solo** is a thermostat for use with electric floor heating. The thermostat has multiple control modes: Floor, Room + Floor, only Room*, and Power regulation*. The thermostat has Pulse Width Modulation which provides an efficient way of controlling your electric floor heating system.

**available ONLY for concrete floor construction with tiles flooring!*

The thermostat is specifically designed for wall mounting in standard EU boxes, in and on wall, and can be used for control of total heating as well as comfort heating of the room. The thermostat supports a selection of commonly used frame systems for 55x55 (inner geometry) framing systems.

Among others, the thermostat has the following features and advantages:

- ECO design LOT20 compliance.
- A color touchscreen display.
- User friendly **all-in-one setup** from the thermostat.
- Compatible with multiple 3rd party NTC sensors.
- Support for 55x55 mm like frame systems.
- Manual sensors temperature calibration.
- Fully standalone operation – no mobile apps, no connectivity dependencies.

2 Box contents



Front display of the thermostat



Power supply



Frame, 55x55 mm



Floor sensor, DEVI 15kOhm
@ 25°C, 3 m



Installation guide

Before beginning installation, please ensure that all the following items are included in the box:

1. Front display of the thermostat, 1 pc.
2. Power supply, 1 pc.
3. Frame 55x55 mm, 1 pc.
4. Floor sensor, DEVI 15 kOhm @ 25 °C, 3 m
5. Installation guide, 1 pc.

Note: If any items are missing or damaged, please contact customer support before installation.

3 Installation guideline

3.1 Thermostat placement

Install the thermostat on the wall at an appropriate height (usually 150 cm).

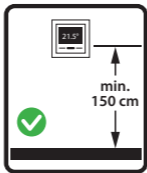

It is always recommended to install a floor sensor but **MANDATORY** for **wooden** or similar materials floor constructions.

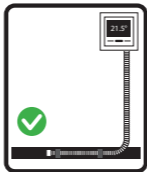

DO NOT place the thermostat in a place where it is exposed to direct sunlight or heating appliances.



DO NOT install the thermostat in direct wet areas (Zones 0, 1 and 2). Always follow local regulations regarding IP classes, this doesn't mean that the thermostats can't be installed in bathrooms.



DO NOT place the thermostat on the inside of a poorly insulated exterior wall.



DO NOT install the thermostat closer than 50 cm from window and door openings.



3.2 Floor sensor and floor constructions

Insert the floor sensor into the conduit pipe and close the end part. The bending radius of the conduit pipe must be >50 mm.



Make sure the floor temperature sensor is positioned midway between the two heating cables at the same level.

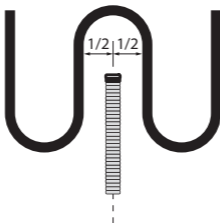

ALWAYS use the floor sensor for wooden or similar materials
floor constructions!

Concrete floor constructions

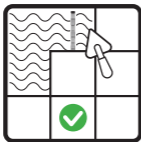

Temperature control

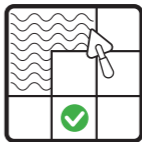

Power regulation

Wooden floor constructions



Temperature control



Power regulation

ALWAYS use the floor sensor for wooden or similar materials floor constructions!

3.3 Wire connection

Make sure that the electric circuit is de-energized, turn off the all pole disconnectors.

Connect the wires according to the wiring diagram on back of the thermostat power supply.

Ensure that the terminals are properly fastened and wires are securely connected.

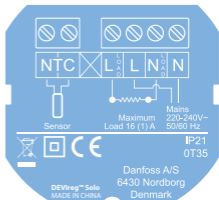

The screen/PE wire from the electric heating element must be connected to the PE wire from the main power supply using a separate connector.

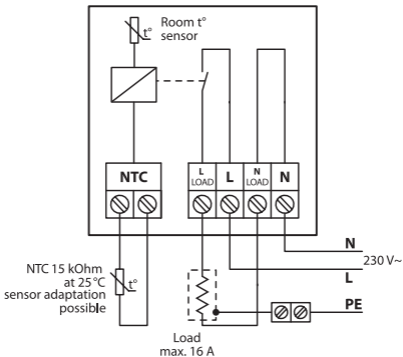

After completing the electrical installation, turn on the all-pole switch (fuse).

3.4 Thermostat installation

Install the thermostat power supply to the wall terminal box using screws in at least 2 of the marked holes on the power supply unit. Make sure all pole switches are off and there is no power.

Note: place the thermostat according to the UP arrow.

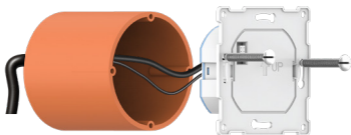

Remove the small plastic strip on the back of the front display to activate the battery backup feature.

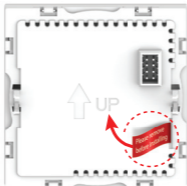

Attach the Front display to the frame. After that, attach these 2 parts to the power supply, pressing lightly until all parts are firmly connected.

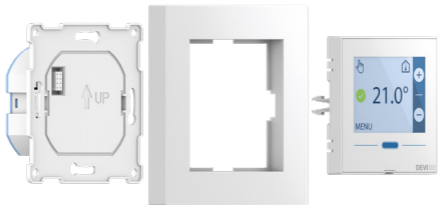

The assembled thermostat with all the parts looks like the picture below.



To remove the Front display, use a narrow tool, inserting it into the slot located on the bottom of the front, and tilting the tool downwards.



4 User guide

Your thermostat is now ready to use. Follow the on-screen instructions to set it up when the thermostat is activated for the first time.

During the **welcome screen**, the thermostat checks the system for errors. If any errors appear, please refer to the ERRORS page.



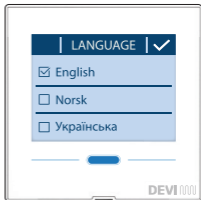

1. LANGUAGE

Select a language from the list and click the button  in the upper right corner to confirm.





2. TIME

Tap the hours/minutes and use the  and  arrows to set the time.

Tap to confirm 





3. DATE

Tap the day, month and year respectively and set the date using the  and  arrows and tapping to confirm .





4. SETUP WIZARD

On the SETUP information screen, tap  to start. You can always tap  button to read more about each function.



5. FLOORING TYPE



Use the  and  arrows to select the flooring type.

Tap  to confirm.

Note: ALWAYS use a floor temperature sensor for wooden or similar materials floor constructions!



6. CONTROL MODE



Use the  and  arrows to select whether to use only the floor sensor or a combination of room and floor sensors.

Tap  to confirm.

Note: Only Room and Power regulation options may also be available if the floor sensor is not connected and the Flooring type is Tiles.





7. FLOOR SENSOR TYPE

Use the  and  arrows to select the installed floor sensor type. The measured resistance and corresponding temperature are shown in brackets.

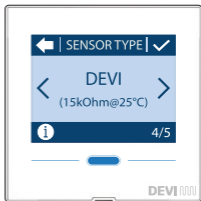
Tap  to confirm.



9. SYSTEM OUTPUT

Use the  and  arrows to select the approximate output of the heating elements.

Tap  to confirm.



10. FIRST SETUP is completed.

Now the first thermostat setup is completed and there are 2 options: view the on-screen symbol definitions or go directly to the home screen.



SYMBOLS DEFINITION

Screen icons **definitions** can be also found at any time under Settings/Info menu.



HOME SCREEN

All icons on the home screen are **clickable**, and a pop-up window with information appears.



QUICK ACCESS

The blue touch button can be used for quick access to important functions, returning to the home screen, or for a factory reset.



FACTORY RESET

To perform a factory reset, tap and hold the touch button for 5 seconds.

After 5 seconds of countdown, all settings are reset except:

Operation time (hours)

Relay ON (hours)

Relay ON (shifts)

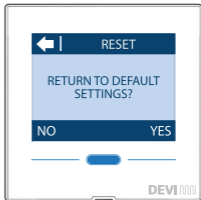

For more information, refer to the **User Guide**



DEVireg™ Solo **Virtual User Interface**. Here you can see for yourself how smart and simple DEVireg™ Solo is.



5 Technical specification

Operating voltage	220-240 V~, 50/60 Hz
Standby power consumption, max	1 W
Contact rating: - Resistive load - Inductive load	16 A / 3680 W @ 230 V Cos φ = 0,3 max. 1 A
Display type:	2" LCD color touch screen display 240x320 resolution
Floor sensor	NTC 15 k Ω @ 25 °C, 3 m. (default)* NTC 6.8 k Ω @ 25 °C, NTC 10 k Ω @ 25 °C, NTC 12 k Ω @ 25 °C, NTC 33 k Ω @ 25 °C, NTC 47 k Ω @ 25 °C
Control	PWM (Pulse Width Modulation)
Temperature control range	Room temperature: 5 °C to 35 °C Floor temperature: 5 °C to 35 °C
Ambient temperature range	0 °C to 35 °C
Frost protection	4 °C to 9 °C (default value 5 °C)
IP class	21
Protection class	Class II - 

Maximum cable size	1 x 4 mm ² or 2 x 2,5 mm ²
Controller type	1B
Software class	A
Pollution degree	II (Domestic use)
Over voltage category	III (4000 V)
Temperature for Ball pressure test	75 °C
Storage temperature	-25 °C to 60 °C, 90% RH non-condensing
Battery type or name	Coin battery Manganese Lithium, CR1220
Battery back-up time, min.	60 days
Dimensions	85 mm x 85 mm x 32 mm (in wall depth: 22 mm)
Weight	160 g

Note: The device shall be protected by an external over-current protective device not exceeding 16 A. Installation shall be carried out in accordance with local regulations.

6 Standard Compliance

Electrical safety, Electro-Magnetic Compatibility and Radio aspects for this product is covered by the compliance with the following relevant standards:

- EN/IEC 60730-1 (general)
- EN/IEC 60730-2-7 (timers and time switchers)
- EN/IEC 60730-2-9 (thermostat)

7 **Safety instruction**

Make sure that the mains power supply to the thermostat is shut off before starting the installation.

Important: If the thermostat is used to control a floor heating element, always use a floor temperature sensor and never set the maximum floor temperature higher than the manufacturer recommends for the specific floor type. The device is limited to a floor temperature of 35 °C due to compliance requirements.

If the top floor is made of laminate, parquet or solid wood, the unit must be limited to a maximum floor temperature of 27 °C unless otherwise described.

- Electric heating thermostats should always be installed in accordance with local building codes and electrical regulations. Installation should be carried out by an authorized and/or qualified installer.
- The thermostat must be used in a wall mounted installation supplied through an all-pole disconnection switch (fuse).
- Do not expose the thermostat to moisture, water, dust, and excessive heat.
- This thermostat can be used by children aged from 8 years and above and persons with reduced physical, sensory or mental capabilities or lack of experience and knowledge, if they have been given supervision or instruction concerning use of the appliance in a safe way and understand the hazards involved, by a person responsible for their safety.
- Children should be supervised to ensure that they do not play with the thermostat.
- The device is designed for permanent operation.

Error table

Error type	No	Description	Note
Floor Sensor disconnected.	E1	Connection to sensor is lost.	Contact installer or proceed with SETUP without floor sensor.
Floor Sensor short-circuited.	E2	Floor Sensor is short-circuited or wrong sensor is connected.	Contact installer or local DEVI service or change the floor sensor type.
Thermostat overheated.	E3	Thermostat is overheated, heating is turned off.	Wait until thermostat cools down.
Room sensor disconnected.	E4	Room temperature sensor value is too low.	Contact installer or local DEVI service.
Room sensor short-circuited.	E5	Room temperature sensor value is too high.	Contact installer or local DEVI service.
Unrecoverable error, Power supply.	E6	Power supply is detected as defective.	Contact installer or local DEVI service.

8 Eco Design Sheet

To comply with ECO design regulations for electric local space heaters 1103/2024 the following table is to be filled in with the specifics of the heating system. Herein the thermostat information for this specific product is prefilled, please fill any/all blank slots.

Information requirements for electric local space heaters

Model identifier(s): DEVireg™ Solo					
Item	Sym- bol	Value	Unit	Item	Unit
Heat output			Type of heat input, for electric storage local space heaters only (select one)		
Nominal heat output	P_{nom}		kW	manual heat charge control, with integrated thermostat	[yes/no]
Minimum heat output (indicative)	P_{min}		kW	manual heat charge control with room and/or outdoor temperature feedback	[yes/no]

Maximum continuous heat output	$P_{max,c}$		kW	electronic heat charge control with room and/or outdoor temperature feedback	[yes/no]
Auxiliary electricity consumption				fan assisted heat output	[yes/no]
At nominal heat output	el_{max}	<0,00062	kW	Type of heat output/ room temperature control (select one)	
At minimum heat output	el_{min}	<0,000465	kW	single stage heat output and no room temperature control	[no]
In standby mode	el_{SB}	<0,000464	kW	Two or more manual stages, no room temperature control	[no]
				with mechanic thermostat room temperature control	[no]

				with electronic room temperature control	[no]
				electronic room temperature control plus day timer	[yes]
				electronic room temperature control plus week timer	[yes]
				Other control options (multiple selections possible)	
				room temperature control, with presence detection	[no]
				room temperature control, with open window detection	[yes]

				with distance control option	[no]
				with adaptive start control	[no]
				with working time limitation	[no]
				with black bulb sensor	[no]
Contact details			Danfoss A/S, Nordborgvej 81, 6430 Nordborg, Denmark		

Control function codes

		Code of temperature control (TC)	Control functions							
			f1	f2	f3	f4	f5	f6	f7	f8
Type of temperature control	Single stage, no temperature control	NC								
	Two or more manual stages, no room temperature control	TX								
	Mechanic thermostat room temperature control	TM								
	Electronic room temperature control	TE								
	Electronic room temperature control plus day timer	TD								
	Electronic room temperature control plus week timer	TW								
Control functions	Presence detection		1							
	Open window detection			2						
	Distance control option				3					
	Adaptive start control					4				
	Working time limitation						5			
	Black bulb sensor							6		
	Self-learning functionality								7	
	Control accuracy with CA<2 Kelvin and CSD<2 Kelvin									8

This product contains TW(f2) control functions

9 Warranty



A 2-year product warranty is valid for:

- thermostats including DEVIreg™ Solo.

Should you, against all expectations, experience a problem with your DEVI product, you will find that Danfoss offers DEVIwarranty valid from the **date of purchase that was no later than 5 years from production date** on the following conditions:

During the warranty period Danfoss shall offer a new comparable product or repair the product if the product is found to be faulty by reason of defective design, materials or workmanship. The decision to either repair or replace will be solely at the discretion of Danfoss.

The decision to either repair or replace will be solely at the discretion of Danfoss. Danfoss shall not be liable for any consequential or incidental damages including, but not limited to, damages to property or extra utility expenses. No extension of the warranty period following repairs undertaken is granted.

The warranty shall be valid only if the WARRANTY CERTIFICATE is completed correctly and in accordance with the instructions, the fault is submitted to the installer or the seller without undue delay and proof of purchase is provided. Please note that the WARRANTY CERTIFICATE must be filled in, stamped and signed by the authorized installer performing the installation (Installation date must be indicated). After the installation is performed, store and keep the WARRANTY CERTIFICATE and purchase documents (invoice, receipt or similar) during the whole warranty period.

DEVIwarranty shall not cover any damage caused by incorrect conditions of use, incorrect installation or if installation has been carried out by non-authorized electricians. All work will be invoiced in full if Danfoss is required to inspect or repair faults that have arisen as a result of any of the above. The DEVIwarranty shall not extend to products which have not been paid in full. Danfoss will, at all times, provide a rapid and effective response to all complaints and inquiries from our customers.

The warranty explicitly excludes all claims exceeding the above conditions. For full warranty text visit **www.devi.com**.
devi.danfoss.com/en/warranty/

WARRANTY CERTIFICATE

The DEVI warranty is granted to:

Address

Stamp

Purchase date

Serial number
of the product

Product

Art. No.

*Connected
output [W]

Installation Date
& Signature

Connection Date
& Signature

**Not mandatory*

10 Disposal instruction



This symbol on the product indicates that it may not be disposed of as household waste.

It must be handed over to the applicable take-back scheme for the recycling of electrical and electronic equipment.

- Dispose of the product through channels provided for this purpose.
- Comply with all local and currently applicable laws and regulations.

Danfoss A/S
Nordborgvej 81
6430 Nordborg
Denmark

Danfoss A/S

DEVI • devi.com • +45 7488 8500 • E-Mail: EH@danfoss.com

Danfoss can accept no responsibility for possible errors in catalogues, brochures and other printed material. Danfoss reserves the right to alter its products without notice. This also applies to products already on order provided that such alterations can be made without subsequential changes being necessary in specifications already agreed. All trademarks in this material are property of the respective companies. DEVI and all DEVI logotypes are trademarks of Danfoss A/S. All rights reserved.

140F1172

DEVIreg™ Solo (White)

DEVI[®] 1000

by Danfoss

DESIGNED IN DENMARK



140R0200

Room thermostat
Floor/Room sensors
220 V-240 V ~ 50/60 Hz
16 A/3680 W @ 230 V
5 °C to 35 °C
IP21

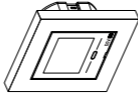

Danfoss Ltd. 22 Wycombe End
HP9 1NB, GB

WWW.DEVI.COM

MADE IN CHINA



5 703466 253885