

Data Sheet

Manual Presetting Valves LENO™ MSV-B

Description

LENO™ MSV-B is a new generation of manual valves for balancing flow in heating, cooling and domestic hot water systems.

LENO™ MSV-B is a combined presetting and shut off valve with a range of unique features:

- Removable hand wheel for easy mounting.
- Numeric presetting scale, visible from more angles.
- Easy locking of presetting.
- Built-in measuring nipples for 3mm needles.
- Open-close with Allen key in emergency.
- Open-closed colour indicator.

It is recommended to use LENO™ MSV-B in constant flow systems in front of boilers, flat stations or heat pumps in one-family houses for balancing, shut off function for service and repair, flow verification, one-pipe systems. The valve may be mounted in flow or return.

DN 15 valves are available with internal or external thread. Other dimensions with internal thread.

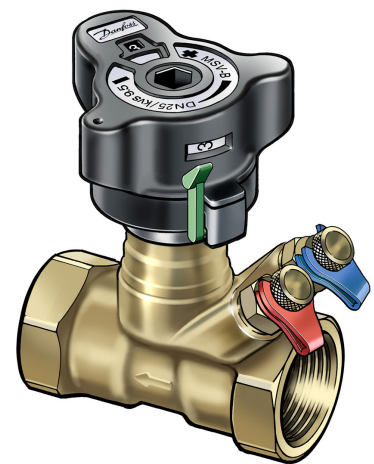

Danfoss PFM 5000/100 measuring instruments contain valve data for LENO™ MSV-B in memory.

Application

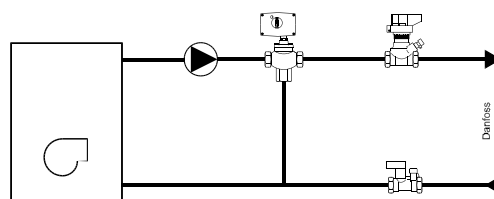

Boiler, flat station or heat pump in 1-family houses.

- For balancing.
- Shut-off function for service/repair.

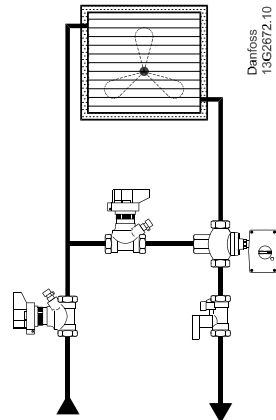

Air handling unit

- For constant flow.
- For balancing.
- Shut-off function for service/ repair.

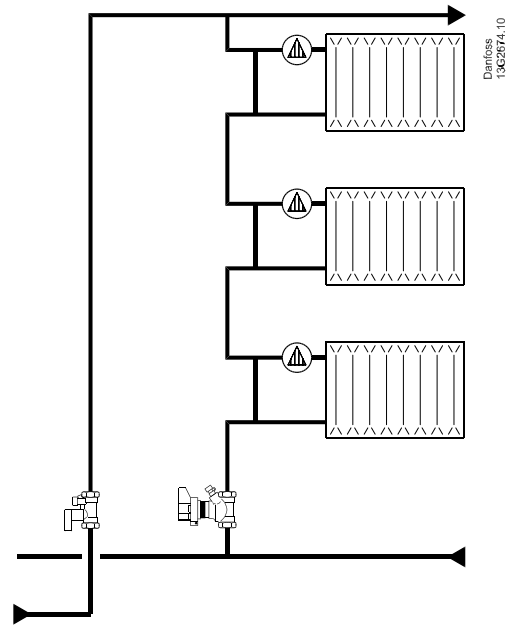

1-pipe system

- For balancing.
- Shut-off function for service/repair.

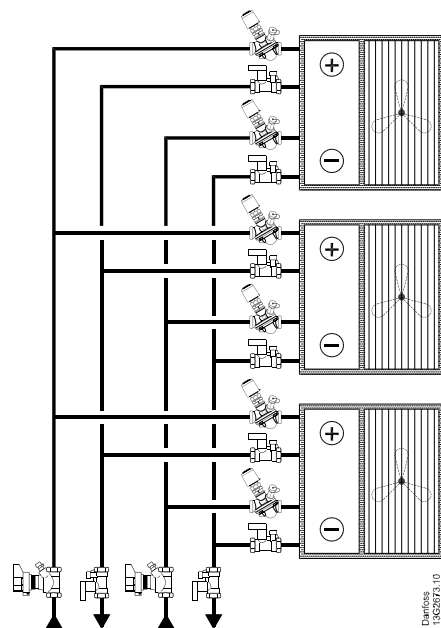

Fan coils

- For flow verification.
- Shut-off function for service/ repair.

Ordering

LENO™ MSV-B valve with internal thread

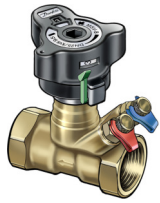
Type	Material	Size	k_{vs} (m ³ /h)	Connection	Code no.
	DZR* Brass	DN 15 LF	2.5	R _p 1/2"	003Z4030
		DN 15	3.0	R _p 1/2"	003Z4031
		DN 20	6.0	R _p 3/4"	003Z4032
		DN 25	9.5	R _p 1"	003Z4033
		DN 32	18	R _p 1 1/4"	003Z4034
		DN 40	26	R _p 1 1/2"	003Z4035
		DN 50	40	R _p 2"	003Z4036

LENO™ MSV-B valve with external thread

Type	Material	Size	k_{vs} (m ³ /h)	Connection	Code no.
	DZR* Brass	DN 15 LF	2.5	G 3/4 A**	003Z4131
		DN 15	3.0	G 3/4 A**	003Z4130

*Corrosion resistant brass

**Eurocone DIN V 3838

Accessories

Type	Code no.
Standard measuring nipples, 2 pcs.	003Z4662
Extended measuring nipples, 60 mm, 2 pcs.	003Z4657
Operating handle	003Z4652
Flow measuring instrument PFM 100	003L8260
Flow measuring instrument PFM 5000, PN 10	003L8331
Flow measuring instrument PFM 5000 Multi Source, PN 10	003L8333
Identification tag & strips, 10 pcs.	003Z4660

Compression fittings for valves with external thread

Pipe (mm)	Valve thread	PEX fittings, code no.	Alupex fittings, code no.
12 x 1.1	G 3/4	013G4150	
12 x 2	G 3/4	013G4152	013G4182
13 x 2	G 3/4	013G4153	
14 x 2	G 3/4	013G4154	013G4184
15 x 1.7	G 3/4	013G4165	
15 x 2.5	G 3/4	013G4155	013G4185
16 x 1.5	G 3/4	013G4157	
16 x 2	G 3/4	013G4156	013G4186
16 x 2.25	G 3/4		013G4187
17 x 2	G 3/4	013G4162	
18 x 2	G 3/4	013G4158	013G4188
18 x 2.5	G 3/4	013G4159	
20 x 2	G 3/4	013G4160	013G4190
20 x 2.5	G 3/4	013G4161	013G4191

Compression fittings for valves with external thread

Steel/copper pipes	Dimension	Code no.
	G 3/4 x 15	013G4125
	G 3/4 x 16	013G4126
	G 3/4 x 18	013G4128

Design

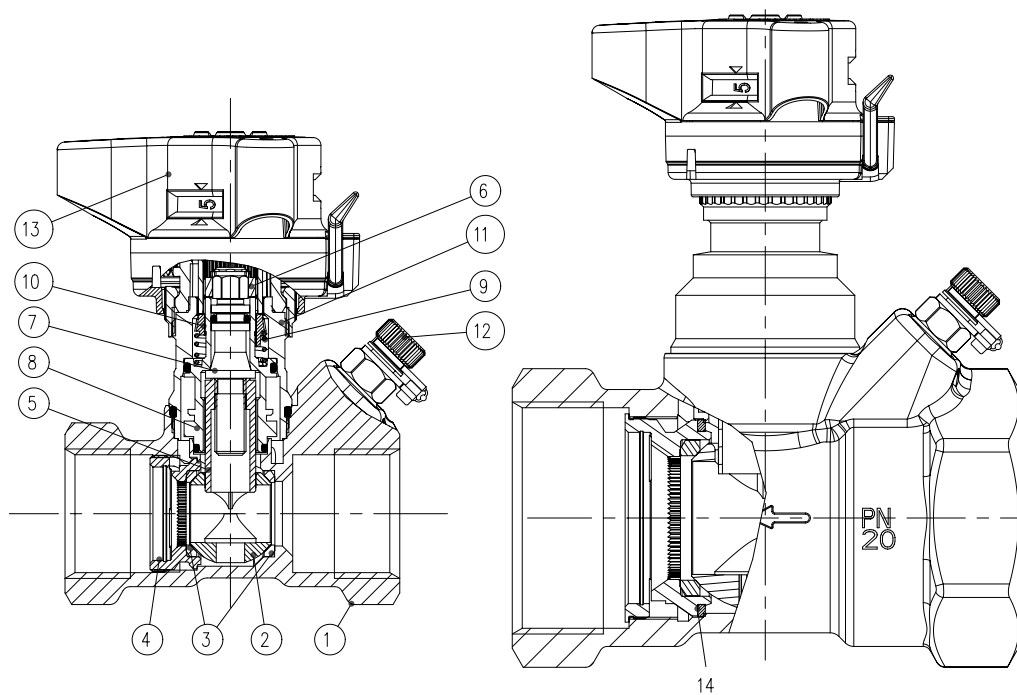

- | | | |
|------------------|-------------------|------------------------------|
| 1. Valve house | 6. Spindle head | 11. Top |
| 2. Ball | 7. Spindle | 12. Measuring nipple |
| 3. Ball seat | 8. Shut off bush | 13. Handle |
| 4. Support screw | 9. Spring | 14. Gasket for support screw |
| 5. Throttle | 10. Rotation lock | |

Technical Data

Materials and parts in contact with water

Valve body	DZR brass
O-rings	EPDM
Ball	Brass/chromium plated
Ball sealing	Teflon

Max. static working pressure	20 bar
Static test pressure	30 bar
Max. differential pressure across valve	2.5 bar (250 kPa)
Max. flow temperature	120 °C
Min. temperature	-20°C
Cooling liquids	Ethylene glycol / propylene glycol and HYCOOL (max. 30 %)

Fitting

Before fitting the valve the installer must ensure that the pipe system is clean and:

1. the valve can be turned 360 degrees (if threaded pipe is used).
2. the valve is fitted according to the flow direction arrow.

DN	R1/R2 (mm)
15	96/58
20	99/60
25	101/63
32	124/87
40	127/90
50	131/94

Removal of the handle

1. Set the handle at 0/0.
2. Release the setting lock (green).
3. Unscrew the union nut.

Calibration of the handle

Before refitting, ensure that the handle setting is 0/0.

For DN 15 valves with external thread Danfoss offers a complete range of compression fittings for steel, copper and PEX pipes.

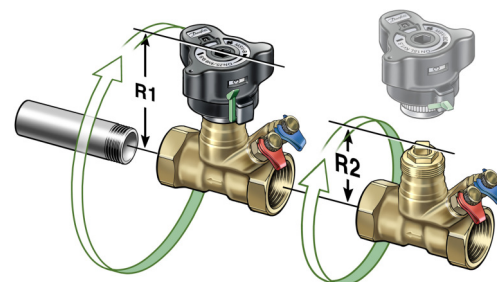

Shut-Off

In order to shut-off the valve the handle must be pressed down.

The shut-off function features a ball valve, which only requires a 90 degree turn to shut the valve completely.

An indicator window shows the actual setting:

- red = closed
- white = open

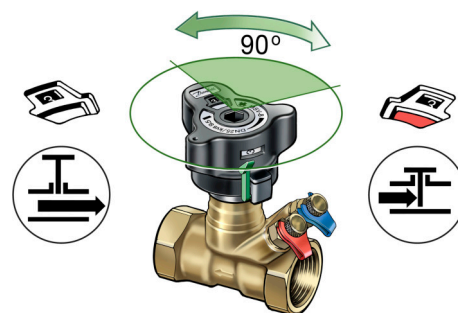

Setting and Locking

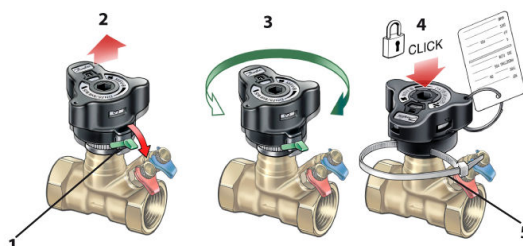

The valve has a built-in presetting feature for accurate flow ratings.

Setting the required flow is made in 5 steps:

1. In open position, release the lock using the green lever or a 3 mm Allen key.
2. The handle pops up automatically.

3. The calculated value can now be set.
4. The setting is locked when the handle is pressed to click.
5. Seal - the setting can be protected by using a strip as shown.

Measuring

The flow through the LENO™ MSV-B valve can be measured using Danfoss PFM 5000/100 or other brands of measuring instruments. The LENO™ MSV-B valve is supplied with two measuring nipples for 3 mm needles. A twin bracket enables the user to connect both needles simultaneously.

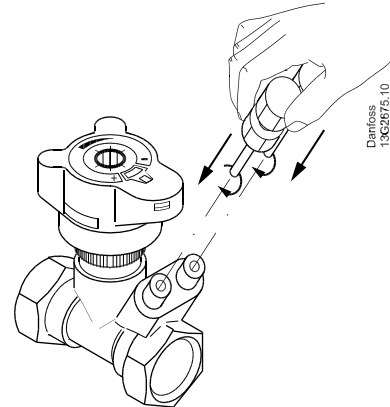

Procedure for flow measuring:

1. Select flow measuring
2. Select valve brand
3. Select valve type and dimension
4. Enter presetting
5. Connect valve and instrument
6. Calibrate static pressure
7. Measure the flow

Measuring Accuracy

Maximum error in measured flow [%]

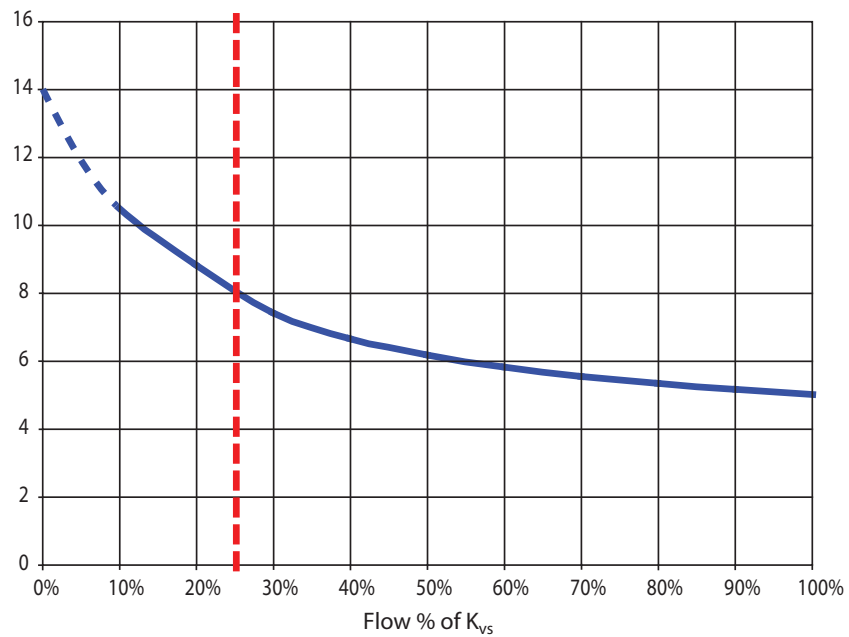

The red line indicates 25% of max. flow.

LENO™ MSV-B is very accurate, due to the separate functions for presetting and shut-off.

According to BS7350:1990 flow rates must be within following values:

- ± 18 % at 25 % open position
- ± 10 % at fully open position

K_v-Signal

K_v-signal values are used for non-Danfoss measuring instruments. Danfoss PFM 3000*/4000 have all data in memory, and the instruments are using this formula:

$$\Delta P_{val} = \Delta P_{sig} \left(\frac{k_{v-sig}}{k_{v-val}} \right)^2$$

Δp across the measuring nipples (k_{v-sig}) and Δp across the valve (k_{v-val}) is not the same due to turbulence influence for pressure measuring. * with software 9.4 or higher

K_v -Signal Values

Setting	DN 15LF	DN 15	DN20	DN25	DN32	DN40	DN50
0.0	0.07	0.10	0.12	0.34	0.51	1.05	1.75
0.1	0.08	0.11	0.16	0.44	0.73	1.20	2.01
0.2	0.09	0.12	0.20	0.53	0.92	1.36	2.25
0.3	0.11	0.13	0.26	0.61	1.10	1.55	2.47
0.4	0.12	0.14	0.32	0.67	1.26	1.74	2.69
0.5	0.13	0.16	0.38	0.73	1.43	1.95	2.91
0.6	0.15	0.19	0.45	0.79	1.60	2.17	3.12
0.7	0.16	0.21	0.53	0.84	1.78	2.40	3.35
0.8	0.17	0.24	0.60	0.90	1.97	2.64	3.58
0.9	0.19	0.26	0.67	0.95	2.18	2.88	3.82
1.0	0.20	0.29	0.74	1.01	2.39	3.13	4.07
1.1	0.21	0.32	0.82	1.08	2.62	3.39	4.33
1.2	0.23	0.34	0.89	1.14	2.87	3.64	4.60
1.3	0.25	0.37	0.96	1.22	3.12	3.90	4.89
1.4	0.27	0.40	1.03	1.29	3.38	4.16	5.18
1.5	0.30	0.44	1.09	1.37	3.64	4.43	5.49
1.6	0.32	0.47	1.16	1.46	3.92	4.69	5.80
1.7	0.35	0.51	1.23	1.55	4.18	4.96	6.13
1.8	0.37	0.54	1.30	1.65	4.48	5.24	6.46
1.9	0.40	0.58	1.38	1.75	4.76	5.51	6.80
2.0	0.43	0.61	1.45	1.85	5.05	5.80	7.14
2.1	0.46	0.65	1.53	1.96	5.35	6.08	7.49
2.2	0.49	0.69	1.61	2.07	5.65	6.38	7.84
2.3	0.52	0.73	1.69	2.18	5.96	6.68	8.19
2.4	0.56	0.77	1.78	2.29	6.27	6.99	8.55
2.5	0.59	0.80	1.87	2.41	6.60	7.30	8.91
2.6	0.62	0.85	1.97	2.53	6.94	7.63	9.27
2.7	0.66	0.89	2.07	2.65	7.29	7.98	9.64
2.8	0.69	0.93	2.17	2.77	7.67	8.33	10.00
2.9	0.73	0.97	2.29	2.89	8.06	8.70	10.37
3.0	0.76	1.01	2.40	3.01	8.48	9.08	10.74
3.1	0.80	1.04	2.52	3.13	8.92	9.48	11.11
3.2	0.83	1.08	2.65	3.25	9.38	9.90	11.49
3.3	0.87	1.12	2.78	3.37	9.87	10.33	11.88
3.4	0.90	1.16	2.91	3.49	10.38	10.79	12.27
3.5	0.94	1.20	3.05	3.62	10.91	11.26	12.67
3.6	0.97	1.25	3.19	3.74	11.46	11.74	13.09
3.7	1.01	1.30	3.33	3.87	12.02	12.25	13.51
3.8	1.06	1.35	3.47	4.00	12.58	12.77	13.95
3.9	1.10	1.41	3.61	4.13	13.12	13.30	14.41
4.0	1.14	1.47	3.75	4.26	13.64	13.85	14.88
4.1	1.18	1.53	3.89	4.39	14.12	14.41	15.38
4.2	1.23	1.59	4.02	4.53	14.52	14.98	15.89

4.3	1.27	1.66	4.15	4.68	14.84	15.55	16.44
4.4	1.31	1.73	4.28	4.82		16.13	17.00
4.5	1.35	1.81	4.40	4.98		16.69	17.59
4.6	1.39	1.91	4.52	5.13		17.25	18.21
4.7	1.43	2.00	4.62	5.29		17.80	18.86
4.8	1.47	2.08	4.72	5.46		18.32	19.54
4.9	1.51	2.16	4.82	5.64		18.80	20.24
5.0	1.54	2.23	4.90	5.81		19.25	20.97
5.1	1.60	2.30	4.97	6.00		19.65	21.73
5.2	1.66	2.36	5.04	6.19		19.98	22.51
5.3	1.72	2.41	5.09	6.38		20.24	23.30
5.4	1.79	2.46	5.14	6.57		20.41	24.12
5.5	1.87	2.50	5.18	6.77		20.48	24.94
5.6	1.93	2.54	5.21	6.96			25.76
5.7	1.99	2.57	5.24	7.15			26.58
5.8	2.04		5.27	7.34			27.38
5.9	2.09			7.52			28.16
6.0	2.14			7.69			28.90
6.1	2.18			7.85			29.59
6.2	2.22			7.98			30.21
6.3	2.26			8.09			30.74
6.4				8.17			31.17
6.5				8.22			31.47
6.6							31.61

Sizing

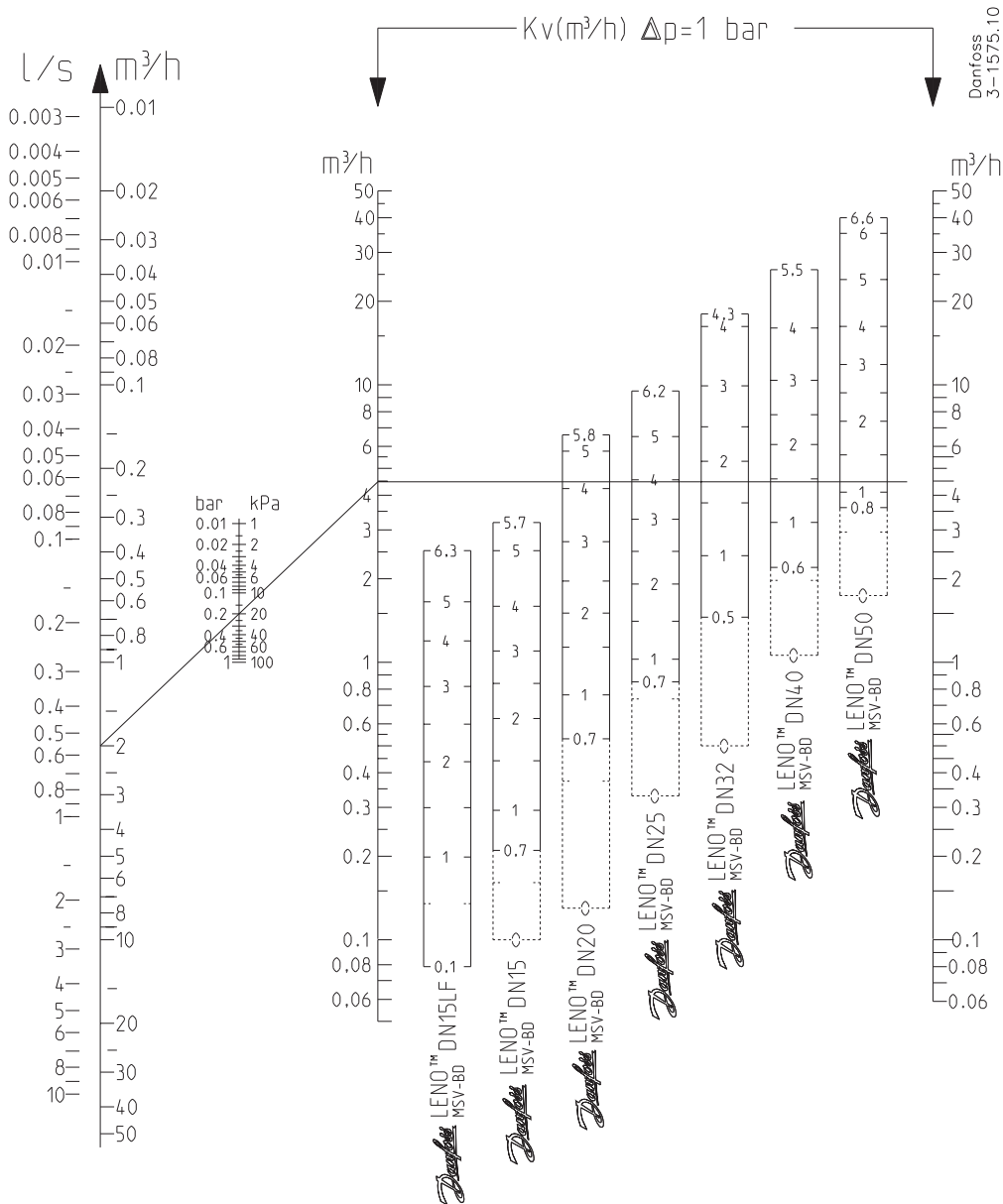

Correction Factors

Temp. °C	Correction factors, ethylene glycol / propylene glycol percentage (max. 30 %)						
	25	30	40	50	60	65	100
-40.0	1)	1)	1)	1)	0.89	0.88	1)
-17.8	1)	1)	0.93	0.91	0.90	0.89	0.86
4.4	0.95	0.95	0.93	0.92	0.91	0.90	0.87
26.6	0.96	0.95	0.94	0.93	0.92	0.91	0.88
48.9	0.97	0.96	0.95	0.94	0.93	0.92	0.90
71.1	0.98	0.98	0.96	0.95	0.94	0.94	0.95
93.3	1.00	0.99	0.97	0.96	0.95	0.95	0.92
115.6	2)	2)	2)	2)	2)	2)	0.94

1) Below freezing point

2) Above boiling point

Example: Flow needed = 30 m³/h
 Flow after correction:
 30 x 0.95 = 28 m³/h

Valve Size and Presetting

Example:

Given

- Max. pipe flow Q = 2.0 m³/h
- $\Delta p_r = 15 \text{ kPa}$
- $\Delta p_a = 45 \text{ kPa}$
- $\Delta p_m = 10 \text{ kPa}$
- $\Delta p_i = \Delta p_a - \Delta p_v - \Delta p_m$
- $\Delta p_i = 45 \text{ kPa} - 15 \text{ kPa} - 10 \text{ kPa} = 20 \text{ kPa}$

Correct valve size and presetting is found in flow diagramme, page 7.

Q = 2.0 m³/h and $\Delta p_i = 20 \text{ kPa}$

On page 12 intersect guides and presetting is found to be 4.2 (DN 20 valve)

Setting can be also calculated from the formula:

$$k_v = \frac{Q [m^3/h]}{\sqrt{\Delta p_i [bar]}} = \frac{2.0}{\sqrt{0.20}} = 4.5 \text{ m}^3/h$$

which corresponds to presetting 4.2 as shown on pages 7 and 12.

MSV-B

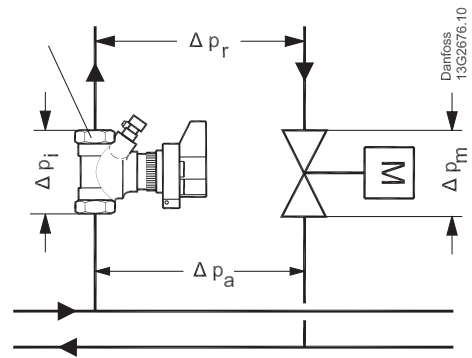

- Δp_i Pressure drop across LENO™ MSV-B valve
- Δp_m Pressure drop across valve
- Δp_r Necessary pressure for the riser
- Δp_a Available pressure for the riser

Flow Diagrammes, DN 15 LENO™ MSV-B DN 15 LF

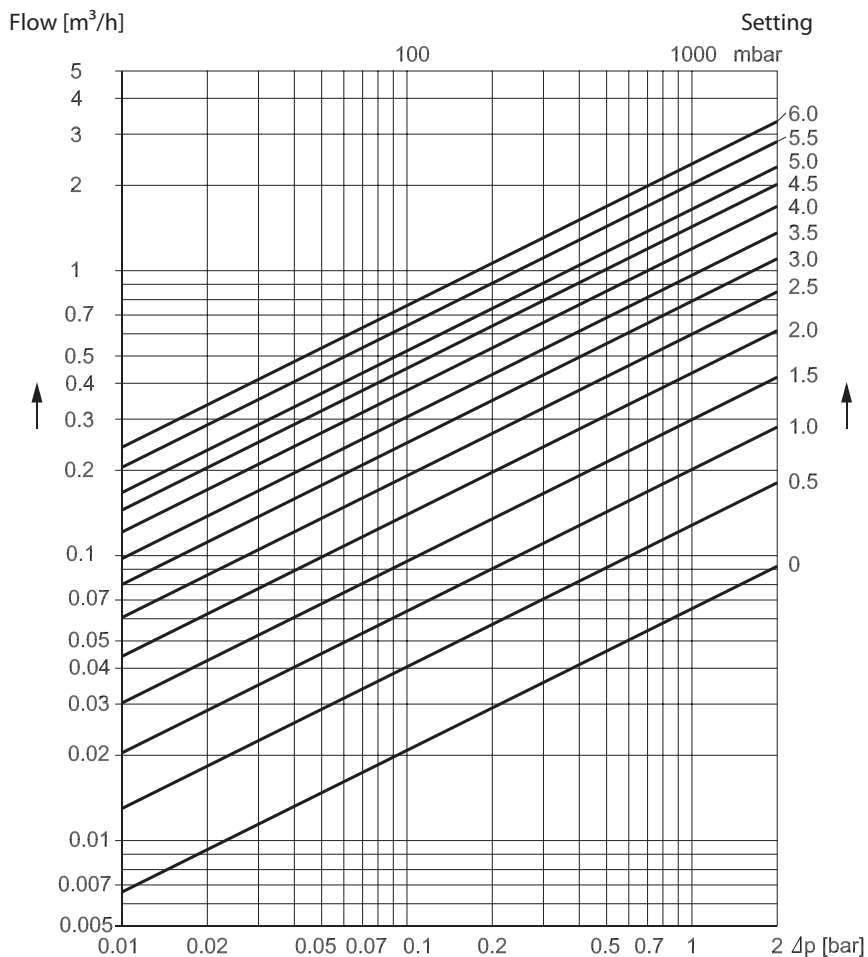

Setting	k _v -value
0.0	0.07
0.1	0.08
0.2	0.09
0.3	0.11
0.4	0.12
0.5	0.13
0.6	0.15
0.7	0.16
0.8	0.17
0.9	0.19
1.0	0.20
1.1	0.22
1.2	0.23
1.3	0.25
1.4	0.28
1.5	0.30
1.6	0.32
1.7	0.35
1.8	0.38
1.9	0.41
2.0	0.44
2.1	0.47
2.2	0.50
2.3	0.53

2.4	0.56
2.5	0.60
2.6	0.63
2.7	0.67
2.8	0.71
2.9	0.74
3.0	0.78
3.1	0.82

Setting	k_v -value
3.2	0.86
3.3	0.89
3.4	0.93
3.5	0.97
3.6	1.01
3.7	1.05
3.8	1.10
3.9	1.15
4.0	1.19
4.1	1.24
4.2	1.29
4.3	1.33
4.4	1.38
4.5	1.43
4.6	1.48
4.7	1.52
4.8	1.56
4.9	1.61
5.0	1.65
5.1	1.72
5.2	1.78
5.3	1.86
5.4	1.94
5.5	2.03
5.6	2.10
5.7	2.17
5.8	2.23
5.9	2.30
6.0	2.36
6.1	2.42
6.2	2.47

Flow characteristics

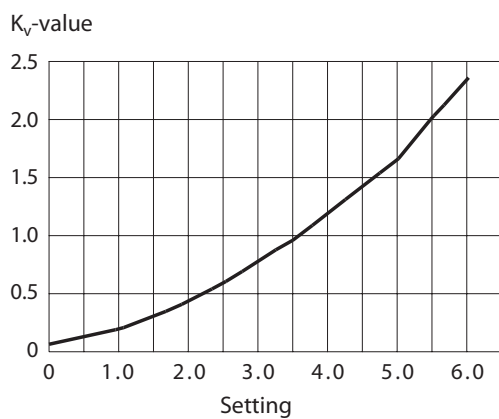

Flow Diagrammes, DN 15 LENO™ MSV-B DN 15

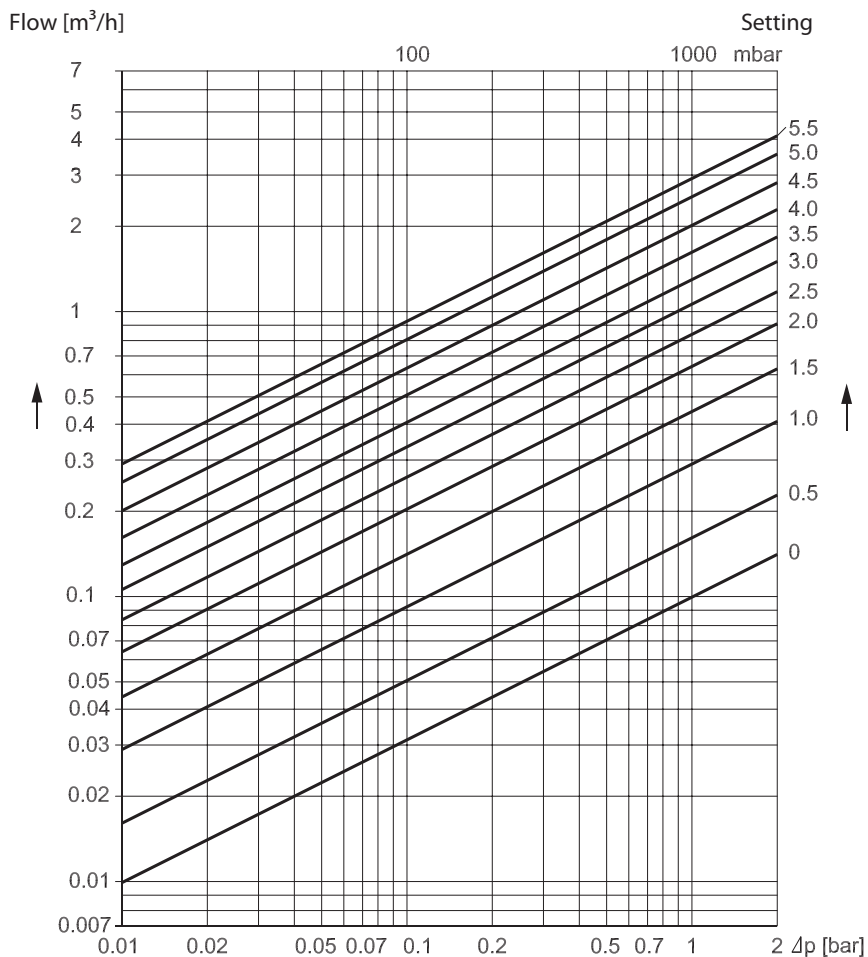

Setting	k_v -value
0.0	0.11
0.1	0.12
0.2	0.13
0.3	0.14
0.4	0.16
0.5	0.19
0.6	0.20
0.7	0.21
0.8	0.24
0.9	0.27
1.0	0.29
1.1	0.32
1.2	0.35
1.3	0.38
1.4	0.41
1.5	0.44
1.6	0.48
1.7	0.51
1.8	0.55
1.9	0.59
2.0	0.63
2.1	0.67
2.2	0.71
2.3	0.75

2.4	0.80
2.5	0.84
2.6	0.88
2.7	0.93
2.8	0.97

Setting	k_v -value
2.9	1.02
3.0	1.06
3.1	1.10
3.2	1.14
3.3	1.19
3.4	1.23
3.5	1.28
3.6	1.34
3.7	1.40
3.8	1.46
3.9	1.52
4.0	1.59
4.1	1.66
4.2	1.74
4.3	1.82
4.4	1.91
4.5	2.00
4.6	2.12
4.7	2.23
4.8	2.33
4.9	2.43
5.0	2.53
5.1	2.61
5.2	2.70
5.3	2.77
5.4	2.84
5.5	2.90
5.6	2.95
5.7	3.00

Flow characteristics

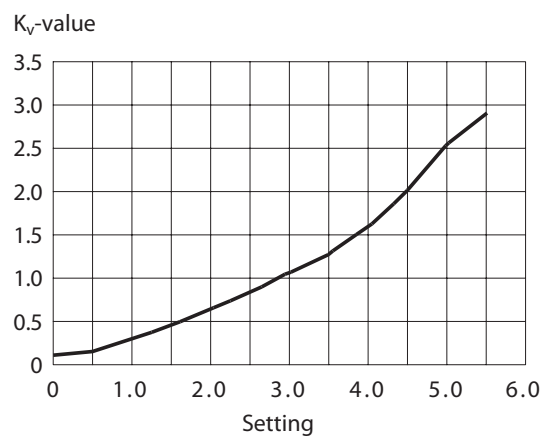

Flow Diagrammes, DN 20 LENO™ MSV-B DN 20

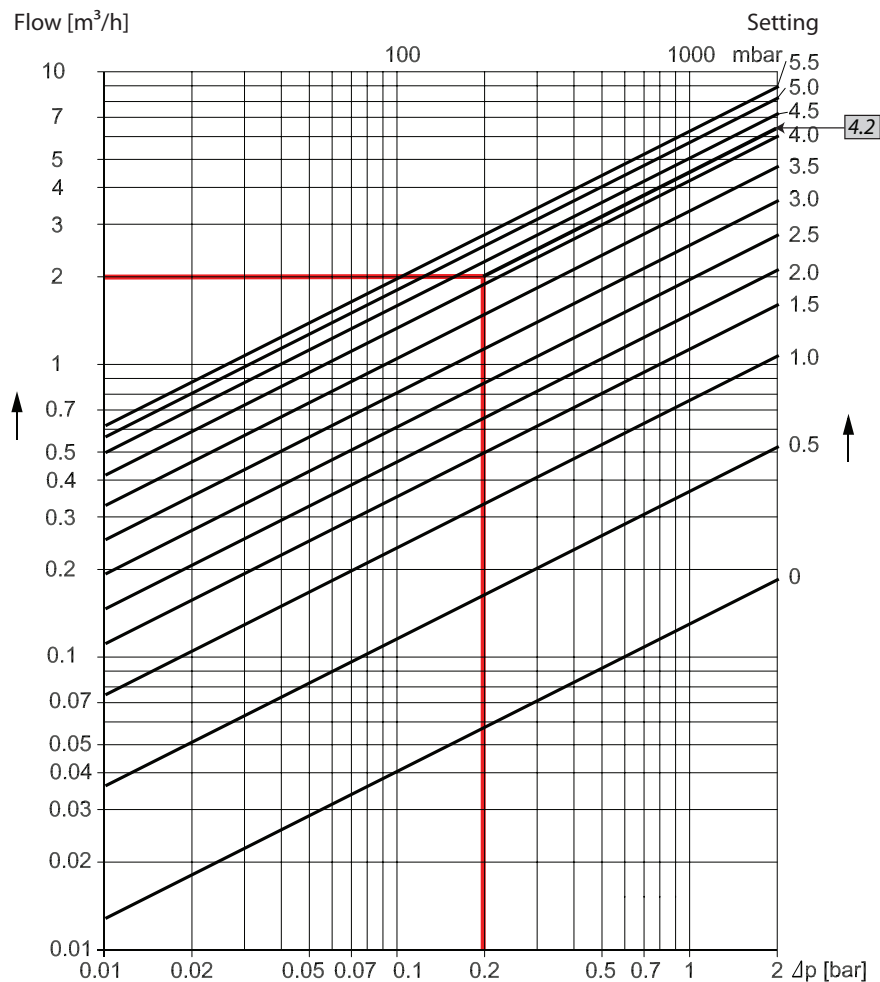

Setting	k_v -value
0.0	0.13
0.1	0.15
0.2	0.19
0.3	0.24
0.4	0.30
0.5	0.37
0.6	0.45
0.7	0.53
0.8	0.61
0.9	0.68
1.0	0.76
1.1	0.84
1.2	0.92
1.3	0.99
1.4	1.06
1.5	1.13
1.6	1.21
1.7	1.28
1.8	1.35
1.9	1.43
2.0	1.50
2.1	1.59
2.2	1.67

2.3	1.76
2.4	1.86
2.5	1.96
2.6	2.07
2.7	2.19
2.8	2.31

Setting	K_v -value
2.9	2.44
3.0	2.58
3.1	2.72
3.2	2.87
3.3	3.03
3.4	3.19
3.5	3.36
3.6	3.53
3.7	3.70
3.8	3.87
3.9	4.05
4.0	4.23
4.1	4.40
4.2	4.58
4.3	4.75
4.4	4.91
4.5	5.07
4.6	5.22
4.7	5.37
4.8	5.51
4.9	5.64
5.0	5.77
5.1	5.88
5.2	5.99
5.3	6.09
5.4	6.19
5.5	6.29
5.6	6.39
5.7	6.49
5.8	6.60

Flow characteristics

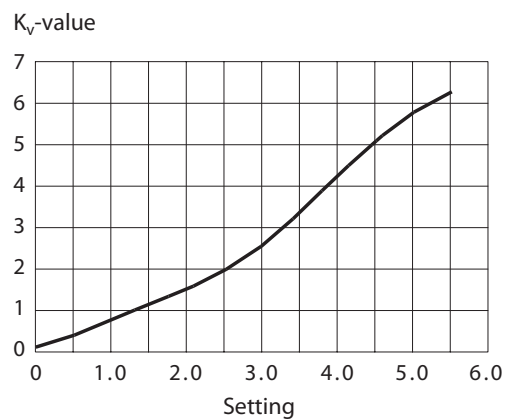

Flow Diagrammes, DN 25 LENO™ MSV-B DN 25

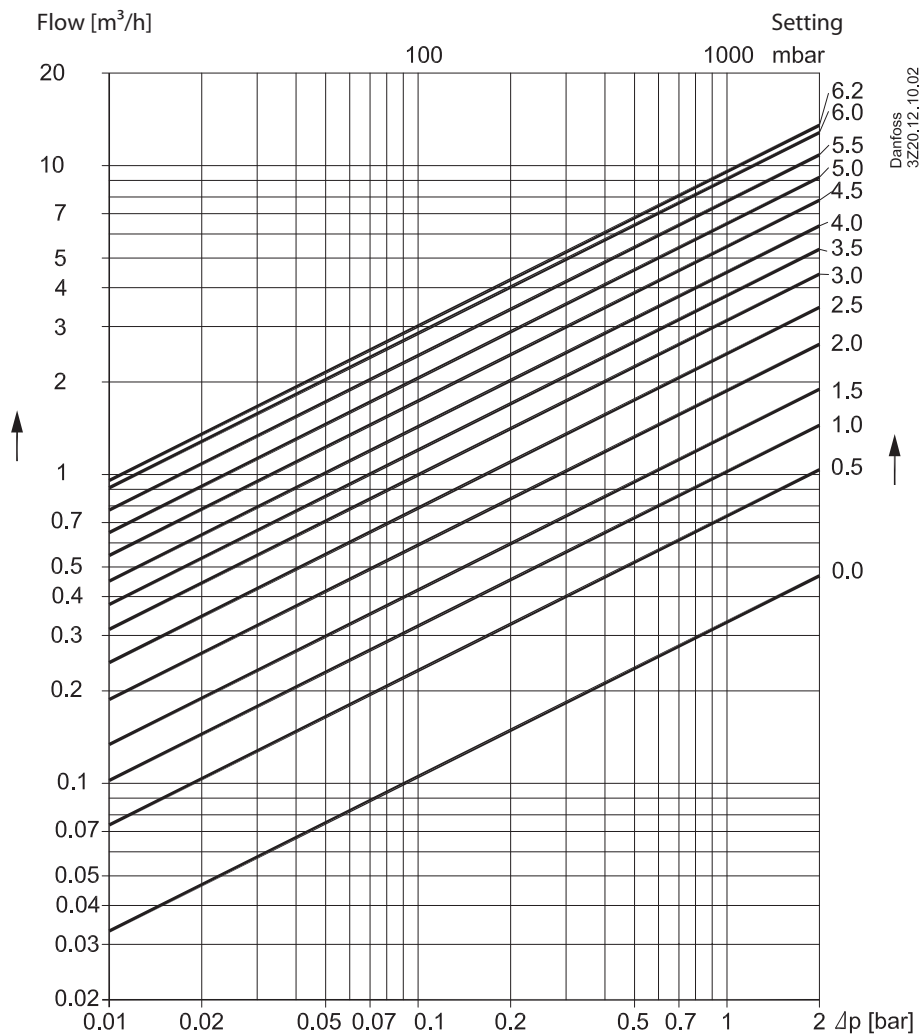

Setting	k_v -value
0.0	0.33
0.1	0.44
0.2	0.53
0.3	0.61
0.4	0.68
0.5	0.74
0.6	0.79
0.7	0.85
0.8	0.91
0.9	0.96
1.0	1.03
1.1	1.09
1.2	1.16
1.3	1.24
1.4	1.32
1.5	1.41
1.6	1.50
1.7	1.60
1.8	1.70
1.9	1.80

2.0	1.91
2.1	2.03
2.2	2.15
2.3	2.26
2.4	2.39
2.5	2.51
2.6	2.64
2.7	2.76
2.8	2.89
2.9	3.02
3.0	3.15

Setting	K_v -value
3.1	3.28
3.2	3.41
3.3	3.54
3.4	3.68
3.5	3.81
3.6	3.95
3.7	4.09
3.8	4.24
3.9	4.39
4.0	4.55
4.1	4.71
4.2	4.88
4.3	5.05
4.4	5.23
4.5	5.42
4.6	5.62
4.7	5.83
4.8	6.05
4.9	6.27
5.0	6.51
5.1	6.75
5.2	7.00
5.3	7.26
5.4	7.53
5.5	7.80
5.6	8.06
5.7	8.33
5.8	8.59
5.9	8.84
6.0	9.08
6.1	9.30
6.2	9.50

Flow characteristics

K_v -value

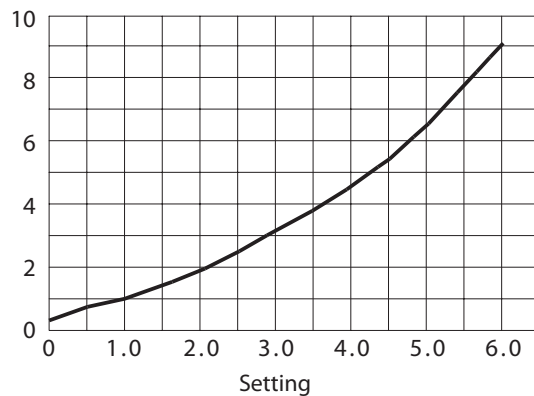

Flow Diagrammes, DN 32 LENO™ MSV-B DN 32

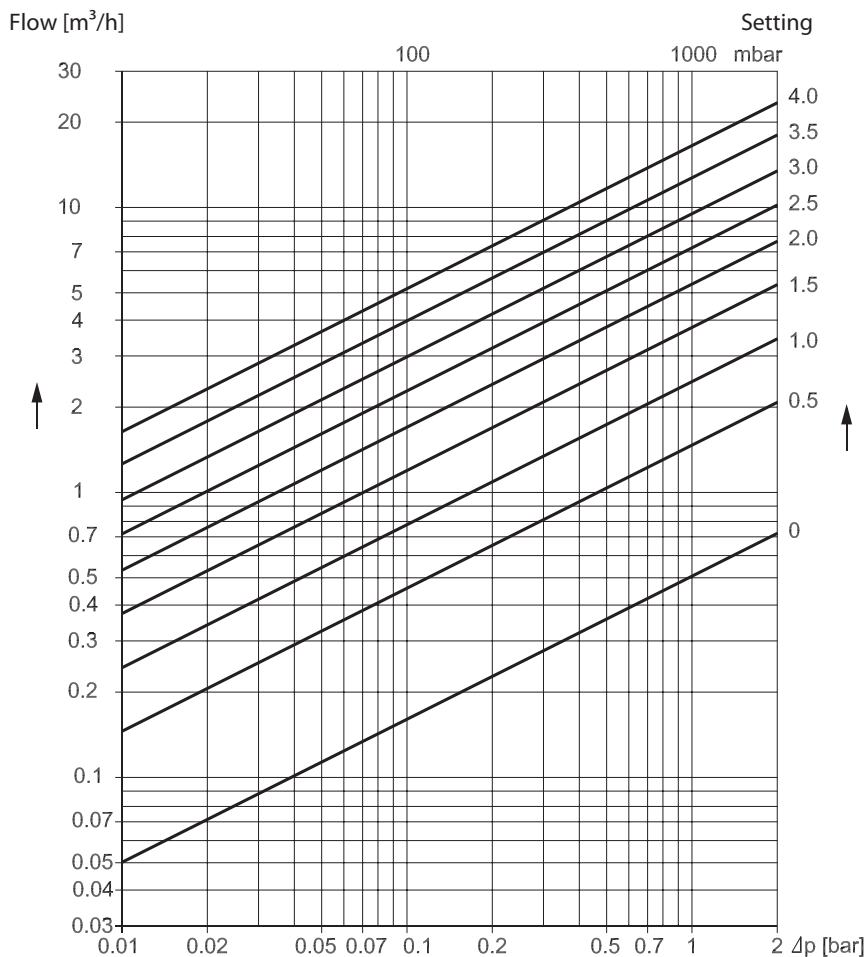

Setting	k_v -value
0.0	0.50
0.1	0.75
0.2	0.95
0.3	1.13
0.4	1.29
0.5	1.45
0.6	1.62
0.7	1.80
0.8	1.99
0.9	2.20
1.0	2.42
1.1	2.66
1.2	2.92
1.3	3.19
1.4	3.47
1.5	3.75
1.6	4.05
1.7	4.36
1.8	4.67
1.9	4.98
2.0	5.30
2.1	5.63

Setting	k_v -value
2.2	5.97
2.3	6.32
2.4	6.68
2.5	7.06
2.6	7.46
2.7	7.89
2.8	8.34
2.9	8.83
3.0	9.35
3.1	9.92
3.2	10.52
3.3	11.16
3.4	11.85
3.5	12.51
3.6	13.23
3.7	13.98
3.8	14.74
3.9	15.49
4.0	16.23
4.1	16.91
4.2	17.51
4.3	18.00

Flow characteristics

K_v -value

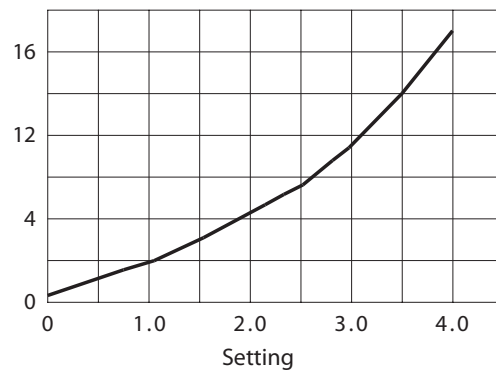

Flow Diagrammes, DN 40 LENO™ MSV-B DN 40

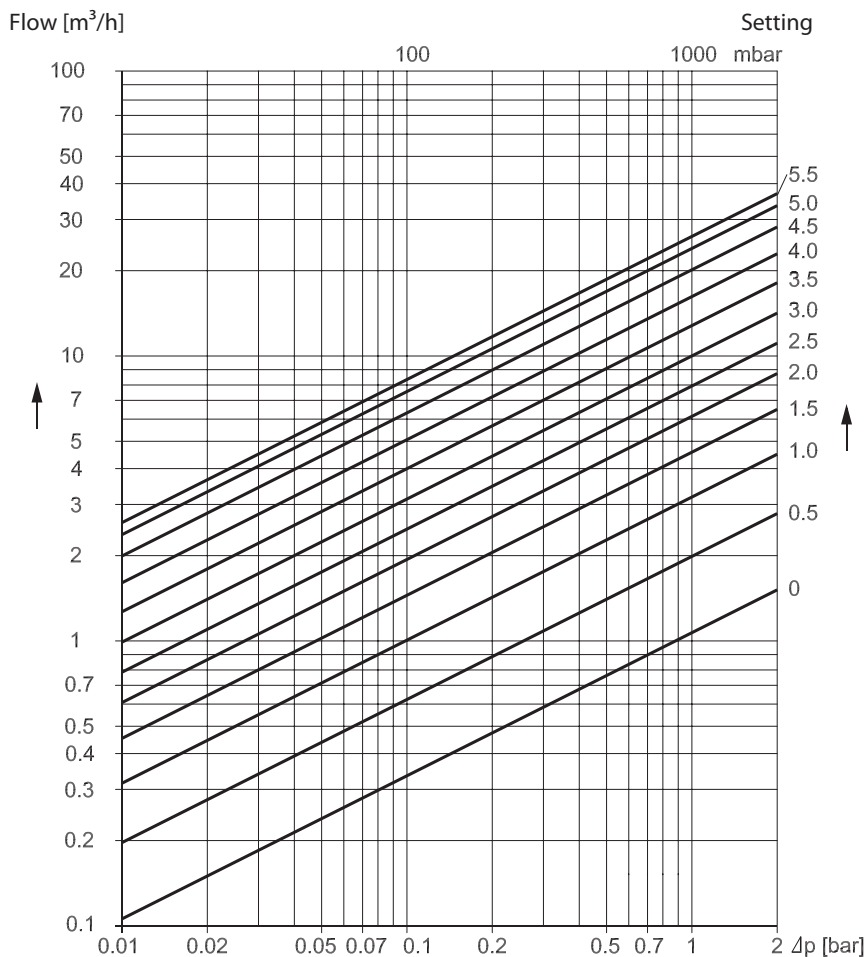

Setting	k _v -value
0.0	1.06
0.1	1.21
0.2	1.38
0.3	1.56
0.4	1.76
0.5	1.97
0.6	2.20
0.7	2.43
0.8	2.68
0.9	2.93
1.0	3.19
1.1	3.46
1.2	3.73
1.3	4.01
1.4	4.29
1.5	4.58
1.6	4.87
1.7	5.17
1.8	5.47
1.9	5.78
2.0	6.09
2.1	6.41
2.2	6.74
2.3	7.09

2.4	7.44
2.5	7.80
2.6	8.18
2.7	8.58

Setting	k_v -value
2.8	9.00
2.9	9.44
3.0	9.90
3.1	10.38
3.2	10.89
3.3	11.43
3.4	12.00
3.5	12.60
3.6	13.22
3.7	13.88
3.8	14.56
3.9	15.28
4.0	16.02
4.1	16.79
4.2	17.57
4.3	18.38
4.4	19.19
4.5	20.02
4.6	20.82
4.7	21.61
4.8	22.38
4.9	23.12
5.0	23.81
5.1	24.44
5.2	25.00
5.3	25.46
5.4	25.80
5.5	26.00

Flow characteristics

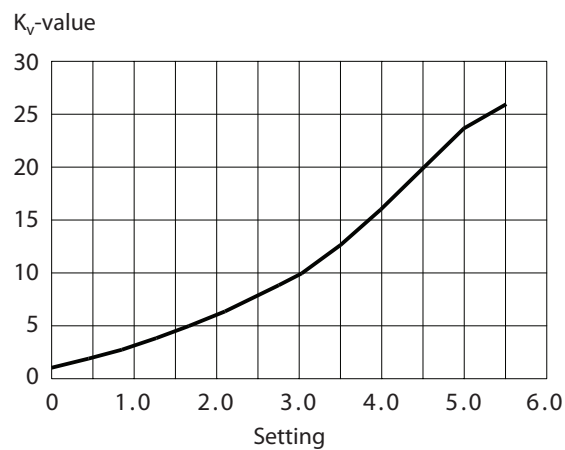

Flow Diagrammes, DN 50 LENO™ MSV-B DN 50

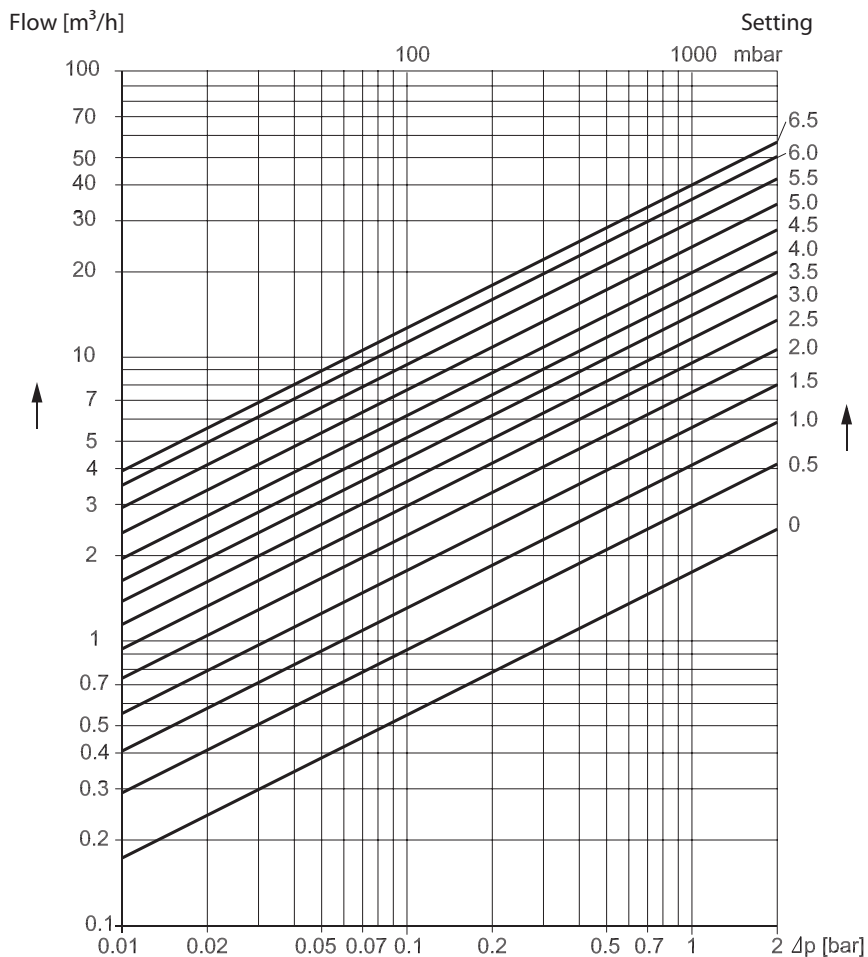

Setting	k _v -value
0.0	1.74
0.1	2.03
0.2	2.28
0.3	2.51
0.4	2.73
0.5	2.95
0.6	3.16
0.7	3.38
0.8	3.61
0.9	3.85
1.0	4.10
1.1	4.37
1.2	4.65
1.3	4.95
1.4	5.26
1.5	5.59
1.6	5.93
1.7	6.28
1.8	6.64
1.9	7.01
2.0	7.39
2.1	7.78
2.2	8.17
2.3	8.56

2.4	8.96
2.5	9.36
2.6	9.76
2.7	10.17
2.8	10.58
2.9	10.99
3.0	11.41
3.1	11.84
3.2	12.27

Setting	k_v -value
3.3	12.71
3.4	13.16
3.5	13.62
3.6	14.10
3.7	14.60
3.8	15.12
3.9	15.66
4.0	16.23
4.1	16.84
4.2	17.47
4.3	18.14
4.4	18.84
4.5	19.59
4.6	20.38
4.7	21.21
4.8	22.08
4.9	23.00
5.0	23.96
5.1	24.96
5.2	26.00
5.3	27.07
5.4	28.17
5.5	29.30
5.6	30.44
5.7	31.64
5.8	32.83
5.9	34.01
6.0	35.14
6.1	36.23
6.2	37.24
6.3	38.14
6.4	38.93
6.5	39.56
6.6	40.00

Flow characteristics

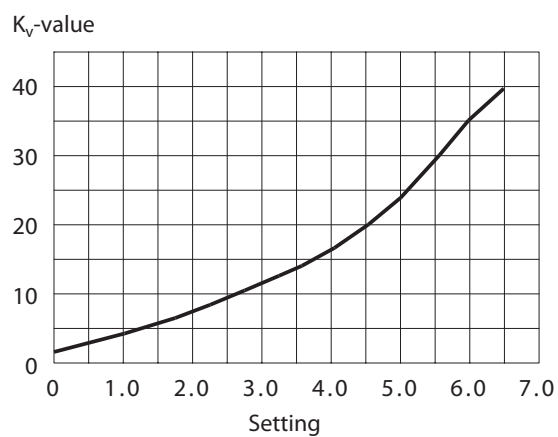

Dimensions

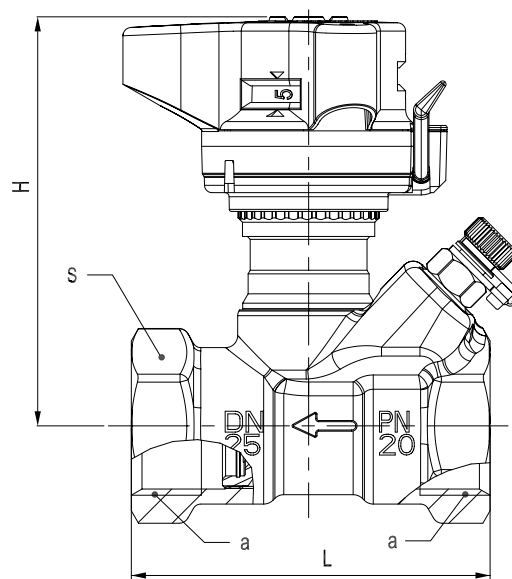
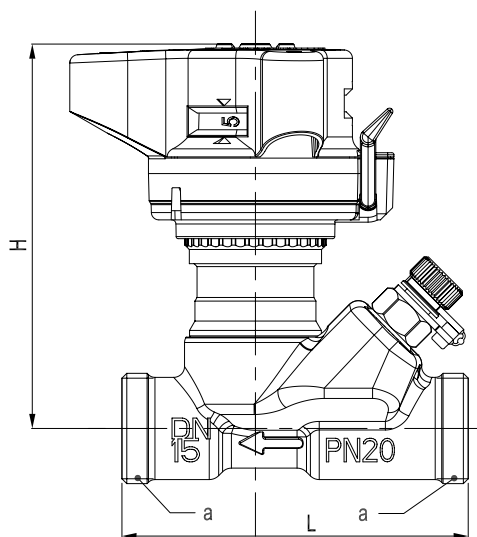

Size (DN)	ISO 228-1 a (mm)	L (mm)	H (mm)
15	G ¾ A	76	92

Size (DN)	ISO 228-1 a (mm)	L (mm)	H (mm)	S (mm)
15	G ½	76	92	27
20	G ¾	80	95	32
25	G 1	86	98	41
32	G 1¼	102	121	50
40	G 1½	102	125	55
50	G2	130	129	67

