

- NOTICE -

THIS DOCUMENT CONTAINS PROPRIETARY INFORMATION OF DANFOSS DRIVES. IT IS LOANED BY DANFOSS DRIVES SUBJECT TO THE CONDITIONS THAT IT AND THE INFORMATION EMBODIED THEREIN SHALL BE USED ONLY FOR RECORD AND REFERENCE PURPOSES. SHALL NOT BE USED OR CAUSED TO BE USED IN ANY WAY PREJUDICIAL TO THE INTERESTS OF DANFOSS DRIVES. SHALL NOT BE REPRODUCED OR COPIED IN WHOLE OR IN PART OR DISCLOSED TO ANYONE WITHOUT THE DIRECT WRITTEN PERMISSION OF DANFOSS DRIVES, AND SHALL BE RETURNED UPON REQUEST.

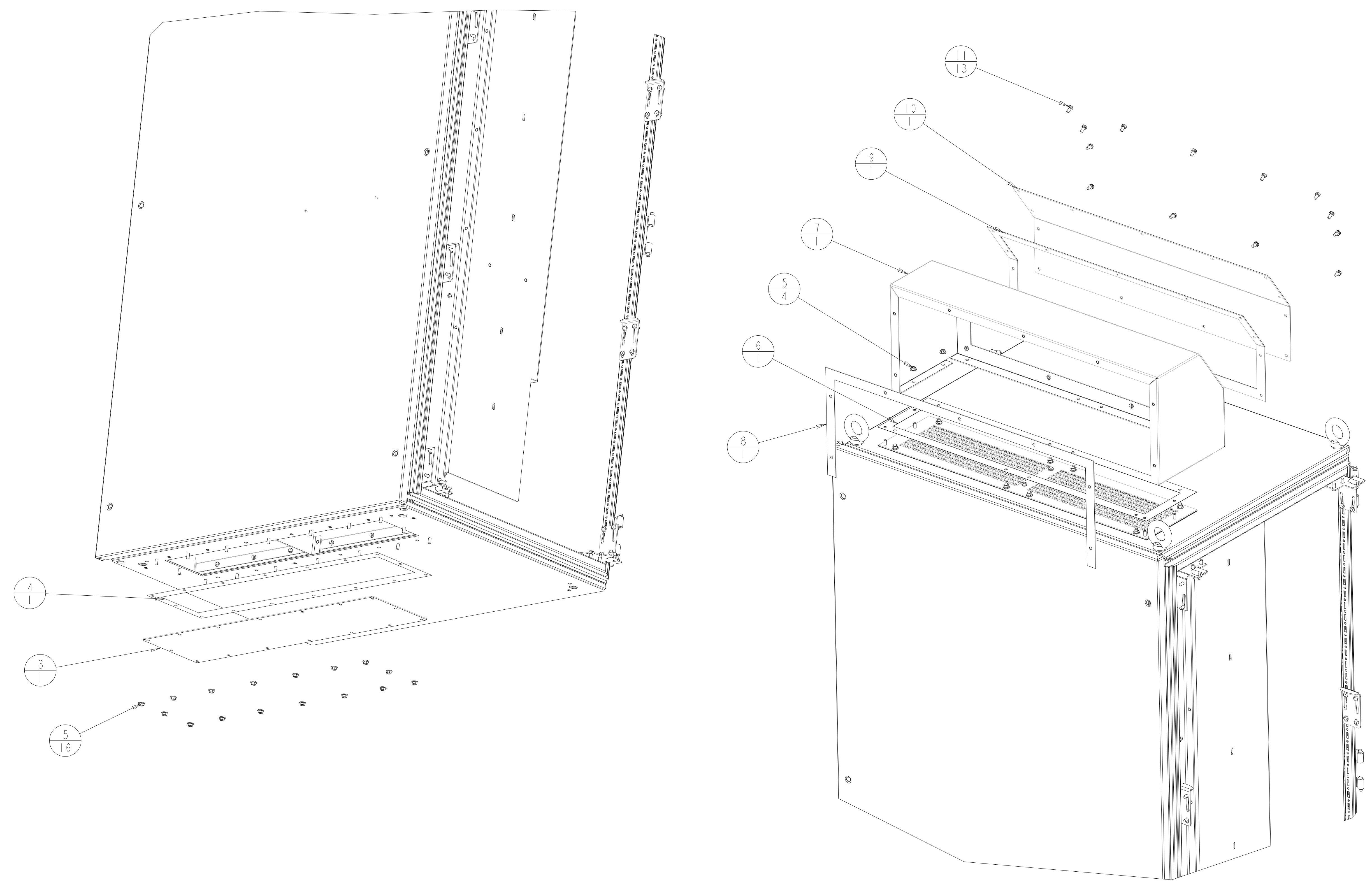

- NOTES:  
 1. FOR FASTENER TORQUES, REFER TO 175R5600 CLASS A. UNLESS OTHERWISE SPECIFIED.  
 2. PEDESTAL NOT SHOWN FOR CLARITY.  
 3. REFER TO 177R0039 DRAWING FOR DRIVE BACK WALL COOLING KIT DETAILS. 002

UNLESS OTHERWISE SPECIFIED INTERPRET DIM. AND TOL. PER ASME Y14.5M-1994 X±0.4 .XX±0.20 ≤±0.5 DIM. ARE IN MILLIMETERS WEIGHTS ARE IN KILOGRAMS THIRD ANGLE PROJECTION	PROPERTIES		 4401 N. BELL SCHOOL RD. LOVES PARK, ILLINOIS 61111 USA (815) 639-8000 FAX (815) 639-8000 KIT, F18, LHD, IP54, BACKWALL COOLING
	MATERIAL	SEE BOM	
	FINISH	NA	
	THICKNESS	NA	
EST. WEIGHT	NA	DATE	TITLE
DRAWN	KK	01/08/13	KIT, F18, LHD, IP54, BACKWALL COOLING
CHECKED			SIZE
ENGR	KD	09/03/14	D
			SCALE
			0.250
			MODEL
			LHD330-1P54-V2
			DRAWING NO.
			176F3534
			REV
			003
			SHEET
			1 OF 4

8

7

6

5

4

3

2

1

ITEM	PART #	QTY	NOTES
1	177R0514	1	INSTRUCTIONS
2	130G0724	1	PACKAGING
3	177G6749	1	
4	177G6750	1	
5	26513	20	
6	177G4401	1	
7	177G6752	1	
8	177G6753	1	
9	177G6754	1	
10	177G6755	1	
11	26412	13	
12	177G6838	1	

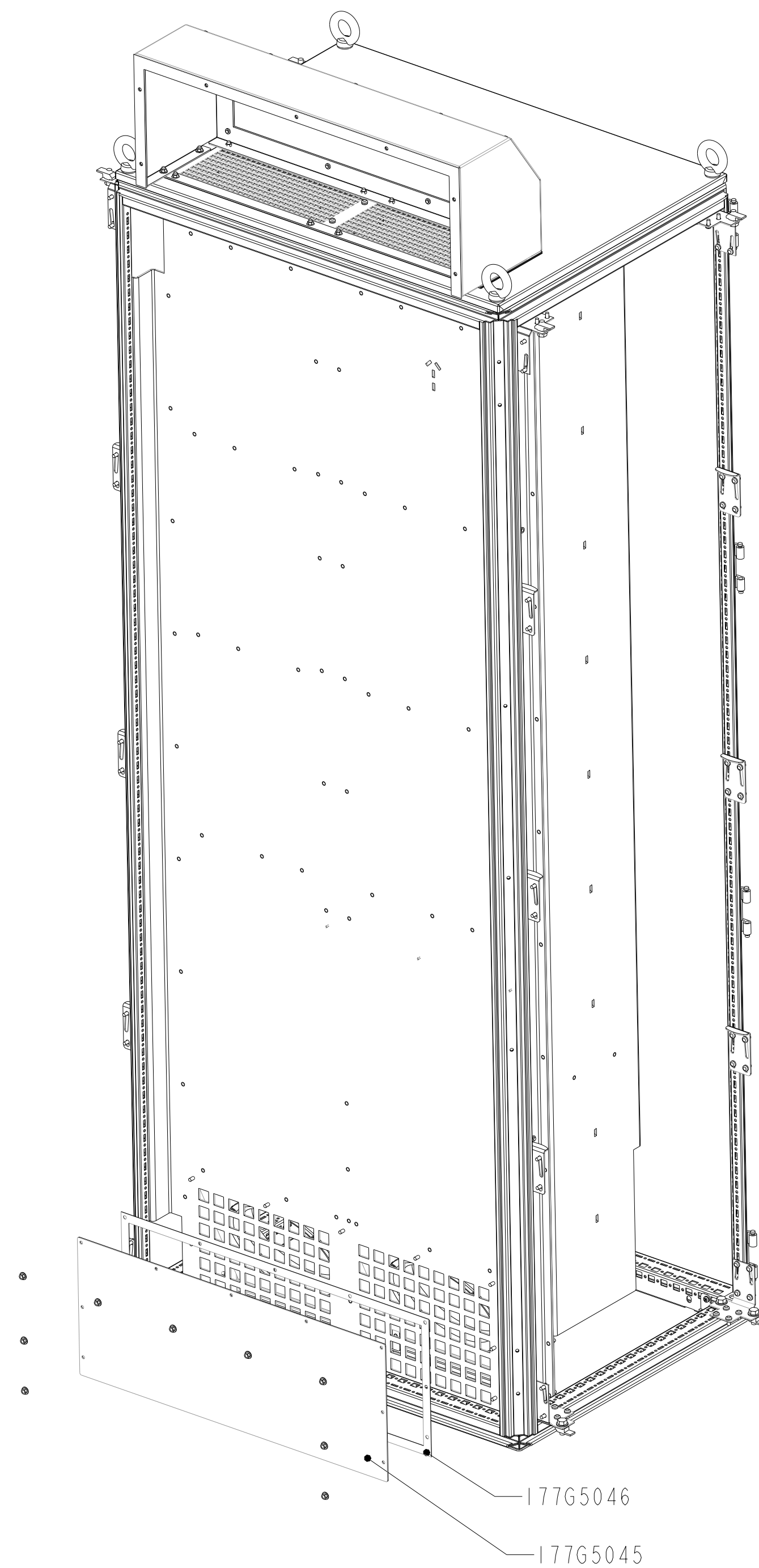
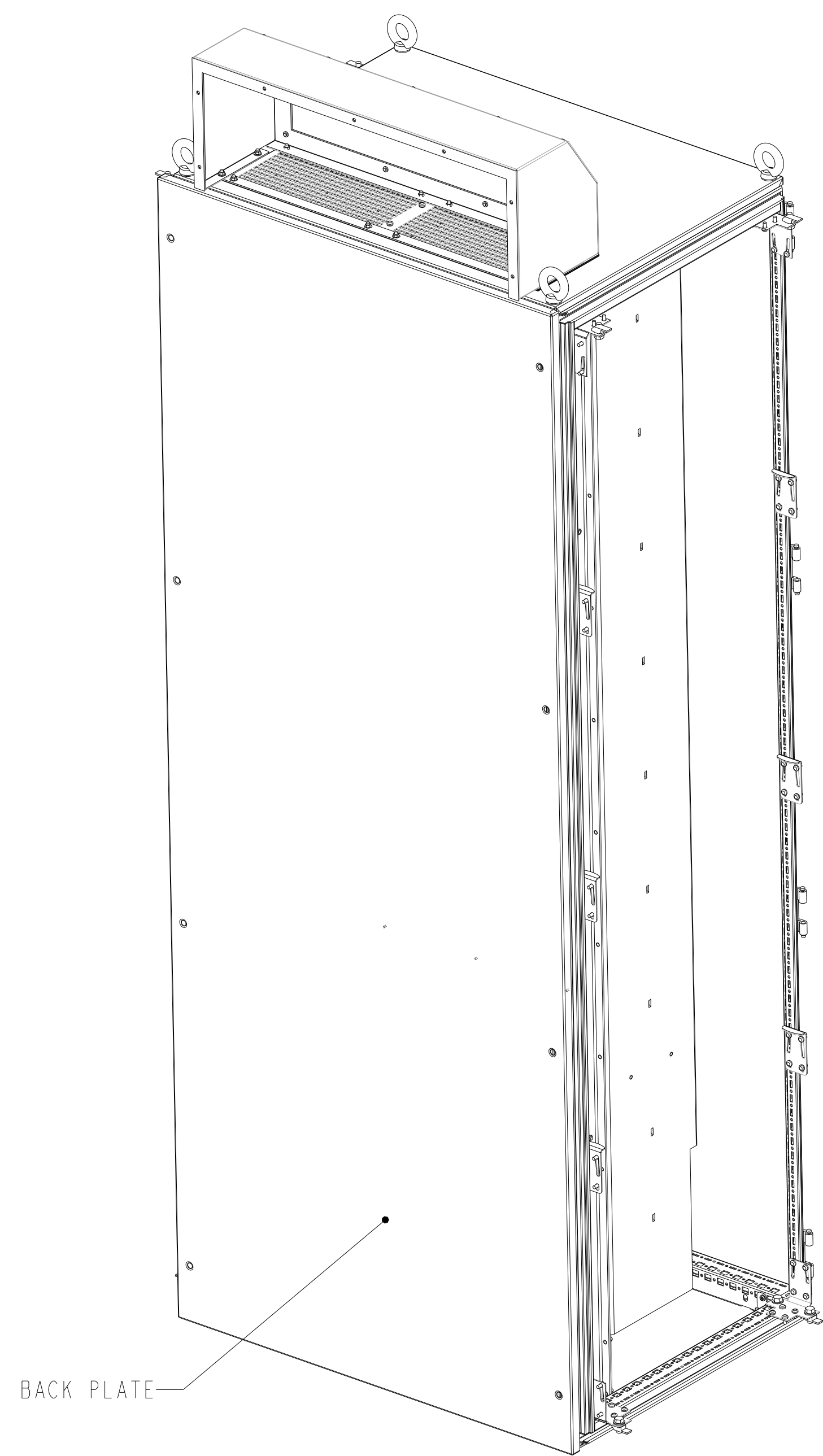

- STEPS:
1. INSTALL TOP AND BOTTOM COMPONENTS AS SHOWN IN SHEET 1.
  2. REMOVE BACK PLATE.
  3. REMOVE 177G5046 AND 177G5045.
  4. MAKE CUTOUT ON BACKPLATE AS SHOWN IN SHEET 3.
  5. RE-INSTALL BACKPLATE.
  6. INSTALL 177G6838 GASKET.

002

TITLE			
KIT, F18, LHD, IP54, BACKWALL COOLING			
SIZE D	MODEL LHD330-IP54-V2	REV 003	
SCALE 0.250	DRAWING NO. 176F3534	SHEET 2 OF 4	

8

7

6

5

4

3

2

1

8

7

6

5

4

3

2

1

D

C

B

A

D

C

B

A

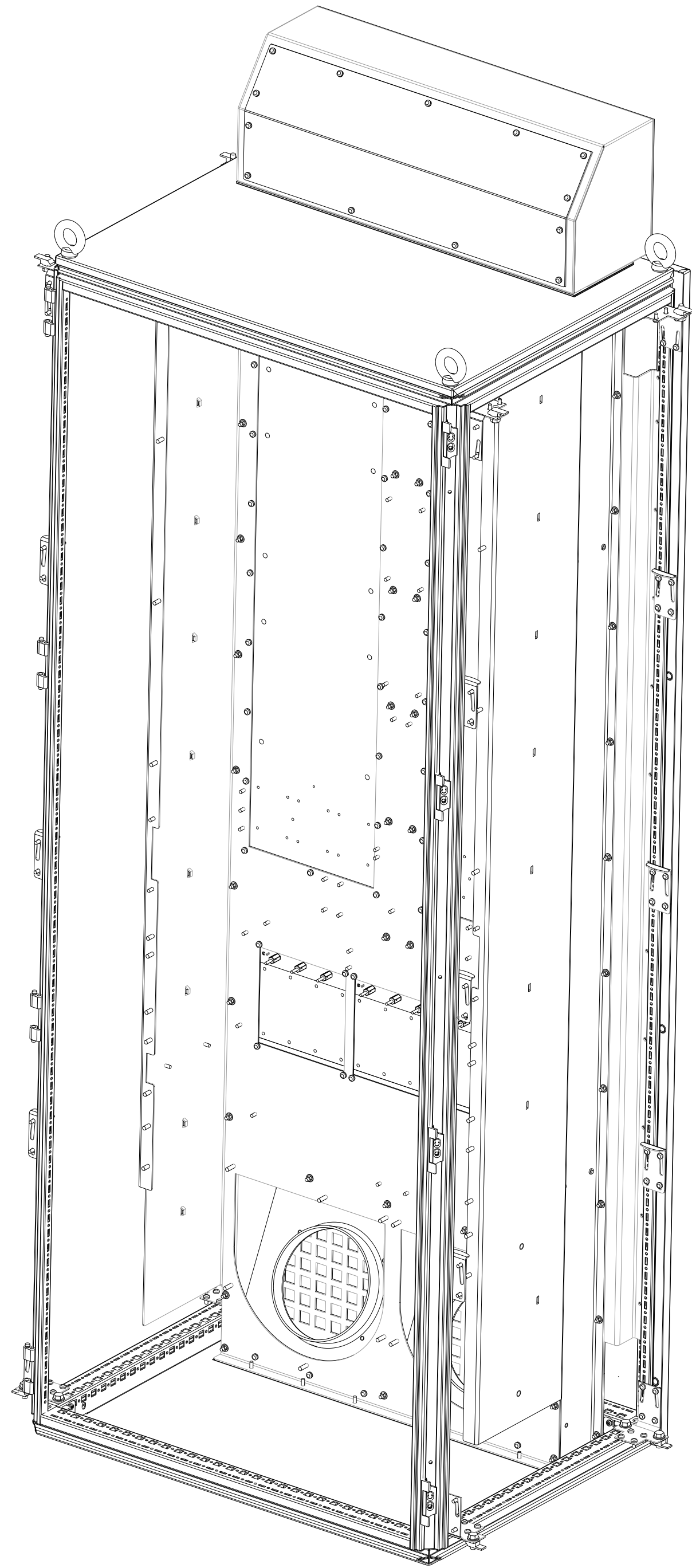
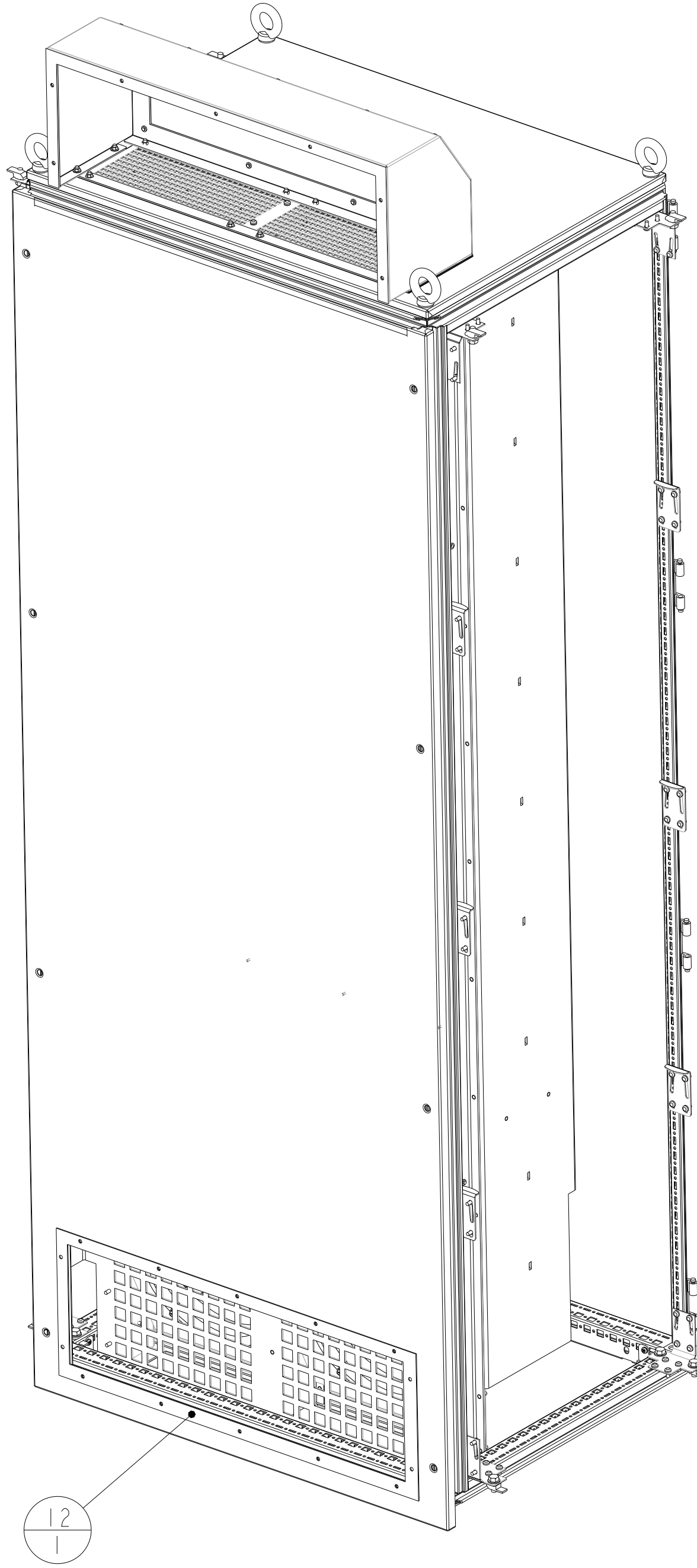
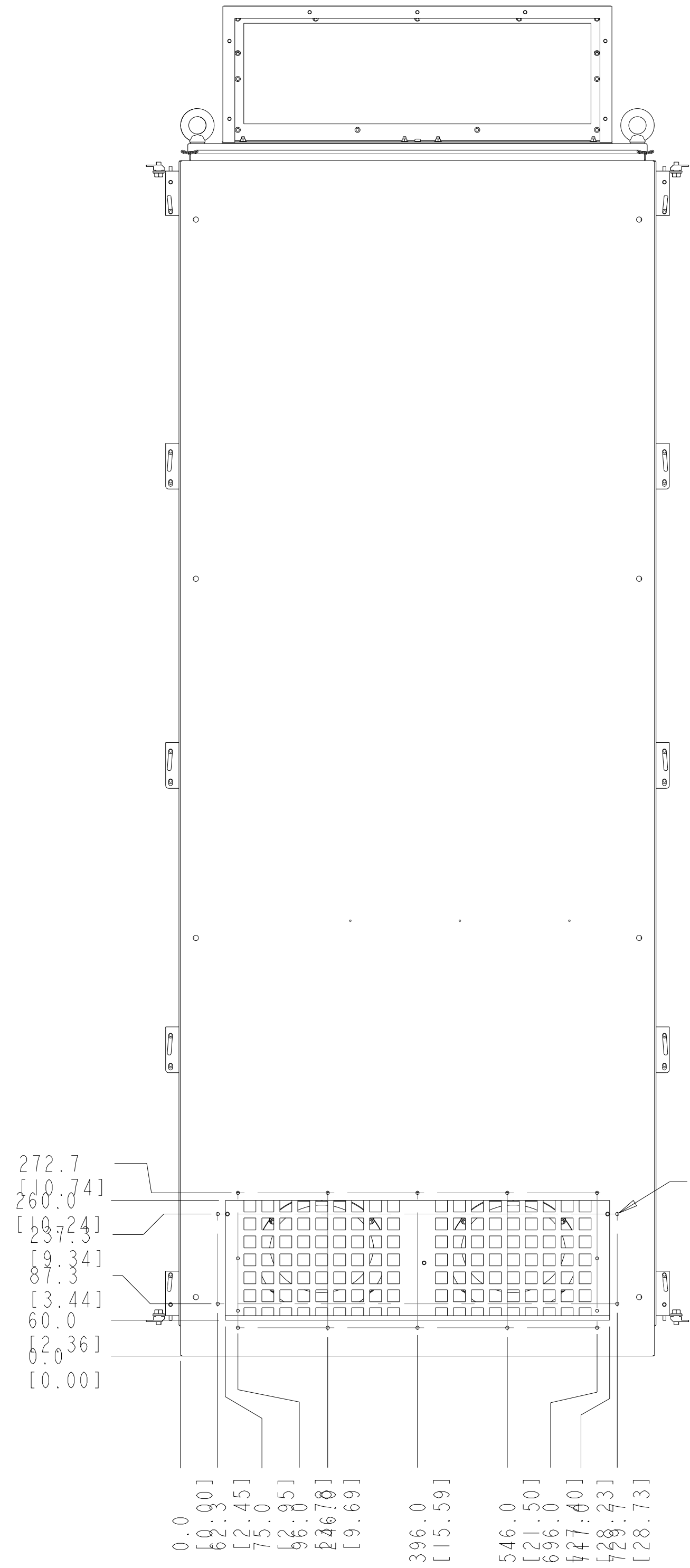

TITLE		
KIT, F18, LHD, IP54, BACKWALL COOLING		
SIZE	MODEL	REV
D	LHD330-IP54-V2	003
SCALE	DRAWING NO.	SHEET
0.250	176F3534	3 OF 4

8

7

6

5

4

3

2

1

8

7

6

5

4

3

2

1

D

D

C

C

B

B

A

A

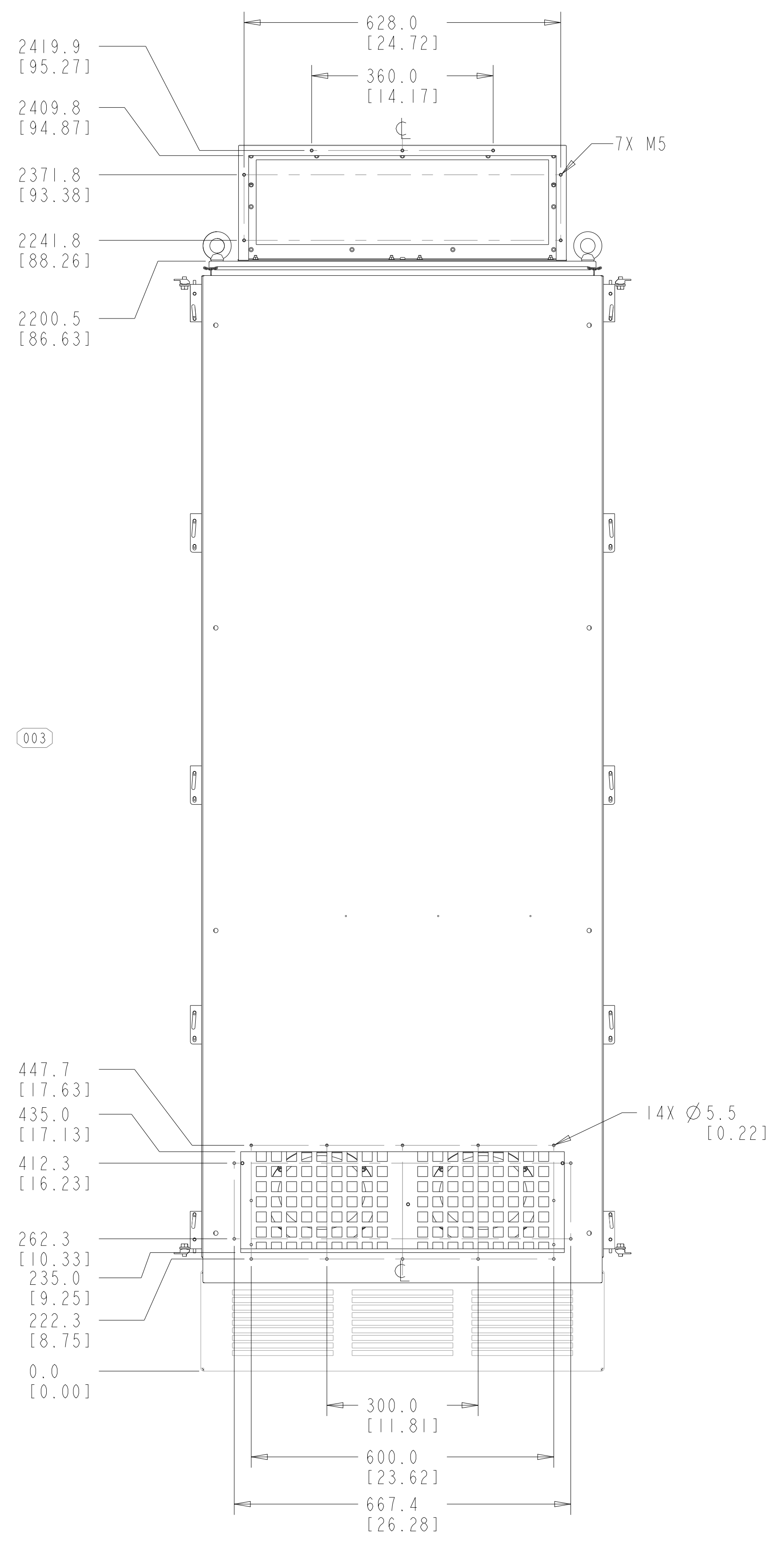

TITLE		
KIT, F18, LHD, IP54, BACKWALL COOLING		
SIZE	MODEL	REV
D	LHD330-IP54-V2	003
SCALE	DRAWING NO.	SHEET
0.250	176F3534	4 OF 4

8

7

6

5

4

3

2

1